

# CIVIL AVIATION ACT

## ARRANGEMENT OF SECTIONS

### PART I

#### *Control of Air Navigation*

#### SECTION

1. Control and Supervision of civil aviation.

### PART II

#### *The Nigerian Civil Aviation Authority*

2. Establishment of the Nigerian Civil Aviation Authority.

### PART III

#### *The Governing Board of the Authority*

3. Membership of the Governing Board.
4. Tenure of Office.
5. Cessation of Office.
6. Allowances, expenses, etc., of Chairman and members.
7. Functions of the Board.

### PART IV

#### *Staff of the Authority*

8. Director-General of the Authority.
9. Appointment of secretary and other staff by the Board.
10. Conflict of interests.
11. Pensions; Act No. 2, 2004.

### PART V

#### *Financial Provisions*

12. Air ticket and cargo sales charge.
13. Fund of the Authority.
14. Expenditure by the Authority.
15. Power to accept gifts.
16. Power to borrow and invest.
17. Exemption from tax.
18. Duty to be Financially Prudent.

### PART VI

*Information, Notices, etc.*

- 19. Power to request for information.
- 20. Restriction on disclosure of information.
- 21. Service of notices.
- 22. Service of documents.

PART VII

*Miscellaneous Provisions.*

- 23. Power to acquire land
- 24. Limitation of suits against the Authority.
- 25. Restriction on execution against property of the Authority.
- 26. Indemnification of Officers.

PART VIII

*Investigation and Enforcement*

- 27. Power to investigate, impose fines and enforce.
- 28. Directions by the Minister.
- 29. Investigation of accidents/Accident Investigation Bureau.

PART IX

*The Authority's Power to regulate Civil Aviation*

- 30. Power to regulate air navigation.

PART X

*Functions of the Authority*

- 31. Functions of the Authority.

PART XI

*Control of air Transport Undertaking*

- 32. Licensing of air transport undertakings.
- 33. Eligibility for licenses, permits, etc.
- 34. Air Operator Certificate (AOC) and other safety certificates.
- 35. Variation, suspension and revocation of licenses, permits, etc.
- 36. Supplementary Provisions relating to Licenses, permits, etc.
- 37. General duties in relation to licensing functions of the Authority.

PART XII

*Provision of Aerodromes, Control of Land for Aviation Purposes, etc.*

38. Power of Minister to approve the establishment aerodromes.
39. Eligibility for an aerodrome license.
40. Duty of the Authority to consider environmental factors when licensing aerodromes. .
41. Fixing by Reference to noise factors, the charges for using licensed aerodromes.
42. Requirements for approval of aerodrome security programme.
43. Requirements for approval of airline security programme.
44. Security surveys, audits, tests and inspections.
45. Security checks of persons and baggage.
46. Obstructions near aerodromes.
47. Trespass on aerodromes, etc.

PART XIII

*Special Provisions as to Trespass, Nuisance, Salvage and Patents, etc*

48. Carriers' Liability.
49. Actions in trespass, nuisance and damage from aircraft.
50. Application to aircraft of law of wreck and salvage.
51. Patent claims.
52. Infringement of patent.
53. Detention of aircraft.

PART XIV

*Offences*

54. Offences.
55. Dangerous flying.
56. Hijacking and Interference.
57. Offences of endangering safety, destroying or damaging of an aircraft in flight, etc.
58. Prohibition of unruly and indecent conduct.
59. Offences at aerodromes.
60. Destruction of, or damages to, air navigation and other facilities.
61. Duties of operators and personnel.
62. Transportation of dangerous goods.
63. Federal High Court to try offences.

PART XV

*General*

64. Power of the Authority to make rules for protecting public health.
65. Emergency powers for protecting public health.
66. Power of Minister to make orders in emergency.
67. Designation of essential Services.
68. Bilateral exchanges of Safety oversight responsibilities.
69. Regional cooperative aviation safety agreement.
70. Aviation safeguards.
71. Compensation schemes for passengers and other allied aviation services consumers.

- 72. Regulation of sale, distribution and provision of allied services.
- 73. Application of certain conventions.
- 74. Insurance.
- 75. Air services agreement.
- 76. Periodic publication of aviation policy.
- 77. Repeals and savings provisions.
- 78. Definitions.
- 79. Short Title.

SCHEDULES

FIRST SCHEDULE

*Convention for the Suppression of Unlawful Seizure of Aircraft*

SECOND SCHEDULE

*Convention for the Unification of certain Rules relating to International Carriage by Air*

(Montreal, 1999)

THIRD SCHEDULE

*Modification to the Convention for the Unification of certain Rules relating to International Carriage by Air*

FOURTH SCHEDULE

*Convention on International Recognition of Rights in Aircraft, 1948*

FIFTH SCHEDULE

SIXTH SCHEDULE

*Supplementary Provisions with respect to the Proceedings of the Board and other matters*

---

**An Act to repeal the Civil Aviation Act Cap. 51 Laws of the Federation of Nigeria, 1990 as amended and to re-enact the Civil Aviation Act to provide for the regulation of Civil Aviation, establishment of the Nigerian Civil Aviation Authority; and for related matters**

[Commencement]

[14th November, 2006]

ENACTED by the National Assembly of the Federal Republic of Nigeria

PART I

## *Control of Air Navigation*

### **1. Control and supervision of civil aviation**

The Minister shall be responsible for the formulation of policies and strategies for the promotion and encouragement of Civil Aviation in Nigeria and the fostering of sound economic policies that assure the provision of efficient and safe services by air carriers and other aviation and allied service providers as well as greater access to air transport in a sustainable manner and to assist with ensuring that Nigeria's obligations under international agreements are implemented and adhered to.

## PART II

### *The Nigerian Civil Aviation Authority*

### **2. Establishment of the Nigerian Civil Aviation Authority**

(1) There is established a body to be known as the Nigerian Civil Aviation Authority (in this Act referred to as "the Authority").

(2) The Authority:

- (a) shall be a body corporate with perpetual succession and a common seal;
- (b) may sue or be sued in its corporate name; and
- (c) may acquire, hold or dispose of property whether moveable or immovable.

## PART III

### *The Governing Board of the Authority*

### **3. Membership of the Governing Board**

(1) The Authority shall have a Governing Board (in this Act referred to as "the Board") which shall consist of:

- (a) a chairman;
- (b) one representative not below the rank of a Director of the following Ministries
  - (i) the Federal Ministry of Aviation or the Ministry for the time being responsible for Aviation,
  - (ii) the Federal Ministry of Defence or the Ministry for the time being responsible for Defence, and
  - (iii) the Federal Ministry of Communications or the Ministry for the time being responsible for Communications,

(c) four persons with cognate experience in aviation; and

(d) the Director-General of the Authority

(2) The Chairman and members of the Board other than the Director-General shall be appointed on part time basis by the President on the recommendation of the Minister.

(3) The Chairman and members of the Board including the Director-General, shall be persons of recognised expert knowledge, qualification and experience of not less than ten years in one or more of the following fields

(a) Aeronautical Engineering;

(b) Aviation Law;

(c) Air Transport Management;

(d) Aerodrome Engineering;

(e) Aircraft Piloting; or

(f) Telecommunications.

(4) The supplementary provisions set out in the Sixth Schedule to this Act shall have effect with respect to the proceedings of the Board and the other matters contained therein.

#### [Sixth Schedule]

#### **4. Tenure of Office**

A member of the Board, other than the Director-General, shall hold office:

(a) for a term of 4 years in the first instance and may be re-appointed for a further term of 4 years and no more; and

(b) on such terms and conditions as may be specified in the letter of appointment.

#### **5. Cessation of Office**

(1) Notwithstanding the provisions of Section 4 of this Act, a person shall cease to hold office as a member of the Board if

(a) he becomes bankrupt, suspends payment or compounds with his creditors

(b) he is convicted of a felony or any offence involving dishonesty or fraud

(c) he becomes of unsound mind or is incapable of carrying on his duties

(d) he is guilty of a serious misconduct in relation to his duties :

(e) in the case of a person possessed of professional qualification, he is disqualified or suspended from practising his profession in any part of the world by an order of a competent authority : or

(f) he resigns his appointment by a letter addressed to the President.

(2) A member of the Board, other than the Director-General, may be removed as the President; on the recommendation of the Minister if the Minister is satisfied that it is not in the interest of the Authority or the public for the member to continue in office.

(3) If a member of the Board ceases to hold office for any reason whatsoever before the expiration of the term for which he is appointed, another person representing the same interest as that member shall be appointed to the Board for the unexpired term.

#### **6. Allowances, expenses, etc., of Chairman and members**

The Chairman and members of the Board shall be paid such allowances, expenses and benefits in accordance with extant Federal Government Financial Guidelines.

#### **7. Functions of the Board**

The Board shall-

(a) fix terms and conditions of service including remuneration of the employees of the Authority in accordance with the provision of Salary and Wages Commission;

(b) receive and review annual reports from the Management of the Authority and submit same to the President and the National Assembly, through the Minister, not later than 30th June in each year and the report shall be on the activities of the Authority during the immediately preceding calendar year and shall include a copy of the audited accounts of the Authority for that calendar year;

(c) submit not later than 30th September in each year to the Minister an estimate of the expenditure and income of the Authority for the next succeeding year; and

(d) cause to be kept, proper accounts of the Authority in respect of each year and proper records in relation thereto and shall cause the accounts to be audited not later than 6 months after the end of each year by authority appointed from the list and in accordance with the guidelines supplied by the Auditor-General of the Federation.

### **PART IV**

#### *Staff of the Authority.*

#### **8. Director-General of the Authority**

(1) There shall be for the Authority a Director-General who shall be appointed by the President, on such terms and conditions as stipulated in the Act, subject to the confirmation by the Senate.

(2) The Director-General shall be primarily responsible for the fostering of the safety of Civil Aviation in Nigeria and shall be

- (a) the chief executive and accounting officer of the Authority
- (b) responsible for the day-to-day administration of the Authority
- (c) appointed for a term of 5 years in the first instance and may be reappointed for a further term of 5 years and no more : and
- (d) a person who possesses relevant and adequate professional qualification and shall have been so qualified for a period of not less than 15 years.

(3) The Director-General may be suspended or removed from office by the president if he

- (a) has demonstrated inability to effectively perform the duties of his office :
- (b) has been absent from 5 (five) consecutive meetings of the Board without the consent of the Chairman unless he shows good reason for such absence;
- (c) is guilty of serious misconduct in relation to his duties as Director-General;
- (d) in the case of a person possessed of professional qualifications, he is disqualified or suspended from practising his profession in any part of the world by an order of a competent authority; or
- (e) is guilty of a conflict of interest as stipulated in Section 10 of this Act.

(4) The Director-General shall not be removed from office except in accordance with the provisions of this Act.

### **9. Appointment of secretary and other staff by the Authority**

(1) The Board shall appoint for the Authority a Secretary who shall

- (a) be a legal practitioner and shall have been so qualified for a period of not less than 12 years;
- (b) conduct the correspondence of the Board and keep the official seal and records of the Authority; and
- (c) perform such other functions as the Board or the Director-General, may from time to time assign to him.

(2) The Authority shall appoint such number of employees as may be expedient and necessary for the proper and efficient performance of its functions under this Act.

(3) Notwithstanding the provisions of subsections (1) and (2) of this section, the Authority shall have power to appoint either directly or on secondment from any public service in the Federation or of a



State, such number of staff as may, in its opinion be required to assist it in the discharge of any of the Authority's functions under this Act.

(4) Nothing in subsection (3) of this section shall preclude the Authority from appointing persons from outside the public service of the Federation of a State.

#### **10. Conflict of interest**

(1) The Minister of Aviation, Members of the Governing Board, Director-General and employees of the Ministry of Aviation and the Authority shall not control, manage or operate any aviation enterprise while in office.

(2) Any of the persons specified in subsection 1, having a financial interest in any aviation enterprise shall make full disclosure of such interest to their respective appointing authorities.

(3) Any of the persons mentioned in subsection (1) above is prohibited from participating in any action or decision that may, whether directly or indirectly, affect their financial interest(s) in any aviation enterprise.

#### **11. Pensions Act No. 2, 2004**

(1) Service in the Authority shall be approved service for the purpose of the Pension Reform Act or any other Act for the time being in force.

[2004 No. 2.]

(2) The officers and other persons employed in the Authority shall be entitled to pensions, gratuities and other retirement benefits in conformity with provisions of the Pensions Reform Act.

(3) Nothing in subsections (1) and 2) of this section shall prevent the appointment of a person to any office on terms which may preclude the grant of a pension, gratuity or other retirement benefits in respect of that office.

(4) For the purposes of the application of the provisions of the Pensions Act, any power exercisable there under by a Minister or other authority (other than the power to make regulations the Pensions Act) is hereby vested in and shall be exercisable solely by the Board.

### **PART V**

#### *Financial Provisions*

#### **12. Air ticket and cargo sales charge**

(1) There shall continue to be a 5% air ticket contract, charter and cargo sales charge to be collected by the airlines and paid over to the Authority.

(2) The Air Ticket and Cargo Sales charge may be reviewed by the Authority in consultation with the stakeholders from time to time.

(3) Funds accruing from the said charge shall be shared in the following manner:

- (a) the Nigeria Civil Aviation Authority - 58%;
- (b) Nigerian Airspace Management Agency - 23%;
- (c) Nigerian Meteorological Agency-9%;
- (d) Nigerian College of Aviation Technology- 7%;
- (e) Accident Investigation Bureau-3%;

Provided that if any of the above listed agencies is privatized it shall immediately cease to share in the funds as aforesaid and the Minister may by regulation specify how the share of such privatized agency shall be applied or disbursed.

### **13. Fund of the Authority**

There shall be established and maintained for the Authority a fund into which shall be paid and credited-

- (a) all subventions and budgetary allocation from the Government of the Federation;
- (b) all fees and funds in respect of services provided by the Authority, and accruing from the grant of -
  - (i) Air Travel Organizer's License,
  - (ii) Air Transport License/Airline Operating Permit/Permit for non-commercial flights,
  - (iii) Air Operator Certificate,
  - (iv) calibration of navigational aids where applicable,
  - (v) personnel licenses,
  - (vi) 58% of the air ticket and cargo and charter sales charge imposed in section 12 of this Act,
  - (vii) Approved Maintenance Organization (AMO) approval,
  - (viii) Aircraft registration and certification,
  - (ix) Certificate of Airworthiness (issue and renewal),
  - (x) rental of property, plant and equipment,
  - (xi) medical examination fees, where applicable,

- (xii) proceeds from sales of information and publications,
- (xiii) contract registration fees,
- (xiv) any license, certificates, permits, contracts or leases issued pursuant to the provisions of this Act,
- (xv) registration of legal instruments and interests,
- (xvi) Aerodrome, Heliport and Helipad Operating License,
- (xvii) aviation height clearance,
- (xviii) Aviation Training Organizations and
- (xix) registration of agencies.

(c) all fines payable for violation of civil aviation regulations, rules and orders;

(d) all sums accruing to the Authority by way of gifts, endowments, bequests, grants or other contributions by persons and organizations;

(e) returns on investments;

(f) foreign aid and assistance; and

(g) all other sums which may, from time to time, accrue to the Authority.

#### **14. Expenditure by the Authority**

The Director-General of the Authority shall, from time to time, apply the funds of the Authority to-

(a) the cost of administration and maintenance of the Authority;

(b) publicise and promote the activities of the Authority;

(c) pay allowances, expenses and other benefits of members of the Board and Committees of the Board;

(d) pay the salaries, allowances and benefits of employees of the Authority;

(e) pay other overhead allowances, benefits and other administrative costs of the Authority; and

(f) undertake such other activities as are connected with all or any of the functions of the Authority under this Act.

#### **15. Power to accept gifts**

(1) The Authority may accept gifts of land, money or other property on such terms and conditions, if any, as may be specified by the person or organization making the gift.

(2) The Authority shall not accept any gift if the conditions attached by the person or organizations making the gift are inconsistent with the functions of the Authority under this Act.

#### **16. Power to borrow and invest**

(1) Subject to all applicable laws, the Board may, from time to time, borrow by overdraft or otherwise, such money as the Authority, may require for the performance of its functions under this Act.

(2) The Board shall not, without the approval of the President borrow money, which exceeds, at any time, the limit set by the Government of the Federation.

(3) Notwithstanding subsection (1) of this section, where the sum to be borrowed is in foreign currency, the Board shall not borrow the sum without the prior approval of the President

(4) The Board may, subject to the provisions of this Act and the conditions of any trust in respect of any property, invest all or any of its funds in accordance with any general guidelines approved by the President.

(5) The Board may invest funds in such securities as it deems fit and proper.

#### **17. Exemption from tax**

(1) The Authority shall be exempted from the payment of tenement rates and income tax.

(2) The provision of any enactment relating to the taxation of companies or trust funds shall not apply to the Authority.

#### **18. Duty to be financially prudent**

(1) The Director-General shall conduct the Authority's affairs with prudence and due diligence to ensure that the Authority does not become insolvent.

(2) The Authority shall strive to recover the whole of its costs and to achieve reasonable returns on capital and investment.

### **PART VI**

#### *Information, Notices, etc.*

#### **19. Power to Request for Information**

(1) For the purpose of obtaining required information for the proper discharge of the functions conferred upon it by this Act, any authorized officer of the Authority may by notice, in writing-

(a) require any person who undertakes the business of air transport including carriage of passengers or goods in an aircraft for reward, to furnish such information relating to such business and flights as may be specified in the notices; and

(b) specify the times and the form and manner in which, any information required under paragraph (a) of this subsection shall be furnished.

(2) In carrying out the functions conferred on the Authority, an authorized officer of the Authority shall have unrestricted access to the business premises, aircraft, structures and other apparatus used by any operator for the purpose of air transport or related operations.

(3) In this section, “**authorised officer**” means the Director-General or any other officer of the Authority specifically or generally authorised by the Director-General to carry out the functions of the Authority under this Act.

## **20. Restriction on Disclosure of Information**

(1) No estimates, returns or information relating to an air transport undertaking obtained under the foregoing provisions of this Act, shall, without the prior consent in writing of the person carrying on the undertaking which is the subject of the estimates, returns, or information, be disclosed except -

(a) in accordance with directions given by the Authority for the purpose of the exercise of any of its functions under this Act; or

(b) for the purposes of any proceedings under this Act.

(2) Any person who discloses any estimates, returns or any information in contravention of subsection 1 of this section, commits an offence and is liable on conviction to imprisonment for a term not less than 1 month or a fine not less than ₦25, 000.00 or both.

## **21. Service of Notices**

(1) Any notice required or authorised under this Act to be served on any person may be served either by

(a) delivering it to the person or his agents or servants;

(b) leaving it at the person’s proper address; or

(c) posting it to the person’s principal office by registered post or courier.

(2) Any notice required or authorised to be served upon a body corporate shall be deemed to have been duly served if it is served on a director of or the Secretary to the body corporate.

(3) For the purposes of this section, the proper address of any person on whom such a notice is to be served shall-

(a) in the case of a body corporate, be that of the registered or principal office of the body corporate; and

(b) in any other case, be the last known address of the person.

## **22. Service of Documents**

A notice, summons or other document required or authorised to be served upon the Authority under the provisions of this Act shall be served by delivering same to the office of the Director-General of the Authority situate at the Headquarters of the Authority.

## PART VII

### *Miscellaneous Provisions*

#### **23. Power to Acquire Land**

(1) The Authority, may subject to the Land Use Act, acquire any land for the purpose of discharging its functions under this Act.

(2) If there is any hindrance in the acquisition of any land by the Authority under this Act (including any failure by the Authority to reach an agreement as to the amount to be paid in respect of the acquisition), the Authority may apply to the Minister for a declaration under subsection (3) of this section.

(3) The Minister on receiving an application from the Authority and after such enquiry as he may think fit, may request the Governor of the State in which the land is situated to declare that the land is required for the service of the Authority and accordingly for an over-riding public purpose.

(4) Where a declaration is made under subsection (3) of this section, the land to which the declaration relates shall be deemed to be land required for the public purpose of the Federation within the meaning of the Land Use Act and the Authority shall acquire the land accordingly.

(5) Where a declaration has been made under subsection (3) of this section in respect of any land and -

(a) the land has been acquired pursuant to subsection (4) of this section; or

(b) the Governor of the State where the land is situated is satisfied that there are no rights subsisting in respect of the land,

the Governor may vest the land in the Authority by issuing a certificate of occupancy in respect thereof, in favour and in the name of the Authority.

(6) The compensation, if any, payable under the Land Use Act for the revocation of any rights relating to the land, where applicable, shall in the first instance be paid by the Federal Government, but the Authority shall refund to the Federal Government any compensation so paid and all incidental expenses incurred by the Government.

(7) A plan of any land referred to in subsection (2) of this section -

(a) containing measurements of the boundaries of the land;

(b) showing the relationship of the land to any sufficient identifying mark(s); and

(c) signed by a licensed surveyor and the Director-General,

shall be sufficient description of the land for the purpose of an application under that subsection.

#### **24. Limitation of suits against the Authority**

(1) Notwithstanding anything contained in any other law or enactment, no suit shall lie against the Authority, a member of its Board, its Director-General, or any other employee of the Authority for any act done in pursuance or execution of any public duty under this Act or any law or enactment, or in respect of any alleged neglect or default in the execution of any public duty under this Act or such law or enactment, unless it is commenced within one (1) year next after the act, neglect or default complained of, or in the case of a continuance of damage or injury, within one (1) year after the ceasing thereof.

(2) No suit shall be commenced against the Authority, a member of its Board, its Director-General or any employee of the Authority, before the expiration of a period of one (1) month after written notice of intention to commence the suit shall have been served upon the Authority by the intending plaintiff or his agent; and the notice shall clearly and explicitly state the cause of action, the particulars of the claim, the name and place of abode of the plaintiff and the relief sought.

#### **25. Restriction on Execution against Property of the Authority**

(1) In any action or suit against the Authority, no execution or attachment or process in the nature thereof save a garnishee process shall be issued against the Authority.

(2) Any sum of money, which may by the Judgment of any court be awarded against the Authority, shall, subject to any direction given by a competent court where notice of appeal of the said judgment has been given, be paid from the fund of the Authority.

#### **26. Indemnification of Officers**

A member of the Board, the Director-General or employee of the Authority shall be indemnified by the Authority against any civil proceeding brought against him arising from the lawful discharge of any of the functions or the exercise of any of the powers conferred on the Authority under this Act or any other enactment.

### **PART VIII**

#### *Investigation and Enforcement*

#### **27. Power to investigate, impose fines and enforce**

(1) The Authority shall have power to carry out investigations into complaints and occurrences, save for accidents and serious incidents, after due notice to the person concerned.

(2) If the Authority is satisfied after such hearing that such person is violating any provisions of this Act, regulations, rules or orders, as the case may be, it shall by order require the person to take such action

consistent with the provision of this Act, regulations, rules or orders as may be necessary in the opinion of the Authority to prevent further violation of the provisions of this Act, regulations, rules or orders.

(3) The Authority shall have power to take all steps reasonably necessary, including the power to ground any aircraft and to seal the premises of any air transport service provider or provider of allied aviation service, in order to ensure compliance with the provisions of this Act and the regulations, rules and orders made pursuant to it.

## **28. Directions by the Minister**

(1) The Minister may after consultation with the Authority give such directions, not inconsistent with the provisions of this Act, to the Authority on matters of policy-

(a) in the interests of national security;

(b) in connection with any matter appearing to him to affect the relations of Nigeria with a country or territory outside Nigeria;

(c) in order to discharge or facilitate the discharge of an obligation binding on Nigeria by virtue of its being a member of an international organization or a party to an international agreement;

(d) in order to obtain or facilitate the attainment of any other object of which is in his opinion appropriate in view of the fact that Nigeria is a member of an international organization or a party to an international agreement; or

(e) in order to enable Nigeria become a member of an international organization or a party to an international agreement.

(2) The Authority in the exercise of its functions and powers shall be guided by such directions.

(3) The Authority shall furnish the Board with such information or facilities for obtaining information with respect to its activities as the Minister may from time to time require.

## **29. Investigation of Accidents/ Accident Investigation Bureau**

(1) There is established an Accident Investigation Bureau hereinafter in this Act referred to as "the Bureau" which shall be a body corporate with power to sue and be sued in its corporate name except for matters associated with accident reports and to acquire, hold and dispose of property whether movable or immovable.

(2) The Bureau shall be an autonomous agency reporting to the President through the Minister.

(3)(a) The Bureau shall be headed by a Commissioner of Accident investigation who shall be appointed by the President on the recommendation of the Minister.

(b) The Commissioner of Accident Investigation, who shall be the Chief Executive Officer of the Bureau, shall be appointed for a period of four (4) years renewable once for another period of four (4) years.



(4) The Commissioner of Accident Investigation shall possess cognate experience and qualification in air accident investigation of not less than 12 years.

(5) There shall be established for the Bureau a fund into which shall be paid and credited-

(a) all subventions and budgetary allocation from the Government of the Federation;

(b) 3% of the air ticket contract charter and cargo sales charge imposed in Section 12 of this Act;

(c) all sums accruing to the Bureau by way of gifts, endowments, bequests, grants or other contributions by persons and organizations;

(d) returns on investments;

(e) foreign aid and assistance; and

(f) all other sums which may, from time to time, accrue to the Bureau.

(6) The services of all persons currently employed in the Accident Investigation and Prevention Bureau of the Ministry of Aviation are hereby transferred to the Bureau,

(7) The Commissioner of Accident Investigation may with the approval of the Minister recruit such staff as is necessary for the execution of its functions under this Act.

(8) There shall be appointed for the Bureau a legal adviser who shall be a Legal Practitioner of not less than 10 years post call experience.

(9) The Bureau in the execution of its functions under this Act shall follow and adhere to the regulations for accident investigation made by the Minister.

(10) The Minister may make regulations providing for the investigation of any accident or incident arising out of or in the course of air navigation and either occurring in or over Nigeria or occurring to Nigerian aircraft elsewhere.

(11) Without prejudice to the generality of subsection (10) of this section, the regulations made thereunder may in particular contain provisions -

(a) requiring notice to be given of any such accident or incident as aforesaid in such manner and by such persons as may be prescribed;

(b) applying for the purpose of investigations held with respect to any such accident or incident any of the provisions of any law in force in Nigeria relating to the investigation of deaths or accidents;

(c) prohibiting, pending investigation, access to or interference with aircraft to which an accident or incident has occurred and authorising any person, so far as may be necessary for the purposes

of an investigation, to have access to, examine, remove, take measures for the preservation of, or otherwise deal with, any such aircraft;

(d) authorising or requiring the cancellation, suspension, endorsement or surrender of any license or certificate granted in Nigeria in pursuance of this Act or any regulation, or the withdrawal or suspension of any validation conferred in Nigeria of a license granted by a competent authority elsewhere, where it appears on investigation that the license, certificate or validation ought to be so dealt with, and requiring the production accordingly of any such license or certificate;

(e) incorporating the provisions of Annex 13 to the Convention on International Civil Aviation,

(12) The sole objective of the investigation of an accident or serious incident under this Act shall be the prevention of accidents and incidents and it shall not be the purpose of such an investigation to apportion blame or liability.

(13) On the basis of the findings of accident investigation, the Authority shall be informed and the Director-General shall take corrective actions that, in the judgment of the Authority, will prevent similar accidents in the future.

(14) Notwithstanding the provisions of the Evidence Act, the contents of an air accident investigation report made pursuant to the provisions of this Act and regulations made there-under, shall not be admissible in evidence as to form the basis of liability in any criminal or civil proceedings.

[Cap. E14]

## PART IX

### *The Authority's Power to regulate Civil Aviation.*

#### **30. Power to regulate air navigation**

(1) The Authority may by regulation make such provision as expedient

(a) for carrying out the Convention on International Civil Aviation (in this section referred to as "the Convention") concluded at Chicago on the 7th day of December, 1944, any Annex to the Convention which relates to international standards and recommended practices and is adopted in accordance with the Convention, and any amendment of the Convention or of any such Annex which is made in accordance with the Convention;

(b) for carrying out any other treaty or agreement in the field of civil aviation to which Nigeria is a party; and

(c) generally for regulating air navigation.

(2) Without prejudice to the generality of subsection (1) of this section, the powers conferred therein shall include power to make regulations -

- (a) for the registration of aircraft in Nigeria;
- (b) for the prohibition of aircraft from flying unless certificates of airworthiness issued or validated under the regulations are in force with respect to them and except upon compliance with such conditions as to maintenance and repair as may be prescribed;
- (c) for the licensing, inspection and regulation of aerodromes, access to aerodromes and places where aircraft have landed, for the inspection of aircraft factories, and for prohibiting or regulating the use of aerodromes which are not licensed in pursuance to the regulations;
- (d) for prohibiting persons from engaging in, or being employed in or in connection with, air navigation in such capacities as may be prescribed unless they satisfy the prescribed requirements, and for the licensing of persons employed at aerodromes in the inspection, testing or supervision of aircraft;
- (e) as to the conditions under which, and in particular the aerodromes to or from which, aircraft entering or leaving Nigeria may fly, and as to the conditions, under which aircraft may fly from one part of Nigeria to another;
- (f) as to the conditions under which passengers and goods may be carried by air and under which aircraft may be used for other gainful purposes, and for prohibiting the carriage by air of goods of such class or classes as may be prescribed;
- (g) for minimizing or preventing interference with the use or effectiveness of apparatus used in connection with air navigation, and for prohibiting or regulating the use of such apparatus and the display of signs and lights liable to endanger aircraft;
- (h) generally for securing the safety, efficiency and regularity of air navigation and the safety of aircraft and of persons and property carried in aircraft, and for preventing aircraft from endangering other persons and property;
- (i) for requiring persons engaged in, or employed in or in connection with, air navigation to supply meteorological information for the purposes of air navigation;
- (j) for regulating the making of signals and other communications by or to aircraft and persons carried in aircraft;
- (k) for instituting and regulating the use of a civil air ensign and any other ensign established by the Authority for purposes connected with air navigation;
- (l) for prohibiting aircraft from flying over such areas in Nigeria as may be prescribed;
- (m) for applying the enactments relating to customs in relation to aerodromes and to aircraft and to persons and property carried in aircraft;
- (n) as to the manner and conditions of the issue, validation, renewal, extension or variation of any certificate, license or other document required by the regulations (including the examinations and tests

to be undergone), and as to the form, custody, production, cancellation, suspension, endorsement and surrender of any such document;

(o) for the registration of births and deaths occurring in aircraft and of particulars of persons missing from the aircraft;

(p) for regulating the charges that may be made in respect of air traffic control and meteorological services and for the use of aerodromes licensed under the regulations and for services provided at such aerodromes;

(q) for specifying the fees to be paid in respect of the issue, validation, renewal, extension or variation of any certificate, license or other document or the undergoing of any examination or test required by virtue of the regulations and in respect of any other matter in respect of which it appears to the Authority to be expedient for the purposes of the regulations to charge fees;

(r) for exempting from the provisions of the regulations or any of them any aircraft or persons or classes of aircrafts or persons; as to the conditions under which noise and vibration may be caused by aircraft on aerodromes provided that no action shall lie in respect of nuisance by reason only of the noise and vibration caused by aircraft on an aerodrome so long as the provisions of the regulations in force as respects aerodromes are complied with;

(s) as to the circumstances and conditions under which it would be permissible to use aircraft for aerial advertisement and for regulating advertisements by air transport, aerodrome and air traffic control service providers;

(t) regarding the design, construction and modification of aircraft and all other matters connected with the design, construction and maintenance of aircraft; and

(u) regarding security control and screening to which passengers and baggage (whether accompanied or unaccompanied) would be subjected to before boarding or being laid on an aircraft.

(3) The Authority shall have power to-

(a) free and unobstructed access to all civil aviation personnel, aircraft, aviation facilities, to inspect aircraft, aircraft manufacturers and maintenance facilities or organizations, training facilities (including simulators), and other appliances designed for use in air transportation, as may be necessary to enable the Authority to determine the issuance or granting of a certificate of registration or approval to such aircraft, aircraft manufacturer and maintenance facility or organization and other applicable appliances;

(b) issue, amend, vary, cancel, refuse and suspend approved maintenance organization certificates in conformity with regulations made under this Act;

(c) issue, amend, vary, cancel, refuse and suspend a production certificate;

(d) issue or validate type certificates and prescribe in such certificates, terms, conditions and limitations as are required in the interest of safety;

(e) issue, renew or validate certificates of air worthiness in respect of an aircraft, and specify in such certificates, the duration of such certificates, the type of services for which the aircraft may be used and such other terms, conditions or limitations as are required in the interest of safety;

(f) issue, amend, vary, cancel and suspend airworthiness approvals, licenses and certificates in conformity with regulations made under this Act;

(g) develop, issue and amend airworthiness directives, bulletins, orders, terms and conditions to bring them into conformity with airworthiness regulations;

(h) establish flight operations, airworthiness engineering and airworthiness inspection organizations, necessary for the requirements of safety of air navigation;

(i) establish a personnel licensing system to license aircraft maintenance personnel, flight crew, air traffic controllers, flight operations officers and such other persons engaged in the use or operation of aircraft, aircraft facilities, aerodromes and other activities related, incidental or supplementary thereto, in accordance with the provisions of this Act, regulations and the licensing requirements specified in Annex 1 of the Chicago Convention;

(j) specify, monitor and supervise the conditions under which an aircraft may carry passengers, mail and cargo or be used for other purposes, and prohibit an aircraft from the carriage of such classes of goods as the Authority may prescribe from time to time;

(k) certify/grant licenses in respect of aerodromes and certify airways, navigational approaches and landing aids in Nigeria to ensure safety of air navigation;

(l) prohibit and regulate the installation of any structure, which by virtue of its height or position is considered to endanger the safety of air navigation;

(m) institute and regulate the use of civil air ensign and other ensign established for purposes connected with air navigation in Nigeria;

(n) regulate the activities of air navigation service providers in accordance with ICAO Standards and Recommended Practices and national laws;

(o) regulate and participate in aeronautical search and rescue operations;

(p) determine the need for commercial air transport operations;

(q) regulate the standards for the provisions of air traffic services and prescribe air traffic regulations, rules or conditions on aircraft flights(including safe altitudes) for the purpose of navigating, protecting and identifying aircraft, protecting individuals and property on ground and preventing collision between aircraft and land or water vehicles and between an aircraft and airborne objects;

(r) regulate the standards for the provision of aeronautical meteorological services for the safe conduct of civil aviation operations;

(s) regulate the standards for the provision of civil aviation security in Nigeria.

(4) Notwithstanding the provisions of subsections (1) and (3) of this section, the Authority shall have and exercise the powers generally to

(a) regulate, supervise and monitor the activities of Nigerian and Foreign carriers, travel and other aviation agents operating in Nigeria, and to keep a register in respect thereof;

(b) require periodic statistical/financial and special returns and special reports from any air carrier, prescribe the manner and form in which such reports or returns shall be made, and require from any air carrier specific answers to questions upon which it deems information may be necessary;

(c) prescribe the form of financial records and memoranda to be kept by air carriers including accounts, records and memoranda of the movement of traffic and the receipt of and expenditure of money and length of time such accounts, records and memoranda may be preserved;

(d) require every Nigerian and Foreign carrier to the and keep open for public inspection, tariffs showing all rates, fares and charges charged by it, in such form and manner as may be prescribed by the Authority from time to time, and to approve or reject tariffs so filed which are inconsistent with approved rates specified by the Authority under the provisions of this Act, regulations, rules and orders made thereunder:

Provided that the rates, fares and charges shown in any tariff shall in the first instance be denominated in local currency, without prejudice to these being denominated in foreign currencies in the case of foreign carriers;

(e) require an air carrier to maintain reasonable and adequate rates of compensation and other conditions of service for its employees so as to bring them into conformity with prevailing labour practices in the industry;

(f) require a domestic air carrier to submit annually and at such other times as it may deem fit, a list showing the names of its shareholders or any person holding more than 5 per cent of the shares in the air carrier together with the names of any person on whose behalf such shares are held;

(g) require every Nigerian carrier to file with it a true copy of every contract or agreement affecting air transportation or any modification or cancellation thereof, between the air carrier and any other air carrier or other bodies, for leases, pooling or apportioning earnings, losses, traffic, service or equipment or relating to establishment of transportation fares, charges or classifications, or for preserving and improving safety, preventing or otherwise eliminating destructive, oppressive or wasteful competition or for any other cooperative working arrangement;

(h) disapprove of such contract or agreement described in paragraph (g) whether or not previously approved that is found to be adverse to the public interest or to be in violation of the provisions of this Act, regulations, rules and orders made by the Authority under this Act;

(i) investigate and determine upon its own initiative or upon receipt of a complaint by any air carrier, air travel agent, consumer of air transport service or other allied aviation service provider, whether any air carrier, air travel agent or provider of any other allied aviation service has been or is engaged in unfair or deceptive practices or unfair methods of competition in air transportation, the sale of tickets thereof or in the provision of other allied aviation service and order such air carrier, air travel agent or other allied aviation service provider to desist from such practices or methods of competition;

(j) establish procedures for investigation and determination of requests or applications for special operating authorisations; such procedures may include written notice to holders of air operator's certificates to make submissions which may be heard orally in support of such application as will not unduly delay the issuance of the special operating authorisation, taking into consideration the degree or emergency involved;

(k) participate in and advise the Minister on technical matters including Bilateral Air Services Agreements, and generally on activities of international aviation organizations;

(l) set training standards for and approve air transport training institutions;

(m) institute programmes for the protection of consumer interests;

(n) specify the fees to be paid for the issue, validation, renewal, extension or variation of any certificate, license or other document issued pursuant to this Act or the undergoing of any examination or test required which may be expedient for the purpose of the regulation of fees charged;

(o) prescribe the minimum insurance cover to be taken out by any air operator certificate holder, aerodrome operator or air traffic control service provider taking into account, as the basis for such minimum, the respective risk involved in such operations;

(p) ensure that the extent of insurance cover undertaken by any holder shall not be less than that prescribed by the Authority;

(q) fix and impose charges in respect of the grant of any license, permit, certificate or other authorisation to any person under this Act or regulations made pursuant thereto and in respect of the registration of aircrafts or mortgages in respect thereof, approvals, consents and any other form of benefit conferred on any person pursuant to this Act or the regulations made pursuant thereto;

(r) conduct economic regulation of airlines, aerodromes, air navigation services, other aviation and allied aviation service providers.

(5) The powers conferred upon the Authority under this section includes the powers to develop, make, issue and revise regulations, rules, orders, terms and conditions in respect of any matter relating, incidental, or supplemental thereto, or such matter as the Authority may deem necessary in the public interest and safety of air navigation.

(6) In the exercise of the powers conferred upon it and the discharge of its functions in this Act, the Authority, subject to the provisions of section 28 of this Act, shall not submit its decision for the approval of or be bound by the decisions or recommendations of any person, body or organization, but shall be guided by safety, security and public interest considerations.

(7) The powers conferred on and the functions of the Authority in this Act are vested on the Director-General of the Authority who may exercise them directly or through the Directors in charge of the under listed Directorates-

(a) Air Worthiness Standards;

(b) Air Transport Regulation;

(c) Operations and Training Standards;

(d) Aerodrome and Airspace Standards;

(e) Licensing Standards;

(f) Aeromedical Standards;

(g) Legal;

(h) Finance and Accounts;

(i) Administration and Corporate Affairs;

or other staff of the Authority.

(8) The Director-General shall establish the credentials of the Safety Inspectors of the Authority.

(9) The Director-General may delegate any assigned powers and duties to any properly qualified private person, subject to such regulation, supervision and review as may be prescribed by the Authority although the Director-General shall ensure that such functions are not delegated in such a way that aircraft operators, airport Civil Aviation Act operators, aerial work service providers, general aviation operators and maintenance facility operators, in effect, regulate themselves.

(10) Regulations made under this section shall provide for the imposition of Penalties for offences against the regulations, including the suspension or revocation of certificates, licenses and authorisations, and in the case of any particular offence such fine as may from time to time be prescribed by regulation 9 made by the Authority and or imprisonment for a term not less than six months, and, subject to Chapter IV of the Constitution of the Federal Republic of Nigeria (which relates to fundamental rights), for the taking of such steps (including the interception of aircraft) as may be prescribed as respects aircraft flying over areas of Nigeria over which flying is prohibited by the regulations.



(11) Regulations made under this section may make different provisions with respect to different classes of aircraft, aerodromes, persons or property and with respect to different circumstances but shall, so far as practicable, be so framed as not to discriminate in like circumstances.

(12) In the exercise of its power to make regulations under this section, the Authority shall consult with stakeholders including airlines, aerodrome operators, air traffic control service providers, consumers and other relevant bodies and organizations in the aviation industry.

## PART X

### *Functions of the Authority*

#### **31. Functions of the Authority**

The Authority shall be responsible for-

(a) the registration of any aircraft in Nigeria and issuance to the owner thereof, of a certificate of registration;

(b) the establishment and maintenance of a system or register for recording the title to or any interest in any aircraft registered in Nigeria;

(c) the prohibition of any Nigerian or foreign registered aircraft from operating within the Nigerian airspace, unless a certificate of airworthiness in respect thereof, is issued or validated under the regulations in force with respect to the aircraft:

Provided that the foregoing prohibition shall not apply to aircraft undergoing test flights or flights to places where prescribed maintenance or repairs are to be carried out;

(d) the inspection and regulation of aerodromes, inspection of aircraft factories and for the prohibition or regulation of the use of aerodromes which are not licensed in pursuance of the regulations;

(e) the prohibition of any person from engaging in air navigation in any capacity whatsoever unless the Authority determines that such a person satisfies the requirements of this Act and the regulations made there under;

(f) ensuring the efficiency and regularity of air navigation and the safety of aircraft, persons and property carried in aircraft and for preventing aircraft from endangering persons and property;

(g) the prohibition of aircrafts from flying over such areas in Nigeria as may be prescribed;

(h) the issue, validation, renewal, extension or variation of any certificate, license or other document required by the regulations (including the examinations tests to be undergone) and custody, and production, cancellation, suspension, endorsement and surrender of any such document;

(i) the registration of births and deaths occurring in aircraft and of particulars of persons missing from aircraft; and

(j) the collation and maintenance of a data bank of aviation and aircraft accidents, incidents, and occurrences and promote accident prevention programmes.

## PART XI

### *Control of Air Transport Undertaking*

#### **32. Licensing of air transport undertakings**

(1) Subject to the provisions of section 34 of this Act-

(a) no aircraft shall be used by any person in Nigeria for flying, while carrying passengers or cargo for reward, on such journeys or classes of journeys (whether beginning and ending at the same point or at different points) or for such flying undertaking for the purpose of any trade or business, except under the authority of and in accordance with a license, permit, or other authorization issued to him by the Authority.

(b) no aircraft shall be used by any person in Nigeria for any other purpose save for military, police, customs, or immigration operations, except under the authority of and in accordance with a license, permit, or other authorisation issued by the Authority.

(2) The Authority may by regulations prescribe the types of licenses, permits, certificates or other authorisation, which may be issued and the terms and conditions upon which they may be issued.

(3) Nothing in this section shall restrict the right of a designated air transport undertaking, having its principal place of business in any country outside Nigeria, to provide transport for passengers, mail or cargo-

(a) in accordance with the terms of any agreement for the time being in force between the government of the Federal Republic of Nigeria and the government of that country; or

(b) in accordance with the terms of any permission granted by the Minister pending the completion of the negotiations for such an agreement referred to in Paragraph (a).

(4) An application for the grant of a license, permit, certificate or other authorisation must be made in writing to the Authority and contain such particulars with respect to such matters as the Authority may specify in a notice published in the prescribed manner and where an application is made for the grant of any such license, permit, certificate or other authorization, the Authority shall subject to subsection (6) of this section, either grant such license, permit, certificate or other authorisation to the applicant in the terms requested in the application, or in those terms with such modifications as the Authority thinks fit, or refuse to grant such license, permit, certificate or other authorisation.

(5) Where an application is made to the Authority and the Authority is satisfied that the applicant has met and complied with all the requirements necessary for grant of a license, permit, certificate or other authorisation, the Authority shall give notice of such compliance by the applicant.

(6) Upon receipt of the notice aforesaid, the Authority may approve or disapprove the grant of such license, permit, certificate or other authorisation and the Authority shall proceed to grant the said license, permit, certificate or other authorisation;

Provided that, the Authority shall not approve any applicant for the grant of a licence, permit, certificate or other authorisation in respect of whom the Authority has given notice that such an applicant has met and complied with all the requirements for the grant of such license, permit, certificate or other authorisation.

### **33. Eligibility for licenses, permits, etc.**

(1) Notwithstanding the provisions of section 17 of the Nigeria Investment Promotion Commission Act, the Authority shall refuse to grant a license permit, certificate or other authorisation in pursuance of an application if it is not satisfied that-

[1995 No. 16]

(a) the applicant is-

- (i) a citizen of Nigeria, or
- (ii) being a company or a body corporate, is registered in Nigeria and has its principal place of business within Nigeria, and is controlled by Nigeria nationals;

(b) the applicant is, having regard to-

- (i) his and his employees' experience in the field of aviation and his and the past activities generally, and
- (ii) where the applicant is a body corporate, the experience in the field of aviation and the past activities generally of the persons appearing to the Authority to control that body, a fit person to operate aircrafts under the authority of the license, permit, certificate or other authorisation which the Authority considers should be granted to him in pursuance of the application; or

(c) the resources of the applicant and the financial arrangements made by him are adequate for discharging his actual and potential obligations in respect of the business activities in which he is engaged if any, and in which he may be expected to engage if he is granted the license, permit, certificate or other authorisation which the Authority considers should be granted to him in pursuance of the application.

(2) The provisions of subsection (1) of this section shall not apply to any license, permit, certificate or other authorisation needed by a person for the purpose of operating an aircraft for private use only.

### **34. Air Operator Certificate (A.O.C.) and other safety certificates**

(1) The Authority shall issue Air Operators Certificates and all other certificates relating to the safety of air transport undertakings.

(2) The Authority shall by regulation prescribe the minimum safety standards and all other relevant requirements for the grant, issuance, operation, variation, and renewal of such certificates.

(3) The Authority shall by regulation, issue operation specifications that define the approved terms, conditions and limitations of such operations.

(4) The Authority shall by regulation prescribe conditions for the revocation, suspension or other limitation of Air Operator Certificates.

### **35. Variation, suspension and revocation of licenses, permits, etc.**

(1) An application for the variation, suspension or revocation of a licence, permit, certificate or other authorisation may be made to the Authority at any time in such manner and by such person(s) as may be prescribed in writing by the Authority.

(2) The Authority may at any time vary, suspend or revoke, a licence, permit, certificate or other authorisation if it considers it appropriate to do so, whether or not such an application with respect to the license, permit, certificate or authorisation has been made pursuant to subsection (1) of this section.

(3) The Authority may exercise its powers under subsection (2) hereof to revoke, suspend or vary a license, permit, certificate or authorisation (whichever is appropriate in the circumstances) if it is not or is no longer satisfied that-

(a) the holder of the license is, having regard to-

- (i) his and his employees' experience in the field of aviation and his and their past activities generally, and
- (ii) where the holder of the license is a body corporate, the experience in the field of aviation and the past activities generally of the persons appearing to the Authority to control that body,

a fit person to operate air transport business under the authority of the license, permit, certificate or other authorisation; or

(b) the resources of the holder of the license, permit, certificate or other authorisation and the financial arrangements made by him are adequate for discharging his actual and potential obligations in respect of the business activities in which he is engaged;

(c) the holder of a license, permit, certificate or other authorisation subject to section 34(2) is a citizen, of Nigeria or such a company or body as mentioned in paragraph (a)(ii) of sub-section (1) of section 33;

(4) The Authority may exercise its powers under subsection (2) hereof to revoke, suspend or vary a license, permit, certificate or authorisation (whichever is appropriate in the circumstances) if it is not or

is no longer satisfied that the holder of a license has not contravened any of the provisions of this Act or any regulation made there under especially provisions and regulations relating to safety and security or any provision or regulation the breach of which constitutes an offence under this Act or such regulation.

(5) The provisions of subsections (2) and (3) conferring on the Authority power to revoke, suspend or vary a license, permit, certificate or other authorisation shall be construed as conferring on the Authority power to provide, by a notice in writing served in the prescribed manner on the holder of the license, permit, certificate or other authorisation that the license, permit, certificate or other authorisation shall not be effective during a period specified in the notice.

(6) The Authority may, while a license, permit, certificate or other authorisation is ineffective by virtue of such a notice, by a further notice in writing served in the prescribed manner on the holder, provide that the license, permit, certificate or other authorisation shall be effective on and after a date specified in the further notice but the further notice shall not prejudice the Authority's powers to suspend the license, permit, certificate or other authorisation again or to revoke or vary it.

### **36. Supplementary provisions relating to licensing, permits, etc.**

(1) Where the Authority takes a decision refusing to grant, vary, suspend or revoke a license, permit, certificate or other authorisation, the Authority shall subject to subsection (2) below, furnish a statement of the reasons for the decision to the applicant for the license, permit, certificate or other authorization, or as the case may be, to the holder and to any other person who in accordance with rules made pursuant to this Act has filed an objection in the case or requested such a statement, provided that, no statement of reasons need be furnished in pursuance of this subsection in a case in which the decision is taken in pursuance of a request by the holder of a license, permit, certificate or other authorisation for the variation, suspension or revocation of it.

(2) The Authority may refrain from furnishing a statement of reasons in pursuance of sub-section (1) of this section, if it has reason to believe that it might adversely affect the security interests of Nigeria or the relations of Nigeria with any other country.

(3) The Authority may publish in such manner as it thinks fit particulars of, and of its reasons for, any decision taken with respect to a license, permit, certificate or other authorisation or an application for such a license, permit, certificate or other authorisation.

(4) A person who, for the purpose of obtaining for himself or another person a license, permit, certificate or other authorisation or with regard to a variation or the cancellation or suspension of a license, permit, certificate or other authorisation knowingly or recklessly furnishes to the Authority any information which is false, commits an offence and liable on conviction to imprisonment for a term of not less than 6 months or a fine of not less than ₦500,000.00 (Five Hundred Thousand Naira) or both.

### **37. General duties in relation to licensing function of the authority**

(1) The Authority shall perform its air transport licensing functions in the manner which it considers best to ensure that Nigerian registered airlines compete as effectively as possible with other airlines in

providing air transport services on international routes: and in performing those functions the Authority shall also have regard to-

(a) any advice received from the Minister with respect to the likely outcome of negotiations with the government of any other country or territory for the purpose of securing any right required for the operation by an airline in Nigeria of any air transport services outside Nigeria; and

(b) the need to secure the most effective use of aerodromes within Nigeria.

(2) In considering whether to grant a license, permit, certificate or other authorisation, the Authority shall have regard to the effect on existing air transport services provided by Nigerian registered airlines, of authorising any new services the applicant proposes to provide under the license, permit, certificate or other authorisation.

(3) Where two or more applicants have applied for the same license, permit, certificate or other authorisation under which each proposes to provide similar services, the Authority shall have regard in particular to any benefits which may arise from enabling two or more airlines to provide the services in question.

## PART XII

### *Provision of Aerodromes, Control of Land for Aviation Purposes etc.*

#### **38. Power of minister to approve the establishment aerodromes**

(1) The Minister may approve the establishment and development of aerodromes anywhere in Nigeria.

(2) Roads, approaches, apparatus, equipment, buildings and other accommodations in connection to such aerodromes shall be maintained by the owners in conformity with rules and regulations made under this Act.

#### **39. Eligibility for an aerodrome license**

A license for an aerodrome shall not be granted to any person other than-

(a) a citizen of Nigeria; or

(b) the Federal Government, a State Government, a Local Government or any company or corporation owned or controlled by either of the said Governments; or

(c) a company or a corporation registered in Nigeria and having its principal place of business in Nigeria.

#### **40. Duty of the authority to consider environmental factors when licensing aerodromes**

The Authority in exercising its functions in relation to the licensing of aerodromes shall have regard to the need to minimize so far as practicable any adverse effect the presence of such aerodromes may have on the environment.

#### **41. Fixing by reference to noise factors, the charges for using licensed aerodromes**

Without prejudice to any power of an aerodrome operator to enter into an agreement on such terms as he or it thinks fit, an aerodrome operator may for the purpose of encouraging the use of quieter aircraft and of diminishing inconvenience from aircraft noise, fix his or its charges by reference, among other things, to any fact or matter relating to -

- (a) the amount of noise, vibration or emission caused by the aircraft in respect of which the charges are made; or
- (b) the extent or nature of any inconvenience resulting from such noise, vibration or emission.

#### **42. Requirements for approval of aerodrome security programme**

- (1) No aerodrome operator shall permit his or its aerodrome to be used for operation of air transport service unless he or it has the airport security programme approved by the Authority.
- (2) The aerodrome operator, his or its representatives and servants to comply with the provisions of the approved security programme.
- (3) Every breach of the provisions of the approved airport security programme shall attract a fine of not less than ₦200,000.00 (two hundred thousand naira),

#### **43. Requirements for approval of airline security programme**

- (1) No airline operator shall operate air transport service to, from and within Nigeria unless he has a security programme approved by the Authority.
- (2) The airline operator, its representatives and servants shall comply with the provisions of the approved security programme.
- (3) It shall be the duty of the airline operator, its representatives and servants to comply with the provisions of the approved security programme.
- (4) Every breach of the provisions of the approved airline security programme shall attract a fine of not less than ₦200,000.00 (two hundred thousand naira).

#### **44. Security surveys, audits, test and inspections**

The Authority or any other person authorised by it by general or special order in writing in this behalf may -

- (a) conduct surveys and inspections of security measures relating to passengers and their cabin baggage, checked baggage, cargo and other goods, access controls and aerodrome design;

(b) conduct an exercise to check the professional efficiency of those personnel responsible for implementing the aviation security procedures and also to test the adequacy of security measures at any aerodrome in Nigeria.

#### **45. Security checks of persons and baggage**

(1) Every person entering an aerodrome and every person before proceeding for boarding an aircraft and his hand baggage, if any, shall be liable to be searched and shall permit to be searched by an aviation security officer or any other person authorized in that behalf in writing by the Minister.

(2) Baggage of every person boarding an aircraft and all unaccompanied baggage shall be screened or subjected to prescribed security control before they are placed on board or carried on an aircraft.

(3) Baggage of every person boarding an aircraft and all unaccompanied baggage shall be screened or subjected to prescribed security control before they are placed on board or carried on an aircraft.

(4) Every breach of the provisions of this Section shall attract a fine of not less than ₦50,000.00 (fifty thousand naira).

#### **46. Obstructions near aerodromes**

(1) If the Authority is satisfied, with respect to any building or structure in the vicinity of an aerodrome to which this section applies, that in order to avoid danger to aircraft flying in that vicinity in darkness or conditions of poor visibility, provision ought to be made (whether by lighting or otherwise) for giving to such aircraft warning of the presence of that building or structure, it may by order direct (subject to any conditions specified in the order) the operator of the aerodrome and any person acting under the operator's instructions

(a) to execute, install, maintain, operate, and as occasion requires repair and alter, such works and apparatus as may be necessary for enabling such warning to be given in the manner specified in the order, and

(b) so far as may be necessary for exercising of the powers conferred by the order, enter upon and pass over (with or without vehicles) any such land as may be specified in the order:

Provided that, no such order shall be made in relation to any building or structure if it appears to the Authority that there have been made, and are being carried out, satisfactory arrangements for the giving of such warning.

(2) The Authority shall, before making any such order cause to be published, in such manner as it thinks best for informing persons concerned, notice of the proposal to make the order and of the place where copies of the draft order may be obtained free of charge, and take into consideration any representations with respect to the order which may within such period not being less than 14 (Fourteen) days after the publication of the notice as may be specified therein, be made to it by any person appearing to it to have an interest in any land which would be affected by the order, and at the



end of that period the order may subject to the provisions of this section, be made with such modifications (if any) of the original draft as the Authority thinks proper.

(3) Every such order shall provide that-

(a) except in a case of emergency, no works shall be executed on any land in pursuance of the order unless, at least 14 (fourteen) days previously, the operator of the aerodrome to which the order relates has served in the manner specified by the order on the occupier of that land, and on every other person known by the operator to have an interest in the land, a written notice containing such particulars of the nature of the proposed works, and the manner in which and the time at which it is proposed to execute them, as may be specified by the order;

(b) if within 14 (fourteen) days from the service of the said notice on any person having such an interest, the operator of the aerodrome receives written objection on the part of that person to the proposals contained in the notice, then, except in so far as the objection is withdrawn, no steps shall be taken in pursuance of the notice without the specific authority of the Authority; and

(c) the operator of the aerodrome to which the order relates to pay to any person having an interest in any land affected by the order adequate compensation for any loss or damage which that person may suffer in consequence of the order; and for the purposes of this subsection any expense reasonably incurred in connection with the lawful removal of any apparatus installed in pursuance of such an order, and so much of any expense incurred in connection with the repair, alteration, demolition or removal of any building, structure or erection to which such an order relates as is attributable to the operation of the order, shall be deemed to be loss or damage suffered in consequence of the order.

(4) The ownership of anything shall not be taken to be affected by reason on that it is placed in, or affixed to, any land in pursuance of such an order; and (subject to the provisions of the next following subsection) so long as any such order respect of an aerodrome is in force, no person shall, except with the consent of the operator of the aerodrome, willfully interfere with any works or things which, to the knowledge of that person, are works or things executed or placed in on or over any land in pursuance of the order.

(5) Any person who contravenes the provision of subsection (4) of this section, commits an offence and is liable on conviction to imprisonment for a term not less than 6 months or a fine not less than ₦100,000.00 or both; and any person who willfully obstructs a person in the exercise of any of the powers conferred by such an order commits an offence and is liable on conviction to imprisonment for a term not less than 6 months or a fine not less than ₦100,000.00 or both.

(6) Nothing in this section shall operate, in relation to any building or structure, so as to restrict the doing of any work for the purpose of repairing, altering demolishing or removing the building or structure if-

(a) notice of the doing of the work is given as soon as may be to the operator of the aerodrome; and

(b) the giving of warning of the presence of the building or structure in the manner provided by, any order under this section in force in relation thereto is not interrupted.

(7) in this section-

(a) the expression “**aerodrome to which this section applies**” means

- (i) an aerodrome under the control of the Minister or of the Minister of the government of the Federation responsible for defence, or
- (ii) any premises which, in pursuance of regulations made under section 30 of this Act are for the time being licensed as an aerodrome, and

(b) the expression “**operator of the aerodrome**” means-

- (i) in the case of such an aerodrome as is mentioned in sub-paragraph (i) of paragraph (a) of this subsection, the person in charge of the aerodrome, and
- (ii) in any other case, the holder of the license issued in respect of the aerodrome in pursuance of this Act.

#### **47. Trespass on Licensed Aerodromes etc**

(1) Subject to subsection (2) of this section, any person who trespasses on any land forming part of an aerodrome, or upon which navigational aids or any ancillary facility is situated commits an offence and is liable on conviction, to imprisonment for a term not less than 1 month or a fine of not less than ₦100,000.00 or both.

(2) No person shall be liable under this section. unless it is proved that at the material time, notices warning trespassers of their liability under this section were posted, so as to be readily seen and read by members of the public, in such position on or near the boundary of the aerodrome or land upon which any navigational aid or ancillary facility is situated as appear to the court to be proper.

### PART XIII

#### *Special Provisions as to Trespass, Nuisance, Salvage and Patents, etc.*

#### **48. Carriers' Liability**

(1) The provisions contained in the Convention for the Unification of certain rules relating to International Carriage by Air signed at Montreal on 28th May, 1999 set out in the Second Schedule of this Act and as Amended from time to tune, shall from the commencement of this Act have force of law and apply to international carriage by air to and from Nigeria, in relation to any carriage by air to which those rules apply irrespective of the nationality of the aircraft performing the carriage, and shall, subject to the provisions of this Act, govern the rights and liabilities of carriers, passengers, consignors, consignees and other persons.

[Second Schedule]

(2) The provisions contained in the Convention for the Unification of Certain Rules Relating to international Carriage by Air signed at Montreal on 28th May, 1999. as has been modified and Set out in the Third Schedule of this Act and as amended from time to time, shall from commencement of this Act have force of law and apply to non-international carriage by air within Nigeria, irrespective of the nationality of the aircraft performing the carriage and shall subject In the provisions of this Act, govern the rights and liabilities of carriers, passengers, consignors, consignees and other persons.

[Third Schedule]

(3) In any case of aircraft accident resulting in death or injury of passengers the carrier shall make advance payments of at least US \$30,000.00 (thirty thousand United States Dollars) within 30 (thirty) days from the date of such accident to the natural person or such natural persons who are entitled to claim compensation in order to meet the immediate economic needs of such persons and such advance payments shall not constitute recognition of liability and may be offset against any amounts subsequently paid as damages by the carrier.

**49. Action in trespass, nuisance and damage from Aircraft**

(1) No action shall lie in respect of trespass or nuisance by reason only of the flight of an aircraft over any property at a height above the ground which, having regard to wind, weather and all the circumstances of the case as reasonable, or the ordinary incidents of such flight, so long as the flight over such property duly complies with any regulations in force made in respect thereto.

(2) Where injury, loss or damage is caused to any person or property on land or water by an article or a person in or falling from an aircraft while in flight, taking off or landing, then, without prejudice to the law relating to contributory negligence damages in respect of the injury, loss or damage shall be recoverable without proof of negligence or intention or any other cause of action, as if the injury, loss or damage had been caused by the willful act, neglect or default of the owner of the aircraft:

Provided that where the injury, loss or damage is caused in circumstances in which-

(a) damages are recoverable from the owner in respect of the injury, loss or damage by virtue only of the foregoing provisions of this subsection; and

(b) a legal liability exists in some person other than the owner to pay damages in respect of the injury, loss or damage,

the owner shall be entitled to be indemnified by that other person against any claim in respect of the said injury, loss or damage.

(3) Where any aircraft has been *bona fide* demised, let or hired not to any person by the owner thereof and no pilot, commander, navigator or operative member of the crew of the aircraft is in the

employment of the owner, this section shall have effect as though references to the owner here were substituted for references to the person to whom the aircraft has been so demised, let or hired out.

#### **50. Application to Aircraft of law of wreck and salvage**

(1) Any services rendered in assisting, or in saving life from, or in saving the cargo or apparel of, an aircraft in, on or over the sea or any tidal water, or on or over the shores of the sea or any tidal water, shall be deemed to be salvage services in all cases in which they would have been salvage service if they had been rendered in relation to a vessel.

(2) Where salvage services are rendered by an aircraft to any property or person, the owner of the aircraft shall be entitled to the same reward for those services as he would have been entitled to if the aircraft had been a vessel.

(3) The provisions of subsections (1) and (2) of this section shall have effect, notwithstanding that the aircraft concerned is a foreign aircraft and that the services in question are rendered elsewhere than within the limit of the territorial waters of Nigeria.

(4) The Minister may by regulations direct that any provisions of any law for the time being in force in Nigeria which relate to wreck, to salvage of life or property or to the duty of rendering assistance to vessels in distress shall, with such modifications and exceptions (if any) as may be prescribed, apply in relation to aircraft as those provisions apply in relation to vessels.

(5) For the purposes of this section, any provisions of any law in force in Nigeria, which relate to vessels laid by, or neglected as unfit for sea service shall be deemed to be provisions relating to wreck.

#### **51. Patent claims**

(1) Any lawful entry into Nigeria or any lawful transit across Nigeria, with or without landings, of an aircraft to which this sub-section applies, shall not, entail any seizure or detention of the aircraft or any proceedings against the owner or operator of the aircraft or any other interference with the aircraft by or on behalf of any person in Nigeria on the ground that the construction, mechanism, parts, accessories, or operation of the aircraft is an infringement of any patent, design or model.

(2) The importation into and storage in Nigeria of spare parts and spare equipment for an aircraft to which this sub-section applies and the use and installation thereof in the repair of such an aircraft, shall not, entail any seizure or detention of the aircraft or of the spare parts or spare equipment or any proceedings against the owner or operator of the aircraft or the owner of the spare parts or spare equipment or any other interference with the aircraft by or on behalf of any person in Nigeria, on the ground that the spare parts or spare equipment or their installation are or is an infringement of any patent, design or model:

Provided that, this subsection shall not apply in relation to any spare parts or spare equipment which are sold or distributed in Nigeria or are exported from Nigeria for sale or distribution.

(3) Subsections (1) and (2) of this section applies to-

(a) any aircraft (other than an aircraft used in military, customs or police services) registered in a country or territory in the case of which there is for the time being in force a declaration made by the Minister with, a view to the fulfilment of the relevant provisions of the Convention mentioned in section 30 (1)

(a) of this Act, that the benefits of those subsections extend to that country or territory; and

(b) such other aircraft as the Minister may by order specify.

## **52. Infringement of patent**

(1) Where it is alleged by any interested person that a foreign aircraft which is not an aircraft to which section 51 (1) of this Act applies and which is making a passage through or over Nigeria, infringes in itself or part of it any invention, design or model which is entitled to protection in Nigeria, subject to and in accordance with any order made by the Minister, it shall be detained until the owner of it deposits or secures in respect of the alleged infringement a sum (hereafter in this section referred to as “the deposited sum”); and thereupon the aircraft shall not, during the continuance of the passage, be subject to any lien, arrest, detention or prohibition, whether by order of a court or otherwise, on account of the alleged infringement.

(2) The deposited sum shall be such sum as may be agreed between the parties interested or, in default of agreement, as may be fixed by the Minister; and the payment of the deposited sum shall be made or secured to the Minister in such manner as may be specified by orders made by the Minister.

(3) The deposited sum shall be dealt with by such tribunal and in accordance with such procedure as may be prescribed by orders made by the Minister, and the orders may provide generally for carrying the provisions of subsections (1) and (2) of this section into effect.

(4) For the purposes of subsection (1) of this section, the expression “**owner**” shall include the actual owner of an aircraft and any person claiming through or under him, and the expression “**passage**” shall include all reasonable landings and stoppages in the course of the passage.

## **53. Detention of aircraft**

Any regulation, rule or order made under or in pursuance of this Act in relation to aircraft may, provide for the detention of aircraft to secure compliance with the regulation, rule or order and may make such further provisions as appear necessary or expedient for securing the detention.

## PART XIV

### *Offences*

## **54. Offences**

(1) Any act done by any person on a Nigerian aircraft outside Nigeria which, if it had been done by him in any part of Nigeria would have constituted an offence under the law in force in that part shall, for the

purposes of any criminal proceedings in that part of Nigeria against that person in respect of that act, be deemed to have been done by him in that part of Nigeria.

(2) Except with the consent of the Attorney-General of the Federation, no proceedings shall be instituted by virtue of the foregoing subsection against any person.

(3) Where it is alleged that an offence under this Act or regulations made by virtue of this Act has been committed, proceedings in respect of the offence may be brought in any court in Nigeria, which would have had jurisdiction in the matter if that offence had been committed in the part of Nigeria for which the Court acts.

### **55. Dangerous flying**

(1) Where an aircraft is flown in such a manner as to cause danger to any person or property in the aircraft, on land or water, the pilot or any other person in charge of the aircraft and the owner or any person having responsibility for safe navigation of the aircraft commits an offence and is liable on conviction to imprisonment for a term of not less than 2 years or a fine of not less than ₦1,000,000.00 (one million naira) or both.

(2) In any proceedings against the owner of an aircraft in respect of an alleged offence under this section, it is a defence to prove that the act alleged to constitute the offence was done without the fault, privity and consent of the owner.

(3) In this section, “**owner**”, is in relation to an aircraft and an alleged offence, includes any person by whom the aircraft is hired at the time of the alleged offence.

### **56. Hijacking and Interference**

(1) The provisions contained in the Convention for the Suppression of the Unlawful Seizure of Aircrafts signed at the Hague on the 16th day of December 1970 set out in the First Schedule to this Act and as amended from time to time shall from the commencement of this Act have force of law in Nigeria.

[First Schedule]

(2) Whosoever on board an aircraft either on ground or in flight unlawfully, by force or threat of force, or by any other form of intimidation, seizes or exercises control of that aircraft, commits offence of hijacking of such aircraft.

(3) Any person who attempts to commit any of the acts referred to in sub-section (2) of this section in relation to any aircraft, or is an accomplice to the commission of any such act, shall also be deemed to have committed the offence of hijacking of such aircraft.

(4) Any person who commits the offence of hijacking is liable on conviction to imprisonment for life and also to a fine of not less than ₦10,000,000.00 (ten million naira).

(5) Any person who in the course of committing the offence of hijacking of an aircraft, commits, in connection with such offence, any act of violence against any passenger or member of the crew of such aircraft, is liable to the same punishment with which he would have been liable under any law for the time being in force in Nigeria if such act had been committed in Nigeria.

(6) The Courts of the Federal Republic of Nigeria shall have jurisdiction to try offenders under this section where-

(a) the offence is committed on board an aircraft registered in Nigeria;

(b) the aircraft on board which the offence is committed lands in Nigeria with the alleged offender still on board;

(c) the offence is committed on board an aircraft leased without crew to a lessee who has his principal place of business in Nigeria or if he has no principal place of business, his permanent residence is in Nigeria; and

(d) the offence is committed on board a non-Nigerian registered Aircraft whilst such an aircraft is within the territory of the Federal Republic of Nigeria.

#### **57. Offences of endangering safety, destroying or damaging of an Aircraft in flight, etc.**

(1) Any person who unlawfully and intentionally

(a) commits an act of violence against a person on board an aircraft in flight which is likely to endanger the safety of such aircraft; or

(b) communicates such information which he knows to be false so as to endanger the safety of an aircraft in flight,

commits an offence and shall be liable on conviction to imprisonment for 5 years or a fine of not less than ₦2,000,000.00 (two million naira).

(2) Any person who unlawfully and intentionally-

(a) destroys an aircraft in service or causes damage to such aircraft in such a manner as to render it incapable of flight or which is likely to endanger its safety in flight; or

(b) places or causes to be placed on an aircraft in service by any means whatsoever a device or substance which is likely to destroy that aircraft or to cause damage to it which renders it incapable of flight or to cause damage to it which is likely to endanger its safety in flight,

commits an offence and is liable on conviction to a maximum of life imprisonment and his assets may be confiscated or to both.

(3) Whoever attempts to commit or abets the commission of any offence under subsection (1) or (2) of this section shall also be deemed to have committed such offence and be liable on conviction to the punishment for such offence.

#### **58. Prohibition of unruly and indecent conduct**

The Authority may by regulations prohibit certain acts which constitute unruly or indecent behaviour on board aircraft in or over Nigeria and such regulations may include appropriate criminal sanctions.

#### **59. Offences at aerodromes**

(1) Any person who, at any aerodrome, unlawfully and intentionally, uses any device, substance or weapon to-

(a) commit an act of violence which causes or is likely to cause grievous hurt of any person, or

(b) destroy or seriously damage any aircraft or facility at an aerodrome or disrupt any service at the aerodrome,

commits an offence and is liable on conviction to imprisonment for life or to a fine of not less than ₦10,000,000.00 (ten million naira).

(2) Any person who attempts to commit, or abets the commission of any offence under subsection (1) of this section is also deemed to have committed such offence and is liable on conviction to the punishment provided for such offence.

#### **60. Destruction of, or damage to, air navigation and other facilities**

(1) Any person who unlawfully and intentionally destroys or damages air navigation and meteorological facilities or interferes with their operation in such a manner as is likely to endanger the safety of aircraft in flight commits an offence and is liable on conviction to imprisonment for a term of not less than 1 (one) year or to a fine of not less than ₦500,000 (five hundred thousand naira) or both.

(2) Any person who attempts to commit, or abets the commission of any offence under subsection (1) of this section is also deemed to have committed such offence and is liable to the punishment provided for that offence.

#### **61. Duties of operator and personnel, etc.**

(1) Each operator shall make or cause to be made, such inspection, maintenance, overhaul, and/or repair of all equipment used in civil aviation and to ensure that the operations conducted are in accordance with this Act and the regulations, by-laws, directives and orders of the Director-General issued by this Act.

(2) Each holder of an air operator certificate shall ensure that the maintenance of aircraft and operations of that air operator are conducted in the public interest and in accordance with the



requirements of this Act and the regulations, by-laws, directives and orders issued under this Act by the Director-General.

(3) Each holder of an airman certificate shall observe and comply with the authority and limitations of that certificate, the requirement of this Act and the regulations, by-laws, directives and orders issued under this Act.

(4) Every person performing duties in civil aviation shall observe and comply with the requirements of this Act and the orders, rules, regulations and by-laws issued under this Act relating to their tasks.

(5) Every person who offers, or accepts shipment of cargo, or baggage for civil air transport, whether originating or arriving in international flights to or from Nigeria, or for flights within Nigeria, shall offer or accept such shipment of cargo, or baggage in accordance with the provisions of Annex 18 to the Chicago Convention and the ICAO Technical Instructions for the Safe Transport of Dangerous Goods by Air or any regulations on Dangerous Goods made pursuant to this Act.

## **62. Transportation of dangerous goods by air**

The Authority shall monitor and enforce compliance with the provisions of Annex 18 to the Chicago Convention and the ICAO Technical Instructions for the Safe Transport of Dangerous Goods by Air, and is authorised to submit variations to the Technical Instructions on behalf of Nigeria where necessary.

## **63. Federal High Court to try offences**

(1) The Federal High Court shall have jurisdiction to try offences committed under this Act, and to hear all other matters involving the Authority and its obligations under any law.

(2) Without prejudice to the power of the Attorney-General of the Federation in section 174 of the Constitution of the Federal Republic of Nigeria, 1999, the Authority shall with the consent of the Attorney-General of the Federation have power to initiate and undertake the prosecution, in its name, of any person in respect of any offence created under the provisions of this Act, or any regulation, rule or order made pursuant to this Act.

## **PART XV**

### *General*

## **64. Power of the Authority to make rules for protecting public health**

(1) The Authority in consultation with either relevant government agencies may make regulations for the prevention of danger arising to public health by the introduction or spread of any infectious or contagious disease from aircraft arriving at or being at any aerodrome and for the prevention of the conveyance of infection or contagion by means of any aircraft leaving an aerodrome.

(2) The Authority may, by regulation provide that a breach of any regulation made pursuant to subsection (1) of this section shall be punishable with imprisonment for a period not less than 1 month or a fine of not less ₦100,000.00 or both.

#### **65. Emergency power for protecting public health**

(1) If the Minister is satisfied that Nigeria or any part thereof is visited by or threatened with an outbreak of any dangerous epidemic disease, and that the ordinary provisions of the law for the time being in force are insufficient for the prevention of danger arising to public health through the introduction or spread of the disease by the agency of the aircraft, the Minister may take such measures as deemed necessary to prevent such danger.

(2) In any such case the Minister may, without prejudice to the powers conferred by section 64 of this Act, by notification in the Official *Gazette* make such temporary orders with respect to aircraft and persons travelling or things carried therein and aerodromes as he deems necessary in the circumstances.

(3) Orders made under sub-section (2) shall not remain in force for more than three months from the date of notification, provided that the Minister may, by special order continue them in force for a further period or periods of not more than three months.

(4) In making any order under this section, the Minister may direct that a breach of it shall be punishable with imprisonment for a period not less than one year, or a fine not less than ₦500,000.00 or both.

#### **66. Power of Minister to make orders in emergency**

(1) In time of war, whether actual or imminent or when a proclamation of emergency under the Constitution is in force in the Federal Republic of Nigeria or any part thereof, if the Minister is of the opinion that in the interest of public safety or tranquility, the issue of all or any of the following orders is expedient, he may by notification in the Official *Gazette*-

(a) cancel or suspend, either absolutely or subject to such conditions as he may think fit to specify in the order, all or any licences, permits, certificates or other authorizations issued under this Act;

(b) prohibit either absolutely or subject to such conditions as he may think fit to specify in the order, or regulate in such manner as may be contained in the order, the flight of all or any aircraft or class of aircraft over the whole or any portion of Nigeria;

(c) prohibit, either absolutely or conditionally or regulate the erection, maintenance or use of any aerodrome, aircraft factory, flying-school or club, or place when aircraft are manufactured, repaired or kept, or any class or description thereof;

(d) direct that any aircraft or class of aircraft, or any aerodrome, aircraft factory, flying-school or club, or place where aircraft are manufactured, repaired or kept together with any machinery, plant, material or things used for the operation, manufacture, repair or maintenance of aircraft shall be delivered, either

further with or within a specified time, to such authority and in such manner as he may specify in the order, to be at the disposal of the Federal Government of Nigeria for the public service; or

(e) direct that any airline operator having its principal place of business in Nigeria, or an aerodrome operator or a provider of air traffic and meteorological services, and the employees of such airline operator, aerodrome operator or provider of air traffic and meteorological services, shall carry out flights, and other duties connected with operation of flights, in the public interest in the manner specified in the order.

(2) Any order made under subsection (1) of this section shall have effect, notwithstanding anything inconsistent therewith contained in any regulation made under this Act or any other statute in force in Nigeria.

(3) Any person who suffers direct injury or loss by reason of any order made under paragraph (c), (d) or (e) of subsection (1) of this section shall be paid such compensation as may be determined by such authority or person as the Minister may appoint in this behalf.

(4) The Minister may, authorize such steps to be taken to secure compliance with any order made under subsection (1) as appear to him to be necessary.

(5) Any person who knowingly disobeys, or fails to comply with, or does any act in contravention of an order made under subsection (1) of this section, commits an offence and is liable on conviction to imprisonment for a term not less than 6 months, or a fine not less than ₦100,000.00 (one hundred thousand naira), or both, and the court by which he is convicted may direct that the aircraft or thing, if any, in respect of which the offence has been committed, or any part of such aircraft or thing, shall be forfeited to the Federal Government.

## **67. Designation of essential Service**

(1) All services which facilitate and maintain the smooth, orderly and safe take off, flight and handling of aircrafts and handling of aircrafts and the disembarkation and evacuation of passengers and cargo respectively in all aerodromes in Nigeria are hereby designated as essential services pursuant to the provisions of section 11 (1) of the Constitution of the Federal Republic of Nigeria.

(2) The Minister may by regulations prohibit all or such class or classes of workers, officers and other employees or persons whether corporate or natural, engaged in the provision of the services specified in subsection (1) of this section from taking part in a strike or other industrial action.

(3) In this section, “**strike**” means the cessation of work by a body of persons employed, acting in combination or a concerted refusal or a refusal under a common understanding of persons employed to continue to work for an employer in consequence of a dispute, done as a means of compelling their employer, or the Government of the Federation of Nigeria or any part thereof, or to aid other workers in compelling their employer or any persons or body of persons employed, to accept or not to accept terms of employment and physical conditions of work or any Government economic policy or pricing of any essential product, and in this definition -

(a) **“cessation of work”** includes working at less than usual speed or with less than usual efficiency without reasonable operational justification; and

(b) **“refusal to continue to work”** includes a refusal to work at usual speed or with usual efficiency.

#### **68. Bilateral Exchanges of Safety oversight responsibilities**

(1) The Authority may pursuant to Article 83*bis* of the Convention on International Civil Aviation and by a Bilateral Agreement with the Aeronautical Authorities of another country exchange with that country all or part of their respective functions and duties with respect to registered aircrafts under the following articles of the conventions: Article 12 (Rules of the air), Article 31 (Certificates of airworthiness), or Article 32 (a) (Licenses of Personnel).

(2) The Authority relinquishes responsibility with respect to the functions and duties transferred by the Authority as specified in the Bilateral Agreement under the articles listed in subsection (6) for Nigerian registered aircraft described in subsection (6) (a) transferred abroad and accept responsibility with respect to the functions and duties under those articles for aircraft registered abroad described in subsection (6) (b) that are transferred to Nigeria.

(3) The Authority may predicate, in the Agreement, the transfer of functions and duties under this subsection on any conditions the Authority deems necessary and prudent, except that the Authority may not transfer responsibilities for Nigerian registered aircraft described in subsection (6) (a) to a country that the Authority determines is not in compliance with its obligations under International Law for the safety oversight of civil aviation.

(4) The Authority, pursuant to agreements entered into under this section, may recognize certificates of airworthiness and personnel licenses issued or renewed by the State of the operator.

(5) The Authority shall notify and inform the International Civil Aviation organization and other States concerned with the transfer arrangement of the existence of the agreement.

(6) In this section the term **“registered aircraft”** means-

(a) aircraft registered in Nigeria and operated pursuant to an agreement for the lease, charter, or interchange of the aircraft or any similar arrangement by an operator that has its principal place of business or, if it has no such place of business, its permanent residence in another country; and

(b) aircraft registered in a foreign country and operated under an agreement for the lease, charter, or interchange of the aircraft or any similar arrangement by an operator that has its principal place of business or, if it has no such place of business, its permanent residence in Nigeria.

#### **69. Regional co-operative aviation safety agreements**

(1) The Authority shall encourage regional co-operation in the regulation and administration of aviation safety.

(2) The Authority may, pursuant to subsection (1) of this section enter into agreements for cooperative endeavours in aviation safety with other regional contracting States to the Convention on International Civil Aviation and the Authority in conjunction with the Ministry in charge of civil aviation shall negotiate, agree to and manage such regional co-operative agreements.

(3) The Authority may in the interest of public safety and the safety of civil aviation, delegate certain aviation safety tasks under the co-operative agreement to citizens of Nigeria and citizens of the other state party in the agreement.

#### **70. Aviation safeguards**

(1) The Authority, subject to the approval of the Minister may, by regulation, make such provisions as it deems necessary, to prohibit and/or discourage anti-competitive practices.

(2) Without prejudice to the generality of subsection (1) of this section, such practices may include-

(a) charging fares and rates on routes at levels which are in aggregate insufficient to cover the costs of providing the services to which they relate;

(b) the addition of excessive capacity or frequency of service;

(c) practices which have a serious negative economic effect on, or cause significant damage to, another airline;

(d) practices which reflect an apparent intent or have the probable effect, of crippling, excluding or driving another airline or allied aviation service provider from the market; and

(e) any behaviour indicating an abuse of dominant position on a route or routes or in respect of any allied service.

#### **71. Compensation schemes for passengers and other allied aviation services consumers**

(1) The Authority shall formulate schemes for suitable compensation of passengers and other aviation and allied service consumers arising from different forms of grievances.

(2) The regulations under subsection (1) of this section shall be formulated after holding consultations with air carriers and other stake holders.

#### **72. Regulation of sale, distribution and provision of allied services**

(1) All persons engaged in the sale, distribution and provision of allied services shall obtain such license, permit or authorization from the Authority as may be specified.

(2) The Authority may make rules in this behalf, which may, *inter alia*, include;

(a) the categories including (but not limited) to aircraft equipment sale or leasing operations, in-flight catering services, ground handling, amongst others in which the license may be granted;

- (b) the information to be furnished by an applicant for the license;
- (c) the terms and conditions subject to which the license may be granted
- (d) the circumstances under which the license may be suspended or revoked

### **73. Application of certain conventions**

(1) The provisions of the Convention on the International Recognition of Rights in Aircraft (Geneva Convention), 1948 set out in the Fourth Schedule to this Act, and as amended from time to time, shall from the commencement of this Act have the force of law in Nigeria subject to subsection (2) of this section.

[Fourth Schedule]

(2) The provisions of the Convention on International Interests in Mobile Equipment 2001 and the Protocol to the Convention on International Interests in Mobile Equipment on matters specific to aircraft equipment 2001 (the Cape Verde Convention and Protocol) set out in the Fifth Schedule (a) and (b) respectively, shall from the commencement of this Act, have the force of law in Nigeria.

[Fifth Schedule]

Provided however, that the Minister of Aviation shall have power to from time to time make declarations required or permitted to be made under the Convention and Protocol.

### **74. Insurance**

(1) Any carrier operating air transport services to, from or within Nigeria, or aerodrome operator, aviation fuel supplier, or any provider of ground handling services, meteorological services, air traffic control services, aircraft maintenance services, or provider of such other class of allied service as the Authority may from time to time determine in writing shall maintain adequate insurance covering its liability under this Act and also its liability towards compensation for damages that may be sustained by third parties for an amount to be specified in regulations made by the Authority.

(2) Absence of such insurance shall be sufficient reason for refusal, suspension or revocation of the permission to operate the air transport service or services in question.

(3) Any person having a duty to maintain adequate insurance pursuant to the provision of subsection (1) of this section shall make quarterly returns to the Authority evidencing that such adequate insurance is maintained and that all conditions necessary to create an obligation on the insurer to provide indemnity in the event of a loss have for the time being been fulfilled.

(4) Any carrier operating air transport services to, from or within Nigeria, or aerodrome operator, aviation fuel supplier, or any provider of ground services, air traffic control services, aircraft maintenance services, who contravenes the provisions of subsections (1) and (3) of this section,

commits an offence and is liable on conviction to a fine of not less than Ten million Naira and its Principal Officers shall be liable to imprisonment for a term of not less than two years.

#### **75. Air services agreement**

All funds accruing from or as a result of air services agreements entered into by Nigeria whether multilateral or bilateral shall be paid to the Authority and maintained in a separate account to be used solely for the development of Civil Aviation in Nigeria in accordance with regulations made by the Minister and appropriation by the National Assembly.

#### **76. Periodic Publication of aviation policy**

(1) The Minister may publish from time to time a statement of the policies of the Government of the Federal Republic of Nigeria on civil aviation.

(2) If the Minister considers it appropriate to do so, he may by notice in writing, require the Authority to publish a statement of the policy it intends to adopt with respect to any particular matter in exercising the powers and performing the functions conferred upon it under this Act and it shall be the duty of the Authority to publish the statement required by such a notice.

(3) Before publishing any statement under this section, the Authority shall consult such persons as appear to it to be representative respectively-

(a) of the civil aviation industry of Nigeria; and

(b) of users of air transport services.

(4) The manner of publication of any statement under this section shall be as the Authority may determine.

#### **77. Repeals and saving provisions**

(1) Subject to the provisions of subsection (2) of this section, the following enactments are hereby repealed;

(a) Carriage by air (Colonies, Territories and other Trust Territories) Colonial Order 1953;

(b) Civil Aviation Act, Cap. 51 LFN 1990;

(c) Civil Aviation (Amendment) Act, 1999; and

(d) Nigerian Civil Aviation Authority (Establishment) Act, No. 49 1999.

(2) All regulations, by-laws, orders and subsidiary legislation made under the Civil Aviation Act, 1964 Cap. 511. FN 1990) shall continue to be in force until new regulations, by-laws, orders and subsidiary legislation are made pursuant to this Act.

#### **78. Definitions**

(1) In this Act-

**“aerodrome”** means a defined area of land on land or water (including any buildings, installations, and equipment) intended to be used either wholly or in part for the arrival, departure and surface movement of aircraft;

**“aircraft”** means any machine that can derive support in the atmosphere from reactions of the air other than reactions of the air against the earth’s surface;

**“air navigation services”** includes information, direction and other facilities furnished, issued or provided in connection with the navigation or movement of aircraft and the control of movement of vehicles in any part of an aerodrome used for the movement of aircraft;

**“allied aviation business”** includes aircraft equipment sale or leasing operations, in-flight catering services, ground handling operations and other businesses connected with or ancillary to civil aviation;

**“Authority”** means the Nigerian Civil Aviation Authority established by Section 2 (1) of this Act;

**“cargo”** means any property carried on an aircraft other than mail stores and accompanied or mishandled baggage;

**“Chicago Convention”** means the Convention on International Civil Aviation concluded at Chicago on the 7th December, 1944, any Annex which relates to international standards and recommended practices and is adopted in accordance with the Convention and any amendment of the Convention or of such Annex which is made in accordance with the Convention;

**“civil aviation operations”** includes Ground Handling operations, air operations, aerodrome operations, Meteorological Services, Air traffic control and provision of Navigational Aids, Catering and allied services;

**“Director-General”** means the Director-General of the Authority;

**“flight”** means a journey by air beginning from the moment when all the external doors of an aircraft are closed following embarkation until the moment when any such doors are opened for disembarkation. In the case of a forced landing, the flight shall be deemed to continue until the competent authorities take over the responsibility for the aircraft and for persons and property on board;

**“foreign aircraft”** means an aircraft other than a Nigerian registered aircraft;

**“ICAO”** means International Civil Aviation Organization established under the Convention on International Civil Aviation 1944;

**“license”** Includes Air Transport License (AIL), Air operators Permit (AOP), Air Travellers Organizers License (ATOL), Air Operators Certificate (AOC), Certificates of Airworthiness, Certificate of Registration, Personnel Licenses and Ratings, Aerodrome license, Aviation Training Organizations



Approvals/Certificates, Aircraft Maintenance Organization approvals/certificates and all other authorizations and approvals issued pursuant to this Act;

“**mail**” means dispatches of correspondence and other items tendered by and intended for delivery to postal services in accordance with the rules of the Universal Postal Union;

“**member**” means a member of the Governing Board of the authority and includes the Chairman;

“**Minister**” means the Minister of the Government of the Federation responsible for Civil Aviation;

“**Nigerian aircraft**” means an aircraft registered in Nigeria in pursuance of regulations made under this Act;

“**premises**” includes lands, plants, and ancillary works;

“**prescribed**” means prescribed by regulations made under this Act;

“**regulations**” in this Act is a reference to all subsidiary legislation made pursuant to this Act; and

“**reward**” in relation to a flight includes any form of consideration received or required to be received wholly or partly in connection with the flight irrespective of the person by whom or to whom the consideration has been or is to be given.

(2) Every other term shall have the same meaning as contained in the Chicago Convention.

#### **79. Short Title.**

This Act may be cited as the Civil Aviation Act, 2006.

---

### SCHEDULE

#### FIRST SCHEDULE

[Section 56 (1)]

#### *Convention for the Suppression of Unlawful Seizure of Aircraft, 1993*

#### PREAMBLE

#### THE STATE PARTIES TO THIS CONVENTION

CONSIDERING that unlawful acts of seizure or exercise of control of aircraft in flight jeopardize the safety of persons and property seriously affects the operation of air services, and undermine the confidence of the peoples of the world is the safety of civil aviation;

CONSIDERING that the occurrence of such acts is a matter of grave concern;

CONSIDERING that, for the purpose of deterring such acts, there is an urgent need to provide appropriate measures for punishment of offenders;

HAVE AGREED AS FOLLOWS

#### ARTICLE 1

Any person who on board an aircraft in flight-

unlawfully, by force or threat thereof, or by any other form of intimidation, seizes, or exercises control of, that aircraft, or attempts to perform any such act; or

is an accomplice of a person who performs or attempts to perform any such act commits an offence (here-in-after referred to as "the offence").

#### ARTICLE 2

Each Contracting State undertakes to make the offence punishable by severe penalties.

#### ARTICLE 3

**1.** For the purposes of this Convention, an aircraft is considered to be in flight at any time from the moment when all its external doors are closed following embarkation until the moment when any such door is opened for disembarkation. In the case of a forced landing, the flight shall be deemed to continue until the competent authorities take over the responsibility for the aircraft and for persons and property on board.

**2.** This Convention shall not apply to aircraft used in military, customs or police services.

**3.** This Convention shall apply only if the place of take-off or the place of actual landing, if the aircraft on board which the offence is committed is situated outside the territory of the State of registration of that aircraft; it shall be immaterial whether the aircraft is engaged in an international or domestic flight.

**4.** In the cases mentioned in Article 5, this Convention shall not apply if the place of take-off and the place of actual landing of the aircraft on board which the offence is committed are situated within the territory of the same State where that State is one of those referred to in that Article.

**5.** Notwithstanding paragraphs 3 and 4 of this Article, Articles 6, 7, 9 and 10 shall apply whatever the place of take-off or the place of actual landing of the aircraft, if the offender or the alleged offender is found in the territory of a State other than the State of registration of the aircraft.

#### ARTICLE 4

**1.** Each Contracting State shall take such measures as may be necessary to establish its jurisdiction over the offence and any other act of violence against passengers or crew committed by the alleged offender in connection with the offence, in the following cases

- (a) when the offence is committed on board an aircraft registered in that State;
- (b) when the aircraft on board which the offence is committed lands in its territory with the alleged offender still on board :
- (c) when the offence is committed on board an aircraft leased without crew to a lessee who has his principal place of business or if the lessee has no such place of business, his permanent residence, in that State.

**2.** Each Contracting State shall likewise take such measures as may be necessary to establish its jurisdiction over the offence in the case where the alleged offender is present in its territory and it does not extradite him pursuant to Article 8 to any of the States mentioned in paragraph 1 of this Article.

**3.** This Convention does not exclude any criminal jurisdiction exercised in accordance with national law.

#### ARTICLE 5

The Contracting States which establish joint air transport operating organizations or international operating agencies, which operate aircraft which are subject to joint or international registration shall, by appropriate means, designate for each aircraft the State among them which shall exercise the jurisdiction and have the attributes of the State of registration for the purpose of this Convention and shall give notice thereof to the International Civil Aviation Organization which shall communicate the notice to all States Parties to this Convention.

#### ARTICLE 6

**1.** Upon being satisfied that the circumstances so warrant any Contracting State in the territory of which the offender or the alleged offender is present shall take him into custody or take other measures to ensure his presence. The custody and other measures shall be as provided in the law of that State but may only be continued for such time as is necessary to enable any criminal or extradition proceedings to be instituted.

**2.** Such State shall immediately make a preliminary enquiry into the fact.

**3.** Any person in custody pursuant to paragraph 1 of this Article shall be assisted in communicating immediately with the nearest appropriate representative of the State of which he is a national.

**4.** When a State, pursuant to this Article, has taken a person into custody it shall immediately notify the State of registration of the aircraft, the State mentioned in Article 4, Paragraph 1 (c), the State of nationality of detained person and, if it considers it advisable, any other interested State of the fact that such person is in custody and of the preliminary enquiry contemplated in paragraph 2 of this Article shall promptly report its findings to the said State and shall indicate whether it intends to exercise jurisdiction.

#### ARTICLE 7

The Contracting State in the territory of which the alleged offender found shall, if it does not extradite him, be obliged, without exception whatsoever and whether or not the offence was committed in its territory to submit the case to its competent authorities for the purpose of prosecution. Those authorities shall take their decision in the same manner as in the case of any ordinary offence of a serious nature under the law of that State.

#### ARTICLE 8

- 1.** The offence shall be deemed to be included as an extraditable offence in any extradition treaty existing between Contracting States. Contracting States undertake to include the offence as an extraditable offence in every extradition treaty to be concluded between them.
- 2.** If a Contracting State which makes extradition conditional on the existence of a treaty services a request for extradition from another Contracting State with which it has no extradition treaty, it may at its option consider this Convention as the legal basis for extradition in respect of the offence. Extradition shall be subject to the other conditions provided by the law of the requested State.
- 3.** Contracting States which do not make extradition conditional on the existence of a treaty shall recognize the offence as an extraditable offence between themselves subject to the conditions provided by the law of the requested State.
- 4.** The offence shall be treated, for the purpose of extradition between Contracting States, as if it had been committed not only in the place in which it occurred but also in the territories of the States required to establish their jurisdiction in accordance with Article 4, paragraph 1.

#### ARTICLE 9

- 1.** When any of the acts mentioned in Article 1 (a) has occurred or is about to occur, Contracting States shall take all appropriate measures to restore control of the aircraft to its lawful commander or to preserve his control of the aircraft.
- 2.** In the cases contemplated by the preceding paragraph, any Contracting State in which the aircraft or its passengers or crew are present shall facilitate the continuation of the journey of the passengers and crew as soon as practicable, and shall without delay return the aircraft and its cargo to the persons lawfully entitled to possession.

#### ARTICLE 10

- 1.** Contracting States shall afford one another the greatest measure of assistance in connection with criminal proceedings brought in respect of the offence and other acts mentioned in Article 4. The law of the State requested shall apply in all cases.
- 2.** The provisions of paragraph 1 of this Article shall not affect obligations under any other treaty bilateral or multilateral, which governs or will govern, in whole or in part, mutual assistance in criminal matters.

#### ARTICLE 11

Each Contracting State shall in accordance with its national law report to the Council of the international Civil Aviation Organization as promptly as possible any relevant information in its possession concerning-

the circumstances of the offence;

the action taken pursuant In Article 9;

the measures taken in relation to the offender or the alleged offender: and

in particular the results of any extradition proceedings or other legal proceedings.

#### ARTICLE 12

- 1.** Any dispute between two or more Contracting States concerning the interpretation or application of this Convention which cannot be settled through negotiation, shall at the request of one of them, be submitted to the Parties and if the parties are unable to agree on the organization or the arbitration, any one of those Parties may refer the dispute to the International Court of Justice by request in conformity with the Statute of the Court.
- 2.** Each state may at the time of signature or ratification of this convention or accession thereto, declare that it does not consider itself bound by the preceding paragraph. The other Contracting States shall not be bound by the preceding paragraph with respect to any Contracting State having made such a reservation.
- 3.** Any Contracting State having made a reservation in accordance with the preceding paragraph may at any time withdraw this reservation by notification to the Depository Governments.

#### ARTICLE 13

- 1.** This Convention shall be open for signature at The Hague on 16th December, 1970, by the States participating in the International Conference on Air Law held at The Hague from 1st to 16th December 1970 (hereinafter referred to as the Hague Conference). After 31st December, 1970, the Convention shall be open to all States for signature in Moscow, London and Washington. Any State which does not sign this Convention before its entry into force in accordance with paragraph 3 of this Article may accede to it at any time.
- 2.** This Convention shall be subject to ratification by the signatory States. Instruments of ratification and instruments of accession shall be deposited with Governments of the Union of Soviet Socialist Republics, the United Kingdom of Great Britain and Northern Ireland, and the United States of America which are hereby designated the Depository Governments.
- 3.** This Convention shall enter into force thirty days following the date of the deposit of instruments of ratification by ten States signatory to this Convention which participated in The Hague Conference.

4. For other States, this Convention shall enter into force on the date of entry into force of this Convention in accordance with paragraph 3 of this Article, or thirty days following the date of deposit of their instruments of ratification or accession, whichever is later.

5. The Depository Governments shall promptly inform all signatory and acceding States of the date of each signature, the date of deposit of each instrument of ratification or accession, the date of entry into force of this Convention, and other notices.

6. As soon as this Convention comes into force, it shall be registered by the Depository Governments pursuant to Article 102 of the Charter of the United Nations and pursuant to Article 83 of the Convention on International Civil Aviation (Chicago, 1994)

#### ARTICLE 14

1. Any Contracting State may denounce this Convention by written notification to the Depository Governments.

2. Denunciation shall take effect six months following the date on which notification is received by the Depository Governments.

IN WITNESS WHEREOF the undersigned Plenipotentiaries, being duly authorized thereto by their Governments, have signed this Convention.

DONE at The Hague, this sixteenth day of December, one thousand, nine hundred and seventy, in three originals, each being drawn up in four authentic texts in the English, French, Russian and Spanish languages.

---

#### SECOND SCHEDULE

[Section 48 (1).]

*Convention for the Unification of certain Rules relating to International Carriage by Air*

*(Montreal, 1999)*

#### THE STATES PARTIES TO THIS CONVENTION

RECOGNISING the significant contribution of the convention for the Unification of Certain Rules Relating to international Carriage by Air signed in Warsaw on 12th October, 1929, hereinafter referred to as the "Warsaw Convention," and other related instruments to the harmonization of private international air law;

RECOGNISING the need to modernize and consolidate the Warsaw Convention and related instruments;

RECOGNISING the importance of ensuring protection of the interests of consumers in international carriage by air and the need for equitable compensation based on the principle of restitution;

REAFFIRMING the desirability of an orderly development of international air transport operations and the smooth flow of passengers, baggage and cargo in accordance with the principles and objectives of the Convention Of International Civil Aviation, done at Chicago on 7th December, 1944;

CONVINCED that collective State action for further harmonization and codification of certain rules governing international carriage by air through a new convention is the most adequate means of achieving an equitable balance of interests;

HAVE AGREED AS FOLLOWS:

## CHAPTER 1

### *General Provisions*

#### ARTICLE 1

##### *Scope of Application*

- 1.** This Convention applies to all international carriage of persons, baggage or cargo performed by aircraft for reward. It applies equally to gratuitous carriage by aircraft performed by an air transport undertaking.
- 2.** For the purposes of this Convention, the expression “**international carriage**” means any carriage in which, according to agreement between the parties, the place of departure and the place of destination, whether or not there be a break in the carriage or a transshipment, are situated either within the territories of two States Parties, or within the territory of a single State Party if there is an agreed stopping place within the territory of another State, even if that State is not a State party. Carriage between two points within the territory of a single State Party without an agreed stopping place within the territory of another State is not international carriage for the purposes of this Convention.
- 3.** Carriage to be performed by several successive carriers is deemed, for the purposes of this Convention, to be one undivided carriage if it has been regarded by the parties as a single operation, whether it had been agreed upon under the form of a single contract or of a series of contracts and it does not lose its international character merely because one contract or a series of contracts is to be performed entirely within the territory of the same State.
- 4.** This Convention applies also to carriage as set out in Chapter V, subject to the terms contained therein.

#### ARTICLE 2

##### *Carriage Performed by State and Carriage of Postal Items*

1. This Convention applies to carriage performed by the State or by legally constituted public bodies provided it falls within the conditions laid down in Article 1.
2. In the carriage of postal items, the carrier shall be liable only to the relevant postal administration in accordance with the rules applicable to the relationship between the carriers and the postal administrations.
3. Except as provided in paragraph 2 of this Article, the provisions of this Convention shall not apply to the carriage of postal items.

## CHAPTER II

### *Documentation and Duties of the Parties relating to the Carriage of Passengers,*

#### *Baggage and Cargo*

## ARTICLE 3

### *Passenger and Baggage*

1. In respect of carriage of passengers, individual or collective document of carriage shall be delivered containing-
  - (a) an indication of the places of departure and destination;
  - (b) if the places of departure and destination are within the territory of a single State Party, one or more agreed stopping places being within the territory of another State, an indication of at least one such stopping place.
2. Any other means which preserves the information indicated in paragraph 1 may be substituted for the delivery of the document referred to in that paragraph. If any such other means is used, the carrier shall offer to deliver to the passenger a written statement of the information so preserved.
3. The carrier shall deliver to the passenger a baggage identification tag for each piece of checked baggage.
4. The passenger shall be given written notice to the effect that where this Convention is applicable it governs and may limit the liability of carriers in respect of death or injury and for destruction or loss of, or damage to, baggage, and for delay.
5. Non-compliance with the provisions of the foregoing paragraphs shall not affect the existence or the validity of the contract of carriage, which shall nonetheless, be subject to the rules of this Convention including those relating to limitation of liability.

## ARTICLE 4

### *Cargo*



1. In respect of the carriage of cargo, an air waybill shall be delivered.
2. Any other means which preserves a record of the carriage to be performed may be substituted for the delivery of an air waybill. If such other means are used, the carriage shall, if so requested by the consignor, deliver to the consignor a cargo receipt permitting identification of the consignment and access to the information contained in the record preserved by such other means.

#### ARTICLE 5

##### *Contents of air Waybill or Cargo Receipt*

The air waybill or the cargo receipt shall include-

- (a) an identification of the places of departure and destination;
- (b) if the places of departure and destination are within the territory of a single State party, one or more agreed stopping places being within the territory of another State, an indication of at least one such stopping place; and
- (c) an indication of the weight of the consignment.

#### ARTICLE 6

##### *Document relating to the Nature of the Cargo*

The consignor may be required if necessary to meet the formalities of customs, police and similar public authorities, to deliver a document indicating the nature of the cargo. This provision creates for the carrier no duty, obligation or liability therefrom.

#### ARTICLE 7

##### *Description of Air Waybill*

1. The air waybill shall be made out by the consignor in three original parts.
2. The first part shall be marked "for the carrier"; it shall be signed by the consignor. The second part shall be marked "for the consignee"; it shall be signed by the consignor and by the carrier. The third part shall be signed by the carrier who shall hand it to the consignor after the cargo has been accepted.
3. The signature of the carrier and that of the consignor may be printed or stamped.
4. If, at the request of the consignor, the carrier makes out the air waybill, the carrier shall be deemed, subject to proof to the contrary, to have done so on behalf of the consignor.

#### ARTICLE 8

##### *Documentation for Multiple Packages*

When there is more than one package-

- (a) the carrier of cargo has the right to require the consignor to make out separate air waybills;
- (b) the consignor has the right to require the carrier to deliver separate cargo receipts when the other means referred to in paragraph 2 of Article 4 are used.

## ARTICLE 9

### *Non-compliance with Documentary Requirements*

Non-compliance with the provisions of Articles 4 to 8 shall not affect the existence or the validity of the contract of carriage which shall, nonetheless, be subject to the rules of this Convention including those relating to limitation of liability.

## ARTICLE 10

### *Responsibility for Particulars of Documentation*

- 1.** The consignor is responsible for the correctness of the particulars and statements relating to the cargo inserted by it or on its behalf in the air waybill or furnished by it or on its behalf to the carrier for insertion in the cargo receipt or for insertion in the record preserved by the other means referred to in paragraph 2 of Article 4. The foregoing shall also apply, where the person acting on behalf of the consignor is also the agent of the carrier.
- 2.** The consignor shall indemnify the carrier against all damage suffered by it, or by any other person to whom the carrier is liable, by reason of the irregularity, incorrectness or incompleteness of the particulars and statements furnished by the consignor or on its behalf.
- 3.** Subject to the provisions of paragraphs 1 and 2 of this Article, the carrier shall indemnify the consignor against all damages suffered by it, or by any other person to whom the consignor is liable, by reason of the irregularity, incorrectness or incompleteness of the particulars and statement inserted by the carrier or on its behalf in the cargo receipt or in the record preserved by the other means referred to in paragraph 2 of Article 4.

## ARTICLE 11

### *Evidentiary Value of Documentation*

- 1.** The air waybill or the cargo receipt is prima facie evidence of the conclusion of the contract, of the acceptance of the cargo and of the conditions of carriage mentioned therein.
- 2.** Any statements in the air waybill or the cargo receipt relating to the weight, dimensions and packaging of the cargo, as well as those relating to the number of packages, are prima facie evidence of the facts stated; those relating to the quantity, volume and condition of the cargo do not constitute evidence against the carrier except so far as they both have been, and are stated in the air waybill or the

cargo receipt to have been, checked by it in the presence of the consignor, or relate to the apparent condition of the cargo.

## ARTICLE 12

### *Right of Disposition of Cargo*

1. Subject to its liability to carry out all its obligations under the contract of carriage, the consignor has the right to dispose of the cargo by withdrawing it at the airport of departure or destination, or by stopping it in the course of the journey on any landing, or by calling for it to be delivered at the place of destination or in the course of the journey to a person other than the consignee originally designated, or by requiring it to be returned to the airport of departure. The consignor must not exercise this right of disposition in such a way as to prejudice the carrier or other consignors and must reimburse any expenses occasioned by the exercise of this right.
2. If it is impossible to carry out the instructions of the consignor, the carrier must so inform the consignor forthwith.
3. If the carrier carries out the instructions of the consignor for the disposition of the cargo without requiring the production of the part of the air waybill or the cargo receipt delivered to the latter, the carrier will be liable, without prejudice to its right of recovery from the consignor, for any damage which may be caused thereby to any person who is lawfully in possession of that part of the air waybill or the cargo receipt.
4. The right conferred on the consignor ceases at the moment when that of the consignee begins in accordance with Article 13. Nevertheless, if the consignee declines to accept the cargo, or cannot be communicated with, the consignor resumes its right of disposition.

## ARTICLE 13

### *Delivery of the Cargo*

1. Except when the consignor has exercised its right under Article 12, the consignee is entitled, on arrival of the cargo at the place of destination, to require the carrier to deliver the cargo to it, on payment of the charges due and on complying with the conditions of carriage.
2. Unless it is otherwise agreed, it is the duty of the carrier to give notice to the consignee as soon as the cargo arrives.
3. If the carrier admits the loss of the cargo, or if the cargo has not arrived at the expiration of seven days after the date on which it ought to have arrived, the consignee is entitled to enforce against the carrier the rights which flow from the contract of carriage.

## ARTICLE 14

### *Enforcement of the Rights of Consignor and Consignee*

The consignor and the consignee can respectively enforce all the rights given to them by article 12 and 13, each in its own name, whether it is acting in its own interest or in the interest of another, provided that it carries out the obligations imposed by the contract of carriage.

#### ARTICLE 15

##### *Relations of Consignor and Consignee or Mutual Relations of third Parties*

1. Articles 12, 13 and 14 do not affect either the relations of the consignor and the consignee with each other or the mutual relations of third parties whose rights are derived either from the consignor or from the consignee.
2. The provisions of Articles 12, 13 and 14 can only be varied by express provisions in the air waybill or the cargo receipt.

#### ARTICLE 16

##### *Formalities of Customs, Police or Other Public Authorities*

1. The consignor must furnish such information and such documents as are necessary to meet the formalities of customs, police and any other public authorities before the cargo can be delivered to the consignee. The consignor is liable to the carrier for any damage occasioned by the absence, insufficiency or irregularity of any such information or documents, unless the damage is due to the fault of the carrier, its servants or agents.
2. The carrier is under no obligation to enquire into the correctness or sufficiency of such information or documents.

#### CHAPTER III

##### *Liability of the Carrier and Extent of, Compensation for Damage*

#### ARTICLE 17

##### *Death and Injury of Passengers-Damage of Baggage*

1. The carrier is liable for damage sustained in case of death or bodily injury of a passenger upon condition only that the accident which caused the death or injury took place on board the aircraft or in the course of any of the operations of embarking or disembarking.
2. The carrier is liable for damage sustained in case of destruction or loss of, or of damage to, checked baggage upon condition only that the event which caused the destruction, loss or damage took place on board the aircraft or during any period within which the checked baggage was in the charge of the carrier. However, the carrier is not liable if and to the extent that the damage resulted from the inherent defect, quality or vice of the baggage. In the case of unchecked baggage, including personal items, the carrier is liable if the damage resulted from its fault or that of its servants or agents.

3. If the carrier admits the loss of the checked baggage, or if the checked baggage has not arrived at the expiration of the twenty-one days after the date on which it ought to have arrived, the passenger is entitled to enforce against the carrier the rights which flow from the contract of carriage.

4. Unless otherwise specified, in this Convention the term “**baggage**” means both checked baggage and unchecked baggage.

## ARTICLE 18

### *Damage to Cargo*

The carrier is liable for damage sustained in the event of the destruction or loss of, or damage to cargo upon condition only that the event which caused the damage so sustained took place during the carriage by air.

However, the carrier is not liable if and to the extent it proves that the destruction, or loss of, or damage to, the cargo resulted from one or more of the following -

(a) inherent defect, quality or vice of that cargo;

(b) defective packing of that cargo performed by a person other than the carrier or its servants or agents;

(c) an act of war or an armed conflict;

(d) an act of public authority carried out in connection with the entry, exit or transit of the cargo.

3. The carriage by air within the meaning of paragraph 1 of this Article comprises the period during which the cargo is in the charge of the carrier.

4. The period of the carriage by air does not extend to any carriage by land, by sea or by inland waterway performed outside an Airport. If, however, such carriage takes place in the performance of a contract for carriage by air, for the purpose of loading, delivery or transshipment, any damage is presumed, subject to proof to the contrary, to have been the result of an event which took place during the carriage by air. If a carrier, without the consent of the consignor, substitutes carriage by another mode of transport for the whole or part of a carriage intended by the agreement between the parties to be carriage by air, such carriage by another mode of transport is deemed to be within the period of carriage by air.

## ARTICLE 19

### *Delay*

The carrier is liable for damage occasioned by delay in the carriage by air of passengers, baggage or cargo. Nevertheless, the carrier shall not be liable for damage occasioned by delay if it proves that it and its servants and agents took all measures that could reasonably be required to avoid the damage or that it was impossible for it or them to take such measures.

## ARTICLE 20

### *Exoneration*

If the carrier proves that the damage was caused or contributed to by the negligence or other wrongful act or omission of the person claiming compensation, or the person from whom he or she derives his or her rights, the carrier shall be wholly or partly exonerated from its liability to the claimant to the extent that such negligence or wrongful act or omission caused or contributed to the damage. When by reason of death or injury of a passenger, compensation is claimed by a person other than the passenger, the carrier shall likewise be wholly or partly exonerated from its liability to the extent that it proves that the damage was caused or contributed to by the negligence or other wrongful act or commission of that passenger. This Article applies to all the liability provisions in this Convention, including paragraph 1 of Article 21.

## ARTICLE 21

### *Compensation in case of Death or Injury of Passengers*

1. For damage arising under paragraph 1 of Article 17 not exceeding 100,000.00 United States dollars for each passenger, the carrier shall not be able to exclude or limit its liability.
2. The carrier shall not be liable for damages arising under paragraph 1 of Article 17 to the extent that they exceed for each passenger 100,000 United States dollars if the carrier proves that-
  - (a) such damage was not due to the negligence or other wrongful act or omission of the carrier or its servants or agents; or
  - (b) such damage was solely due to the negligence or other wrongful act or omission of a third party.

## ARTICLE 22

### *Limits of Liability in relation to Delay, Baggage and Cargo*

1. In the case of damage caused by delay as specified in Article 19 in the carriage of persons, the liability of the carrier for each passenger is limited to 4,150 United States Dollars.
2. In the carriage of baggage, the liability of the carrier in the case of destruction, loss, damage or delay is limited to 1,000 United States Dollars for each passenger unless the passenger has made, at the time when the checked baggage was handed over to the carrier, a special declaration of interest in delivery at destination and has paid a supplementary sum if the case so requires. In that case, the carrier will be liable to pay a sum not exceeding the declared sum, unless it proves that the sum is greater than the passenger's actual interest in delivery at destination.
3. In the carriage of Cargo, the liability of the carrier in the case of destruction, loss, damage or delay is limited to a sum of 20 United States Dollars per kilogram, unless the consignor has made, at the time when the package was handed over to the carrier, a special declaration of interest in delivery at

destination and has paid a supplementary sum if the case so requires. In that case the carrier will be liable to pay a sum not excluding the declared sum, unless it proves that the sum is greater than the consignors actual interest in delivery at destination.

4. In the case of destruction, loss, damage or delay of part of the cargo, or of any object contained therein, the weight to be taken into consideration in determining the amount to which the carrier's liability is limited shall be only the total weight of the package or packages concerned. Nevertheless, when the destruction, loss, damage or delay of a part of the cargo, or of an object contained therein, affects the value of other packages covered by the same air waybill or the same receipt or, if they were not issued, by the same record preserved by the other means referred to in paragraph 2 of Article 4, the total weight of such package or packages shall also be taken into consideration in determining the limit of liability.

5. The foregoing provisions of paragraphs 1 and 2 of this Article shall not apply if it is proved that the damage resulted from an act or omission of the carrier, its servants or agents, done with intent to cause damage or recklessly and with knowledge that damage would probably result; provided that, in the case of such act or omission of a servant or agent, it is also proved that such servants or agent was acting within the scope of its employment.

6. The limits prescribed in Article 21 and in this Article shall not prevent the Court from awarding, in accordance with its own law, in addition, the whole or part of the court costs and of the other expenses of the litigation incurred by the Plaintiff, including interest. The foregoing provision shall not apply if the amount of the damages awarded, excluding Court costs and other expenses of the litigation, does not exceed the sum which the carrier has offered in writing to the Plaintiff within a period of six months from the date of the occurrence causing the damage, or before the commencement of the action, if that is later.

#### ARTICLE 23

##### *Conversion of Monetary Units*

1. The sums mentioned in Articles 21 and 22 shall be converted to naira at the existing official exchange rate.

#### ARTICLE 24

##### *Review of Limits*

1. Without prejudice to the provisions of Article 25 of this Convention, the limits of liability prescribed in Articles 21, 22 and 23 shall be reviewed by the Minister of Aviation upon advice by the Nigerian Civil Aviation Authority at seven-year intervals, the first such review to take place at the end of the seventh year following the date of entry into force of this Act.

#### ARTICLE 25

### *Stipulation on Limits*

A carrier may stipulate that the contract of carriage shall be subject to higher limits of liability than those provided for in this Convention or to no limits of liability whatsoever.

### ARTICLE 26

#### *Invalidity of Contractual Provisions*

Any provision tending to relieve the carrier of liability or to fix a lower limit than that which is laid down in this Convention shall be null and void, but the nullity of any such provision does not involve the nullity of the whole contract, which shall remain subject to the provisions of this convention.

### ARTICLE 27

#### *Freedom to Contract*

Nothing contained in this Convention shall prevent the carrier from refusing to enter into any contract of carriage, from waiving any defences available under the Convention, or from laying down conditions which do not conflict with the provisions of this Convention.

### ARTICLE 28

#### *Advance Payments*

In the case of aircraft accidents resulting in death or injury of passengers, the carrier shall, if required by its national law, make advance payments without delay to a natural person or persons who are entitled to claim compensation in order to meet the immediate economic needs of such persons. Such advance payments shall not constitute recognition of liability and may be offset against any amounts subsequently paid as damages by the carrier.

### ARTICLE 29

#### *Basis of Claims*

In the carriage of passengers, baggage and cargo, any action for damages, however founded, whether under this convention or in contract or in tort or otherwise, can only be brought subject to the conditions and such limits of liability as are set out in this Convention without prejudice to the question as to who are persons who have the right to bring suit and what are their respective rights. In any such action, punitive, exemplary or any other non-compensatory damages shall not be recoverable.

### ARTICLE 30

#### *Servants, Agents - Aggregation of Claims*

1. If an action is brought against a servant or agent of the carrier arising out of damage to which the Convention relates, such servant or agent, if they prove that they acted within the scope of their



employment, shall be entitled to avail themselves of the conditions and limits of liability which the carrier itself is entitled to invoke under this Convention.

**2.** The aggregate of the amounts recoverable from the carrier, its servants and agents, in that case, shall not exceed the said limits.

**3.** Save in respect of the carriage of cargo, the provisions of paragraph 1 and 2 of this Article shall not apply if it is proved that the damage resulted from an act or omission of the servant or agent done with intent to cause damage recklessly and with knowledge that damage would probably result.

#### ARTICLE 31

##### *Timely Notice of Complaint*

**1.** Receipt by the person entitled to delivery of checked baggage or cargo without complaint is *Prima Facie* evidence that the same has been delivered in good condition and in accordance with the document of carriage or with the record preserved by the other means referred to in paragraph 2 of Article 3 and paragraph 2 of Article 4.

**2.** In the case of damage, the person entitled to delivery must complain to the carrier forthwith after the discovery of the damage, and, at the latest, within seven days from the date of receipt in case of cargo. In the case of delay, the complaint must be made at latest within fourteen days from the date on which the baggage or cargo have been placed at his or her disposal.

**3.** Every complaint must be made in writing and given or dispatched within times aforesaid.

**4.** If no complaint is made within the times aforesaid, no action shall lie against the carrier, save in the case of fraud on its part.

#### ARTICLE 32

##### *Death of Person Liable*

In the case of the death of the person liable, an action for damages lies in accordance with the terms of this Convention against those legally representing his or her estate.

#### ARTICLE 34

##### *Arbitration*

**1.** Subject to the provisions of this Article, the parties to the contract of carriage for cargo may stipulate that any dispute relating to the liability of the carrier under this Convention shall be settled by arbitration. Such agreement shall be in writing.

**2.** The arbitrator or arbitral tribunal shall apply the provisions of this Convention.

4. The provisions of paragraphs 2 and 3 of this Article shall be deemed to be part of every arbitration clause or agreement, and any term of such clause or agreement which is inconsistent therewith shall be null and void.

#### ARTICLE 35

##### *Limitation of Actions*

The right to damages shall be extinguished if an action is not brought within a period of two years, reckoned from the date of arrival at the destination, or from the date on which the aircraft ought to have arrived, or from the date on which the carriage stopped.

#### ARTICLE 36

##### *Successive Carriage*

1. In the case of carriage to be performed by various successive carriers and falling within the definition set out in paragraph 3 of Article 1, each carrier which accepts passengers, baggage or cargo is subject to the rules set out in this Convention and is deemed to be one of the parties to the contract of carriage in so far as the contract deals with that part of the carriage which is performed under its supervision.
2. In the case of carriage of this nature, the passenger or any person entitled to compensation in respect of him or her can take action only against the carrier which performed the carriage during which the accident or the delay occurred, save in the case where, by express agreement, the first carrier has assumed liability for the whole journey.
3. As regards baggage or cargo, the passenger or consignor will have a right of action against the first carrier, and the passenger or consignee who is entitled to delivery will have a right of action against the last carrier, and further, each may take action against the carrier which performed the carriage during which the destruction, loss, damage or delay took place. These carriers will be jointly and severally liable to the passenger or to the consignor or consignee.

#### ARTICLE 37

##### *Right of Recourse against Third Parties*

Nothing in this Convention shall prejudice the question whether a person liable for damage in accordance with its provisions has a right of recourse against any other person.

#### CHAPTER IV

##### *Combined Carriage*

#### ARTICLE 38

##### *Combined Carriage*

1. In the case of combined carriage performed partly by air and partly by any other mode of carriage, the provisions of this Convention shall, subject to paragraph of Article 18, apply only to the carriage by air, provided that the carriage by air falls within the terms of Article 1.

2. Nothing in this Convention shall prevent the parties in the case of combine carriage from inserting in the document of air carriage conditions relating to other modes of carriage, provided that the provisions of this Convention are observed as regards the carriage by air.

## CHAPTER V

### *Carriage by Air Performed by a Person other than the Contracting Carrier*

#### ARTICLE 39

##### *Contracting Carrier - Actual Carrier*

The provisions of this Chapter apply when a person (hereinafter referred to as “the contracting carrier”) as a principal makes a contract of carriage governed by this Convention with a passenger or consignor or with a person acting on behalf of the passenger or consignor, and another person (hereinafter referred to as “the actual carrier”) performs, by virtue of authority from the contracting carrier, the whole or part of the carriage, but is not with respect to such part a successive carrier within the meaning of this Convention. Such authority shall be presumed in the absence of proof to the contrary.

#### ARTICLE 40

##### *Respective Liability of Contracting and Actual Carriers*

If an actual carrier performs the whole or part of carriage which, according to the contract referred to in Article 39, is governed by this Convention, both the contracting carrier and the actual carrier shall, except as otherwise provided in this Chapter, be subject to the rules of this Convention, the former for the whole of the carriage contemplated in the contract, the latter solely for the carriage which it performs.

#### ARTICLE 41

##### *Mutual Liability*

1. The acts and omissions of the actual carrier and of its servants and agents acting within the scope of their employment shall, in relation to the carriage performed by the actual carrier, be deemed to be also those of the contracting carrier.

2. The acts and omissions of the contracting carrier and of its servants and agents acting within the scope of their employment shall in relation to the carriage performed by the actual carrier, be deemed to be also those of the actual carrier. Nevertheless, no such act or omission shall subject the actual carrier to liability exceeding the amounts referred to in Articles 21, 22, 23 and 24. Any special agreement under which the contracting carrier assumes obligations not imposed by this Convention or any waiver

of rights or defences conferred by this Convention or any special declaration of interest in delivery at destination contemplated in Article 22 shall not affect the actual carrier unless agreed to by it.

#### ARTICLE 42

##### *Addressee of Complaints and Instructions*

Any complaint to be made or instruction to be given under this Convention to the carrier shall have the same effect whether addressed to the contracting carrier or to the actual carrier. Nevertheless, instructions referred to in Article 12 shall only be effective if addressed to the contracting carrier.

#### ARTICLE 43

##### *Servants and Agents*

In relation to the carriage performed by the actual carrier, any servant or agent of that carrier or of the contracting carrier shall, if they prove that they acted within the scope of their employment, be entitled to avail themselves of the conditions and limits of liability which are applicable under this Convention to the carrier whose servant or agent they are, unless it is proved that they acted in a manner that prevents the limits of liability from being invoked in accordance with this Convention.

#### ARTICLE 44

##### *Aggregation of Damages*

In relation to the carriage performed by the actual carrier, the aggregate of the amounts recoverable from that carrier and the contracting carrier, and from their servant and agents acting within the scope of their employment, shall not exceed the highest amount which could be awarded against either the contracting carrier or the actual carrier under this Convention, but none of the persons mentioned shall be liable for sum in excess of the limit applicable to that person.

#### ARTICLE 45

##### *Addressee of Claims*

In relation to the carriage performed by the actual carrier, an action for damage may be brought, at the option of the Plaintiff, against that carrier or the contracting carrier, or against both together or separately. If the action is brought against only one of those carriers, that carrier shall have the right to require the other carrier to be joiner in the proceedings, the procedure and effects being governed by the law of the court seized of the case.

#### ARTICLE 46

##### *Additional Jurisdiction*

Any action for damages contemplated in Article 45 must be brought, at the option of the Plaintiff, in the territory of one of the State Parties, either before a court in which an action may be brought against the

contracting carrier, as provided in Article 33, or before the court having jurisdiction at the place where the actual carrier has its domicile or its principal place of business.

#### ARTICLE 47

##### *Invalidity of Contractual Provisions*

Any contractual provision tending to relieve the contracting carrier or the actual carrier of liability under this Chapter or to fix a lower limit than that which is applicable according to this Chapter shall be null and void, but the nullity of any such provision does not involve the nullity of the whole contract, which shall remain subject to the provisions of this Chapter.

#### ARTICLE 48

##### *Mutual Relations of Contracting and Actual Carriers*

Except as provided in Article 45, nothing in this Chapter shall affect the rights and obligations of the carriers between themselves, including any right of recourse or indemnification.

#### CHAPTER VI

##### *Other Provisions*

#### ARTICLE 49

##### *Mandatory Application*

Any clause contained in the contract of carriage and all special agreements entered into before the damage occurred by which the parties purport to infringe the rules laid down by this Convention, whether by deciding the law to be applied, or by altering the rules as to jurisdiction, shall be null and void.

#### ARTICLE 50

##### *Insurance*

States Parties shall require their carriers to maintain adequate insurance covering their liability under this Convention. A carrier may be required by the State Party into which it operates to furnish evidence that it maintains adequate insurance covering its liability under this Convention.

#### ARTICLE 51

##### *Carriage Performed in Extraordinary Circumstances*

The provisions of Articles 3 to 5, 7 and 8 relating to the documentation of carriage shall not apply in the case of carriage performed in extraordinary circumstances outside the normal scope of a carrier's business.

## ARTICLE 52

### *Definition of Days*

The term “**days**” when used in this Convention means calendar days, not working days.

## CHAPTER VII

### *Final Clauses*

## ARTICLE 53

### *Signature, Ratification and Entry into Force*

- 1.** This Convention shall be open for signature in Montreal on 28 May, 1999 by States participating in the International Conference on Air Law held at Montreal from 10 to 28 May 1999. After 28 May 1999, the Convention shall be open to all States for signature at the Headquarters of the International Civil Aviation Organization in Montreal until it enters into force in accordance with paragraph 6 of this Article.
- 2.** This convention shall be open for signature by Regional Economic Integration Organizations. For the purpose of this Convention, a “Regional Economic Integration Organization” means any organization which is constituted by sovereign State of a given region which has competence in respect of certain matters governed by this convention and has been duly authorised to sign and to ratify, accept, approve or accede to this Convention. A reference to a “State Party” or “States Parties” in this Convention, otherwise than in paragraph 2 of Article 1, paragraph 1 (b) of Article 3, paragraph (b) of Article 5, Article 23, 33, 46, and paragraph (b) of Article 57, applies equally to a Regional Economic Integration Organization. For the purpose of Article 24, the references to “a majority of the States Parties” and “one-third of the States Parties” shall not apply to a Regional Economic Integration Organization.
- 3.** This Convention shall be subject to ratification by States and by Regional Economic Integration Organizations which have signed it.
- 4.** Any State or Regional Economic Integration Organization which does not sign this Convention may accept, approve or accede to it at any time.
- 5.** Instruments of ratification, acceptance, approval or accession shall be deposited with the International Civil Aviation Organization which is hereby designated the Depositary.
- 6.** This convention shall enter into force on the sixtieth day following the date of deposit of the thirtieth instrument of ratification, acceptance approval or accession with the Depositary between the States which have deposited such instrument. An instrument deposited by a Regional Economic International Organization shall not be counted for the purpose of this paragraph.
- 7.** For other States and for other Regional Economic Integrations, this Convention shall take effect sixty days following the date of deposit of the instrument of ratification acceptance, approval or accession.

**8.** The Depositary shall promptly notify all signatories and States Parties of-

- (a) each signature of this Convention and date thereof;
- (b) each deposit of an instrument of ratification acceptance, approval or accession and date thereof;
- (c) the date of entry into force of this Convention;
- (d) the date of the coming into force of any revision of the limits of liability under this Convention;
- (e) any denunciation under Article 54.

#### ARTICLE 54

##### *Denunciation*

- 1.** Any State Party may denounce this Convention by written notification to the Depositary.
- 2.** Denunciation shall take effect one hundred and eighty days following the date on which notification is received by the Depositary.

#### ARTICLE 55

##### *Relationship with State Parties over Warsaw Convention Instruments*

This Convention shall prevail over any rules which apply to international carriage, by air-

- (1) Between States Parties to this Convention by virtue of those States commonly being Party to-
  - (a) the *Convention for the Unification of Certain Rules Relating to International Carriage by Air* Signed in Warsaw on 12th October, 1929 (hereinafter called “the Warsaw Convention”);
  - (b) the *Protocol to Amend the Convention for the Unification of Certain Rules relating to International Carriage by Air* signed at Warsaw on 12th October. 1929, done at The Hague on 28 September, 1955 (hereinafter called The Hague Protocol”);
  - (c) the *Convention, supplementary to the Warsaw Convention, for the Unification of Certain Rules relating to International Carriage by Air performed by a person other than the Contracting Carrier*, signed at Guadalajara on 18th September, 1961 (hereinafter called “the Guadalajara Convention”);
  - (d) the *Protocol to Amend the Convention lot the Unification of Certain Rules Relating to International Carriage by Air* signed at Warsaw on 12th October. 1929 as Amended by the Protocol, (done at the Hague on 28th September, 1955) signed at Guatemala City on 8th March, 1971 (hereinafter called “the Guatemala City Protocol”);
  - (e) *Additional Protocol Nos. 1 to 3 and Montreal Protocol No. 4 to amend the Warsaw Convention as amended by The Hague Protocol or the Warsaw Convention as amended by both The Hague Protocol*

*and the Guatemala City Protocol signed at Montreal on 25th September, 1975 (hereinafter called “the Montreal Protocols”); or*

(2) Within the territory of any single State Party to this Convention by virtue of that State being Party to one or more of the instruments referred to in sub-paragraphs (a) to (e) above.

#### ARTICLE 56

##### *States with more than one System of Law*

1. If a State has two or more territorial units in which different systems of law are applicable in relation to matters dealt with in this Convention, it may at the time of signature, ratification, acceptance, approval or accession declare that this Convention shall extend to all its territorial units or only to one or more of them and may notify this declaration by submitting another declaration at any time.

2. Any such declaration shall be notified to the Depository and shall state expressly the territorial units to which the Convention applies.

3. In relation to a State Party which has made such a declaration-

(a) reference in Article 23 to “national currency” shall be construed as referring to the currency of the relevant territorial unit of that State; and

(b) the reference in Article 28 to “national law” shall be construed as referring to the law of the relevant territorial unit of that State.

#### ARTICLE 57

##### *Reservations*

No reservation may be made to this convention except that a State Party may at any time declare by a notification addressed to the Depository that this Convention shall not apply to-

(a) international carriage by air performed and operated directly by that State Party for non-commercial purposes in respect to its functions and duties as a sovereign State; and/or

(b) the carriage of persons, cargo and baggage for its military authorities on aircraft registered in or leased by that State Party, the whole capacity of which has been reserved by or on behalf of such authorities.

IN WITNESS WHEREOF the undersigned plenipotentiaries having been duly authorized, have signed this Convention.

DONE at Montreal on the 28th day of May of the year one thousand nine hundred and ninety-nine in the English, Arabic, Chinese, French, Russian and Spanish languages, all texts being equally authentic. This Convention shall remain deposited in the archives of the international Civil Aviation Organization. and certified topics thereof shall be transmitted by the Depository to all States Parties to this



Convention, as well as to all States Parties to the Warsaw Convention, the Hague Protocol, the Guadalajara Convention. The Guatemala City protocol, and the Montreal Protocols.

---

### THIRD SCHEDULE

[Section 48 (2).]

*Modifications to the Convention for the Unification of Certain rules relating to  
International Carriage by Air*

#### CHAPTER 1

##### *General Provisions*

#### ARTICLE 1

##### *Scope of Application*

- 1.** This Convention applies to all carriage of persons, baggage or cargo performed by aircraft for reward within Nigeria. It applies equally to gratuitous carriage by aircraft performed by an air transport undertaking.
- 2.** Carriage to be performed by several successive carriers is deemed for the purposes of this Convention, to be one undivided carriage if it has been regarded by the parties as a single operation, whether it had been agreed upon under the form of a single contract or of a series of contracts.
- 3.** This Convention applies also to carriage as set out in Chapter V, subject to the terms contained therein.

#### ARTICLE 2

##### *Carriage Performed by State and Carriage of Postal Items*

- 1.** This Convention applies to carriage performed by the State or by legally constituted public bodies provided it falls within the conditions laid down in Article 1.
- 2.** In the carriage of postal items, the carrier shall be liable only to the relevant postal administration in accordance with the rules applicable to the relationship between the carriers and the postal administrations.
- 3.** Except as provided in paragraph 2 of this Article, the provisions of this Convention shall not apply to the carriage of postal items.

## CHAPTER II

### *Documentation and Duties of the Parties relating to the Carriage of Passengers*

#### *Baggage and Cargo*

### ARTICLE 3

#### *Passengers and Baggage*

1. In respect of carriage of passengers, an individual or collective document carriage shall be delivered containing an indication of the places of departure and destination.
2. Any other means which preserves the information indicated in paragraph 1 may be substituted for the delivery of the document referred to in that paragraph. If any such other means is used, the carrier shall offer to deliver to the passenger written statement of the information so preserved.
3. The carrier shall deliver to the passenger a baggage identification tag for each piece of checked baggage.
4. The passenger shall be given written notice to the effect that where this Convention is applicable it governs and may limit the liability of carriers in respect of death or injury and for destruction or loss of, or damage to, baggage and for delay.
5. Non-compliance with the provisions of the foregoing paragraphs shall not affect the existence or the validity of the contract of carriage, which shall nonetheless be subject to the rules of this Convention including those relating to limitation of liability.

### ARTICLE 4

#### *Cargo*

1. In respect of the carriage of cargo, an air waybill shall be delivered.
2. Any other means which preserves a record of the carriage to be performed may be substituted for the delivery of an air waybill. If such other means are used, the carrier shall, if so requested by the consignor, deliver to the consignor a cargo receipt permitting identification of the consignment and access to the information contained in the record preserved by such other means.

### ARTICLE 5

#### *Contents of Air Waybill of Cargo Receipt*

The air waybill or the cargo receipt shall include-

- (a) an indication of the places of departure and destination;

(b) an indication of the weight of the consignment.

#### ARTICLE 6

##### *Document Relating to the Nature of the Cargo*

The consignor may be required, if necessary to meet the formalities of customs, police, and similar public authorities, to deliver a document indicating the nature of the cargo. This provision creates for the carrier no duty, obligation or liability resulting therefrom.

#### ARTICLE 7

##### *Description of Air Waybill*

1. The air waybill shall be made out by the consignor in three original parts.
2. The first part shall be marked "for the carrier"; it shall be signed by the consignor. The second part shall be marked "for the consignee," it shall be signed by the consignor and by the carrier. The third part shall be signed by the carrier who shall hand it to the consignor after the cargo has been accepted.
3. The signature of the carrier and that of the consignor may be printed or stamped.
4. If, at the request of the consignor, the carrier makes out the air waybill, the carrier shall be deemed, subject to proof to the contrary, to have done so on behalf of the consignor.

#### ARTICLE 8

##### *Documentation for Multiple Packages*

When there is more than one package-

- (a) the carrier of cargo has the right to require the consignor to make out separate air waybills;
- (b) the consignor has the right to require the carrier to deliver separate cargo receipt when the other means referred to in paragraph 2 of Article 4 are used.

#### ARTICLE 9

##### *Non-compliance with Documentary Requirements*

Non-compliance with the provisions of Articles 4 to 8 shall not affect the existence or the validity of the contract of carriage, which shall nonetheless, be subject to the rules of this Convention including those relating to limitation of liability.

#### ARTICLE 10

##### *Responsibility for Particulars of Documentation*

1. The consignor is responsible for the correctness of the particulars and statements relating to the cargo inserted by it or on its behalf in the air waybill or furnished by it or on its behalf to the carrier for insertion in the cargo receipt or for insertion in the record preserved by the other means referred to in paragraph 2 of Article 4. The foregoing shall also apply where the person acting on behalf of the consignor is also the agent of the carrier.
2. The consignor shall indemnify the carrier against all damage suffered by it, or by any other person to whom the carrier is liable, by reason of the irregularity, incorrectness or incompleteness of the particulars and statements furnished by the consignor or on its behalf.
3. Subject to the provisions of paragraphs 1 and 2 of this Article, the carrier shall indemnify the consignor against all damages suffered by it, or by any other person to whom the consignor is liable by reason of irregularity, incorrectness or incompleteness of the particulars and statements inserted by the carrier on its behalf in the cargo receipt or in the record preserved by the other means referred to in paragraph 2 of Article 4.

## ARTICLE 11

### *Evidentiary Value of Documentation*

1. The air waybill or the cargo receipt is *prima facie* evidence of the conclusion of the contract, of the acceptance of the cargo and of the conditions of carriage mentioned therein.
2. Any statements in the air waybill or the cargo receipt relating to the weights, dimensions and packaging of the cargo, as well as those relating to the number of packages, are *prima facie* evidence of the facts stated; those relating to the quantity, volume and condition of the cargo do not constitute evidence against the carrier except so far as they both have been, and are stated in the air waybill or the cargo receipt to have been, checked by it in the presence of the consignor, or relate to the apparent condition of the cargo.

## ARTICLE 12

### *Right of Disposition of Cargo*

1. Subject to its liability to carry out all its obligations under the contract of carriage, the consignor has the right to dispose of the cargo by withdrawing it at the airport of departure or destination, or by stopping it in the course of the journey on any landing, or by calling for it to be delivered at the place of destination or in the course of the journey to a person other than the consignee originally designated, or by requiring it to be returned to the airport of departure. The consignor must not exercise this right of disposition in such a way as to prejudice the carrier or other consignors and must reimburse any expenses occasioned by the exercise of this right.
2. If it is impossible to carry out the instructions of the consignor, the carrier must so inform the consignor forthwith.

**3.** If the carrier carries out the instructions of the consignor for the disposition of the cargo without requiring the production of the part of air waybill or the cargo receipt delivered to the latter, the carrier will be liable without prejudice to its right of recovery from the consignor, for any damage which may be caused thereby to any person who is lawfully in possession of that part of air waybill or the cargo receipt.

**4.** The right conferred on the consignor ceases at the moment when that of the consignee begins in accordance with Article 13. Nevertheless, if the consignee declines to accept the cargo, or cannot be communicated with the consignor resumes its right to disposition.

#### ARTICLE 13

##### *Delivery of the Cargo*

**1.** Except when the consignor has exercised its right under Article 12, the consignee is entitled, on arrival of the cargo at the place of destination, to require the carrier to deliver the cargo to it, on payment of the charges due on complying with the conditions of carriage.

**2.** Unless it is otherwise agreed, it is the duty of the carrier to give notice to the consignee as soon as the cargo arrives.

**3.** If the carrier admits the loss of the cargo, or if the cargo has not arrived at the expiration of two days after the date on which it ought to have arrived, the consignee is entitled to enforce against the carrier the rights which flow from the contract of carriage.

#### ARTICLE 14

##### *Enforcement of the Rights of Consignor and Consignee*

The consignor and the consignee can respectively enforce all the rights given to them by Articles 12 and 13, each in its own name, whether it is acting in its own interest or in the interest of another, provided that it carries out the obligations imposed by the contract of carriage.

#### ARTICLE 15

##### *Relations of Consignor and Consignee or Mutual Relations of Third Parties*

**1.** Articles 12, 13 and 14 do not affect either the relations of the consignor and the consignee with each other or the mutual relations of third parties whose rights are derived either from the consignor or from the consignee.

**2.** The provisions of Articles 12, 13, and 14 can only be varied by express provisions in the air waybill or the cargo receipt.

#### ARTICLE 16

##### *Formalities of Customs, Police or Other Public Authorities*

1. The Consignor must furnish such information and such documents as are necessary to meet the formalities of customs, police, and any other public authorities before the cargo can be delivered to the consignee. The consignor is liable to the carrier for any damage occasioned by the absence, insufficiency or irregularity of any such information or documents, unless the damage is due to the fault of the carrier, its servants or agents.

2. The carrier is under no obligation to enquire into the correctness or sufficiency of such information or documents.

### CHAPTER III

#### *Liability of the Carrier and Extension Compensation for Damage*

#### ARTICLE 17

##### *Death and Injury of Passengers*

##### *Damage to Baggage*

1. The carrier is liable for damage sustained in case of death or bodily injury of a passenger upon condition only that the accident which caused the death or injury took place on board the aircraft or in the course of any of the operations of embarking, disembarking.

The carrier is liable for damage sustained in case of destruction or loss of, (damage to checked baggage upon condition only that the event which caused the destruction, or loss or damage took place on board the aircraft or during any period within which the checked baggage was in the charge of the carrier. However, the carrier is not liable if and to the extent that the damage resulted from the inherent defect quality or vice of the baggage. In the case of unchecked baggage, including personal items, the carrier is liable if the damage resulted from its fault or that of its servants or agents.

If the carrier admits the loss of the checked baggage, or if the checked baggage has not arrived at the expiration of seven day (after the date on which it ought to have arrived, the passenger is entitled to enforce against the carrier the rights which flow from the contract of carriage.

Unless otherwise specified, in this Convention the term “**baggage**” means both checked baggage and unchecked baggage.

#### ARTICLE 18

##### *Damage of Cargo*

The carrier is liable for damage sustained in the event of the destruction or loss of, or damage to, cargo upon condition only that the event which caused the damage so sustained took place during the carriage by air.

However, the carrier is not liable if and to the extent it proves that the destruction or loss of, or damage to, the cargo resulted from one or more of the following:

inherent defect, quality or vice of that cargo;

defective packing of that cargo performed by a person other than the carrier or its servants or agents;

an act of war or an armed conflict;

an act of public authority carried out in connection with the entry, exit or transit of the cargo.

The carriage by air within the meaning paragraph 1 of this Article comprises the period during which the cargo is in the charge of the carrier.

The period of the carriage by air does not extend to any carriage by land, by sea or by inland waterway performed outside an airport. If however, such carriage takes place in the performance of a contract (or carriage by air, for the purpose of loading, delivery or transshipment, any damage is presumed, subject to proof to the contrary, to have been the result of an event which took place during the carriage by air. If a carrier, without consent or the consignor, substitutes carriage by another mode of transport for the whole or part of a carriage intended by the agreement between the parties to be carried by air, such carriage by another mode of transport is deemed to be within the period of carriage by air.

#### ARTICLE 19

##### *Delay*

The carrier is liable for damage occasioned by delay in the carriage by air of passengers, baggage or cargo. Nevertheless, the carrier shall not be liable for damage occasioned by delay if it proves that it and its servants and agents took all measures that could reasonably be required to avoid the damage or that it was impossible for it or them to take such measures.

#### ARTICLE 20

##### *Exoneration*

If the carrier proves that the damage was caused or contributed to by the negligence or other wrongful act or omission of the person claiming compensation, or the person from which he or she derives his or her rights, the carrier shall be wholly or partly exonerated from its liability to the claimant to the extent that such negligence or wrongful act or omission caused or contributed to the damage. When by reason of death or injury of a passenger compensation is claimed by a person other than the passenger, the carrier shall likewise be wholly or partly exonerated from its liability to the extent that it proves that the damage was caused or contributed to by the negligence or other wrongful act or omission of that passenger. This Article applies to all the liability provisions (in this Convention, including paragraph 1 of Article 21.

#### ARTICLE 21

##### *Compensation in case of Death or Injury of Passengers*

For damages arising under paragraph 1 of Article 17 not exceeding 100,000.00 United States Dollars for each passenger, the carrier shall not be able to exclude or limit its liability.

The carrier shall not be liable for damages arising under paragraph 1 of Article 17 to the extent that they exceed for each passenger 100,000 United States dollars if the carrier proves that-

such damage was not due to the negligence or other wrongful act or omission of the carrier or its servants or agents; or

such damage was solely due to the negligence or other wrongful act or omission of a third party.

## ARTICLE 22

### *Limits of Liability in relation to Delay, Baggage and Cargo*

1. In the case of damage caused by delay as specified in Article 19 in the carriage of persons, the liability of the carrier for each passenger is limited to 4150 United States Dollars.
2. In the carriage of baggage, the liability of the carrier in the case of destruction, loss, damage, or delay is limited to 1000 United States Dollars for each passenger unless the passenger has made, at the time when the checked baggage was handed over to the carrier, a special declaration of interest in delivery at destination and has paid a supplementary sum if the case so requires. In that case the carrier will be liable to pay a sum not exceeding the declared sum, unless it proves that the sum is greater than the passenger's actual interest in delivery at destination.
3. In the carriage of cargo, the liability of the carrier in the case of destruction damage or delay is limited to a sum of 20 United States Dollars per kilogram, unless the consignor has made, at the time when the package was handed over to the carrier a special declaration of interest in delivery at a destination and has paid a supplementary sum if the case so requires. In that case the carrier will be liable to pay a sum exceeding the declared sum, unless it proves that the sum is greater than the consignor's actual interest in delivery at destination.
4. In the case of destruction, loss, damage or delay of part of the cargo, or any object contained therein, the weight to be taken into consideration in determining amount to which the carrier's liability is limited shall be only the total weight of package or packages concerned, Nevertheless, when the destruction, loss, damage part of the cargo, or of an object contained therein, affects the value of other packages covered by the same air waybill, or the same receipt or, if they were not issued, by same record preserved by the other means referred to in paragraph 2 of Article 4 total weight of such package or packages shall also be taken into consideration determining the limit of liability.
5. The foregoing provisions of paragraph 1 and 2 of this Article shall not apply if it is proved that the damage resulted from an act or omission of the carrier, its servants or agents, done with intent to cause damage or recklessly and with knowledge damage would probably result; provided that, in the case of such act or omission servant or agent, it is also proved that such servant or agent was acting within scope of its employment.



6. The limits prescribed in Article 21 and in this Article shall not prevent the court from awarding, in accordance with its own rules of procedure in addition, the whole part of the court costs and of the other expenses of the litigation incurred by Plaintiff, including interest. The foregoing provision shall not apply if the amount of damages awarded, including court costs and other expenses of the litigation, does not exceed the sum which the carrier has offered in writing to the plaintiff within a period of six months from the date of the occurrence causing the damage, or before the commencement of the action if that is later.

#### ARTICLE 23

##### *Conversion of Monetary Units*

The sums mentioned in Articles 21 and 22 shall be converted to Naira at the existing official exchange rate.

#### ARTICLE 24

##### *Review of Limits*

Without prejudice to the provisions of Article 25 of this Convention the limits liability prescribed in Articles 21, 22 and 23 shall be reviewed by the Minister of Aviation upon advice by the Nigerian Civil Aviation Authority at seven year intervals, the first such review to take place at the end of the seventh year following the date of entry in force of this Act.

#### ARTICLE 25

##### *Stipulation on Limits*

A carrier may stipulate that the contract of carriage shall be subject to higher limits of liability than those provided for in this Convention or to no limits of liability whatsoever.

#### ARTICLE 26

##### *Invalidity of Contractual Provisions*

Any provision tending to relieve the carrier of liability or to fix a lower limit than that which is laid down in this Convention shall be null and void, but the nullity of any such provision does not involve the nullity of the whole contract, which shall remain subject to the provisions of this Convention.

#### ARTICLE 27

##### *Freedom to Contract*

Nothing contained in this Convention shall prevent the carrier from refusing to enter into any contract of carriage, from waiving any defences available under the Convention, or from laying down conditions which do not conflict with the provisions of this Convention.

## ARTICLE 28

### *Advance Payments*

In the case of aircraft accidents resulting in death or injury of passengers, the carrier shall, make advance payments without delay to a natural person or persons who are entitled to claim compensation in order to meet the immediate economic needs of such persons. Such advance payment amount shall not constitute a recognition of liability and may be offset against any amounts subsequently paid as damages by the carrier.

## ARTICLE 29

### *Basis of Claims*

In the carriage of passengers, baggage and cargo, any action for damages, however founded, whether under this Convention or in contract or in tort or otherwise can only be brought subject to the conditions and such limits of liability as are set out in this Convention without prejudice to the question as to who are the persons who have the right to bring suit and what are their respective rights. In any such action, punitive, exemplary orally other non-compensatory damages shall not be recoverable.

## ARTICLE 30

### *Servants, Agents - Aggregation of Claims*

1. If an action is brought against a servant or agent of the carrier arising out of damage to which the Convention relates, such servant or agent, if they prove that they acted within the scope of their employment shall be entitled to avail themselves of the conditions and limits of liability which the carrier itself is entitled to invoke under this Convention.
2. The aggregate of the amounts recoverable from the carrier, its servants and agents, in that case, shall not exceed the said limits.
3. Save in respect of the carriage of cargo the provisions of paragraphs 1 and 2 of this Article shall not apply if it is proved that the damage resulted from an act or omission of the servant or agent done with intent to cause damage or recklessly and with knowledge that damage would probably result.

## ARTICLE 31

### *Timely Notice of Complaints*

1. Receipt by the person entitled to delivery of checked baggage or cargo without complaint is prima facie evidence that the same has been delivered in good condition and in accordance with the document of carriage or with the record preserved by the other means referred to in paragraph 2 of Article 3 and paragraph 2 of Article 4.
2. In the case of damage, the person entitled to delivery must complain to the carrier forthwith after the discovery of the damage, and, at the latest, within two days from the date of receipt in the case of

checked baggage and seven days from the date of receipt in the case of cargo. In the case of delay, the complaint must be made at the latest within fourteen days from the date on which the baggage or cargo have been placed at his or her disposal.

Every complaint must be made in writing and given or dispatched within times aforesaid.

If no complaint is made within the times aforesaid, no action shall lie against the carrier, save in the case of fraud on its part.

## ARTICLE 32

### *Death of Person Liable*

In the case of the death of the person liable, an action for damages lies in accord with the terms of this Convention against those legally representing his or her estate.

## ARTICLE 33

### *Jurisdiction*

1. An action for damages must be brought, at the option of the Plaintiff, in the territory of one of the States Parties, either before the court of the domicile of the carrier or of its principal place of business or where it has a place of business through which the contract has been made or before the court at the place of destination.

2. In respect of damage resulting from the death or injury of a passenger, an action may be brought before one of the courts mentioned in paragraph 1 of this Article, either in the territory of a State Party in which at the time of the accident the passenger has his or her principal and permanent residence and to or from which the carrier operates services for carriage of passengers by air, either on its own aircraft, or on another carrier's aircraft pursuant to a commercial agreement, and in which that carrier conducts its business of carriage of passengers by air from premises leased or owned by the carrier itself or by another carrier with which it has a commercial agreement.

3. For the purpose of paragraph 2-

(a) "**commercial agreement**" means an agreement, other than an agency agreement, made between carriers and relating to the provision of their joint services for carriage of passengers by air;

(b) "**principal and permanent residence**" means the one fixed and permanent abode of the passenger at the time of the accident. The nationality of the passenger shall not be the determining factor in this regard.

4. Questions of procedure shall be governed by the law of the court seized of the case.

## ARTICLE 34

### *Arbitration*

1. Subject to the provisions of this Article the parties to the contract of carriage for cargo may stipulate that any dispute relating to the liability of the carrier under the Convention shall be settled by arbitration. Such agreement shall be in writing.
2. The arbitrator or arbitration tribunal shall apply the provisions of this Convention.
3. The provisions of paragraph 2 of this Article shall be deemed to be part of every arbitration clause or agreement, and any term of such clause or agreement which is inconsistent therewith shall be null and void.

### ARTICLE 35

#### *Limitation of Actions*

The right to damages shall be extinguished if an action is not brought within period of two years, reckoned from the date of arrival at the destination, or from the date on which the aircraft ought to have arrived, or from the date on which the carriage stopped.

### ARTICLE 36

#### *Successive Carriage*

1. In the case of carriage to be performed by various successive carriers and falling within the definition set out in paragraph 3 of Article 1, each carrier which accepts passengers, baggage or cargo is subject to the rules set out in this Convention and is deemed to be one of the parties to the contract of carriage in so far as the contract deals with that part of the carriage which is performed under its supervision.
2. In the case of carriage of this nature, the passenger or any person entitled to compensation in respect of him or her can take action only against the carrier which performed the carriage during which the accident or the delay occurred, save in the case where, by express agreement, the first carrier has assumed liability for the whole journey.
3. As regards baggage or cargo, the passenger or consignor will have a right of action against the first carrier, and the passenger or consignee who is entitled to delivery will have a right of action against the last carrier, and further, each may take action against the carrier which performed the carriage during which the destruction, loss, damage or delay took place. These carriers will be jointly and severally liable to the passengers or to the consignor or consignee.

### ARTICLE 37

#### *Right to Resources against Third Parties*

Nothing in this Convention shall prejudice the question whether a person liable for damage in accordance with its provisions has a right of resources against any other person.

## CHAPTER IV

### ARTICLE 38

#### *Combined Carriage*

1. In the case of combined carriage performed partly by air and partly by other mode of carriage, the provisions of this Convention shall subject to paragraph 4 of Article 18, apply only to the carriage by air provided that the carriage by air within the terms of Article 1.
2. Nothing in this convention shall prevent the parties in the case of combined carriage from inserting in the documents of air carriage conditions relating to other modes of carriage, provided that the provisions of this convention are observed as regards the carriage by air.

## CHAPTER V

#### *Carriage by Air Performed by a Person other than the Contracting Carrier*

### ARTICLE 39

#### *Contracting Carrier - Actual Carrier*

The provisions of this Chapter apply when a person thereafter referred to as the contracting carrier as a principal makes a contract of carriage governed by this convention with a passenger or consignor or with a person acting on behalf of the passenger or consignor, and another thereafter referred to as "the actual carrier" performs, by virtue of authority from the contracting carrier the whole or part of the carriage, but is not with respect to such part a successive carrier within the meaning of this Convention. Such authority shall be presumed in the absence of proof to the contrary.

### ARTICLE 40

#### *Respective Liability of Contracting and Actual Carriers*

If an actual carrier performs the whole or part of carriage which, according to the contract referred to in Article 39, is governed by this Convention, both the contracting carrier and the actual shall, except as otherwise provided in this chapter be subject to the rules of this convention, the former for the whole of the carriage contemplated in the contract, the latter solely for the carriage which it performs.

### ARTICLE 41

#### *Mutual Liability*

1. The acts and omissions of the actual carrier and of its servants and agents acting within the scope of their employment shall, in relation to the carriage performed by the actual carrier, be deemed to be also those of the contracting carrier.

2. The acts and omissions of the contracting carrier and of its servants and agents acting within the scope of their employment shall in relation the carriage performed by the actual carrier, be deemed to be also those of the actual carrier. Nevertheless, no such act or omission shall subject the actual carrier to liability exceeding the amounts referred to in Articles 21, 22, 23 and 24. Any special agreement under which the contracting carrier assumes obligations not imposed by this convention or any waiver of rights or defences conferred by this Convention or any special declaration of interest in delivery at destination contemplated in Article 22 shall not affect the actual carrier unless agreed to by it.

#### ARTICLE 42

##### *Addressee of Complaints and Instruments*

Any complaint to be made or instruction to be given under this Convention to carrier shall have the same effect whether addressed to the contracting carrier or to actual carrier. Nevertheless, instructions referred to in Article 12 shall only be active if addressed to the contracting carrier.

#### ARTICLE 43

##### *Servants and Agents*

In relation to the carriage performed by the actual carrier any servant or agent of carrier or of the contracting carrier shall, if they prove that they acted within the scope of their employment, be entitled to avail themselves of the conditions and limits of liability which are applicable under this Convention to the carrier whose servant or agent they are, unless it is proved that they acted in a manner that prevents the limits of liability from being invoked in accordance with this Convention.

#### ARTICLE 44

##### *Aggregation of Damages*

In relation to the carriage performed by the actual carrier, the aggregate amounts recoverable from that carrier and the contracting carrier and from theirs and agents acting within the scope of their employment, shall not exceed the highest amount which could be awarded against either the contracting carrier or the actual carrier under this Convention, but none of the persons mentioned shall be liable for a sum in excess of the limit applicable to that person.

#### ARTICLE 45

##### *Addressee of Claims*

In relation to the carriage performed by the actual carrier, an action for damages may be brought, at the option of the Plaintiff, against that carrier or the contracting carrier; or against both together or separately. If the action is brought against only one of those carriers, that carrier shall have the right to require the other carrier to be joined in the proceedings, the procedure and effects being governed by the law of the court seized of the case.

## ARTICLE 46

### *Invalidity of Contractual Provisions*

Any contractual provision tending to relieve the contracting carrier or the actual carrier of liability under this Chapter or to fix a lower limit than that which is applicable according to this Chapter shall be null and void, but the nullity of any such provision does not involve the nullity of the whole contract, which shall remain subject to the provisions of this Chapter.

## ARTICLE 47

### *Mutual Relations of Contracting and Actual Carrier*

Except as provided in Article 45, nothing in this Chapter shall affect the rights and obligations of the carriers between themselves, including any right of recourse or indemnification.

## CHAPTER VI

### *Other Provisions*

## ARTICLE 48

### *Mandatory Application*

Any clause contained in the contract or carriage and all special agreement entered into before the damage occurred by which the parties purport to infringe the rules laid down by this Convention, whether by deciding the law to be applied, or by altering the rules as to jurisdiction, shall be null and void.

## ARTICLE 49

### *Carriage Performed in Extraordinary Circumstances*

The provisions of Article 3 to 5, 7 and 8 relating to the documents of carriage shall not apply in the case of carriage performed in extra-ordinary circumstances outside the normal scope of a carrier's business.

## ARTICLE 50

### *Definition of Days*

The expression "**days**" when used in this Convention means working days, not calendar days.

---

## FOURTH SCHEDULE

[Section 73(1).]

Signed at Geneva, on 19 June, 1948

WHEREAS the International Civil Aviation Conference, held at Chicago November-December 1944, recommended the early adoption of a Convention dealing with the transfer of title to aircraft.

WHEREAS it is highly desirable in the interest of the future expansion of International Civil Aviation that rights in aircraft be recognized internationally,

THE UNDERSIGNED, duly authorised, have agreed, on behalf of their respective Government, as follows:

#### ARTICLE 1

1. The Contracting States undertake to recognise-

- (a) rights of property in aircraft;
- (b) rights to acquire aircraft by purchase coupled with possession of the aircraft;
- (c) rights to possession of aircraft under leases of six months or more;
- (d) mortgages, hypothèques and similar rights in aircraft which are contractually created as security for payment of an indebtedness;

Provided that such rights-

- (i) have been constituted in accordance with the law of the Contracting State in which the aircraft was registered as to nationality at the time of their constitution, and
- (ii) are regularly recorded in a public record of the Contracting State in which the aircraft is registered as to nationality.

The regularity of successive recordings in different Contracting States shall be determined in accordance with the law of the state where the aircraft was registered as to nationality at the time of each recording.

2. Nothing in this Convention shall prevent the recognition of any rights in aircraft under the law of any Contracting State; but Contracting States shall not admit or recognise any right as taking priority over the rights mentioned in paragraph 1 of this Article.

#### ARTICLE II

1. All recordings relating to a given aircraft must appear in the same record.

2. Except as otherwise provided in this Convention, the effects of the recording of any right mentioned in Article 1, paragraph 1, with regard to third parties shall be determined according to the law of the Contracting State where it is recorded.



**3.** A Contracting State may prohibit the recording of any right which cannot validly be constituted according to its national law.

#### ARTICLE III

**1.** The address of the authority responsible for maintaining the record must be shown on every aircraft's certificate of registration as to nationality.

**2.** Any person shall be entitled to receive from the authority duly certified copies or extracts of the particulars recorded. Such copies or extracts shall constitute *prime facie* evidence of the contents of the record.

**3.** If the law of a Contracting State provides that the filing of a document for recording shall have the same effect as the recording, it shall have the same effect for the purposes of this Convention. In that case, adequate provision shall be made to ensure that such document is open to the public.

**4.** Reasonable charges may be made for services performed by the authority maintaining the record.

#### ARTICLE IV

**1.** In the event that any claims in respect of compensation due for salvage of the aircraft, or extraordinary expenses indispensable for the preservation of the aircraft, give rise, under the law of the Contracting State where the operations of salvage or preservation were terminated, to a right conferring a charge against the aircraft, such right shall be recognised by Contracting States and shall take priority over all other rights in the aircraft.

**2.** The rights enumerated in paragraph 1 shall be satisfied in the inverse order of the dates of the incidents in connection with which they have arisen.

**3.** Any of the said rights may, within three months from the date of the termination of the salvage or preservation operations, be noted on the record.

**4.** The said rights shall not be recognised in other Contracting States after expiration of the three months mentioned in paragraph 3 unless, within this period,

(a) the right has been noted on the record in conformity with paragraph 3, and

(b) the amount has been agreed upon or judicial action on the right has been commenced.

As far as judicial action is concerned, the law of the forum shall determine the contingencies upon which the three months period may be interrupted or suspended.

**5.** This Article shall apply notwithstanding the provisions of Article 1, paragraph 2.

#### ARTICLE V

The priority of a right mentioned in Article 1, paragraph 1(d) extends to all sums thereby secured. However, the amount of interest included shall not exceed that accrued during the three years prior to the execution proceedings together with that accrued during the execution proceedings.

#### ARTICLE VI

In case of attachment or sale of an aircraft in execution, or of any right therein, the Contracting States shall not be obliged to recognise, as against the attaching or executing creditor or against purchaser, any right mentioned in Article 1, or the transfer of any such right, if constituted or effected with knowledge of the sale or execution proceedings by the person against whom the proceedings are directed.

#### ARTICLE VII

**1.** The proceedings of a sale of an aircraft in execution shall be determined by the law of the Contracting State where the sale takes place.

**2.** The following provisions shall however be observed-

(a) The date and place of the sale shall be fixed at least six weeks in advance

(b) The executing creditor shall supply to the Court or other competent authority a certified extract of the recordings concerning the aircraft. He shall give public notice of sale at the place where the aircraft is registered as to nationality in accordance with the law there applicable, at least one month before the day fixed and shall concurrently notify by registered letter, if possible by air mail, the recorded owner and the holders of recorded rights in the aircraft and of rights noted on record under Article IV, paragraph 3, according to their addresses as shown on record.

**3.** The consequences of failure to observe the requirements of paragraph 2 shall be as provided by the law of the Contracting State where the sale takes place. However any sale taking place in contravention of the requirements of that paragraph may be annulled upon demand made within six months from the date of the sale by any person suffering damage as the result of such contravention.

**4.** No sale in execution can be effected unless all rights having priority over to claim of the executing creditor in accordance with this Convention which are established before the competent authority are covered by the proceeds of sale or assumed by the purchaser.

**5.** When injury or damage is caused to persons or property on the surface of the Contracting State where the execution sale takes place, by any aircraft subject to any right referred to in Article 1, held as security for an indebtedness, unless adequate and effective insurance by a State or an insurance undertaking in any State has been provided by or on behalf of the operator to cover such injury or damage, the national law of such Contracting State may provide in case of the seizure of such aircraft or any other aircraft owned by the same person and encumbered with any similar right held by the same creditor-

(a) that the provisions of paragraph 4 above shall have no effect with regard to the person suffering such injury or damage or his representative if he is an executing creditor;

(b) that any right referred to in Article 1 held as security for an indebtedness encumbering the aircraft may not be set up against any person suffering such injury or damage or his representatives in excess of an amount equal to 80% of the sale price.

In the absence of other limit established by the law of the Contracting State where the execution sale takes place, the insurance shall be considered adequate within the meaning of present paragraph if the amount of the insurance corresponds to the value when new of the aircraft seized in execution.

**6.** Costs legally chargeable under the law of the Contracting State where the sale takes place, which are incurred in the common interest of creditors in the course of execution proceedings leading to sale, shall be paid out of the proceeds of sale before any claims, including those given preference by Article IV.

#### ARTICLE VIII

Sale of an aircraft in execution in conformity with the provisions of Article VII shall effect the transfer of the property in such aircraft free from all rights which are not assumed by the purchaser.

#### ARTICLE IX

Except in a case of a sale in execution in conformity with the provisions of Article VII, no transfer of an aircraft from the nationality register or the record of a Contracting State to that of another Contracting State shall be made unless, all holders of record rights have been satisfied or consent to the transfer.

#### ARTICLE X

**1.** If a recorded right in an aircraft of the nature specified in Article 1, and held as security for the payment of an indebtedness, extends, in conformity with the law of the Contracting State where the aircraft is registered, to spare parts stored in a specified place or places, such right shall be recognized by all Contracting States as long as the spare parts remain in the place or places specified provided that an appropriate public notice, specifying the description of the right, the name and address of the holder of this right and the record in which such right is recorded, is exhibited at the place where the spare parts are located, so as to give due notification to third parties that such spare parts are encumbered.

**2.** A statement indicating the character and the approximate number of such spare parts shall be annexed to or included in the recorded document. Such parts may be replaced by similar parts without affecting the right of the creditor.

**3.** The provisions of Article VII, paragraphs 1 and 4, and of Article VIII shall apply to the sale of spare parts in execution. However, where the executing creditor is an unsecured creditor, paragraph 4 of Article VII in its application to such a sale shall be construed so as to permit the sale to take place if a bid is received in an amount not less than two-thirds of the value of the spare parts as determined by experts appointed by the authority responsible for the sale. Further in the distribution of the proceeds

of sale, the competent authority may, in order to provide for the claim of the executing creditor, limit the amount payable to holders of prior rights to two thirds of such proceeds of sale after payment of the costs referred to in Article VII, paragraph 6.

4. For the purpose of this Article, the term “**spare parts**” means part of aircraft, engines, propellers, radio apparatus, instruments, appliances, furnishings, parts of any of the foregoing, and generally any other articles of whatever description maintained for installation in aircraft in substitution for parts or articles removed.

#### ARTICLE XI

1. The provisions of this Convention shall in each Contracting State apply to all aircraft registered as to nationality in another Contracting State.

2. Each contracting State shall also apply to aircraft registered as to nationality -

(a) the provisions of Articles II, III, IX and;

(b) the provisions of Article IV, unless the salvage or preservation operation have been terminated within its own territory.

#### ARTICLE XII

Nothing in this Convention shall prejudice the right of any Contracting State to enforce against an aircraft its national laws relating to immigration, customs or air navigation.

#### ARTICLE XIII

This convention shall not apply to aircraft used in military, customs or police services.

#### ARTICLE XIV

For the purpose of this Convention the competent judicial and administrative authorities of the contracting States may, subject to any contrary provision in the national law, correspond directly with each other.

#### ARTICLE XV

The contracting States shall take such measures as are necessary for the fulfilment of the provisions of this convention and shall forthwith inform the Secretary General of the International Civil Aviation Organization of these measures.

#### ARTICLE XVI

For the purpose of this Convention the term “**aircraft**” shall include the airframe, engines, propellers, radio apparatus and all other articles intended for use in the aircraft whether installed therein or temporarily separated therefrom.

#### ARTICLE XVII

If a separate register of aircraft for purposes or nationality is maintained in any territory for whose foreign relations a Contracting State is responsible, references in this Convention to the law of the contracting State shall be constituted as reference to the law of that territory.

#### ARTICLE XVIII

This Convention shall remain open for signature until it comes into force in accordance with the provisions of Article XX.

#### ARTICLE XIX

This Convention shall be subject to ratification by the signatory States.

The instruments of ratification shall be deposited in the archives of the International Civil Aviation Organization, which shall give notice of the date of deposit to each of the signatory and adhering States.

#### ARTICLE XX

**1.** As soon as two of the signatory States have deposited their instruments of ratification of this Convention, it shall come into force between them on the ninetieth day after the date of the deposit of the second instrument of ratification. It shall come into force, for each State which deposits its instrument of ratification after that date, on the ninetieth day after the deposit of its instrument of ratification.

**2.** The International Civil Aviation Organization shall give notice to each signatory State of the date on which this Convention comes into force.

**3.** As soon as this Convention comes into force, it shall be registered with the United Nations by the Secretary General of the International Civil Aviation Organization.

#### ARTICLE XXI

**1.** This Convention shall, after it has come into force, be open for adherence by non-signatory States.

**2.** Adherence shall be effected by the deposit of an instrument of adherence in the archives of the International Civil Aviation Organization, which shall give notice of the date of the deposit to each signatory and adhering State.

**3.** Adherence shall take effect as from the ninetieth day after the date of the deposit of the instrument of adherence in the archives of the International Civil Aviation Organization.

#### ARTICLE XXII

1. Any Contracting State may denounce this Convention by notification of denunciation to the International Civil Aviation Organization, which shall give notice of the receipt of such notification to each signatory and adhering State.

2. Denunciation shall take effect six months after the date of receipt by the International Civil Aviation Organization of the notification of denunciation.

#### ARTICLE XXIII

1. Any State may at the time of deposit of its instrument of ratification or adherence, declare that its acceptance of this Convention does not apply to any one or more of the territories for the foreign relations of which such State is responsible.

2. The International Civil Aviation Organization shall give notice of any such declaration to each signatory and adhering State.

3. With the exception of territories in respect of which a declaration has been made in accordance with paragraph 1 of this Article, this Convention shall apply to all territories for the foreign relations of which a Contracting State is responsible.

4. Any State may adhere to this Convention separately on behalf of all or any of the territories regarding which it has made a declaration in accordance with paragraph 1 of this Article and the provisions of paragraphs 2 and 3 of Article XXI shall apply to such adherence.

5. Any Contracting State may denounce this Convention, in accordance with the provisions of Article XXII, separately for all or any of the territories for the foreign relations of which such State is responsible.

IN WITNESS WHEREOF the undersigned plenipotentiaries having been duly authorized, have signed this Convention.

DONE at Geneva, on the nineteenth day of the month of June of the year one thousand nine hundred and forty-eight in the English, French and Spanish languages, each text being of equal authenticity.

This Convention shall be deposited in the archives of the International Civil Aviation Organization where, in accordance with Article XVIII, it shall remain open for signature.

---

#### FIFTH SCHEDULE

[Section 73 (2)]

*A - Convention on International Interests in Mobile Equipment*

THE STATES PARTIES TO THIS CONVENTION.

AWARE of the need to acquire and use mobile equipment of high value or particular economic significance and to facilitate the financing of the acquisition and use of such equipment in an efficient manner;

RECOGNISING the advantage of asset- based financing and leasing for this purpose and desiring to facilitate these types of transaction by establishing clear rules to govern them;

MINDFUL of the need to ensure that interest in such equipment are recognised and protected universally;

DESIRING to provide broad and mutual economic benefits for all interested parties;

BELIEVING that such rules must reflect the principles underlying asset-based financing and leasing and promote the autonomy of the parties necessary in these transactions;

CONSCIOUS of the need to establish a legal framework for international interests in such equipment and for that purpose to create an international registration system for their protection;

TAKING INTO CONSIDERATION the objective and Principles enunciated in existing Conventions relating to such equipment,

HAVE AGREED upon the following provisions:

## CHAPTER 1

### *Sphere of Application and General Provisions*

#### ARTICLE 1

##### *Definitions*

In this Convention, except where the context otherwise requires, the following items are employed with the meaning set out below:

- (a) **“agreement”** means a security agreement, a title agreement or a leasing agreement;
- (b) **“assignment”** means a contract which, whether by way of security or otherwise, confers on the assignee associated rights with or without a transfer of the related international interest;
- (c) **“associated rights”** means all rights to payment or other performance by a debtor under an agreement which are secured by or associated with the object;
- (d) **“commencement of the insolvency proceedings”** means the time at which the insolvency proceedings are deemed to commence under the applicable insolvency law;
- (e) **“conditional buyer”** means a buyer under a title reservation agreement;
- (f) **“conditional seller”** means a seller under a title reservation agreement;

(g) **“contract of sale”** means a contract for the sale of an object by a seller to a buyer which is not an agreement as defined in (a) above;

(h) **“court”** means a court of law or an administrative or arbitral tribunal established by a Contracting State;

(i) **“creditor”** means a court chargee under a security agreement, a conditional seller under a title reservation agreement or a lessor under a leasing agreement;

(j) **“debtor”** means a charger under a security agreement a conditional buyer under a title reservation agreement, a lessee under a leasing agreement or a person whose interest in an object is burdened by a registrable non-consensual right or interest;

(k) **“insolvency administrator”** means a person authorized to administer the reorganization or liquidation, including one authorized on an interim basis and includes a debtor in possession if permitted by the applicable insolvency law;

(l) **“insolvency proceedings”** means bankruptcy, liquidation or other collective judicial or administrative proceedings including interim proceedings, in which the assets and affairs of the debtor are subject to control or supervision by a court for the purposes of re-organization or liquidation;

(m) **“interested persons”** means -

- (i) the debtor;
- (ii) any person who, for the purpose of assuring performance of any of the obligations in favour of the creditor, gives or issues a suretyship or demand guarantee or a standby letter of credit or any other loan of credit insurance;
- (iii) any other person having rights in or over the object.

(n) **“internal transaction”** means a transaction of a type listed in Article 2 (2) (a) to (c) where the centre of the main interests of all parties to such transaction is situated, and the relevant object located (as specified in the Protocol), in the same Contracting State at the time of the conclusion of the contract and where the interest created by the transaction has been registered in a national registry in that Contracting State which has made a declaration under Article 50 (1);

(o) **“international interest”** means an interest held by the creditor to which Article 2 applies;

(p) **“international registry”** means the international registration facilities established for the purpose of this Convention or the Protocol;

(q) **“leasing agreement”** means an agreement by which one person (the lessor) grants a right to possession or control of an object (with or without an option of purchase) to another person (the lessee) in return for a rental or other payment;



- (r) **“national interest”** means an interest held by a creditor in an object and created by an internal transaction covered by a declaration under Article 50 (1);
- (s) **“non-consensual right or interest”** means a right or interest conferred under the law of a Contracting State which has made a declaration under Article 39 to secure the performance of an obligation including an obligation to a State, State entity or an inter-governmental or private organization;
- (t) **“notice of a national interest”** means notice registered or to be registered in the international Registry that a national interest has been created;
- (u) **“object”** means an object of category to which Article 2 applies;
- (v) **“pre-existing right or interest”** means a right or interest of any kind in or over an object created or arising before the effective date of this Convention as defined by Article 60 (2) (a);
- (w) **“proceeds”** means money or non-money proceeds of an object arising from the total or partial loss or physical destruction of the object or its total or partial confiscating, condemnation or re-acquisition
- (x) **“prospective assignment”** means an assignment that is intended to be made in the future upon the occurrence of a stated event, whether or not the occurrence of the event is certain;
- (y) **“prospective international interest”** means an interest that is intended to be created or provided for in an object as an international interest in the future, upon the occurrence of a stated event (which may include the debtor's acquisition of an interest in the object), whether or not the occurrence of the event is certain;
- (aa) **“prospective sale”** means a sale which is intended to be made in the future, upon the occurrence of a stated event, whether or not the occurrence of the event is certain;
- (bb) **“protocol”** means in respect of any category of object and associated rights to which this Convention applies the protocol in respect of that category of object and associated rights;
- (cc) **“registered”** means registered in the International Registry pursuant to Chapter V;
- (dd) **“registered interest”** means an international interest, a registrable non-consensual right or interest or a national interest specified in a notice of a national interest registered pursuant to Chapter V;
- (ee) **“registrable non-consensual right or interest”** means a non-consensual right or interest registrable pursuant to a declaration deposited under Article 40;
- (ff) **“registrar”** means, in respect of the Protocol, the person or body designated by that Protocol or appointed under Article 17 (2) (b);
- (gg) **“regulations”** means regulations made or approved by the Supervisory Authority pursuant to the Protocol;
- (hh) **“sale”** means a transfer of ownership of an object pursuant to a contract of sale;

(ii) **“secured obligation”** means an obligation secured by a security interest;

(jj) **“security agreement”** means an agreement by which a chargor grants or agrees to grant to a chargee an interest (including an ownership interest) in or over an object to secure the performance of any existing or further obligation of the chargor or a third person;

(kk) **“security interest”** means an interest created by a security agreement;

(ll) **“supervisory authority”** means, in respect of the Protocol the supervisory authority referred to in Article 17 ( l );

(mm) **“title reservation agreement”** means an agreement for the sale of an object on terms that ownership does not pass until fulfillment of the condition or conditions stated in the agreement;

(nn) **“unregistered interest”** means a consensual interest or non-consensual interest (other than an interest to which Article 39 applies) which has not been registered, whether or not it is registrable under this Convention; and

(oo) **“writing”** means a record of information (including information communicated by teletransmission) which is in tangible or other form and is capable of being reproduced in tangible form on of subsequent occasion and which indicates by reasonable means a person’s approval of the record.

## ARTICLE 2

### *The International Interest*

**1.** This Convention provides for the constitution and effects of an international interest in certain categories of mobile equipment and associated rights.

**2.** For the purposed of this Convention, an international interest in mobile equipment is an interest, constituted under Article 7, in a uniquely identifiable object of a category of such objects listed in paragraph 3 and designated in the protocol -

(a) granted by the chargor under a security agreement;

(b) vested in a person who is the conditional seller under a title reservation agreement; or

(c) vested in a person who is the lessor under a leasing agreement.

An interest falling within subparagraph (a) does not also fall within the sub paragraph (b) or (c).

**3.** The categories referred to in the preceding paragraphs are -

(a) airframes, aircraft engines and helicopters;

(b) railway rolling stock; and

(c) space assets.

4. The applicable law determines whether an interest to which paragraph 2 applies falls within subparagraphs (a), (b) or (c) of that paragraph.

5. An international interest in an object extends to proceeds of that object.

### ARTICLE 3

#### *Sphere of Application*

1. This Convention applies when, at the time of the conclusion of the agreement creating or providing for the international interest, the debtor is situated in a Contracting State.

2. The fact that the creditor is situated in a non-Contracting State does not affect the applicability of this Convention.

### ARTICLE 4

#### *Where Debtor is Situated*

1. For the purpose of Article 3 (1), the debtor is situated in any Contracting State-

(a) under the law of which it is incorporated or formed;

(b) where it has its registered office or statutory seat;

(c) where it has its centre of administration; or

(d) where it has its place of business.

2. A reference in subparagraph (d) of the preceding paragraph to the debtor's place of business shall, if it has more than one place of business, mean its principal place of business or, if it has no place of business, its habitual residence.

### ARTICLE 5

#### *Interpretation and Applicable Law*

1. In the interpretation of this Convention, regard is to be had to its purposes as set forth in the preamble, to its international character and to the need to promote uniformity and predictability in its application.

2. Questions concerning matters governed by this Convention which are not expressly settled in it are to be settled in conformity with the general principles on which it is based, or, in the absence of such principles, in conformity with the applicable law.

3. References to the applicable law are to the domestic rules of the law applicable by virtue of the rules of private international law of the forum State.

4. Where State comprises several territorial units, each of which has its own rules of law in respect of the matter to be decided, and where there is no indication of the relevant territorial unit, the law of that State decides which is the territorial unit whose rules shall govern in the absence of any such rule, the law of the territorial unit with which the case is most closely connected shall apply.

## ARTICLE 6

### *Relationship between the Convention and the Protocol*

1. This Convention and the Protocol shall be read and interpreted together as a single instrument.
2. To the extent of any inconsistency between this Convention and the Protocol, the Protocol shall prevail.

## CHAPTER II

### *Constitution of an International Interest*

## ARTICLE 7

### *Formal Requirements*

An interest is constituted as an international interest under this Convention where the agreement creating or providing for the interest-

is in writing;

relates to an object of which the chargor, conditional seller or lessor has power to dispose;

enables the object to be identified in conformity with the Protocol; and

in the case of a security agreement, enables the secured obligations to be determined, but without the need to state a sum or maximum sum secured.

## CHAPTER III

### *Default Remedies*

## ARTICLE 8

### *Remedies of Chargee*

1. In the event of default as provided in Article 11, the chargee may, to the extent that the chargor has at any time so agreed and subject to any declaration that may be made by a Contracting State under Article 54, exercise any one or more of the following remedies -

(a) take possession or control of any object charged to it;

(b) sell or grant a lease of any such object;

(c) collect or receive any income or profits arising from the management or use of any such object.

**2.** The chargee may alternatively apply for a court order authorizing or directing any of the acts referred to in the preceding paragraph.

**3.** Any remedy set out in subparagraphs (a), (b) or (c) of paragraph 1 or by Article 13 shall be exercised in a commercially reasonable manner. A remedy shall be deemed to be exercised in a commercially reasonable manner where it is exercised in conformity with a provision of the security agreement except where such a provision is manifestly unreasonable.

**4.** A chargee proposing to sell or grant a lease of an object under paragraph 1 shall give reasonable prior notice in writing of the proposed sale or lease to-

interested persons specified in Article 1 (m) (i) and (ii); and

interested persons specified in article 1 (m) (iii) who have given notice of their rights to the chargee within a reasonable time prior to the sale or lease.

**5.** Any sum collected or received by the chargee as a result of exercise of any of the remedies set out in paragraph 1 or 2 shall be applied towards discharge of the amount of the secured obligations.

**6.** Where the sums collected or received by the chargee as a result of the exercise of any remedy set out in paragraph 1 or 2 exceed the amount secured by the security interest and any reasonable costs incurred in the exercise of any such remedy, then unless otherwise ordered by the court the chargee shall distribute the surplus among holders of subsequently ranking interests which have been registered or of which the chargee has been given notice, in order of priority, and pay any remaining balance to the chargor.

## ARTICLE 9

### *Vesting of Object in Satisfaction Redemption*

**1.** At any time after default as provided in Article 11, the chargee and all the interested persons may agree that ownership of (or any other interest of the chargor in) any object covered by the security interest shall vest in the chargee in or towards satisfaction of the secured obligations.

**2.** The court may on the application of the chargee order that ownership of (or any other interest of the chargor in) any object covered by the security interest shall vest in the chargee in or towards satisfaction of the secured obligations.

**3.** The court shall grant any application under the preceding paragraph only if the amount of the secured obligations to be satisfied by such vesting is commensurate with the value of the object after taking account of any payment to be made by the chargee to any of the interested persons.

**4.** At any time after default as provided in Article II and before sale of the charged object or the making of an order under paragraph 2. the charger or any interested person may discharge the security interest

by paying in full the amount secured, subject to any lease granted by the chargee under Article 8 (1) (b) or ordered under Article 8 (2). Where after such default, the payment of the amount secured is made in full by an interested person other than the debtor, that person is subrogated to the rights of chargee.

5. Ownership or any other interest of the chargor passing on a sale under Article 8 (1) (b) or passing under paragraph 1 or 2 of this Article is free from any other interest over which the charge's security interest has priority under the provisions of Article 29.

## ARTICLE 10

### *Remedies of Conditional Seller or Lessor*

In the event of default under a title reservation agreement or under a leasing agreement as provided in Article 11, the conditional seller or the lessor, as the case may be, may -

(a) subject to any declaration that may be made by a Contracting State under Article 54, terminate the agreement and take possession or Control of any object to which the agreement relates; or

(b) apply for a court order authorizing or directing either of these acts.

## ARTICLE 11

### *Meaning of Default*

1. The debtor and the creditor may at any time agree in writing as to the events that constitute a default or otherwise give rise to the rights and remedies specified in Articles 8 to 10 and 13.

2. Where the debtor and the creditor have not so agreed, "**default**" for the purpose of Articles 8 to 10 and 13 means a default which substantially deprives the creditor of what it is entitled to expect under the agreement.

## ARTICLE 12

### *Additional Remedies*

Any additional remedies permitted by the applicable law, including any remedies agreed upon by the parties, may be exercised to the extent that they are not inconsistent with the mandatory provisions of this Chapter as set out in Article 15.

## ARTICLE 13

### *Relief Pending Final Determination*

1. Subject to any declaration that it may make under Article 55, a Contracting State shall ensure that a creditor who adduces evidence of default by the debtor may, pending final determination of its claim and to the extent that the debtor has at any time so agreed, obtain from a court speedy relief in the form of such one or more of the following orders as the creditor requests:

- (a) preservation of the object and its value;
- (b) possession, control or custody of the objects;
- (c) Immobilization of the object; and
- (d) lease, or except where covered by sub-paragraphs (a) to (c), management of the object and the income therefrom.

**2.** In making any order under the preceding paragraph, the court may impose such terms as it considers necessary to protect the interested persons in the event that the creditor -

(a) in implementing any order granting such relief, fails to perform any of its obligation to the debtor under this Convention or the protocol; or

(b) fails to establish its claim, wholly or in part, on the final determination of that claim.

**3.** Before making any order under paragraph 1, the court may require notice of the request to be given to any of the interested persons.

**4.** Nothing in this Article affects the application of Article 8 (3) or limits the availability of forms of interim relief other than those set out in paragraph 1.

#### ARTICLE 14

##### *Procedural Requirement*

Subject to Article 54 (2), any remedy provided by this Chapter shall be exercised in conformity with the procedure prescribed by the law of the place where the remedy is to be exercised.

#### ARTICLE 15

##### *Derogation*

In their relations with each other, any two or more of the parties referred to in this Chapter may at any time, by agreement in writing, derogate from or vary the effect of any of the preceding provisions of this Chapter except Articles 8 (3) to (6), 9 (3) and (4), 13 (2) and 14.

#### CHAPTER IV

##### *The International Registration System*

#### ARTICLE 16

##### *The International Registry*

**1.** An International Registry shall be established for registration of-

(a) international interest, prospective international interests and registrable non-consensual right and interests;

(b) assignment and prospective assignments of international interest;

(c) acquisition of international interests by legal or contractual subrogations under the applicable law;

(d) notice of national interests; and

(e) subordinations of interests referred to in any of the proceeding sub-paragraphs.

2. Different international registries may be established for different categories of object and associated rights.

3. For the purpose of this Chapter and Chapter V, the term “**registration**” includes where appropriate, an amendment, extension or discharge of a registration

## ARTICLE 17

### *The Supervisory Authority and the Registrar*

1. There shall be a Supervisory Authority as provided by the Protocol.

2. The Supervisory Authority shall-

(a) establish or provide for the establishment of the International Registry;

(b) except as otherwise provided by the Protocol, appoint and dismiss the Registrar;

(c) ensure that any rights required for the continued effective operation of the International Registry in the event of a change of Registrar will vest in or be assignable to the new Registrar;

(d) after consultation with the Contracting States, make or approve and ensure the publication of regulations pursuant to the to the Protocol dealing with the operation of the International Registry;

(e) establish administrative procedures through which complaints concerning the operation of the International Registry can be made to the Supervisory Authority;

(f) supervise the Registrar and the operation of the International Registry;

(g) at the request of the Registrar, provide such guidance to the Registrar as the Supervisory Authority thinks fit;

(h) set and periodically review the structure of fees to be charged for the services and facilities of the International Registry;

(i) do all things necessary to ensure that an efficient notice-based electronic registration system exist to implement the objectives of this Convention and the Protocol; and



(j) report periodically to Contracting States concerning the discharge of its obligations under this Convention and the Protocol.

**3.** The Supervisory Authority may enter into any agreement requisite for the performance of its functions, including any agreement referred to in Article 27 (3).

**4.** The Supervisory Authority shall own all proprietary rights in the databases and archives of the International Registry.

**5.** The Registrar shall ensure the efficient operation of the International Registry and perform the functions assigned to it by this Convention, the protocol and the regulations.

## CHAPTER V

### *Other Matters Relating To Registration*

## ARTICLE 18

### *Registration Requirements*

**1.** The Protocol and regulations shall specify the requirements, including the criteria for the identification of the object-

(a) for effecting a registration (which shall include provision for prior electronic transmission of any consent from any person whose consent is required under Article 20);

(b) for making searches and issuing search certificates, and, subject thereto;

(c) for ensuring the confidentiality of information and documents of the International Registry other than information and documents relating to a registration.

**2.** The Registrar shall not be under a duty to enquire whether a consent to registration under Article 20 has in fact been given or is valid.

**3.** Where an interest registered as a prospective international interest becomes an international interest, no further registration shall be required provided that the registration information is sufficient for registration of an international interest.

**4.** The Registrar shall arrange for registrations to be entered into the International Registry data base and made searchable in chronological order of receipt, and the file shall record the date and time of receipt.

**5.** The Protocol may provide that a Contracting State may designate an entity or entities in its territory as the entry point or entry points through which the information required for registration shall or may be transmitted to the International Registry. A Contracting State making such a designation may specify requirements, if any, to be satisfied before such information is transmitted to the International Registry.

## ARTICLE 19

### *Validity and Time of Registration*

1. A registration shall be valid only if made in conformity with Article 20.
2. A registration, if valid, shall be completed upon entry of the required information into the International Registry database so as to be searchable.
3. A registration shall be searchable for the purpose of the preceding paragraph at the time when the International Registry has assigned to it a sequentially ordered the number; and the registration information, including the number, is stored in durable form and may be accessed at the International Registry.
4. If an interest first registered as a prospective international interest becomes an international interest, that international interest shall be treated as registered from the time of registration of the prospective international interest provided that the registration was still current immediately before the international interest was constituted as provided by Article 7.
5. The preceding paragraph applies with necessary modifications to the registration of a prospective assignment of an international interest.
6. A registration shall be searchable in the International Registry data base according to the criteria prescribed by the Protocol.

## ARTICLE 20

### *Consent to Registration*

1. An international interest, a prospective international interest or an assignment or prospective assignment of an international interest maybe registered, and any such registration amended or extended prior to its expiry, by either party with the consent in writing of the other.
2. The subordination of an international interest to another international interest may be registered by or with the consent in writing at any time of the person whose interest has been subordinated.
3. A registration may be discharged by or with the consent in writing of the party in whose favour it was made.
4. The acquisition of an international interest by legal or contractual subrogation may be registered by the subrogee.
5. A registrable non-consensual right or interest may be registered by the holder thereof.
6. A notice of a national interest may be registered by the holder thereof.

## ARTICLE 21

### *Duration of Registration*

Registration of an international interest remains effective until discharged or until expiry of the period specified in the registration.

### ARTICLE 22

#### *Searches*

1. Any person may, in the manner prescribed by the Protocol and regulations, make or request a search of the International Registry by electronic means concerning interests or prospective international interests registered therein.
2. Upon receipt of a request therefore, the Registrar, in the manner prescribed by the Protocol and regulations, shall issue a registry search certificate by electronic means with respect to any object -
  - (a) stating all registered information relating thereto, together with a statement indicating the date and time of registration of such information; or
  - (b) stating that there is no information in the International Registry relating thereto.
3. A search certificate issued under the preceding paragraph shall indicate that the creditor named in the registration information has acquired or intends to acquire an international interest in the object but shall not indicate whether what is registered is an international interest or a prospective international interest, even if this is ascertainable from the relevant registration information.

### ARTICLE 23

#### *List of Declarations and Declared Non-consensual Rights or Interests*

The Registrar shall maintain a list of declarations, withdrawals of declaration, and of the categories of non-consensual right or interest communicated to the Registrar by the Depository as having been declared by Contracting States in conformity with Article 39 and 40 and the date of each such declaration or withdrawal of declaration. Such list shall be recorded and searchable in the name of the declaring State and shall be made available as provided in the Protocol and regulations to any person requesting it.

### ARTICLE 24

#### *Evidentiary Value or Certificates*

A document in the form prescribed by the regulations which purports to be a certificate issued by the International Registry is *prima facie* proof-

that it has been so issued; and

of the facts recited in it, including the date and time of registration.

## ARTICLE 25

### *Discharge of Registration*

1. Where the obligations secured by a registered security interest or the obligations giving rise to a registered non-consensual right or interest have been discharged, or where the conditions of transfer of title under a registered title reservation agreement have been fulfilled, the holder of such interest shall, without undue delay, procure the discharge of the registration after written demand by the debtor delivered to or received at its address stated in the registration.
2. Where a prospective international interest or a prospective assignment of an international interest has been registered, the intending assignee shall, without undue delay, procure the discharge of the registration after written demand by the intending debtor or assignor which is delivered to or received at its address stated in the registration before the intending creditor or assignee has given value or incurred a commitment to give value.
3. Where the obligations secured by a national interest specified in a registered notice of a national interest have been discharged, the holder of such interest shall, without undue delay, procure the discharge of the registration after written demand by the debtor delivered to or received at its address stated in the registration.
4. Where a registration ought not to have been made or is incorrect, the person in whose favour the registration was made shall, without undue delay, procure its discharge or amendment after written demand by the debtor delivered to or received at its address stated in the registration.

## ARTICLE 26

### *Access to the International Registration Facilities*

No person shall be denied access to the registration and search facilities of the International Registry on any ground other than its failure to comply with the procedures prescribed by this Chapter.

## CHAPTER VI

### *Privileges and Immunities of the Supervisory Authority and the Registrar*

## ARTICLE 27

### *Legal Personality; Immunity*

1. The Supervisory Authority shall have international legal personality where not already possessing such personality.
2. The Supervisory Authority and its officers and employees shall enjoy such immunity from legal or administrative process as is specified in the Protocol.

3. (a) The supervisory Authority shall enjoy exemption from taxes and such other privileges as may be provided by agreements with the host State.

(b) For the purpose of this paragraph, “**host state**” means the State in which the Supervisory Authority is situated.

4. The assets, documents, databases and archives of the International Registry shall be inviolable and immune from seizure or other legal or administrative process.

5. For the purposes of any claim against the Registrar under Article 28 (1) or Article 44, the claimant shall be entitled to access to such information and documents as are necessary to enable the claimant to pursue its claim.

6. The Supervisory Authority may waive the inviolability and immunity conferred by paragraph 4.

## CHAPTER VII

### *Liability of the Registrar*

## ARTICLE 28

### *Liability and Financial Assurance*

1. The Registrar shall be liable for compensatory damages for loss suffered by a person directly resulting from an error or omission of the Registrar and its officers and employees or from a malfunction of the international registration system except where the malfunction is caused by an event of an inevitable and irresistible nature, which could not be prevented by using the best practices in current use in the field of electronic registry design and operation, including those related to back-up and systems security and networking.

2. The Registrar shall not be liable under the preceding paragraph for factual inaccuracy of registration information received by the Registrar or transmitted by the Registrar in the form in which it received that information nor for acts or circumstances for which the registrar and its officers and employees are not responsible and arising prior to receipt of registration information at the International Registry.

3. Compensation under paragraph 1 may be reduced to the extent that the person who suffered the damage caused or contributed to that damage.

4. The Registrar shall procure insurance or a financial guarantee covering the liability referred to in this Article to the extent determined by the Supervisory Authority, in accordance with the Protocol.

## CHAPTER VIII

### *Effects of an International Interest as Against Third Parties*

## ARTICLE 29

### *Priority of Competing Interests*

1. A registered interest has priority over interest subsequently registered and over; an unregistered interest.
2. The priority of the first-mentioned interest under the preceding paragraph applies
  - (a) even if the first-mentioned interest was acquired or registered with actual knowledge of the other interest; and
  - (b) even as regards value given by the holder of the first-mentioned interest with such knowledge.
3. The buyer of an object acquires its interest in it
  - (a) subject to an interest registered at the time of its acquisition of that interest; and
  - (b) free from an unregistered interest even if it has actual knowledge of such an interest.
4. The conditional buyer or lessee acquires its interest in or right over that object
  - (a) subject to an interest registered prior to the registration of the international interest held by its conditional seller or lessor; and
  - (b) free from an interest not so registered at that time even if it has actual knowledge of that interest.
5. The priority of competing interests or rights under this Article may be varied by agreement between the holders of those interests, but an assignee of a subordinated interest is not bound by an agreement to subordinate that interest unless at the time of the assignment a subordination had been registered relating to that agreement.
6. Any priority given by this Article to an interest in an object extends to proceeds.
7. This Convention-
  - (a) does not affect the rights of a person in an item, other than an object, held prior to its installation on an object if under the applicable law those rights continue to exist after the installation;; and
  - (b) does not prevent the creation of rights in an item, other than an object, which has previously been installed on an object where under the applicable law those rights are created.

### ARTICLE 30

#### *Effects of Insolvency*

1. In insolvency proceedings against the debtor an international interest is effective if prior to the commencement of the insolvency proceedings that interest was registered in conformity with this Convention.

**2.** Nothing in this Article impairs the effectiveness of an international interest in the insolvency proceedings where that interest is effective under the applicable law.

**3.** Nothing in this Article affects-

(a) any rules of law applicable in insolvency proceedings relating to the avoidance of a transaction as a preference or a transfer in fraud of creditors; or

(b) any rules of procedure relating to the enforcement of rights to property which is under the control or supervision of the insolvency administrator.

## CHAPTER IX

### *Assignments of Associated Rights and International Interests; Rights of Subrogation*

#### ARTICLE 31

##### *Effects of Assignment*

**1.** Except as otherwise agreed by the parties, an assignment of associated rights made in conformity with Article 32 also transfers to the assignee-

the related international interest; and

all the interests and priorities of the assignor under this Convention.

**2.** Nothing in this Convention prevents a partial assignment of the assignor's associated rights. In the case of such a partial assignment the assignor and assignee may agree as to their respective rights concerning the related international interest assigned under the preceding paragraph but not so as adversely to affect the debtor without its consent.

**3.** Subject to paragraph 4, the applicable law shall determine the defences and rights of set-off available to the debtor against the assignee.

**4.** The debtor may at any time by agreement in writing waive all or any of the defences and rights of set-off referred to in the preceding paragraph other than defences arising from fraudulent acts on the part of the assignee.

**5.** In the case of an assignment by way of security, the assigned associated rights revert in the assignor, to the extent that they are still subsisting, when the obligations secured by the assignment have been discharged.

#### ARTICLE 32

##### *Formal Requirements for Assignment*

**1.** An assignment of associated rights transfers the related international interest only if it

(a) is in writing;

(b) enables the associated rights to be identified under the contract from which they arise; and

(c) in the case of an assignment by way of security, enables the obligations secured by the assignment to be determined in accordance with the Protocol but without the need to state a sum or maximum sum secured.

**2.** An assignment of an international interest created or provided for by a security agreement is not valid unless some or all related associated rights also are assigned.

**3.** This Convention does not apply to an assignment of associated rights which is not effective to transfer the related international interest.

## ARTICLE 33

### *Debtor's Duty to Assignee*

**1.** To the extent that associated rights and the related international interest have been transferred in accordance with Articles 31 and 32, the debtor in relation to those rights and that interest is bound by the assignment and has a duty to make payment or give other performance to the assignee, if but only if-

(a) the debtor has been given notice of the assignment in writing by or with the authority of the assignor; and

(b) the notice identifies the associated rights.

**2.** Irrespective of any other ground on which payment or performance by the debtor discharges the latter from liability, payment or performance shall be effective for this purpose if made in accordance with the preceding paragraph.

**3.** Nothing in this Article shall affect the priority of competing assignments.

## ARTICLE 34

### *Default Remedies in respect of Assignment by Way of Security*

In the event of default by the assignor under the assignment of associated rights and the related international interest made by way of security, Articles 8, 9 and 11 to 14 apply in the relations between the assignor and the assignee (and in relation to associated rights, apply in so far as those provisions are capable of application to intangible property) as if references-

(a) to the secured obligation and the security interest were references to the obligation secured by the assignment of the associated rights and the related international interest and the security interest created by that assignment;



- (b) to the chargee or creditor and charger or debtor were references to the assignee and assignor;
- (c) to the holder of the international interest were references to the assignee; and
- (d) to the object were references to the assigned associated rights and the related international interest.

## ARTICLE 35

### *Priority of Competing Assignments*

1. Where there are competing assignments of associated rights and at least one of the assignment includes the related international interest and is registered, the provisions of Article 29 apply as if the references to a registered interest were references to an assignment of the associated rights and the related registered interest and as if references to a registered or unregistered interest were references to a registered or unregistered assignment.
2. Article 30 applies to an assignment of associated rights as if the references to an international interest were references to an assignment of the associated rights and the related international interest.

## ARTICLE 36

### *Assignee's Priority with respect to Associated Rights*

1. The assignee of associated rights and the related international interest whose assignment has been registered only has priority under Article 35 (1) over another assignee of the associated rights-
  - (a) if the contract under which the associated rights arise states that they are secured by or associated with the object; and
  - (b) to the extent that the associated rights are related to an object.
2. For the purpose of subparagraph (b) of the preceding paragraph, associated rights are related to an object only to the extent that they consist of rights to payment or performance that relate to:
  - (a) a sum advanced and utilised for the purchase of the object;
  - (b) a sum advanced and utilised for the purpose of another object in which the assignment hold another international interest if the assignor transferred that interest to the assignee and the assignment has been registered;
  - (c) the price payable for the object;
  - (d) the rentals payable in respect of the object; orother obligations arising from a transaction referred to in any of the preceding paragraphs.
3. In all other cases, the priority of the competing assignments of the associated rights shall be determined by the applicable law.

## ARTICLE 37

### *Effects of Assignors Insolvency*

The provisions of Article 30 apply to insolvency proceedings against the assignor as if references to the debtor were references to the assignor.

## ARTICLE 38

### *Subrogation*

1. Subject to paragraph 2, nothing in this Convention affects the acquisition of associated rights and the related international interest by legal or contractual subrogation under the applicable law.
2. The priority between any interest within the preceding paragraph and a competing interest may be varied by agreement in writing between the holders of the respective interests but an assignee of a subordinated interest is not bound by an agreement to subordinate that interest unless at the time of the assignment a subordination had been registered relating to that agreement.

## CHAPTER X

### *Rights or Interests Subject to Declarations by Contracting States*

## ARTICLE 39

### *Rights having Priority without Registration*

1. A Contracting State may at any time, in a declaration deposited with the Depository of the Protocol declare, generally or specifically-
  - (a) those categories of non-consensual rights or interest (other than a right or interest to which Article 40 applies) which under that State's law have priority over an interest in an object equivalent to that of the holder of a registered international interest and which shall have priority over a registered international interest, whether in or outside insolvency proceedings; and
  - (b) that nothing in this Convention shall affect the right of a State entity, intergovernmental organization or other private provider of public services to arrest or detain an object under the law of that State for payment of amounts owed to such entity, organization or provider directly relating to those services in respect of that object or another object.
2. A declaration made under the preceding paragraph may be expressed to cover categories that are created after the deposit of that declaration.
3. A non-consensual right or interest has priority over an international interest if and only if the former is of a category covered by a declaration deposited prior to the registration of the international interest.

4. Notwithstanding the preceding paragraph, a contracting State may, at the time of ratification, acceptance, approval of, or accession to the Protocol, declare that a right or interest of a category covered by a declaration made under subparagraph (a) of paragraph 1 shall have priority over an international interest registered prior to the date of such ratification, acceptance, approval or accession.

#### ARTICLE 40

##### *Registrable Non-consensual Rights or Interests*

A Contractual State may at any time in a declaration deposit with the Depository of the Protocol list the categories of non-consensual right or interest which shall be registrable under this Convention as regards any category of object as if the right or interest were an international interest and shall be registered accordingly. Such a declaration may be modified from time to time.

#### CHAPTER XI

##### *Application of the Convention to Sales*

#### ARTICLE 41

##### *Sale and Prospective Sale*

This Convention shall apply to the sale or prospective sale of an object as provided for in the Protocol with any modifications therein.

#### CHAPTER XII

##### *Jurisdiction*

#### ARTICLE 42

##### *Choice of Forum*

1. Subject to Articles 43 and 44, the courts of a Contracting State chosen by the parties to a transaction have jurisdiction in respect of any claim brought under this Convention, whether or not the chosen forum has connection with the parties or the transaction. Such jurisdiction shall be exclusive unless otherwise agreed between the parties.

2. Any such agreement shall be in writing or otherwise concluded in accordance with the formal requirements of the law of the chosen forum.

#### ARTICLE 43

##### *Jurisdiction under Article 13*

1. The courts of a Contracting State chosen by the parties and the courts of the Contracting State on the territory of which the object is situated have jurisdiction to grant relief under Article 13 (1) (a), (b), (c) and Article 13 (4) in respect of that object.

2. Jurisdiction to grant relief under Article 13(1)(d) or other interim relief by virtue of Article 13 (4) may be exercised either-

by the courts chosen by the parties; or

by the courts of a Contracting State on the territory of which the debtor is situated, being relief which, by the terms of the order granting it, is enforceable only in the territory of that Contracting State.

3. A court has jurisdiction under the preceding paragraphs even if the final determination of the claim referred to in Article 13 (1) will or may take place in a court of another Contracting State or by arbitration.

#### ARTICLE 44

##### *Jurisdiction to make Orders against the Registrar*

1. The courts of the place in which the Registrar has its centre of administration shall have exclusive jurisdiction to award damages or make orders against the Registrar.

2. Where a person fails to respond to a demand made under Article 25 and that person has ceased to exist or cannot be found for the purpose of enabling an order to be made against it requiring it to procure discharge of the registration, the courts referred to in the preceding paragraph shall have exclusive jurisdiction, on the application of the debtor or intending debtor, to make an order directed to the Registrar requiring the Registrar to discharge the registration.

3. Where a person fails to comply with an order of a court having jurisdiction under this Convention or, in the case of a national interest, an order of a court of competent jurisdiction requiring that person to procure the amendment or discharge of a registration, the courts referred to in paragraph 1 may direct the Registrar to take such steps as will give effect to that order.

4. Except as otherwise provided by the preceding paragraphs, no court may make orders or give judgments or ruling against or purporting to bind the Registrar.

#### ARTICLE 45

##### *Jurisdiction in respect of Insolvency Proceedings*

The provisions of this Chapter are not applicable to insolvency proceedings.

#### CHAPTER XIII

##### *Relationship with other Conventions*

#### ARTICLE 45 bis

##### *Relationship with the United Nations Convention on the Assignment of Receivables in International Trade*

This Convention shall prevail over the *United Nations Convention on the Assignment of Receivables in International Trade*, opened for signature in New York on 12 December 2001, as it relates to the assignment of receivables which are associated rights related to international interests in aircraft object, railway rolling stock and space assets.

#### ARTICLE 46

##### *Relationship with the UNIDROIT Convention on International Finance Leasing*

The Protocol may determine the relationship between this Convention and the UNIDROIT Convention on International Finance Leasing, signed at Ottawa on 28 May 1988.

#### CHAPTER XIV

##### *Final Provisions*

#### ARTICLE 47

##### *Signature, Ratification, Acceptance, Approval or Accession*

1. This Convention shall be open for signature in Cape Town on 16 November 2001 by States participating in the Diplomatic Conference to Adopt a Mobile Equipment Convention and an Aircraft Protocol held at Cape Town from 29 October to 16 November 2001. After 16 November 2001, the Convention shall be open to all States for signal the Headquarters of International Institute for the Unification of Private Law (UNIDROIT) in Rome until it enters into force in accordance with Article 49.
2. This Convention shall be subject to ratification, acceptance or approval by States which have signed it.
3. Any State which does not sign this Convention may accede to it at any time.
4. Ratification, acceptance, approval or accession is effected by the deposit of a formal instrument to that effect with the Depository.

#### ARTICLE 48

##### *A Regional Economic Integration Organizations*

1. A Regional Economic Integration Organization which is constituted by soviet States and has competence over certain matters governed by this Convention similarly sign, accept, approve or accede to this Convention. The Regional Economic Integration Organization shall in that case have the rights and obligations of a Contracting State, to the extent that the Organization has competence over matters governed by this Convention. Where the number of Contracting States is relevant in this Convent the Regional Economic Integration Organization shall not count as a Contracting State in addition to its Member States which are Contracting States.
2. The Regional Economic Integration Organization shall, at the time of signature, acceptance, approval or accession, make a declaration to the Depository specifying matters governed by this Convention in

respect of which competence has been transferred to that Organization by its Member States. The Regional Economic Integral Organization shall promptly notify the Depository of any changes to the distribution of competence, including new transfers of competence, specified in the declaration under this paragraph.

**3.** Any reference to a “Contracting State” or “Contracting States” or “State Party or “States Parties” in this Convention applies equally to a Regional Economic Integrate Organization where the context so requires.

## ARTICLE 49

### *Entry into Force*

**1.** This Convention enters into force on the first day of the month following the expiration of three months after the date of the deposit of the third instrument ratification, acceptance, approval or accession but only as regards a category of object to which a Protocol applies-

(a) as from the time of entry into force to that Protocol;

(b) subject to the terms of that Protocol; and

(c) as between States Parties to this Convention and that Protocol.

**2.** For other States this Convention enters into force on the first day of the month following the expiration of three months after the date of the deposit of their instrument of ratification, acceptance, approval or accession but only as regards a category of objects to which a Protocol applies and subject, in relation to such Protocol, to the requirements of sub-paragraphs (a), (b) and (c) or the preceding paragraph.

## ARTICLE 50

### *Internal Transactions*

**1.** A Contracting State may, at the time of ratification, acceptance, approval of, or accession to the Protocol, declare that this Convention shall not apply to a transaction which is an internal transaction in relation to that State with regard to all types of objects or some of them.

**2.** Notwithstanding the preceding paragraph, the provisions of Articles 8 (4), 9 (1), 16, Chapter V, Article 29, and any provisions of this Convention relating to registered interest shall apply to an internal transaction.

**3.** Where notice of a national interest has been registered in the International Registry, the priority of the holder of that interest under Article 29 shall not be affected by the fact that such interest has become vested in another person by assignment or subrogation under the applicable law.

## ARTICLE 51

### *Future Protocols*

1. The Depository may create working groups, in cooperation with such relevant “non-governmental organizations as the Depository considers appropriate, to assess the feasibility of extending the application of this Convention, through one or more Protocols, to objects of any category of high-value mobile equipments, other than a category referred to in Article 2(3), each member of which is uniquely identifiable, and associated rights relating to such objects.
2. The Depository shall communicate the text of any preliminary draft Protocol relating to a category of objects prepared by such a working group to all States Parties to this Convention, all member States of the Depository, member States of the United Nations which are not members of the Depository and the relevant intergovernmental organizations, and shall invite such States and organizations to participate in intergovernmental negotiations for the completion of a draft Protocol on the basis of such a preliminary draft Protocol.
3. The Depository shall also communicate the text of any preliminary draft Protocol prepared by such a working group to such relevant non-governmental organizations as the Depository considers appropriate. Such non-governmental organizations shall be invited promptly to submit comments on the text of the preliminary draft Protocol to the Depository and to participate as observers in the preparation of a draft Protocol.
4. Where the competent bodies of the Depository adjudge such a draft Protocol ripe for adoption, the Depository shall convene a diplomatic conference for its adoption.
5. Once such a Protocol has been adopted, subject to paragraph 6, this Convention shall apply to the category of objects covered thereby.
6. Article 45 *bis* of this convention applies to such a Protocol only if specifically provided for in that Protocol.

## ARTICLE 52

### *Territorial Units*

1. If a Contracting State has territorial units in which different systems of law are applicable in relation to the matters dealt within this Convention, it may, at the time of ratification, acceptance, approval, or accession, declare that this Convention is to extend to all its territorial units or only to one or more of them and may modify its declaration by submitting another declaration at any time.
2. Any such declaration shall state expressly the territorial units to which this Convention applies.
3. If a Contracting State has not made any declaration under paragraph 1, this Convention shall apply to all territorial units of that State.
4. Where a Contracting State extends this Convention to one of its territorial units, declarations permitted under this Convention may be made in respect of each such territorial unit, and the

declarations made in respect of one territorial unit may be different from those made in respect of another territorial unit.

5. If by virtue of a declaration under paragraph 1, this Convention extends to one or more territorial units of a Contracting State-

(a) the debtor is considered to be situated in a Contracting State only if it is incorporated or formed under a law in force in a territorial unit to which this Convention applies or if it has its registered office or statutory seat, centre of administration, place of business or habitual residence in a territorial unit to which this Convention applies;

(b) any reference to the location of the object in a Contracting State refers to the location of the object in a territorial unit to which this Convention applies; and

(c) any reference to the administrative authorities in that Contracting State shall be construed as referring to the administrative authorities having jurisdiction in a territorial unit to which this Convention applies.

#### ARTICLE 53

##### *Determination of Courts*

A Contracting State may, at the time of ratification, acceptance, approval of, or accession to the Protocol, declare the relevant "court" or "courts" for the purposes of Article 1 and Chapter XII of this Convention.

#### ARTICLE 54

##### *Declarations Regarding Remedies*

1. A Contracting State may, at the time of ratification, acceptance, approval of, or accession to the Protocol, declare that while the charged objects is situated within, or controlled from its territory the chargee shall not grant a lease of the objects in that territory.

2. A Contracting State shall, at the time of ratification, acceptance, approval of, or accession to the Protocol, declare whether or not any remedy available to the creditor under any provisions of this Convention which is not there expressed to require application to the court may be exercised only with leave of the court.

#### ARTICLE 55

##### *Declaration regarding Relief pending Final Determination*

A Contracting State may, at the time of ratification, acceptance, approval of, or accession to the Protocol, declare that it will not apply the provisions of Article 13 or Article 43, or both, wholly or in part. The declaration shall specify under which conditions the relevant Article will be applied, in case it will be applied partly, or otherwise which other forms of interim relief will be applied.



## ARTICLE 56

### *Reservations and Declaration*

1. No reservations may be made to this Convention but declarations authorized by Articles 39, 40, 50, 52, 53, 54, 55, 57, 58 and 60 may be in accordance with these provisions.
2. Any declaration or subsequent declaration or any withdrawal of a declaration made under this Convention shall be notified in writing to the Depository.

## ARTICLE 57

### *Subsequent Declarations*

1. A State Party may make a subsequent declaration, other than a declaration authorized under Article 60, at any time after the date on which this convention has entered into force for it, by notifying the Depository to that effect.
2. Any such subsequent declaration shall take effect on the first day of the month following the expiration of six months after the date of receipt of the notification by the Depository. Where a longer period for that declaration to take effect is specified in the notification, it shall take effect upon the expiration of such longer period after receipt of the notification by the Depository.
3. Notwithstanding the previous paragraphs, this Convention shall continue to apply, as if no such subsequent declarations had been made, in respect of all rights and interests arising prior to the effective date of any such subsequent declaration.

## ARTICLE 58

### *Withdrawal of Declarations*

1. Any State Party having made a declaration under this Convention, other than a declaration authorized under Article 60, may withdraw it at anytime by notifying the Depository. Such withdrawal is to take effect on the first day of the month following the expiration of six months after the date of receipt of the notification by the Depository.
2. Notwithstanding the previous paragraph, this Convention shall continue to apply, as if no such withdrawal of declaration had been made, in respect of all rights and interests arising prior to the effective date of any such withdrawal.

## ARTICLE 59

### *Denunciations*

1. Any State Party may denounce this Convention by notification in writing to the Depository.

2. Any such denunciation shall take effect on the first day of the month following the expiration of twelve months after the date on which notification is received by the Depository.

3. Notwithstanding the previous paragraphs, this convention shall continue to apply, as if no such denunciation had been made, in respect of all rights and interests arising prior to the effective date of any such denunciation.

## ARTICLE 60

### *Transitional Provisions*

1. Unless otherwise declared by a Contracting State at anytime, the Convention does not apply to a pre-existing right or interest, which retains the priority it enjoyed under the applicable law before the effective date of this Convention.

2. For the Purpose of Article 1(v) and of determining priority under this Convention-

(a) “**effective date of this Convention**” means in relation to a debtor the time when this Convention enters into force or the time when the State in which the doctor is situated becomes a Contracting State whichever is the later; and

(b) the debtor is situated in a State where it has its centre of administration or, if it has no centre of administration, its place of business or, if it has more than one place of business, its principal place of business or if it has no place of business, its habitual residence.

3. A Contracting State may in its declaration under paragraph I specify a date, not earlier than three years after the date on which the declaration becomes effective, when this Convention and the Protocol will become applicable, for the purpose of determining priority, including the protection or any existing priority, to pre-existing rights or interests arising under an agreement made at a time when the debtor was situated in a State referred to in sub-paragraph (b) of the preceding paragraph but only to the extent and in the manner specified in its declaration.

## ARTICLE 61

### *Review Conferences, Amendments and Related Matters*

1. The Depository shall prepare reports yearly or at such other time as the circumstances may require for the States Parties as to the manner in which the international regimen established in this Convention has operated in practice. In preparing such reports, the Depository shall take into account the reports of the Supervisory Authority concerning the functioning of the international registration system.

2. At the request of not less than twenty-five per cent of the States Parties, Review Conferences of State Parties shall be convened from time to time by the Depository, in consultation with the supervisory Authority, to consider-

(a) the practical operation of this Convention and its effectiveness in facilitating the asset-base financing and leasing of objects covered by its terms;

(b) the judicial interpretation given to, and the application made of the terms of this Convention and regulations;

(c) the functioning of the international registration system, the performance of the Registrar and its oversight by the Supervisory Authority, taking into account the reports of the Supervisory Authority; and

(d) whether any modifications to this Convention or the arrangements relating to the International Registry are desirable.

**3.** Subject to paragraph 4, any amendment to this Convention shall be approved by at least a two-thirds majority of States Parties participating in the Conference referred to in the preceding paragraph and shall then enter into force in respect of States which have ratified, accepted or approved such amendment when ratified, accepted or approved by three States in accordance with the provisions of Article 49 relating to its entry into force.

**4.** Where the proposed amendment to this Convention is intended to apply to more than one category of equipments, such amendment shall also be approved by at least a two-thirds majority of States Parties to each Protocol that are participating in the Conference referred to in paragraph 2.

## ARTICLE 62

### *Depository and its Functions*

**1.** Instruments of ratification, acceptance, approval or accession shall be deposited with the International Institute for the Unification of Private Law (UNIDROIT), which is hereby designated the Depository.

**2.** The Depository shall-

(a) inform all Contracting States of-

(i) each new signature or deposit of an instrument of ratification acceptance, approval or accession, together with the date thereof;

(ii) the date of entry into force of this Convention;

(iii) each declaration made in accordance with this Convention, together with the date thereof;

(iv) the withdrawal or amendment of any declaration, together with the date thereof; and

(v) the notification of any denunciation of this Convention together with the date thereof and the date on which it takes effect;

(b) transmit certified true copies of this Convention to all Contracting States;

(c) provide the Supervisory Authority and the Registrar with a copy of each instrument of ratification, acceptance, approval or accession, together with the date of deposit thereof, of each declaration or withdrawal or amendment of a declaration and of each notification of denunciation, together with the date of notification thereof, so that the information contained therein is easily and fully available; and

(d) perform such other functions customary for depositories.

IN WITNESS WHEREOF the undersigned Plenipotentiaries, having been duly authorized, have signed this Convention.

DONE at Cape Town, this sixteenth day of November, two thousand and one, in a single original in the English, Arabic, Chinese, French, Russian and Spanish languages, all exists being equally authentic, such authenticity to take effect upon verification by the Joint Secretariat of the Conference under the authority of the President of the Conference within ninety days hereof as to the conformity of the texts with one another.

---

*B - Protocol to the Convention on International Interest in Mobile Equipment*

*On Matters specific to Aircraft Equipment.*

THE STATES PARTIES TO THIS PROTOCOL,

CONSIDERING it necessary to implement the Convention of International Interest in Mobile Equipment (hereinafter referred to as "the Convention") as it relates to aircraft equipment, in the light of the purposes set out in the preamble to the Convention;

MINDFUL of the need to adapt the Convention to meet the particular requirement of aircraft finance and to extend the sphere of application of the Convention to include contracts of sale of aircraft equipment;

MINDFUL of the principles and objectives of the Convention on International Civil Aviation, signed at Chicago on 7 December, 1944;

HAVE AGREED upon the following provisions relating to aircraft equipments:

CHAPTER 1

*Sphere of Application and General Provisions*

ARTICLE 1

Defined Terms

1. In this Protocol, except where the context otherwise requires, terms used in it have the meanings set out in the Convention.

2. In this Protocol the following terms are employed with the meanings set out below-

(a) **“aircraft”** means aircraft as defined for the purpose of the Chicago Convention which are either airframes with aircraft engines installed thereon or helicopters;

(b) **“aircraft engines”** means aircraft engines (other than those used in military, customs or police services) powered by jet propulsion or turbine or piston technology and

(i) in the case of jet propulsion aircraft engines, have at least 1750 lb of thrust or its equivalent; and

(ii) in the case of turbine-powered or piston-powered aircraft engines, have at least 550 rated take-off shaft horse power or its equivalent,

together with all modules and other installed, incorporated or attached accessories, parts and equipment and all data, manuals and records relating thereto;

(c) **“aircraft objects”** means airframes, aircraft engines and helicopters;

(d) **“aircraft register”** means a register maintained by a State or a common mark registering authority for the purposes of the Chicago Convention;

(e) **“airframes”** means airframes (other than those used in military, custom or police services that, when appropriate aircraft engines are installed thereon, are type certified by the competent aviation authority to transport;

(i) at least eight (8) persons including crew; or

(ii) goods in excess of 2750 kilograms,

(iii) together with all installed, incorporated or attached accessories, parts and equipment (other than aircraft engines), and all data, manuals and records relating thereto;

(f) **“authorized party”** means the party referred to in Article XIII (3);

(g) **“Chicago Convention”** means the Convention on International Civil Aviation, signed at Chicago on 7 December 1944, as amended, and its Annexes;

(h) **“common mark registering authority”** means the authority maintaining a register in accordance with Article 77 of the Chicago Convention as implemented by the Resolution adopted on 14 December, 1967 by the Council of the International Civil Aviation Organization on nationality and registration of aircraft operated by international operating agencies;

(i) **“de-registration of the aircraft”** means deletion or removal of the registration of the aircraft from its aircraft register in accordance with the Chicago Convention;

(j) **“guarantee contract”** means a contract entered into by a person as guarantor;

(k) **“guarantor”** means a person who, for the purpose of assuring performance of any obligations in favour of a creditor secured by a security agreement or under an agreement, gives or issues a suretyship or demand guarantee or a standby letter of credit or any other form of credit insurance;

(l) **“helicopters”** means heavier-than-air machines (other than those used in military, customs, or police services) supported in flight chiefly by the reactions of the air on one or more power-driven rotors on substantially vertical axis and which are type certified by the competent aviation authority to transport

(i) at least the (5) persons including crew; or

(ii) goods in excess of 450 kilograms,

together with all installed, incorporated or attached accessories, parts and equipment (including rotors), and all data manuals and records relating thereto;

(m) **“insolvency-related event”** means

(i) the commencement of the insolvency proceedings; or

(ii) the declared intention to suspend or actual suspension of payments by the debtor where the creditor’s right to institute insolvency proceedings against debtor or to exercise remedies under the Convention is prevented or suspended by law or State action;

(n) **“primary insolvency jurisdiction”** means the Contracting State in which the centre of the debtor’s main interest is situated, which for this purpose shall be deemed to be the place of the debtor’s statutory seat or, if there is none, the place where the debtor is incorporated or formed, unless proved otherwise :

(o) **“registry authority”** means the national authority or the common mark registering authority, maintaining an aircraft register in a Contracting State and responsible for the registration and de-registration of an aircraft in accordance with the Chicago Convention; and

(p) **“state of registry”** means in respect of an aircraft, the State on the national register of which an aircraft is entered or the State of location of the common mark registering authority maintaining the aircraft register.

## ARTICLE II

### *Application of Convention as regards Aircraft Objects*

1. The Convention shall apply in relation to aircraft objects as provided by the terms of this Protocol.

**2.** The Convention and this Protocol shall be known as the Convention on International Interests in Mobile Equipment as applied in aircraft objects.

### ARTICLE III

#### *Application of Convention to sales*

The following provisions of the Convention apply as if references to an agreement creating or providing for an international interest were references to a contract of sale and as if references to an international interest, the debtor and the creditor were references to a sale, a prospective sale, the seller and the buyer respectively:

Article 3 and 4;

Article 16 (1) (a);

Article 19 (4);

Article 20 (1) (as regards registration of a sale or a prospective sale);

Article 25 (2) (as regards a prospective sale); and

Article 30.

In addition, the general provisions of Article I, Article 5, Chapter IV to VII, Article 29 (other than Article 29 (3) which is replaced by Article XIV (1) and (2), Chapter X, Chapter XII (other than Article 43), Chapter XIII and Chapter XIV (other than Article 60) shall apply to contracts of sale and prospective sales.

### ARTICLE IV

#### *Sphere of Application*

**1.** Without prejudice to Article 3 (i) of the Convention, the Convention shall also apply in relation to a helicopter, or to an airframe pertaining to an aircraft, registered in an aircraft register of a Contracting State which is the State of registry, and where such registration is made pursuant to an agreement for registration of the aircraft it is deemed to have been effected at the time of the agreement.

**2.** For the purposes of the definition of “internal transaction’ in Article I of the Convention

(a) an airframe is located in the State of registry of the aircraft of which it is a part;

(b) an aircraft engine is located in the State of registry of the aircraft on which it is installed or, if it is not installed on an aircraft, where it is physically located; and

(c) a helicopter is located in its State of registry,

at the time of the conclusion of the agreement creating or providing for the interest.

3. The parties may, by agreement in writing, exclude the application of Article XI and, in their relations with each other, derogate from or vary the effect of any of the provisions of this Protocol except Article IX (2)-(4).

## ARTICLE V

### *Formalities, Effects and Registration of Contracts of Sale*

1. For the purposes of this Protocol, a contract of sale is one which-

is in writing;

relates to an aircraft object of which the seller has power to dispose; and

enables the aircraft object to be identified in conformity with this Protocol.

2. A contract of sale transfers the interest of the seller in the aircraft object to the buyer according to its terms.

3. Registration of contract of sale remains effective indefinitely. Registration of a prospective sale remains effective unless discharged or until expiry of the period, if any, specified in the registration.

## ARTICLE VI

### *Representative Capacities*

A person may enter into an agreement for a sale, and register an international interest in, or a sale of, an aircraft object, in an agency, trust or other representative - capacity. In such case, that person is entitled to assert rights and interests under the Convention.

## ARTICLE VII

### *Description of Aircraft Objects*

A description of an aircraft object that contains its manufacturer's serial number, the name of the manufacturer and its model designation is necessary and sufficient to identify the object for the purposes of Article 7 (c) of the Convention and Article V (1) (c) of this Protocol.

## ARTICLE VIII

### *Choice of Law*

1. This Article applies only where a Contracting State has made a declaration pursuant to Article XXX (1).

2. The parties to an agreement, or a contract of sale, or a related guarantee contract or subordination agreement may agree on the law which is to govern their contractual rights and obligation, wholly or in part.



**3.** Unless otherwise agreed, the reference in the preceding paragraph to the law chosen by the parties is to the domestic rules of law of the designated State or, where that State comprises several territorial units, to the domestic law of the designated territorial unit.

## CHAPTER II

### *Default Remedies, Priorities and Assignments*

## ARTICLE IX

### *Modification of Default Remedies Provisions*

**1.** In addition to the remedies specified in Chapter III of the Convention, the creditor may, to the extent that the debtor has at any time so agreed find in the circumstances specified in that Chapter-

(a) procure the de-registration of the aircraft; and

(b) procure the export and physical transfer of the aircraft object from the territory in which it is situated.

**2.** The creditor shall not exercise the remedies specified in the preceding paragraph without the prior consent in writing of the holder of any registered interest ranking in priority to that of the creditor.

**3.** Article 8 (3) of the Convention shall not apply to aircraft objects. Any remedy given by the Convention in relation to an aircraft object shall be exercised in a commercially reasonable manner. A remedy shall be deemed to be exercised in a commercially reasonable manner where it is exercised in conformity with a provision of the agreement except where such a provision is manifestly unreasonable.

**4.** A chargee giving ten or more working days' prior written notice of a proposed sale or lease to interested persons shall be deemed to satisfy the requirement of providing "reasonable prior notice" specified in Article 8 (4) of the Convention. The foregoing shall not prevent a chargee and a chargor or a guarantor from agreeing to a longer period of prior notice.

**5.** The registry in a contracting state shall, subject to any applicable safety laws and regulations, honour a request for de-registration and export if-

(a) the request is properly submitted by the authorized party under a recorded irrevocable de-registration and export request authorization; and

(b) the authorized party certifies to the registry authority, if required by that authority, that all registered interests ranking in priority to that of the creditor in whose favour the authorization has been issued have been discharged or that the holders of such interests have consented to the de-registration and export.

**6.** A chargee proposing to procure the de-registration and export of an aircraft under paragraph 1 otherwise than pursuant to a court order shall give reasonable prior notice in writing of the proposed de-registration and export to-

- (a) interested persons specified in Article 1(m) (i) and (ii) of the Convention; and
- (b) interested persons specified in Article 1(m) (iii) of the Convention who have given notice of their rights to the chargee within a reasonable time prior to the de-registration and export.

## ARTICLE X

### *Modification of Provisions regarding Relief pending Final Determination*

1. This Article applies only where a Contracting State has made a declaration under Article XXX (2) and to the extent stated in such declaration.
2. For the purposes of Article 13 (1) of the Convention, “speedy” in the context of obtaining relief means within such number of working days from the date of filing of the application for relief as is specified in a declaration made by the Contracting State in which the application is made.
3. Article 13 (1) of the Convention applies with the following being added immediately after subparagraph (d)-  
“(e) if at any time the debtor and the creditor specifically agree, sale and application of proceeds therefrom”,  
and Article 43 (2) applies with the insertion after the words “Article 13 (i) (d)” of it word “and (e)”.  
4. Ownership or any other interest of the debtor passing on a sale under the preceding paragraph is free from any other interest over which the creditor’s international interest has priority under the provisions of Article 29 of the Convention.  
5. The creditor and the debtor or any other interested person may agree in writing to exclude the application of Article 13 (2) of the Convention.
6. With regard to the remedies in Article IX (1)-
  - (a) they shall be made available by the registry authority and other administrative authorities, as applicable, in a Contracting State not later than five working days after the creditor notifies such authorities that the relief specified in Article (X)(I) is granted or, in the case of relief granted by a foreign court, recognised by a court of that Contracting State, and that the creditor is entitled to procure those remedies in accordance with the Convention; and
  - (b) the applicable authorities shall expeditiously cooperate with and assist the creditor in the exercise of such remedies in conformity with the applicable aviation safety laws and regulations.
7. Paragraphs 2 and 6 shall not affect any applicable aviation safety laws and regulations.

## ARTICLE XI

### *Remedies on Insolvency*

**1.** This Article applies only where a Contracting State that is the primary insolvency jurisdiction has made a declaration pursuant to Article XXX (3).

*Alternative A*

**2.** Upon the occurrence of an insolvency-related event, the insolvency administrator of the debtor, as applicable, shall, subject to paragraph 7, give possession of the aircraft object to the creditor no later than the earlier of-

the end of the waiting period; and

the date on which the creditor would be entitled to possession of the aircraft object if this Article did not apply.

**3.** For the purposes of this Article, the “waiting period” shall be the period specified in a declaration of the Contracting State which is the primary insolvency Jurisdiction.

**4.** References in this Article to the “insolvency administrator” shall be to that person in its official, not in its personal, capacity.

**5.** Unless and until the creditor is given the opportunity to take possession under paragraph 2-

(a) the insolvency administrator or the debtor, as applicable, shall preserve the aircraft object and maintain it and its value in accordance with the agreement; and

(b) the creditor shall be entitled to apply for any other forms of interim relief available under the applicable law.

**6.** Sub-paragraph (a) of the preceding paragraph shall not preclude the use of the aircraft object under arrangements designed to preserve the aircraft object and maintain it and its value.

**7.** The insolvency administrator or the debtor, as applicable, may retain possession of the aircraft object where, by the time specified in paragraph 2, it has cured all defaults other than a default constituted by the opening of insolvency proceedings and has agreed to perform all future obligations under the agreement. A second waiting period shall not apply in respect of a default in the performance of such future obligations.

**8.** With regards to the remedies in Article IX (1)-

(a) they shall be made available by the registry authority and the administrative authorities in a Contracting State, as applicable, not later than five working days after the date on which the creditor notifies such authorities that it is entitled to procure those remedies in accordance with the Convention; and

(b) the applicable authorities shall expeditiously cooperate with and assist the creditor in the exercise of such remedies in conformity with applicable aviation safety laws and regulations.

- 9.** No exercise of remedies permitted by the Convention or this Protocol may be prevented or delayed after the date specified in paragraph 2.
- 10.** No obligations of the debtor under the agreement may be modified without consent of the creditor.
- 11.** Nothing in the preceding paragraph shall be construed to affect the authority, if any, of the insolvency administrator under the applicable: law to terminate the cement.
- 12.** No rights or interests except for non-consensual rights or interests of a category covered by a declaration pursuant to Article 39 (1), shall have priority in insolvency proceedings over registered interests.
- 13.** The Convention as modified by Article IX of this Protocol shall apply to the exercise of any remedies under this Article.

#### Alternative B

- 2.** Upon the occurrence of an insolvency-related event, the insolvency administrator or the debtor, as applicable, upon the request of the creditor, shall give notice to the creditor within the time specified in a declaration of a Contracting State pursuant to Article XXX (3) whether it will-
  - (a) cure all defaults other than a default constituted by the opening of insolvency, proceedings and agree to perform all future obligations, under the agreement related transaction documents; or
  - (b) give the creditor the opportunity to take possession of the aircraft in accordance with the applicable law.
- 3.** The applicable law referred to in sub-paragraph (b) of the preceding paragraph may permit the court to require the taking of any additional step or the provision of any additional guarantee.
- 4.** The creditor shall provide evidence of its claims and proof that its international interest has been registered.
- 5.** If the insolvency administrator or the debtor, as applicable, does not give notice in conformity with paragraph 2, or when the insolvency administrator or the debtor has declared that it will give the creditor the opportunity to take possession of the aircraft object but fails to do so, the court may permit the creditor to take possession of the aircraft object upon such terms as the court may order and may require the taking of any additional step or the provision of any additional guarantee.
- 6.** The aircraft object shall not be sold pending a decision by a court regarding the claim and the international interest.

#### ARTICLE XII

##### *Insolvency Assistance*

- 1.** This article applies only where a Contracting State has made a declaration pursuant to Article XXX (1).

2. The courts of a Contracting State in which an aircraft object is situated shall in accordance with the law of the Contracting State, co-operate to the maximum extent possible with foreign courts and foreign insolvency administrators in carrying out provisions of Article XI.

#### ARTICLE XIII

##### *De-Registration and Export Request Authorization*

1. This Article applies only where a Contracting State has made a declaration pursuant to Article XXX (1).

2. Where the debtor has issued an irrevocable de-registration and export request authorization substantially in the form annexed to this Protocol and has submitted such authorization for recordation to the registry authority, that authorization shall be so recorded.

3. The person in whose favour the authorization has been issued (the “authorized party”) or its certified designee shall be the sole person entitled to exercise the remedies specified in Article IX (1) and may do so only in accordance with the authorization and applicable aviation safety laws and regulations. Such authorization may not be revoked by the debtor without the consent in writing of the authorized party. The registry authority shall remove an authorization from the registry at the request of the authorized party.

4. The registry authority and other administrative authorities in Contracting States shall expeditiously cooperate with and assist the authorized party in the exercise of the remedies specified in Article IX.

#### ARTICLE XIV

##### *Modification of Priority Provisions*

1. A buyer of an aircraft object under a registered sale acquires its interest in that object free from an interest subsequently registered and from an unregistered interest, even if the buyer has actual knowledge of the unregistered interest.

2. A buyer of an aircraft object acquires its interest in that object subject to an interest registered at the time of its acquisition.

3. Ownership of or another right or interest in an aircraft engine shall not be affected by its installation on or removal from an aircraft.

4. Article 29 (7) of the Convention applies to an item, other than an object, installed on an airframe, aircraft engine or helicopter.

#### ARTICLE XV

##### *Modification of Assignment Provisions*

Article 33 (1) of the Convention applies as if the following were added immediately after sub-paragraph (b)-

“ and

(c) the debtor has consented in writing, whether or not the consent is given in advance of the assignment or identifies the assignee.”.

## ARTICLE XVI

### *Debtor Provisions*

**1.** In the absence of a default within the meaning of Article 11 of the Convention, the debtor shall be entitled to the quiet possession and use of the object in accordance with the agreement as against-

(a) its creditor and the holder of any interest from which the debtor takes free pursuant to Article 29 (4) of the Convention or, in the capacity of buyer, Article XIV (1) of this Protocol, unless and to the extent that the debtor has otherwise agreed; and

(b) the holder of any interest to which the debtor’s right or interest is subject pursuant to Article 29 (4) of the Convention, or in the capacity of buyer, Article XIV (2) of this Protocol, but only to the extent, if any, that such holder has agreed.

**2.** Nothing in the Convention or this Protocol affects the liability of a creditor for any breach of the agreement under the applicable law in so far as that agreement relates to an aircraft object.

## CHAPTER III

### *Registry Provisions relating to International Interests in Aircraft Objects*

## ARTICLE XVII

### *The Supervisory Authority and the Registrar*

**1.** The Supervisory Authority shall be the international entity designated by a Resolution adopted by the Diplomatic Conference to Adopt a Mobile Equipment Convention and an Aircraft Protocol.

**2.** Where the international entity referred to in the preceding paragraph is not able and willing to act as Supervisory Authority, a Conference of Signatory and Contracting States shall be convened to designate another Supervisory Authority.

**3.** The Supervisory Authority and its officers and employees shall enjoy such immunity from legal and administrative process as is provided under the rules applicable to them as an international entity or otherwise.

**4.** The Supervisory Authority may establish a commission of experts, from among persons nominated by Signatory and Contracting States and having the necessary, qualifications and experience, and entrust it with the task of assisting the Supervisory Authority in the discharge of its functions.

5. The first Registrar shall operate the International Registry for a period of five years from the date of entry into force of this Protocol. Thereafter, the Registrar shall be appointed or reappointed at regular five-yearly intervals by the Supervisory Authority.

#### ARTICLE XVIII

##### First Regulations

The first regulations shall be made by the Supervisory Authority so as to take effect upon the entry into force of this Protocol.

#### ARTICLE XIX

##### *Designated Entry Points*

1. Subject to paragraph 2, a Contracting State may at any time designate an entity or entities in its territory as the entry point or entry points through which there shall or may be transmitted to the International Registry information required for registration other than registration of a notice of a national interest or a right or interest under Article 40 in either case arising under the laws of another State.
2. A designation made under the preceding paragraph may permit, but not compel, use of a designated entry point or entry points for information required for registrations in respect of aircraft engines.

#### ARTICLE XX

##### *Additional Modifications to Registry Provisions*

1. For the purposes of Article 19 (6) of the Convention, the search criteria for an aircraft object shall be the name of its manufacturer, its manufacturer's serial number and its model designation, supplemented as necessary to ensure uniqueness. Such supplementary information shall be specified in the regulations.
2. For the purposes of Article 25 (2) of the Convention and in the circumstances there described, the holder of a registered prospective international interest or a registered prospective assignment of an international interest or the person in whose favour a prospective sale has been registered shall take such steps as are within its power to procure the discharge of the registration no later than five working days after receipt of the demand described in such paragraph.
3. The fees referred to in Article 17 (2) (h) of the Convention shall be determined so as to recover the reasonable costs of establishing, operating and regulating the International Registry and the reasonable costs of the Supervisory Authority associated with the performance of the functions, exercise of the powers, and discharge of the duties contemplated by Article 17 (2) of the Convention.

4. The centralised functions of the International Registry shall be operated and administered by the Registrar on a twenty-four hours basis. The various entry points shall be operated at least during working hours in their respective territories.

5. The amount of the insurance or financial guarantee referred to in Article 28(4) of the Convention shall, in respect of each event, not be less than the maximum value of an aircraft object as determined by the Supervisory Authority.

6. Nothing in the Convention shall preclude the Registrar from procuring insurance or a financial guarantee covering events for which the Registrar is not liable under Article 28 of the Convention.

#### CHAPTER IV

##### Jurisdiction

#### ARTICLE XXI

##### *Modification of Jurisdiction Provisions*

For the purposes of Article 43 of the Convention and subject to Article 42 of the Convention, a court of a Contracting State also has jurisdiction where the object is a helicopter or an airframe pertaining to an aircraft, for which that State is the State of registry.

#### ARTICLE XXII

##### *Waiver of Sovereign Immunity*

1. Subject to paragraph 2, a waiver of sovereign immunity from jurisdiction of courts specified in Article 42 or Article 43 of the Convention or relating to enforcement of rights and interests relating to an aircraft object under the Convention shall be binding and, if the conditions to such jurisdiction or enforcement have been satisfied shall be effective to confer jurisdiction and permit enforcement, as the case may be.

2. A waiver under the preceding paragraph must be in writing and contain a description of the aircraft object.

#### CHAPTER V

##### *Relationship with other Conventions*

#### ARTICLE XXIII

##### *Relationship with the Convention on the International Recognition of Rights in Aircraft*

The Convention shall, for a Contracting State that is a party to the *Convention on the International Recognition of Rights in Aircraft*, signed at Geneva on 19 June, 1948 supersede that Convention as it relates to aircraft, as defined in this Protocol, and to aircraft objects. However, with respect to rights or



interests not covered or affected by the present Convention, the Geneva Convention shall not be superseded.

#### ARTICLE XXIV

##### *Relationship with the Convention for the Unification of Certain Rules relating to the Precautionary Attachment of Aircraft*

1. The Convention shall, for a contracting State that is a Party to the *Convention for the Unification of Certain Rules Relating to the Precautionary Attachment of Aircraft*, signed at Rome on 29 May, 1933 supersede that Convention as it relates to aircraft, as defined in this Protocol.
2. A Contracting State Party to the above Convention may declare, at the time of ratification, acceptance, approval of, or accession to this Protocol, that it will not apply to this Article.

#### ARTICLE XXV

##### *Relationship with the UNIDROIT Convention on International Financial Leasing*

The Convention shall supersede the UNIDROIT Convention on International Financial Leasing, signed at Ottawa on 28 May, 1988 as it relates to aircraft objects.

#### CHAPTER VI

##### *Final Provisions*

#### ARTICLE XXVI

##### *Signature, Ratification, Acceptance, Approval or Accession*

1. This Protocol shall be open for signature in Cape Town on 16 November 2001 by States participating in the Diplomatic Conference to Adopt a Mobile Equipment and an Aircraft Protocol held at Cape Town from 29 October to 16 November, 2001. After 16 November, 2001, this Protocol shall be open to all States for signature at the Headquarters of the International Institute for the Unification of the Private Law (UNIDROIT) in Rome until it enters into force in accordance with Article XXVIII.
2. This Protocol shall be subject to ratification, acceptance or approval by States which have signed it.
3. Any State which does not sign this Protocol may accede to it at anytime.
4. Ratification, acceptance, approval or accession is effected by the deposit of a formal instrument to that effect with the Depository.
5. A State may not become a Party to this Protocol unless it is or becomes also a Party to the Convention.

#### ARTICLE XXVII

### *Regional Economic Integration Organizations*

- 1.** A Regional Economic Integration Organization which is constituted by sovereign States and has competence over certain matters governed by this Protocol may similarly sign, accept, approve, or accede to this Protocol. The Regional Economic Integration Organization shall in that case have the rights and obligations of Contracting State, to the extent that Organization has competence over matters governed by this Protocol. Where the number of Contracting States is relevant in the Protocol, the Regional Economic Integration Organization shall not count as Contracting State in addition to its Member States which are Contracting States.
- 2.** The Regional Economic Integration Organization shall, at the time of signature, acceptance, approval or accession, make a declaration to the Depository specifying the matters governed by this Protocol in respect of which competence has been transferred to that Organization by its Member States. The Regional Economic Integration Organization shall promptly notify the Depository of any changes to the distribution of competence, including new transfers of competence, specified in the declaration under this paragraph.
- 3.** Any reference to a “Contracting State” or “Contracting States” or “State Party” or “States Parties” in this Protocol applies equally to Regional Economic Integration Organization where the context so requires.

### ARTICLE XXVIII

#### *Entry into Force*

- 1.** This Protocol enters into force on the first day of the month following the expiration of three months after the date of the deposit of the eight instruments of ratification, acceptance, approval or accession, between the States which have deposited such instruments.
- 2.** For other States this Protocol enters into force on the first day of the month following the expiration of three months after the date of the deposit of its instrument of ratification, acceptance, approval or accession.

### ARTICLE XXIX

#### *Territorial Units*

- 1.** If a Contracting State has units in which different systems of law are applicable in relation to the matters dealt with in this Protocol, it may, at the time of ratification, acceptance, approval or accession, declare that this Protocol is to extend to all its territorial units or only to one or more of them and may modify its declaration by submitting another declaration at any time.
- 2.** Any such declaration shall state expressly the territorial units to which this Protocol applies.
- 3.** If a Contracting State has not made any declaration under paragraph 1, this Protocol shall apply to all territorial units of that State.

4. Where a Contracting State extends this Protocol to one or more of its territorial units, declarations permitted under this Protocol may be made in respect of each such territorial unit, and the declarations made in respect of one territorial unit may be different from those made in respect of another territorial unit.

5. If by virtue of a declaration under paragraph I, this protocol extends to one or more territorial units of a Contracting State-

(a) the debtor is considered to be situated in a Contracting State only if it is incorporated or formed under a law in force in a territorial unit to which the Convention and this Protocol apply or if it has its registered office or statutory seat, centre of administration, place of business or habitual residence in a territorial unit to which the Convention and this Protocol apply;

(b) any reference to the location of the object in a Contracting State refers to the location of the object in a territorial unit to which the Convention and this Protocol apply; and

(c) any reference to the administrative authorities in that Contracting State shall be construed as referring to the administrative authorities having jurisdiction in a territorial unit to which the Convention and this Protocol apply and any reference to the national register or to the registry authority in that Contracting State shall be construed as referring to the aircraft register in force or to the registry authority having jurisdiction in the territorial unit or units to which the Convention and this Protocol apply.

#### ARTICLE XXX

##### *Declaration relating to Certain Provisions*

1. A Contracting State may, at the time of ratification, acceptance, approval of, or accession to this Protocol, declare that it will apply any one or more of Articles VIII, XII and XIII of this Protocol.

2. A Contracting State may, at the time of ratification, acceptance, approval of, or accession to this Protocol, declare that it will apply Article X of this Protocol, wholly or in part. If it so declares with respect to Article X(2), it shall specify the time period required thereby.

3. A Contracting State may, at the time of ratification, acceptance, approval of, or accession to this Protocol, declare that it will apply the entirety of Alternative A, or the entirety of Alternative B of Article XI and, if so, shall specify the types of insolvency proceedings, if any, to which it will apply Alternative A and the types of insolvency proceedings, if any, to which it will apply Alternative B. A Contracting State making a declaration pursuant to this paragraph shall specify the time-period required by Article XI.

4. The courts of Contracting States shall apply Article XI in conformity with the declaration made by the Contracting State which is the primary insolvency jurisdiction.

5. A Contracting State may, at the time of ratification, acceptance, approval of, or accession to this Protocol, declare that it will not apply the provisions of Article XXI wholly or in part. The declaration shall

specify under which conditions the relevant Article will be applied, in case it will be applied partly, or otherwise which other forms of interim relief will be applied.

#### ARTICLE XXXI

##### *Declarations under the Convention*

Declarations made under the Convention, including those made under Article 39,40,50,53,54,55,57,58, and 60 of the Convention, shall be deemed to have also been made under this Protocol unless stated otherwise.

#### ARTICLE XXXII

##### *Reservations and Declarations*

1. No reservations may be made to this Protocol but declarations authorized by Articles XXIV, XXIX, XXX, XXXI, XXXIII, and XXXIV may be made in accordance with these provisions.
2. Any declaration or subsequent declaration or any withdrawal of a declaration made under this Protocol shall be notified in writing to the Depository.

#### ARTICLE XXXIII

##### *Subsequent Declarations*

1. A State Party may make a subsequent declaration, other than a declaration made in accordance with Article XXXI under Article 60 of the Convention, at any time after the date on which this Protocol has entered into force for it, by notifying the Depository to that effect.
2. Any such subsequent declaration shall take effect on the first day of the month following the expiration of six months after the date of receipt of the notification by the Depository. Where a longer period for that declaration to take effect is specified on the notification, it shall take effect upon the expiration of such longer period after receipt of the notification by the Depository.
3. Notwithstanding the previous paragraphs, the Protocol shall continue to apply, as if no such subsequent declarations have been made in respect of all rights and interests arising prior to the effective date of any such subsequent declaration.

#### ARTICLE XXXIV

##### *Withdrawal of Declarations*

1. Any State Party having made a declaration under this Protocol, other than a declaration made in accordance with Article XXXI under Article 60 of the Convention, may withdraw it at any time by notifying the Depository. Such withdrawal is to take effect on the first day of the month following the expiration of six months after the date of receipt of the notification by the Depository.

**2.** Notwithstanding the previous paragraph, this Protocol shall continue to apply, as if no such withdrawal of declaration had been made, in respect of all rights and interest arising prior to the effective date of any such withdrawal.

#### ARTICLE XXXV

##### *Denunciations*

- 1.** Any State Party may denounce this Protocol by notification in writing to the Depository.
- 2.** Any such denunciation shall take effect on the first day of the month following the expiration of twelve months after the date of receipt of the notification by the Depository.
- 3.** Notwithstanding the previous paragraphs, this Protocol shall continue to apply, as if no such denunciation had been made, in respect of all rights and interests arising prior to the effective date of any such denunciation.

#### ARTICLE XXXVI

##### *Review Conferences, Amendments and Related Matters*

- 1.** The Depository, in consultation with the Supervisory Authority, shall prepare reports yearly, or at such time as the circumstances may require, for the States Parties as to the manner in which the international regime established in the Convention as amended by this Protocol has operated in practice. In preparing such reports, the Depository shall take into account the reports of the Supervisory Authority concerning the functioning of the international registration system.
- 2.** At the request of not less than twenty-five percent of the States Parties, Review Conferences of the States Parties shall be convened from time to time by the Depository, in consultation with the Supervisory Authority, to consider-
  - (a) the practical operation of the Convention as amended by this Protocol and its effectiveness in facilitating the asset-based financing and leasing of the objects covered by its terms;
  - (b) the judicial interpretation given to, and the application made of the terms of this Protocol and the regulations;
  - (c) the functioning of the international registration system, the performance of the Registrar and its oversight by the Supervisory Authority, taking into account the reports of the Supervisory Authority; and
  - (d) whether any modifications to this Protocol or the arrangements relating to the International Registry are desirable.
- 3.** Any amendment to this Protocol shall be approved by at least a two-third majority of States Parties participating in the Conference referred to in the preceding paragraph and shall then enter into force in respect of States which have ratified, accepted or approved such amendment when it has been ratified,

accepted or approved by eight States in accordance with the Provisions of Article XXVIII relating to its entry into force.

## ARTICLE XXXVII

### *Depository and its Functions*

1. Instruments of ratification, acceptance, approval or accession shall be deposited with the International Institute for the Unification of Private Law (UNIDROIT), which is hereby designated the Depository.

2. The Depository shall-

(a) inform all Contracting States of-

(i) each new signature or deposit of an instrument of ratification, acceptance, approval or accession, together with the date thereof;

(ii) the date of entry into force of this Protocol;

(iii) each declaration made in accordance with this Protocol, together with the date thereof;

(iv) the withdrawal or amendment of any declaration, together with the date thereof; and

(v) the notification of any denunciation of this Protocol together with the date thereof and the date on which it takes effect;

(b) transmit certified true copies of this Protocol to all Contracting States;

(c) provide the Supervisory Authority and the Registrar with a copy of each instrument of ratification, acceptance, approval or accession, together with date of deposit thereof, of each declaration or withdrawal or amendment of a declaration and of each notification of denunciation, together with the date of notification thereof, so that the information contained therein is easily and fully available; and

(d) perform such other functions customary for depositories.

IN WITNESS WHEREOF the undersigned Plenipotentiaries, having been duly authorized, have signed this Protocol.

DONE at Cape Town, this sixteenth day of November, two thousand and one, in a single original in the English, Arabic, Chinese, French, Russian and Spanish languages, all texts being equally authentic, such authenticity to take effect upon verification by the joint Secretariat of the Conference under the authority of the President of the Conference within ninety days hereof as to the conformity of the texts with one another.

ANNEX

FORM OF IRREVOCABLE DE-REGISTRATION AND

EXPORT REQUEST AUTHORISATION

Annex Referred to in Article XIII

(Insert Date)

To: (Insert Name of Registry Authority)

Re: Irrevocable De-Registration and Export Request Authorization

The undersigned is the registered [operator] (owner)\* of the [insert the airframe/ helicopter manufacturer's name and model number] bearing manufacturer's

\* Select the term that reflect the relevant nationality registration criterion.

serial number [insert manufacturer's serial number] and registration [number] [mark] [insert registration number/mark] (together with all installed, incorporated or attached accessories, parts and equipment, the "aircraft").

This instrument is an irrevocable de-registration and export request authorization issued by the undersigned in favour of [insert name of creditor] ("the authorized party") under the authority of Article XIII of the Protocol to the Convention on International Interests in Mobile Equipment on Matters specific to Aircraft Equipment. In accordance with that Article, the undersigned hereby requests-

(i) recognition that the authorized party or the person it certifies as its designee is the sole person entitled to -

(a) procure the deregistration of the aircraft from the [insert name of aircraft register] maintained by the [insert name of registry authority] for the purposes of Chapter III of the *Convention on International Civil Aviation*, signed at Chicago, on 7 December, 1944; and

(b) procure the export and physical transfer of the aircraft from (insert name of country); and

(ii) confirmation that the authorized party or the person it certifies as designee may take the action specified in clause (i) above on written demand without the consent of the undersigned and that, upon such demand, the authorities in [insert name of country] shall co-operate with the authorized party with a view to the speedy completion of such action.

The rights in favour of the authorized party established by this instrument may not be revoked by the undersigned without the written consent of the authorized party.

Please acknowledge your agreement to this request and its terms by appropriate notation in the space provided below and lodging this instrument in (insert name of registry authority).

[insert name of operator/owner]

---

---

agreed to and lodged this

by: [insert name of signatory]

[insert date]

its: [insert title of signatory]

---

[insert relevant notational details]

---

## SIXTH SCHEDULE

[Section 3 (4).]

### *Supplementary Provisions relating to the Board, etc*

1. Subject to this Act and section 27 of the Interpretation Act, Cap 192 LFN 1990, the Board may make standing orders regulating its proceedings or those of any of its committees.
2. At every meeting of the Board, the Chairman shall preside and in his absence the members present at the meeting shall appoint one of their members to preside at the meeting.
3. The quorum at a meeting of the Board shall consist of the Chairman or, in an appropriate case, the person presiding at the meeting pursuant to paragraph 2 of this Schedule, and three other members of the Board, two of whom shall be *ex officio* members.
4. The Board shall, for the purposes of this Act, meet not less than three times in each year and, subject thereto, the Board shall meet whenever it is summoned by the Chairman, and if required to do so, by notice given to him by not less than four other members, he shall summon a meeting of the Council to be held within 14 days from the date on which the notice is given.
5. Where the Board desires to obtain the advice of any person on a particular matter, the Board may co-opt him to the Board for such period as it deems fit, but a person who is a member by virtue of this subparagraph shall not be entitled to vote at any meeting of the Board and shall not count towards a quorum.

### *Committees*

6.(1) Subject to its standing orders, the Board may appoint such number of standing and ad-hoc Committee as it thinks fit to consider and report any matter with which the authority is concerned.

(2) A committee appointed under this paragraph shall-

(a) consist of such number of persons (not necessarily members of the Board) as may be determined by the Board, and a person, other than a member of the Board, shall hold office on the committee in accordance with the terms of his appointment; and

(b) be presided over by a member of the Board.



(3) The quorum of any committee set up by the Board shall be as may be determined by the Board.

(4) A decision of a committee of the Board shall be of no effect until it is confirmed by the Board.

*Miscellaneous*

**7.** The Fixing of the seal of the Authority shall be authenticated by the signature of the Chairman, the Director-General or any other person generally or specifically authorized by the Board to act for that purpose.

**8.** Any contract or instrument which, if made by a person not being a body corporate, would not be required to be under seal may be made or executed on behalf of the Authority by the Director-General or by any other person generally or specially authorized by the Board to act for that purpose.

**9.** Any document purporting to be a contract, instrument, or other document duly signed or sealed on behalf of the Authority shall be received in evidence as shall, unless the contrary is proved, be presumed without further proof to have been signed or sealed.

**10.** The validity of any proceedings of the Board or of any of its committee shall not be affected by;

(a) any vacancy in the membership of the Board, or Committee; or

(b) any defect in the appointment of a member of the Board or Committee; or

(c) reason that any person not entitled to do so took part in the proceedings of the Board or Committee.

**11.** A member of the Board or a Committee who has a personal interest in any contract or arrangement entered into or proposed to be considered by the Board or such Committee shall forthwith disclose his interest to the Board and shall not vote on any question relating to the contract or arrangement.

**12.** No member of the Board shall be personally liable for any act or omission done or made in good faith while engaged in the business of the Authority.

---

## **CHAPTER C13**

### **CIVIL AVIATION ACT**

#### **SUBSIDIARY LEGISLATION**

---

##### *List of Subsidiary Legislation*

1. Civil Aviation (Air Transport) (Licensing) Regulations.
  2. Civil Aviation (Fees) Regulations.
  3. Civil Aviation (Aircraft Performance) Regulations.
  4. Civil Aviation (Births, Deaths, and Missing Persons) Regulations.
  5. Civil Aviation Rules of the Air and Air Traffic Control.
  6. Civil Aviation (Investigation of Accidents) Regulations.
  7. Civil Aviation (Air Navigation) Regulations.
- 

#### **CIVIL AVIATION (AIR TRANSPORT) (LICENSING) REGULATIONS**

##### **ARRANGEMENT OF REGULATIONS**

###### **PART I**

###### *General*

###### **REGULATION**

1. Short title.
2. Interpretation.

###### **PART II**

###### *Licences for scheduled journeys*

3. Application of Part II.
4. Restriction of operation of aircraft without licence.
5. Power of the Minister to grant a licence.
6. Application of First Schedule.
7. Period of licence.
8. Power of the Minister to grant a provisional licence.
9. Publication of the decisions of the Minister.
10. Revocation or suspension of licence.
11. Surrender of licence.

###### **PART III**

###### *Permits for flights other than scheduled journeys*

12. Application of Part III.

13. Restriction of the operation of aircraft without a permit.
14. Power of the Minister to grant a permit.
15. Application of the Third Schedule.
16. Revocation or suspension of permits.

#### PART IV

##### *General provisions*

17. Conditions of licences or permits.
18. Licence or permit not to be transferred.
19. Publication of applications.
20. Objections.
21. Matters to be considered before the granting of licence or permit.
22. Attachment of conditions.
23. Holder of licence to make returns.
24. No right to continuance of benefits of licence or permit.
25. Fees payable for a licence or permit.
26. Reference to include provisional licence.
27. Offences by officers of the body corporate.

#### SCHEDULES

##### FIRST SCHEDULE

##### *Applications for licences*

##### SECOND SCHEDULE

##### *Publication of decisions*

##### THIRD SCHEDULE

##### *Applications for permits*

---

## **CIVIL AVIATION (AIR TRANSPORT) (LICENSING) REGULATIONS**

under section 24

[Commencement.]

[1st December, 1965]

#### PART I

##### *General*

### **1. Short title**

These Regulations may be cited as the Civil Aviation (Air Transport) (Licensing) Regulations.

## **2. Interpretation**

(1) In these Regulations, unless the context otherwise requires-

"**air service**" means any service performed by any aircraft for hire or reward:

Provided that a member of a club carried in an aircraft belonging to the club for the purpose of instruction in flying shall not, if the instructor is also a member of the club, be deemed to be carried for hire or reward, notwithstanding that payment is made for such instruction or carriage;

"**licence**" means a licence granted under regulation 5 of these Regulations;

"**Minister**" means the Minister charged with responsibility for matters relating to civil aviation;

"**permit**" means a permit granted under regulation 14 (1) of these Regulations;

"**provisional licence**" means a licence granted under regulation 8 of these Regulations;

"**provisional permit**" means a permit granted under regulation 14 (2) of these Regulations;

"**Federal Gazette**" means the Official *Gazette* of the Federal Republic of Nigeria;

"**scheduled journey**" means one of a series of journeys which are undertaken between the same two places and which together amount to a systematic service operated in such a manner that the benefits thereof are available to members of the public from time to time seeking to take advantage of it.

(2) The Interpretation Act shall apply for the purpose of the interpretation of these Regulations as it applies for the purpose of the interpretation of an Act of the National Assembly.

[Cap. 123.]

### **PART II**

#### **Licences for scheduled journeys**

### **3. Application of Part II**

This Part shall not apply to the carriage of passengers, mail or cargo by air for hire or reward upon journeys other than scheduled journeys.

### **4. Restriction of operation of aircraft without a licence**

(1) Subject to the provisions of these Regulations, it shall not be lawful for any person to use any aircraft in Nigeria for the carriage of passengers, mail or cargo for hire or reward upon any scheduled journey between two places of which at least one is in Nigeria, except under and in accordance with the provisions of a licence or a provisional licence.

(2) Any person who uses any aircraft in contravention of the provisions of this regulation shall be liable in the case of a first offence to a fine not exceeding one thousand naira or to imprisonment for a term not exceeding three months or to both such fine and imprisonment, and in the case of a second or subsequent offence to a fine not exceeding ten thousand naira or to imprisonment for a term not exceeding two years or to both such fine and such imprisonment.

(3) Nothing in this regulation shall restrict the right of a designated Nigerian Airline or any air transport undertaking having its principal place of business in any country outside Nigeria, to provide transport for passengers, mail or cargo-

(a) in accordance with the terms of any agreement for the time being in force between the Government of the Federal Republic of Nigeria and the government of that country; or

(b) in accordance with the terms of any permission granted by the Minister pending the completion of negotiations for such an agreement as aforesaid.

#### **5. Power of the Minister to grant a licence**

(1) The Minister may grant to any person applying therefore a licence to use in Nigeria, for the carriage of passengers, mail or cargo for hire or reward, such aircraft, on such scheduled journeys, subject to such conditions as may be specified respectively in the licence.

(2) It shall be a condition of every licence that-

(a) the holder of the licence and any person having a financial interest in the business of the holder of the licence shall refrain from stipulating that any other person shall-

(i) refuse booking facilities to any other holder of a licence; or

(ii) shall afford such facilities to such other holder only on terms less favourable to that holder than the terms which are enjoyed by the first-mentioned holder;

(b) the holder of the licence shall perform all such reasonable services as the Minister may from time to time require in regard to the conveyance of mails (and of any person who may be in charge thereof) upon journeys made under the licence; that the remuneration for any such services shall be such as may be from time to time determined by agreement between the Minister and the holder of the licence; and that any dispute, difference or question which may arise as to the remuneration to be paid to the licence holder in respect of such services or as to the rights, duties or liabilities of the licence holder or the Minister in relation to any of the matters referred to in this subparagraph (b) shall in default of agreement be referred to arbitration in pursuance of the provisions of the Arbitration and Conciliation Act, or of any enactment modifying or replacing the same.

[Cap. A18.]

(3) Any licence may if the Minister thinks fit be limited to the carriage of passengers or to the carriage of cargo.

## **6. Application of First Schedule**

The provisions set out in the First Schedule to these Regulations shall have effect in relation to applications for licences.

## **7. Period of licence**

The Minister may grant licences to remain in force for such period as he may in each case determine, commencing on the date on which the licence is expressed to take effect:

Provided that if, on the date of the expiration of a licence (herein referred to as the expiring licence), an application to the Minister by the holder of the expiring licence is pending for the grant of a new licence in substitution for or in continuance of the expiring licence, the expiring licence shall continue in force until such application is granted or refused.

## **8. Power of the Minister to grant a provisional licence**

(1) The Minister may if he thinks fit, pending the determination of an application for a licence, or a negotiation for a bilateral agreement, grant to the applicant a provisional licence to use in Nigeria for the carriage of passengers, mail or cargo for hire or reward such aircraft, on such scheduled journeys (being journeys of a kind to which the application relates), subject to such conditions as may be specified respectively in such provisional licence.

(2) Any provisional licence so granted shall remain in force until the application is determined but on such determination shall come to an end.

(3) Any provisional licence may, if the Minister thinks fit, be limited to the carriage of passengers or to carriage of cargo.

## **9. Publication of decision of the Minister**

The Minister shall cause to be published in the manner prescribed in the Second Schedule to these Regulations such particulars of his decisions on applications for licences and of his decisions to revoke or suspend a licence as are prescribed in the said Second Schedule.

## **10. Revocation or suspension of licence**

(1) Subject to the provisions of this regulation, the Minister may revoke or suspend a licence if-

- (a) the holder of the licence has, since the licence was granted, been convicted of an offence against regulation 4 or 13 of these Regulations; or
- (b) where the holder of the licence is a body corporate, any officer of that body corporate, has, since the licence was granted, been convicted, in his capacity as such officer, of an offence against regulation 4 or 13 of these Regulations; or
- (c) any condition subject to which the licence was granted has not been complied with.

(2) If the Minister proposes to revoke or suspend any licence on the ground specified in paragraph (1) (c) of this regulation, the Minister shall-

(a) first give written notice to the holder of the licence specifying the conditions which it is alleged have not been complied with, and the occasions on which and the respects in which it is alleged that the same were not complied with;

(b) not proceed to revoke or suspend the licence until after the expiration of 28 days from the date of such notice;

(c) not in any event revoke or suspend the licence unless he is satisfied, after holding an enquiry if the holder of the licence within seven days after the date of the aforesaid notice by written notice requires the Minister to hold such enquiry, that, by reason of the number of occasions on which such conditions or any of them, have not been complied with or the circumstances that any non-compliance with any such condition was wilful, the licence ought to be revoked or suspended.

(3) The expression "**officer**" in this regulation means a director, general manager, secretary or other similar officer, and includes any person who purports to act in any such capacity.

#### **11. Surrender of licence**

A licence may at any time be surrendered by the holder to the Minister for cancellation; and if, during the currency of a licence, the holder applies to the Minister for a new licence in substitution for the current licence, he shall, if a new licence is granted, surrender the current licence for cancellation on the date from which the new licence is expressed to take effect.

### **PART III**

#### *Permits for flights other than scheduled journeys*

#### **12. Application of Part III**

This Part shall not apply to the carriage of passengers, mail or cargo by air for hire or reward on scheduled journeys.

#### **13. Restriction of the operation of air-craft without permit**

(1) Subject to the provisions of these Regulations, it shall not be lawful for any person to use in Nigeria any aircraft for the provision of any air service except under, and in accordance with the conditions of, a permit or a provisional permit.

(2) Any person who uses any aircraft in contravention of the provisions of this regulation shall be liable on conviction, in the case of a first offence, to a fine not exceeding five hundred naira or to imprisonment for a term not exceeding three months or to both such fine and imprisonment, and, in the case of a second or subsequent offence, to a fine not exceeding four thousand naira or to imprisonment for a term not exceeding two years or to both such fine and such imprisonment.

(3) Nothing in this regulation shall affect the right of any person to use in Nigeria an aircraft registered in a State (other than Nigeria) which is for the time being a party to the Convention on Civil Aviation signed at Chicago on 7 December, 1944, for the sole purpose of the carriage of passengers, none of whom are taken on or discharged from the aircraft in Nigeria or the carriage of cargo or mail, none of which is taken on or discharged from the aircraft in Nigeria.

#### **14. Power of the Minister to grant a permit**

(1) The Minister may grant to any person applying therefore, a permit to use in Nigeria such aircraft for the provision of such air services (other than services such as are referred to in paragraph (1) of regulation 4 of these Regulations), for such period and on such conditions as may be specified respectively in the permit.

(2) The Minister may if he thinks fit, pending the determination of an application for a permit, grant to the applicant a provisional permit to use in Nigeria such aircraft, for the provision of such air services (being services of a kind to which the application relates and in respect of which a permit can be granted under paragraph (1) of this regulation), subject to such conditions as may be specified respectively in the provisional permit; and any provisional permit so granted shall remain in force until the application is determined but, on such determination, shall come to an end.

#### **15. Application of the Third Schedule**

The provisions set out in the Third Schedule to these Regulations shall have effect in relation to an application for permits.

#### **16. Revocation or suspension of permits**

(1) The Minister may revoke or suspend any permit if-

(a) the holder of the permit has, since the permit was granted, been convicted of an offence against regulation 4 or 13 of these Regulations; or

(b) where the holder of the permit is a body corporate, any officer of that body corporate has, since the permit was granted, been convicted, in his capacity as such officer, of an offence against regulation 4 or 13 of these Regulations; or

(c) the holder of the permit has failed to comply with any condition subject to which the permit was granted.

(2) The expression "**officer**" in this regulation means a director, general manager, secretary or other similar officer and includes any person who purports to act in any such capacity.

### **PART IV**

#### *General provisions*

#### **17. Condition of licences or permits**



It shall be a condition of every licence or permit that the requirements of any law or instrument having the force of law, for the time being in force in Nigeria, relating to air navigation or air transport shall be complied with at all times during the currency of the licence or permit in connection with all journeys made under the licence or permit.

#### **18. Licence or permit not to be transferred**

A licence or permit shall not be capable of being transferred or assigned:

Provided that in the event of the death, incapacity, bankruptcy, sequestration or liquidation of the holder of a licence or permit, or of the appointment of a receiver or manager or trustee in relation to the business of the holder of a licence or permit, the person for the time being carrying on that business shall, if within fourteen days of his commencing so to do he makes application to the Minister for a new licence or permit in respect of the services authorised by the existing licence or permit, be entitled to provide the air services authorised by the existing licence or permit subject to the conditions thereof, until the application is determined.

#### **19. Publication of applications**

(1) Subject to the provisions of this regulation, the Minister shall cause to be published in the *Gazette* a notice giving such particulars of any application for a licence or permit received by him as he may consider necessary, and specifying a date, not less than 28 days after the publication of the notice, by which any representations or objections may be made to the Minister, in the manner provided by regulation 20 of these Regulations, with respect to the application by any interested person and the Minister shall not proceed to determine any application until after the date so specified in relation thereto.

(2) If an application is made to the Minister for a licence or permit to remain in force for a period not exceeding thirty days and it appears to the Minister that it is in the public interest that such application should be determined with expedition the Minister may proceed to determine the application notwithstanding that paragraph (1) of this regulation has not been complied with; and in any such case the provisions of the said paragraph (1) shall not apply in relation to such application.

#### **20. Objections**

(1) Every representation or objection with regard to an application for a licence or a permit shall be in writing and must be signed by the objector, or, if the representation or objection is made by any corporate body it shall be signed by any person duly authorised in that behalf by such body.

(2) Every representation or objection shall state the specific grounds on which it is based and shall specify any conditions which it is desired should be attached to the licence or permit if granted.

#### **21. Matters to be considered before the granting of licence or permit**

The Minister shall, in determining any application for a licence or a permit, have regard generally to the desirability of co-ordinating and developing air services with the object of ensuring the most effective service to the public while avoiding uneconomic overlapping of services and to the interests of the public, including those of persons requiring or likely to require air services as well as those of persons providing such services, and shall in particular have regard to such of the following matters as may be appropriate having regard to the nature of the application-

- (a) the existing or potential need or demand for any air service proposed;
- (b) the existence of other air services in the area in or through which the proposed services are to be operated;
- (c) the degree of efficiency and regularity of the air services, if any, already provided in that area, whether by the applicant or by other operators;
- (d) the period for which such services have been operated by the applicant or by other operators;
- (e) the extent to which it is probable that the applicant will be able to provide a satisfactory service in respect of safety, continuity, regularity of operation, frequency, punctuality, reasonableness of charges and general efficiency;
- (f) the financial resources of the applicant;
- (g) the type of aircraft proposed to be used;
- (h) the remuneration and general conditions of employment of aircraft and other personnel employed by the applicant;
- (i) and there shall be taken into consideration objections or representations duly made in accordance with the provisions of these Regulations, provided that the Minister shall not be required to consider any objection or representation which in his view is frivolous or vexatious.

## **22. Attachment of conditions**

The Minister may attach such conditions to any licence or permit as he thinks fit having regard to the nature and circumstances of the applications in respect of which the permit is granted and may vary, suspend or add to any such conditions so attached from time to time by notice in writing to the holder of such licence or permit.

## **23. Holder of licence to make return**

Without prejudice to the generality of regulation 22 of these Regulations, the conditions which may be attached to any licence or permit shall include-

- (a) conditions relating to the furnishing, by the holder of the licence or permit, to the Minister of Information in respect of any air services provided under the licence or permit and relating to the time within which such particulars shall be furnished; and

(b) conditions as to the fares, freight or other charges to be charged by the holder of the licence or permit in respect of any air service provided thereunder.

#### **24. No right to continuance of benefits of licence or permit**

Nothing in these Regulations shall confer upon the holder of a licence or permit or upon any other person any right to the continuance of any benefits arising from the provisions of these Regulations or from any licence or permit granted thereunder or from any conditions attached to any such licence or permit.

#### **25. Fees payable for a licence or permit**

(1) Upon the grant of any licence or permit the person to whom the same is granted shall pay to the Minister, on the day on which the licence or permit is expressed to take effect, a fee of twenty naira in respect of each year or part of a year of the period for which the licence or permit is expressed to remain in force.

(2) Upon the grant of any provisional licence or provisional permit the person to whom the same is granted shall pay to the Minister on the day on which such licence or permit is expressed to take effect a fee of four naira.

(3) No refund of any fee paid in respect of the grant of a licence or permit or a provisional licence or permit shall be made on the surrender of the licence or permit or otherwise, save where a licence or permit is surrendered before its normal date of expiry upon the grant of a new licence or permit, in substitution for the surrendered licence or permit, authorising a service over the same route, in which case there shall be refunded the sum of twenty naira for each full year of the unexpired period of the licence or permit but the holder shall in addition to the normal fee for the new licence or permit pay an additional fee of four naira.

#### **26. Reference to include provisional licence**

Any reference in regulations 17, 22, 23 or 24 of these Regulations to a licence or a permit shall unless the context otherwise requires be construed as including a reference to a provisional licence or a provisional permit, as the case may be.

#### **27. Offences by officers of the body corporate**

Where an offence against these Regulations has been committed by a body corporate, every person who, at the time of the commission of the offence was a director, general manager, secretary or other similar officer of the body corporate, or was purporting to act in any such capacity, shall be deemed to be guilty of that offence, unless he proves that the offence was committed without his consent or connivance and that he exercised all such diligence to prevent the commission of the offence as he ought to have exercised having regard to the nature of his functions in that capacity and to all the circumstances.

---

## SCHEDULES

### FIRST SCHEDULE

**1.** Applications for licences shall be made in writing to the Minister and shall be addressed to-

The Minister, Ministry of Aviation, Abuja.

**2.** Every application for a licence shall be signed by the person applying for the licence and if made by any corporate body shall be signed by a person duly authorised in that behalf by such body.

**3.** Every application for a licence shall be sent to the Minister, Ministry of Aviation, so as to reach him on a date not less than eight weeks before the date on which it is desired that the licence shall take effect:

Provided that an application for a licence may, in the discretion of the Minister, be accepted and dealt with notwithstanding that this paragraph has not been complied with.

**4.** Application for licences shall contain the following initial particulars-

(a) the name and address of the applicant;

(b) the places between which passengers or goods are to be carried;

(c) the places at which intermediate landings are to be made for the purpose of loading or landing passengers or goods;

(d) the times and frequency of the service;

(e) the number and types of aircraft proposed to be used on the service;

(f) whether the service is to carry passengers, goods or both;

(g) the maximum fares to be charged to passengers in respect of any journey or portion of a journey for which separate fares are charged;

(h) the date on which the service is to commence;

(i) the period for which the licence is desired;

(j) the particulars of any insurance policy held or proposed by the applicant to cover third party risks in respect of the proposed service;

(k) the particulars of other services operated by the applicant at the time of the application or immediately prior to that time;

(l) the particulars of working arrangements with other companies;

(m) the particulars of the applicant's business and an audited copy of the last published accounts.

5. On receipt of the application, the Minister shall be entitled to request the applicant to supply such further information as he may reasonably require; and the applicant shall supply the Minister with any further information so requested by him.

---

## SECOND SCHEDULE

### *Publication of decisions*

#### 1. Particulars of the decisions of the Minister-

(a) on applications for licences; or

(b) to revoke or suspend a licence,

shall be published by notice in the *Gazette* and such notices shall contain the particulars set out in paragraph 2 of this Schedule.

#### 2. The particulars shall be-

(a) in the case of an application-

(i) the name and address of the applicant;

(ii) a reference to the *Gazette* in which notice of the application was published;

(iii) such particulars as will enable the application to be identified;

(iv) an indication whether the licence was granted as applied for, granted with modifications (the modifications to be stated) or refused;

(b) in the case of a revocation or suspension-

(i) the name and address of the applicant;

(ii) such information as will enable the licence to be identified, including places between which passengers or goods are to be carried;

(iii) the places at which intermediate landings are to be made for the purpose of loading or landing passengers or goods;

(iv) the date from which revocation or suspension takes effect and, in the case of suspension, the period of suspension;

(v) the grounds on which the licence is revoked or suspended.

---

THIRD SCHEDULE

*Applications for permits*

**1.** Applications for permits under Part III shall be made in writing or by telegram to the Minister and shall be addressed to-

The Minister, Ministry of Aviation, Abuja.

**2.** Applications for permits shall contain the following initial particulars-

(a) the name of the operator;

(b) the type of aircraft and registration marks;

(c) the date and time of arrival at, and departure from, the airport or airports concerned;

(d) the place or places of embarkation or disembarkation, in the case of passengers and freight;

(e) the purpose of flight and number of passengers and nature and amount of freight, where applicable;

(f) the name, address and business of the charterer, if any.

**3.** On receipt of the application, the Minister shall be entitled to request the applicant to supply such further information as he may reasonably require, and the applicant shall supply the Minister with any further information so requested by him.

---

# CIVIL AVIATION (FEES) REGULATIONS

## ARRANGEMENT OF REGULATIONS

### REGULATION

1. Short title.
2. Interpretation.
3. Aircraft landing fee.
4. Helicopter landing fee.
5. Passengers' fees for services.
6. Powers of Minister.
7. Exemption from landing fee.
8. Fees for night landing.
9. Minister's power of exemption.
10. Fees for services rendered on landing.
11. No reduction of fees.
12. Housing and parking fees.
13. Licensing fees.
14. Power to amend fees.

### SCHEDULES

#### FIRST SCHEDULE

*Landing fees*

#### SECOND SCHEDULE

*Airports*

#### THIRD SCHEDULE

*Accommodation fees*

#### FOURTH SCHEDULE

*Fees for certificates, licences, etc.*

---

## CIVIL AVIATION (FEES) REGULATIONS

under Regulation 78 of the Civil Aviation (Air Navigation) Regulations

[Commencement.]

[1st December, 1965]

### 1. Short title

These Regulations may be cited as the Civil Aviation (Fees) Regulations.

## 2. Interpretation

(1) In these Regulations-

" **the Air Navigation Regulations**" means the Civil Aviation (Air Navigation) Regulations, and expressions used in these Regulations shall, unless the context otherwise requires, have the same respective meanings as in the Air Navigation Regulations;

[L.N. 15 of 1966.]

"**aircraft**" includes military aircraft;

"**all up weight**" means the maximum total weight in force in respect of the aircraft, or if no such certificate is in force in the certificate of airworthiness last in force in respect of that aircraft, or in any other case, the maximum total weight authorised of the proto-type or modification thereof to which the aircraft in the opinion of the Minister conforms;

"**day**" means the time between sunrise and sunset, sunrise and sunset being determined at surface level;

"**landing**" means a landing at a Government airport in Nigeria;

"**night landing**" means any landing made between sunset and sunrise or any landing made at any other time when operational considerations require the provision of airport lighting;

"**private aircraft**" means an aircraft with a certificate of airworthiness which has been issued subject to the condition that the aircraft shall be flown only for purposes other than public transport or aerial work;

"**standard landing fee**" means the landing fee calculated by reference to the all up weight of the aircraft in accordance with the First Schedule to these Regulations.

(2) The Interpretation Act shall apply for the purpose of the interpretation of these Regulations.

[Cap. 123.]

## 3. Aircraft landing fee

Subject to the provisions of these Regulations, the fee payable in respect of any landing by an aircraft shall be the standard landing fee.

## 4. Helicopter landing fee

The fee payable in respect of a landing by a helicopter shall be one half of the standard landing fee applicable to it.

## 5. Passengers' fees for services



Any passenger leaving a Government airport on an international flight shall pay a charge of five naira in respect of services provided at such airport.

## **6. Powers of Minister**

(1) The Minister may-

(a) on application made by a *bona fide* flying club in respect of an aircraft belonging to it of an all up weight not exceeding 4,500 lbs. and on payment of a fee of ₦6;

(b) on application made by the owner of a private aircraft of an all up weight not exceeding 3,000 lbs. and on payment of a fee of ₦13;

(c) on application made by the owner of a private aircraft of an all up weight exceeding 3,000 lbs., but not exceeding 11,000 lbs. and on payment of a fee of ₦25,

issue to the flying club or owner, as the case may be, in respect of such aircraft as aforesaid a landing card relating to such Government airports as may be specified in the card.

(2) A landing card so issued shall remain in force for a period of one year from the date of its Issue.

(3) An aircraft in respect of which a landing card has been so issued and is in force may land by day at the Government airports specified in the card without payment of any further landing charge if but only if, the aircraft is being used at the time of landings-

(a) in the case of an aircraft in respect of which a landing card has been issued under paragraph (1) (a) of this regulation, by a member of the flying club on whose application the card was issued and for a purpose other than public transport or aerial work; or

(b) in the case of an aircraft in respect of which a landing card has been issued under paragraph (1) (b) or (1) (c) of this regulation, by the person on whose application the card was issued and for a purpose other than public transport or aerial work.

## **7. Exemption from landing fee**

(1) Subject to the provisions of this regulation, no landing fee shall be payable in respect of a landing by an aircraft at an airport (in this paragraph referred to as "the Government airport") at the end of a flight in respect of which all the following conditions were satisfied-

(a) the flight began and finished at the Government airport with no intermediate landing at any other place;

(b) the flight was undertaken solely for the purpose of testing the aircraft or its engines, instruments, radio or other equipment;

(c) notice was given to the person in charge of the Government airport before the beginning of the flight that the flight was to be a test flight for the purpose of this regulation.

(2) The provisions of paragraph (1) of this regulation shall not apply in respect of a landing by an aircraft if the next preceding landing by that aircraft was a landing to which the said paragraph (1) applied.

(3) No fee shall be payable in respect of a landing by an aircraft at an airport (in this regulation referred to as "the Government airport") if-

(a) such landing takes place within a period of one hour after the aircraft has completed a landing at the Government airport in respect of which the landing fee provided for in regulation 3 or 4 of these Regulations has become payable; and

(b) the aircraft has not during the aforesaid period of one hour landed at any place other than the Government airport.

### **8. Fees for night landing**

There shall be payable in respect of a night landing, in addition to any other fee payable under these Regulations in respect of the landing, the following fee-

(a) in the case of a night landing by a public transport aircraft at any airport specified in the Second Schedule to these Regulations, a fee of ₦50 or one half of the standard landing fee applicable to the aircraft, whichever may be the less;

(b) in any other case, a fee equal to one half of the standard landing fee applicable to the aircraft.

### **9. Minister's power of exemption**

The Minister may in his discretion and subject to such conditions or limitations as he thinks fit, exempt from payment of any or all landing fees any of the following classes of aircraft or any aircraft of any such class-

(a) military aircraft of the Federation of Nigeria;

(b) military aircraft of any other State;

(c) aircraft belonging to or employed in the service of the Government of the Federation of Nigeria, not being military aircraft;

(d) aircraft belonging to or employed in the service of any of the State Governments of Nigeria;

(e) aircraft belonging to or employed in the service of any other state or of any person or body entitled to diplomatic privileges.

### **10. Fees for services rendered on landing**

The landing fees provided for in these Regulations shall in the case of an airport for the time being designated as a customs airport, pursuant regulations 66 of the Air Navigation Regulations, include the

use of facilities for the inward and outward clearance by customs, aircraft, passengers and passengers' baggage, and for immigration and health facilities.

#### **11. No reduction of fees**

Notwithstanding anything to the contrary contained in these Regulations, no reduction of landing fees shall be made by reason of the unavailability of any airport, air route facility, airway facility, or other facility whatsoever.

#### **12. Housing and parking fees**

(1) There shall be payable in respect of the accommodation of an aircraft at a Government airport, a fee determined in accordance with the Third Schedule to these Regulations by reference to the space occupied by the aircraft, such fee being, for each hour or part of an hour that the aircraft is accommodated in a hangar, the fee specified in the said Schedule as the housing fee, and, for each hour or part of an hour that the aircraft is accommodated otherwise than in a hangar, the fees specified therein as the parking fee:

Provided that, if the period between the arrival of an aircraft at a Government airport and its departure therefrom does not exceed six hours, no fee shall be payable in respect of any part of the said period during which the aircraft is accommodated otherwise than in a hangar.

(2) For the purposes of this regulation and the Third Schedule to these Regulations, an aircraft shall be deemed to occupy such space as is the product of its maximum span and its maximum length.

[Third Schedule.]

(3) The person in charge of a Government airport, or any person authorised by him for the purpose may, for reasons of safety or for any other reason which, in his absolute discretion, he may consider good and sufficient for the proper conduct and use of the airport, at any time order any aircraft on the airport to be housed in a hangar, and thereupon the fee payable in respect of the accommodation of the aircraft in a hangar shall become payable.

#### **13. Licensing fees**

The provisions of the Fourth Schedule to these Regulations shall have effect with respect to the fees to be paid in connection with the certificates, licences, and other documents, and with examinations, tests, inspections, investigations, permissions and approvals, required by or for the purposes of the Air Navigation Regulations or any regulations made thereunder.

[Fourth Schedule.]

#### **14. Power to amend fees**

The Minister may at any time by notice in the Federal *Gazette*, amend any of the fees specified in the First, Third and Fourth Schedules hereto.

[First, Third and Fourth Schedules.]

---

SCHEDULES

FIRST SCHEDULE

*Table of Landing Fees*

*All up weight Aircraft*

*Charges*

Not exceeding 11,000 lbs. (5,000 kgs)	55 kobo for each 1,100 lbs.
Exceeding 11,000 lbs. (5,000 kgs) but not exceeding 33,000 lbs. (15,000 kgs)	₦1.10 kobo for each 2,200 lbs. (1,000 kgs) or part thereof
Exceeding 33,000 lbs. (15,000 kgs) but not exceeding 88,000 lbs. (40,000 kgs)	₦1.20 kobo for each 2,200 lbs (1,000 kgs) or part thereof
Exceeding 88,000 lbs. (40,000 kgs)	₦1.40 kobo for each 2,200 lbs (1,000 kgs) or part thereof

---

SECOND SCHEDULE

Lagos  
Kano  
Port Harcourt

---

THIRD SCHEDULE

Accommodation Fees

Space Occupied	<i>Housing</i>	<i>Parking</i>
	Fee	Fee
	₦ k	₦ k
Not exceeding 300 sq. ft .....	34	18
Exceeding 300 but not exceeding 500 sq. ft .....	54	28

Exceeding 500 but not exceeding 700 sq. ft.....	74	38
Exceeding 700 but not exceeding 1,000 sq. ft.....	1.08	54
Exceeding 1,000 but not exceeding 1,500 sq. ft.....	1.60	80
Exceeding 1,500 but not exceeding 2,000 sq. ft.....	1.14	1.08
Exceeding 2,000 but not exceeding 3,000 sq. ft.....	2.34	1.68
Exceeding 3,000 but not exceeding 4,000 sq. ft.....	4.00	2.00
And where the space occupied exceeds 4,000 sq. ft. in respect of each additional 1,000 sq. ft. or part thereof .....	68	34

---

FOURTH SCHEDULE

*Fees for certificates, licences, etc.*

**1. Charges for air navigation facilities, etc.**

(1) As from the commencement of this paragraph, air navigation facilities and services shall be regulated by the following formula, that is  $R = T \times D \times P$  where-

[S.I. 1 of 1990.]

(a) R = Charge payable;

(b) T = Unit rate;

(c) D = Distance flown within Nigeria's airspace measured in hundreds of kilometres reduced by 20 km for each take off from and each landing at airports on Nigerian territory; and

(d) P = Weight factor.

(2) The unit rate for any facility or service shall be-

(a) in the case of international flights, US \$55; and

(b) in the case of domestic flights, ₦ 100.

**2. Certificate of registration**

(1) The fee to be paid for the issue of a certificate of registration for an aircraft of an all up weight of-

- (a) under 3,000 kilograms, shall be ₦200;
- (b) 3,000 kilograms but not exceeding 6,000 kilograms, shall be ₦500;
- (c) 6,000 kilograms but not exceeding 15,000 kilograms, shall be ₦1,000;
- (d) 15,000 kilograms but not exceeding 50,000 kilograms, shall be ₦2,000;
- (e) 50,000 kilograms and above, ₦4,000.

(2) An additional fee of ₦2,000 shall be payable if an applicant requests for a special registration mark which is out of sequence.

### **3. Reservation of registration mark**

(1) A person who applies for the reservation of a registration mark shall pay-

- (a) in the case of an aircraft of less than 3,000 kilograms in weight, a fee of ₦100; and
- (b) in the case of an aircraft of any other weight, a fee of ₦200.

(2) A reservation under sub-paragraph (1) of this paragraph shall be for a period of 6 months or part thereof and may be renewed for further periods of 6 months or parts thereof.

### **4. Aircraft spare parts stockist's certificate**

(1) A person who applies for a dealer's or aircraft spare parts stockist's certificate shall pay a fee of ₦250.

(2) A certificate under sub-paragraph (1) of this paragraph shall be for a period of one year and may be renewed from year to year.

### **5. Registration of aircraft mortgage**

(1) A person who applies for the registration of the mortgage of an aircraft shall pay-

- (a) on the first ₦100,000 secured by the mortgage, a fee of ₦20 for each complete ₦10,000;
- (b) on the next ₦900,000 secured by the mortgage, a fee of ₦20 for each ₦100,000 or part thereof; and
- (c) thereafter, a fee of ₦20 for each ₦1,000,000 or part thereof,

so however that the minimum fee payable under this sub-paragraph shall be ₦60 and the maximum shall be ₦1,000.

(2) Where the application under sub-paragraph (1) of this paragraph-

- (a) does not specify the amount of the mortgage, the fee shall be ₦1,000;

(b) is made for a mortgage for more than one aircraft, the applicant shall pay the fee as set out in subparagraph (1) or (2) of this paragraph, as the case may be, for the first aircraft and a fee of N60 for each additional aircraft.

## **6. Permit for an aircraft to fly without certificate of airworthiness**

A person who applies for a permit to fly an aircraft within Nigeria in pursuance of paragraph (e) of regulation 4 (1) of the Air Navigation Regulations 1965, shall pay-

(a) in respect of any investigation required in connection with the application, a fee of an amount equivalent to the cost of making the investigation; and

(b) for the issue of the permit-

(i) a fee of ~~N~~250 for an aircraft with an all up weight not exceeding 2,730 kilograms; and

(ii) a fee of ~~N~~500 for an aircraft with an all up weight exceeding 2,730 kilograms.

## **7. Certificate of airworthiness**

(1) A person who applies for an initial issue of a certificate of airworthiness in pursuance of regulation(1) of the Air Navigation Regulations 1965, shall pay-

[L.N. 15 of 1966.]

(a) in respect of any investigation required in connection with the application, a fee of an amount equivalent to the cost of making the investigation but not exceeding ~~N~~40,000 taking into account paragraph 33 of this Schedule, where applicable;

(b) for the issue of the certificate-

(i) in the case of a glider with a maximum weight not exceeding 1,000 kilograms, a fee of ~~N~~200;

(ii) in the case of a glider with a maximum weight not exceeding 1,000 kilograms, a fee of ~~N~~250;

(iii) in the case of a balloon, a fee of ~~N~~350;

(iv) in the case of an aircraft, other than a glider, balloon or helicopter with a maximum weight not exceeding 2,730 kilograms, for the first 1,000 kilograms ~~N~~350 and for every additional 500 kilograms or part thereof, a fee of ~~N~~50;

(v) in the case of a helicopter with a maximum all up weight not exceeding 2,730 kilograms, for the first 1,000 kilograms, a fee of ~~N~~400 and for every additional 500 kilograms or part thereof, a fee of ~~N~~60;

(vi) in the case of a helicopter with a maximum all up weight exceeding 2,730 kilograms, for the first 1,000 kilograms, a fee of ~~N~~500, and for every additional 500 kilograms or part thereof, a fee of ~~N~~70;

(vii) in the case of an aircraft not within the categories specified in sub-paragraphs (1) (b) (i) to (1) (b) (vi) of this paragraph, for the first 1,000 kilograms, a fee of ₦800 and for every additional 500 kilograms or part thereof, a fee of ₦80.

(2) A person who applies for an initial issue of a certificate of airworthiness for a proto-type aircraft, including a balloon, helicopter or fixed-wing aircraft, shall pay-

- (a) the cost of any investigation required in connection with the application taking into account the additional charge specified in paragraph 33 of this Schedule, where applicable; and
- (b) the fees specified in sub-paragraph (1) (b) of this paragraph, so however that in the case of a series of aircraft only the fees specified in sub-paragraph (1) (b) of this paragraph shall be payable.

### **8. Renewal of a certificate of airworthiness**

The fees to be paid for the renewal of a certificate of airworthiness shall be-

- (a) in the case of a glider with a maximum all up weight of 1,000 kilograms or less, ₦350;
- (b) in the case of a glider with a maximum all up weight exceeding 1,000 kilograms, ₦500;
- (c) in the case of a balloon, ₦600;
- (d) in the case of an aircraft other than a glider, balloon or helicopter with a maximum all up weight of 2,730 kilograms or less-
  - (i) for the first 1,000 kilograms, ₦500;
  - (ii) for every additional 500 kilograms or part thereof, ₦60;
- (e) in the case of a helicopter with a maximum all up weight of 2,730 kilograms or less-
  - (i) for the first 1,000 kilograms, ₦600;
  - (ii) for every additional 500 kilograms or part thereof, ₦70;
- (f) in the case of a helicopter with a maximum all up weight exceeding 2,730 kilograms-
  - (i) for the first 1,000 kilograms, ₦700;
  - (ii) for every additional 500 kilograms or part thereof, ₦80;
- (g) in the case of any other aircraft not within the categories specified in sub-paragraphs (a) to (f) of this paragraph-
  - (i) for the first 1,000 kilograms, ₦1,000;
  - (ii) for every additional 500 kilograms or part thereof, ₦100.



### **9. Re-issue of a certificate of airworthiness**

The fees to be paid for the re-issue of a certificate of airworthiness following its revocation shall be-

- (a) if the certificate revoked was an initial issue, the same as for an initial issue of such certificate;
- (b) if the certificate revoked was one that had been renewed, the same as for the renewal of such certificate.

### **10. Certificate of airworthiness for export**

The person who applies for a certificate of airworthiness for the export of an aircraft shall pay-

- (a) in respect of any investigations required in connection with the application, a fee of an amount equivalent to the cost of making the investigations; and
- (b) for the issue of the certificate, the fee as set out in paragraph 7 (b) of this Schedule.

### **11. Change of category of certificate of airworthiness**

The fee to be paid for an application to change the category of a certificate of airworthiness, to permit an aircraft to fly for an additional purpose, shall be ₦250.

### **12. Approval for aircraft equipment**

A person who applies for the approval of an aircraft equipment (other than the engine, modification or repairs of such equipment), its installation, modification and repair, shall pay-

- (a) in respect of any investigation required in connection with the application, a fee of an amount equivalent to the cost of the investigation but not exceeding ₦20,000; and
- (b) where the investigation includes travelling abroad, the additional charge specified in paragraph 33 of this Schedule.

### **13. Approval for modification or repair of aircraft, etc.**

(1) A person who applies for approval to carry out modification, repair or any other works on an aircraft, other than on its engine shall pay-

- (a) in respect of any investigation required in connection with the application, a fee of an amount equivalent to the cost of the investigation not exceeding ₦25,000; and
- (b) where the investigation involves travelling abroad, the additional charge specified in paragraph 33 of this Schedule.

(2) The fee to be paid for the approval of the organisation appointed to carry out the modification, repairs or other works on the aircraft or for any variation of the terms of the approval, shall be ₦2,000;

and where the Minister or any person or agency authorised by him in that behalf inspects more than one site in respect of the approval, a fee of ₦500 shall be paid for each additional site inspected.

(3) Where the organisation referred to in sub-paragraph (2) of this paragraph is situated outside Nigeria-

(a) the fee to be paid shall be £500 or the equivalent thereof in any other convertible currency and where the Minister or any person or agency authorised in that behalf inspects more than one site in respect of the approval, the fee to be paid shall be £200 or the equivalent thereof in any other convertible currency for each additional site so inspected; and

(b) the additional charge specified in paragraph 33 of this Schedule shall also be paid.

(4) The fee to be paid for the renewal of any approval granted under this paragraph shall be the same as for the grant of the initial approval.

#### **14. Aircraft type certificate**

The fee to be paid upon filing an application for an aircraft type certificate shall be such an amount as may be specified, from time to time, by the Minister but not exceeding ₦20,000 for every 500 kilograms or part thereof for the period of investigation and where the investigation involves travelling abroad, the additional charge specified in paragraph 33 of this Schedule shall be paid.

#### **15. Approval of engine and auxiliary power**

A person who applies for the approval of an engine or auxiliary power unit shall pay-

(a) in respect of any investigation required in connection with the application, a fee of an amount equivalent to the cost of the investigation, including investigation concerning defects in or modifications to an approved engine or auxiliary power unit but not exceeding-

(i) in the case of a gas turbine engine, ₦500,000;

(ii) in the case of an engine of 300 kilograms or less, ₦150,000;

(iii) in the case of any other engine or auxiliary power unit of above 300 kilograms, ₦300,000;

(b) where any investigation connected with the application involves travelling abroad, the additional charge specified in paragraph 33 of this Schedule.

#### **16. Licence for aircraft maintenance engineer**

Any person who applies for the grant, renewal, variation or validation of a licence to act as an aircraft maintenance engineer or for the inclusion of a type rating in such licence shall pay-

(a) in respect of the application, including assessment of loggings or documents submitted therewith, a fee of ₦50;

(b) where an examination is required, a fee of ₦100;

- (c) where no examination is required, a fee of ₦50;
- (d) where an extension of rating is to be included in the licence, a fee of ₦50;
- (e) for the renewal of a licence-
  - (i) where the applicant is not required to pass an examination, a fee of ₦50;
  - (ii) where the applicant is required to pass an examination, a fee of ₦100;
- (f) for the replacement of a licence, a fee of ₦100;
- (g) for a copy of any certificate issued by the Minister or any other person or agency authorised in that behalf, a fee of ₦50;
- (h) for the renewal of a Certificate of Validity Authorisation ₦50;

**17. Air transport licence or permit**

(1) A person who applies for the grant of an initial air transport licence or permit shall pay-

- (a) on making the application, a fee of ₦500;
- (b) on being granted the licence or permit, a fee of ₦5,000;
- (c) for the renewal of an air transport licence, the variable charges set out in the following table, that is-

<i>Description of licence</i>	<i>per 1000 passenger kilometres flown pursuant to the licence</i>	<i>per 1000 tonne kilometres flown pursuant to the licence</i>
(1)	(2)	(3)

Air Transport Licence	50k	₦2
-----------------------	-----	----

(2) The holder of a licence shall, in respect of each period of one month during which a licence is in force, pay the variable charges specified in sub-paragraph (1) (c) of this paragraph but no variable charge shall be paid in respect of any passenger or cargo on an aircraft where the maximum weight does not exceed 5,700 kilograms.

(3) In this paragraph-

**"passenger kilometres"** means the number of passengers multiplied by the distance flown in kilometres;

**"tonne kilometres"** means the number of tonnes multiplied by the distance flown in kilometres.

**18. Aerodrome flight information service officers licence, etc.**

Any person who applies for grant of a flight information service officer, air host or air hostess licence shall pay-

- (a) for the assessment of the application, a fee of N50;
- (b) on being granted the licence, a fee of ₦50;
- (c) where any written examination is required, a fee of ₦100;
- (d) for any additional aerodrome included in the licence, a fee of ₦50;
- (e) for the renewal of the licence, a fee of ₦50.

**19. Flight crew licence**

(1) A person who applies for the grant, extension or renewal of a licence to act as a flight crew member shall pay-

- (a) in the case of the grant or renewal of-
    - (i) an airline pilot's licence;
    - (ii) a senior commercial pilot's licence;
    - (iii) a commercial pilot's licence;
    - (iv) a flight navigator's licence; or
    - (v) a flight engineer's licence,a fee of ₦100;
  - (b) in the case of the grant or renewal of instrument rating, a fee of ₦100;
  - (c) in the case of the grant or renewal of a student or private pilot licence, a fee of ₦50;
  - (d) for the inclusion of any rating in the licence, a fee of ₦50.
- (2) Where a person who makes an application under subparagraph (1) of this paragraph requires any examination in connection with the application, he shall pay-
- (a) in the case of ground subjects required for a commercial pilot licence, a fee of ₦100 per subject;
  - (b) in the case of a Performance "A" examination, a fee of ₦150;
  - (c) in the case of any other Performance Group, a fee of ₦100;

(d) in the case of any loading examination, a fee of ₦100;

(e) in the case of any type technical examination for any sitting for-

(i) any aircraft of an all up weight of less than 2,730 kilograms, a fee of ₦100;

(ii) any aircraft of an all up weight of more than 2,730 kilograms but less than 5,700 kilograms, a fee of ₦150;

(iii) any aircraft of an all up weight of 5,700 kilograms and above, a fee of ₦200;

(f) in the case of any air law for pilots examination, a fee of ₦100;

(g) in the case of ground subjects examinations for-

(i) any flight navigator's licence, a fee of ₦100 per subject;

(ii) any private pilot licence (aircraft), a fee of ₦100 per subject;

(iii) any balloon or any airship, a fee of ₦75 per subject.

## **20. Application for authorisation or approval to act as an authorised examiner**

A person who applies for authority or approval to act as an authorised examiner shall pay-

(a) in the case of any aircraft of an all up weight of below 5,700 kilograms, a fee of ₦100;

(b) in the case of an aircraft of an all up weight of 5,700 kilograms or above, a fee of ₦250.

## **21. Approval of flight simulator**

A person who applies for approval or renewal of approval of a flight simulator shall pay-

(a) where the authorised weight for the aeroplane type simulated by the flight simulator does not exceed 1,500 kilograms, a fee of ₦3,000;

(b) in any other case where the authorised weight exceeds 1,500 kilograms-

(i) for the initial approval, a fee of ₦10,000;

(ii) for renewal of the approval, a fee of ₦5,000;

(iii) where any travelling abroad is undertaken in connection with the application, the additional charge specified in paragraph 33 of this Schedule.

## **22. Approval of flying schools**

A person who applies for approval or renewal of approval of a flying training school shall pay-

(a) in the case of a commercial pilot's licence course (aeroplane) and instrument rating-

- (i) initial approval, a fee of ₦4,000;
  - (ii) renewal of approval, a fee of ₦3,000;
- (b) in the case of a commercial pilot's licence course (helicopter)-
- (i) for the initial approval, a fee of ₦3,000;
  - (ii) for renewal of the approval, a fee of ₦2,500;
- (c) in the case of a commercial pilot's licence course (aeroplane) no instrument rating-
- (i) for the initial approval, a fee of ₦2,500;
  - (ii) for renewal of the approval, a fee of ₦2,000;
- (d) in the case of a private pilot licence course-
- (i) for the initial approval, a fee of ₦1,000;
  - (ii) for renewal of the approval, a fee of ₦500.

### **23. Type rating or type conversion for a new or unusual aircraft**

A person who applies for an aircraft type rating or type conversion for any new or unusual type of aircraft shall pay the cost of any training required of any employee of the Ministry or a Department of the Ministry engaged in conducting any flying test technical examination connected with the type rating or type conversion.

### **24. Flight crew member certificate**

The fee to be paid for an application for the grant of one year flight crew certificate shall be N100.

### **25. Aerodrome licence**

A person who applies for an aerodrome licence shall pay-

- (a) for the inspection of the aerodrome where the maximum weight of the aircraft that can use the aerodrome-
- (i) does not exceed 3,200 kilograms, a fee of ₦500;
  - (ii) exceeds 3,200 kilograms but less than 7,500 kilograms, a fee of ₦1,000;
  - (iii) exceeds 7,500 kilograms, or a fee of ₦1,500;
- (b) for the grant or renewal of the licence after inspection, a fee of ₦3,000.

### **26. Air operator's certificate**

(1) A person who applies for an air operator's certificate shall pay a fee of an amount, appropriate to the maximum total authorised weight of the heaviest type of aircraft specified in the application, as set out in sub-paragraph (2) of this paragraph.

(2) The fee to be paid under sub-paragraph (1) of this paragraph shall be where the maximum total authorised weight of the aircraft-

- (a) does not exceed 2 tonnes, ₦1,500;
- (b) exceeds 2 tonnes but less than 15 tonnes, ₦2,500;
- (c) exceeds 15 tonnes ₦6,000.

### **27. Variation of air operator's certificate**

(1) A person who applies for the variation of an air operator's certificate to specify an additional type of aircraft in the certificate shall pay a fee of an amount, appropriate to the maximum total authorised weight of each type of aircraft specified in the application, as set out in sub-paragraph (2) of this paragraph.

(2) The fee to be paid under sub-paragraph (1) of this paragraph shall be, where the total authorised weight of the aircraft-

- (a) does not exceed 2 tonnes, ₦ 1,000;
- (b) exceeds 2 tonnes but less than 15 tonnes, ₦1,500;
- (c) exceeds 15 tonnes ₦4,000.

### **28. Annual charges on air operator's certificate**

(1) The holder of an air operator's certificate shall, on the 1st of January in each year during the whole or part of which the certificate is in force, pay a fee of an amount, appropriate to the maximum total authorised weight of the heaviest type of aircraft specified in the certificate, as set out in sub-paragraph (2) of this paragraph.

(2) The fee to be paid under sub-paragraph (1) of this paragraph shall be, where the maximum total authorised weight of the aircraft-

- (a) does not exceed 2 tonnes, ₦500;
- (b) exceeds 2 tonnes but less than 15 tonnes, ₦500 for the first 2 tonnes and ₦50 for each additional 500 kilograms or part thereof;
- (c) exceeds 15 tonnes or ₦2,500.

### **29. Charge on air operator's certificate**

(1) The holder of an air operator's certificate shall, for every month in which the certificate is in force for an aircraft of a maximum authorised weight of less than 15 tonnes, pay a fee, according to the number of hours (rounded up to the nearest whole hour) flown by each aircraft operated by him pursuant to the certificate, as set out in sub-paragraph (2) of this paragraph.

(2) The fee to be paid under sub-paragraph (2) of this paragraph shall be-

(a) in the case of an aircraft with passenger seat of 10, 40k per hour;

(b) in the case of an aircraft with passenger seat of more than 10 but not more than 20, 70k per hour;

(c) in the case of an aircraft with passenger seat of more than 20, ~~₦~~1.50k per hour.

(3) The holder of an air operator's certificate for one or more types of aircraft with a maximum total authorised weight of over 15 tonnes shall, for every month or part thereof in which the certificate is in force, pay a fee, according to the seat kilometres and tonne kilometres flown by each aircraft operated by him pursuant to the certificate, as set out in sub-paragraph (4) of this paragraph.

(4) The fee to be paid under sub-paragraph (3) of this paragraph shall be-

(a) ~~₦~~10 per 1,000 seat kilometres;

(b) ~~₦~~40 per 1000 tonne kilometres.

(5) The authorised agency of the Ministry, that is, the Federal Civil Aviation Authority, may ask the holder of an air operator's certificate to deposit with the agency an amount out of which shall be deducted any fees due from him under this paragraph.

(6) The amount to be deposited under sub-paragraph (5) of this paragraph shall be calculated according to the hours flown, seat kilometres or tonne kilometres of the corresponding period of the previous year.

### **30. Aerial application certificate**

A person who applies for the grant, renewal or variation of an aerial application certificate shall pay-

(a) in respect of the application, a fee of ~~₦~~1,000;

(b) on the granting or renewal of the certificate, a fee of ~~₦~~250 for each aircraft specified in the certificate;

(c) where the application is for a variation of the certificate to specify an additional aircraft, a fee of ~~₦~~ 250 for each additional aircraft so specified in the certificate;

(d) for the replacement or issue of a copy of any document connected therewith, a fee of N 50.

### **31. Permission for exhibitions**



A person who applies for permission for flying exhibition shall pay the fees in the following table, that is-

<i>Number of Display items</i>	<i>Fees payable</i>
	<b>₦</b>
1-2 display items.....	100
3-6 display items.....	250
7-10 display items.....	500
11 or more display items.....	1,000

**32. Airstrip manning**

The fee to be charged for manning an airstrip shall be 25,000.

**33. Additional charges where functions are performed abroad**

Where any duty connected with any application under this Schedule is performed abroad, the person making the application shall pay-

- (a) additional charges equivalent to the expenses incurred in performing the duty; and
- (b) the cost of the return air ticket of the person performing the duty.

**34. Approval of type, etc., of radio apparatus**

The fees to be paid for an application for the approval of-

- (a) radio apparatus or the manner of the installation thereof; or
- (b) any modification of the apparatus or the manner of its installation, for the purposes of regulation 10 (5) of the Air Navigation Regulations 1965,

shall be an amount equivalent to the cost of making the investigations required in connection with the application but not exceeding ~~₦~~25,000 for any year or part thereof, of the period of the investigation.

**35. Ticket sales tax**

(1) A sales tax of five per cent shall be payable to the agency authorised in that behalf by the Minister, that is, the Federal Civil Aviation Authority on all air tickets, charter, contract and cargo flights, sold in Nigeria.

(2) The sales tax payable under sub-paragraph (1) of the paragraph shall be in the currency in which the ticket was purchased.

**36. Medical examination**

The fee to be paid for an official medical examination for the purposes of the Air Navigation Regulations 1965 or any regulations made thereunder shall, unless otherwise provided, be ~~₹~~200.

---

## CIVIL AVIATION (AIRCRAFT PERFORMANCE) REGULATIONS

[L.N. 10 of 1966.]

### ARRANGEMENT OF REGULATIONS

#### REGULATION

1. Short title.
2. Interpretation.
3. Aircraft with no performance group classification.
4. Conditions as to weight of aircraft with no performance group classification.
5. Aircraft of performance group A.
6. Conditions as to weight of aircraft of performance group A.
7. Aircraft of performance groups C and D.
8. Conditions as to weight of aircraft of performance groups C and D.
9. Aircraft of performance group X.
10. Conditions as to weight of aircraft of performance group X.

---

## CIVIL AVIATION (AIRCRAFT PERFORMANCE) REGULATIONS

under regulation 24 (1) of the Civil Aviation

[Commencement.]

[1st December, 1965]

### 1. Short title

These Regulations may be cited as the Civil Aviation (Aircraft Performance) Regulations.

### 2. Interpretation

(1) In these Regulations, unless the context otherwise requires-

**"Air Navigation Regulations"** means the Civil Aviation (Air Navigation) Regulations;

**"instrument meteorological conditions"** means weather precluding flight in compliance with the Visual Flight Rules;

**"visual meteorological conditions"** means weather permitting flight in accordance with the Visual Flight Rules;

**"specified"** in relation to an aircraft means specified in, or ascertainable by reference to-

(a) the certificate of airworthiness in force under the Air Navigation Regulations in respect of the aircraft; or

(b) the flight manual or performance schedule included in that certificate;

**"emergency distance available"** means the distance from the point on the surface of the aerodrome at which the aeroplane can commence its take-off run to the nearest point in the direction of take-off at which the aeroplane cannot roll over the surface of the aerodrome and be brought to rest in an emergency without risk of accident;

**"landing distance available"** means the distance from the point on the surface of the aerodrome above which the aeroplane can commence its landing, having regard to the obstructions in its approach path, to the nearest point in the direction of landing at which the surface of the aerodrome is incapable of bearing the weight of the aeroplane under normal operating conditions or at which there is an obstacle capable of affecting the safety of the aeroplane;

**"take-off distance available"** means either the distance from the point of the surface of the aerodrome at which the aeroplane can commence its take-off run to the nearest obstacle in the direction of take-off projecting above the surface of the aerodrome and capable of affecting the safety of the aeroplane or one and one-half times the take-off run available, whichever is the less;

**"take-off run available"** means the distance from the point of the surface of the aerodrome at which the aeroplane can commence its take-off run to the nearest point in the direction of take-off at which the surface of the aerodrome is incapable of bearing the weight of the aeroplane under normal operating conditions;

**"vso"** denotes the stalling speed or minimum steady flight speed with wing flaps in the landing position;

**"Contracting State"** means a State which is a party to the Convention on International Civil Aviation concluded at Chicago on 7 December 1944.

(2) Expressions used in these Regulations shall, unless the context otherwise requires, have the same respective meanings as in the Air Navigation Regulations.

(3) The assessment of the ability of an aeroplane to comply with the requirements of these Regulations (relating to weight and performance) shall be based on the specified information to its performance:

Provided that, if, in the case of an aeroplane in respect of which there is in force under the Air Navigation Regulations a certificate of airworthiness which does not include a performance group classification, the assessment may be based on the best information available to the commander of the aircraft, in so far as the relevant information is not specified.

(4) In assessing the ability of an aeroplane to comply with condition 7 of regulation 4 of these Regulations, conditions 4 and 5 of regulation 5 of these Regulations, and conditions 2 (2) and 2 (3) of regulation 9, account may be taken of any reduction of the weight of the aeroplane which may be

achieved after the failure of power unit by such jettisoning of fuel as is feasible and prudent in the circumstances of the flight and in accordance with the flight manual included in the certificate of airworthiness relating to the aircraft.

(5) For the purposes of these Regulations-

(a) the weight of an aeroplane at the commencement of the take-off run shall be taken to be its gross weight including everything and everyone carried in or on it at the commencement of take-off run;

(b) the landing weight of the aeroplane shall be taken to be the weight of the aeroplane at the estimated time of landing allowing for the weight of fuel and oil expected to be used on the flight to the aerodrome at which it is intended to land or alternate aerodrome, as the case may be;

(c) where any distance referred to in paragraph (1) of this regulation has been declared in respect of any aerodrome by the authority responsible for regulating air navigation over the territory of the contracting State in which the aerodrome is situated, and in the case of an aerodrome in Nigeria, notified, that distance shall be deemed to be the relevant distance.

(6) Nothing in these Regulations shall apply to any aircraft flying solely for the purpose of training persons to perform duties in aircraft.

*Weight and performance of public transport aeroplanes having no performance group classification in their certificates of airworthiness*

### **3. Aircraft with no performance group classification**

(1) With reference to regulation 24 of the Air Navigation Regulations, an aeroplane registered in Nigeria in respect of which there is in force under these Regulations a certificate of airworthiness which does not include a performance group classification shall not fly for the purpose of public transport unless the weight of the aeroplane at the commencement of the take-off run is such that such of the following conditions as apply to that aircraft are satisfied; that is-

(a) conditions 1 and 2 apply to all aeroplanes to which this regulation applies;

(b) conditions 3 to 9 apply to all aeroplanes to which these Regulations apply-

(i) of which the specified maximum total weight authorised exceeds 12,500 lbs.; or

(ii) of which the specified maximum total weight authorised does not exceed 12,500 lbs., and which comply with neither condition 1 (a) nor condition 1 (b);

(c) conditions 10 to 17 apply to all aeroplanes to which this regulation applies, of which the specified maximum total weight authorised does not exceed 12,500 lbs., and which comply with condition 1 (a) or condition 1 (b) or with both these conditions.

### **4. Condition as to weight of aircraft with no performance group classification**

The conditions referred to in regulation 3 of these Regulations are as follows-

*All aeroplanes*

**1. Either-**

- (a) the wing loading of the aeroplane does not exceed twenty pounds per square foot; or
- (b) the stalling speed of the aeroplane in the landing configuration does not exceed sixty knots; or
- (c) the aeroplane with anyone of its power units inoperative and the remaining power unit or units operating within the maximum continuous power conditions specified, is capable of a gradient of climb of at least 1 in 200 at an altitude of 5,000 feet in the specified international standard atmosphere.

**2. The weight of the aeroplane at the commencement of the take-off does not exceed which ever is the higher of the following weights namely-**

- (a) the maximum take-off weight, if any, specified for the altitude and the air temperature at the aerodrome at which the take-off is to be made;
- (b) the maximum take-off weight, if any, approved in writing by the Minister (after the carrying out of flight tests undertaken on the authority of the Minister) for the take-off of the aeroplane from that aerodrome in the air temperature at the aerodrome.

*Aeroplanes of a specified maximum total weight authorised exceeding 12,500 lbs. and aeroplanes of a specified maximum total weight authorised not exceeding 12,500 lbs. which comply with neither condition 1 (a) nor condition 1 (b) of this regulation*

**3. (1) The distance required by the aeroplane to attain a height of fifty feet, with all power units operating within the maximum take-off power conditions specified, does not exceed the take-off run available at the aerodrome at which the take-off run is to be made.**

**(2) The distance required by the aeroplane to attain a height of fifty feet with all power units operating within the maximum take-off power conditions specified, when multiplied by a factor of either 1.33 for aeroplanes having two power units or by a factor of 1.18 for aeroplanes having four power units, does not exceed the emergency distance available at the aerodrome at which the take-off is to be made.**

**(3) For the purposes of condition 3 (1) and 3 (2) of this regulation the distance required by the aeroplane to attain a height of fifty feet shall be that appropriate to-**

- (a) the weight of the aeroplane at the commencement of the take-off run;
- (b) the altitude at the aerodrome;
- (c) the air temperature at the aerodrome;

- (d) the slope of the surface of the aerodrome in the direction of take-off over the take-off run available and the emergency distance available, respectively; and
- (e) not more than fifty per cent of the reported wind component opposite to the direction of take-off or not less than 150 per cent of the reported wind component in the direction of take-off.

4. (1) The take-off flight path with one power unit inoperative and the remaining power unit or units operating within the maximum take-off power conditions specified, appropriate to-

- (a) the weight of the aeroplane at the commencement of the take-off run;
- (b) the altitude at the aerodrome;
- (c) the air temperature at the aerodrome;
- (d) not more than fifty per cent of the reported wind component opposite to the direction of take-off or not less than 150 per cent of the reported wind component in the direction of take-off,

and plotted from a point fifty feet above the end of the appropriate factored distance required for take-off under condition 3 (2) of this regulation at the aerodrome at which the take-off is to be made, shows the aeroplane either will be able to comply with such requirements in respect of the take-off flight path to be followed as the Minister may have approved in relation to that aerodrome as being requirements which flight tests undertaken on the authority of the Minister have shown will result in safe operation, or, in any case where the Minister has not approved any such requirements in relation to that aerodrome, will clear any obstacle in its path by a vertical interval of at least 35 feet except that if it is intended that an aeroplane shall change its direction by more than 15° the vertical interval shall be not less than fifty feet during the change of direction.

(2) For the purposes of condition 4 (1) of this regulation an obstacle shall be deemed to be in the path of the aeroplane if the distance from the obstacle to the nearest point on the ground below the intended line of flight does not exceed-

(a) when the take-off flight path is to be conducted in instrument meteorological conditions-

(i) a distance of 200 feet plus half the wing span of the aeroplane plus one eighth of the distance from such point to the end of the take-off distance available, measured along the intended line of flight; or

(ii) 5,000 feet;

whichever is the less;

(b) when the take-off flight path is to be conducted in visual meteorological conditions-

(i) 200 feet plus half the wing span of the aeroplane;

(ii) in assessing the ability of the aeroplane to satisfy this condition, it shall not be assumed to make a change of direction of a radius less than a radius of steady turn corresponding to an angle of bank of 15.

**5.** The aeroplane will, in the meteorological conditions expected for the flight, in the event of any one power unit becoming inoperative at any point on its route or on any planned diversion therefrom and with the other power units or unit operating within the maximum continuous power conditions specified, be capable of continuing the flight so as to reach, at a suitable height for landing, an aerodrome at which it can comply with condition 9 of this regulation and to maintain, on each part of its route to such aerodrome, either-

- (a) such height as has been notified as the minimum flight level for that part of the route; or
- (b) if no minimum flight level has been notified for any part of the route, such height as will enable it to clear all obstacles within ten nautical miles either side of the intended track by a vertical interval of at least-
  - (i) 1,000 feet when the gradient of the flight path is not less than zero; or
  - (ii) 2,000 feet when the gradient of the flight path is less than zero.

**6.** The aeroplane will, in the meteorological conditions expected for the flight, at any point on its route or on any planned diversion therefrom be capable of climbing at a gradient of at least 1 in 50, with all power units operating within the maximum continuous power conditions specified at the following altitudes-

- (a) the minimum altitudes for safe flight on each stage of the route to be flown or any planned diversion therefrom specified in, or calculated from the information contained in the operations manual relating to the aeroplane; and
- (b) the minimum altitudes necessary for compliance with conditions 5 and 7, as appropriate.

**7.** If, on the route to be flown or any planned diversion therefrom, the aeroplane will be engaged in a flight over water during which at any point it may be more than ninety minutes' flying time in still air from the nearest shore, it will in the event of two power units becoming inoperative during such time and with the other power units or unit operating within the maximum continuous power conditions specified be capable of continuing the flight having regard to the meteorological conditions expected for the flight clearing all obstacles within ten nautical miles either side of the intended track by a vertical interval of at least 1,000 feet, to an aerodrome at which a safe landing can be made.

**8.** The landing weight of the aeroplane shall not exceed the maximum landing weight, if any, specified for the altitude and the expected air temperature for the estimated time of landing at the aerodrome at which it is intended to land and at any alternate aerodrome.

**9.** (1) The distance required by the aeroplane to land from a height of fifty feet does not, at the aerodrome at which it is intended to land and at any alternate aerodrome, exceed seventy per cent of the landing distance available on-

- (a) the most suitable runway for a landing in still air conditions; and
- (b) the runway that may be required for landing because of the forecast wind conditions.

(2) For the purposes of paragraph (1) of this condition the distance required to land from a height of fifty feet being taken to be that appropriate to-

- (a) the landing weight;
- (b) the altitude at the aerodrome;
- (c) the temperature in the specified international standard atmosphere appropriate to the altitude at the aerodrome;
- (d) a level surface in the case of runways usable in both directions;
- (e) the average slope of the runway in the case of runways usable in only one direction;
- (f) still air conditions in the case of the most suitable runway for a landing in still air conditions;
- (g) not more than fifty per cent of the forecast wind component opposite to the direction of landing or not less than 150 per cent of the forecast wind component in the direction of landing in the case of the runway that may be required for landing because of the forecast wind conditions.

*Aeroplanes of a specified maximum total weight authorised not exceeding  
12,500 lbs. and which comply with either condition 1 (a) or condition 1 (b)  
of this regulation or with both these conditions*

**10.** If the aeroplane is engaged in a flight at night or when the cloud ceiling or visibility prevailing at the aerodrome of departure and forecast for the estimated time of landing at the aerodrome of destination or at any alternate aerodrome, are less than 500 feet and three miles respectively, it will, with anyone of its power units inoperative and the remaining power unit or units operating within the maximum continuous power conditions specified, be capable of achieving and maintaining an altitude of 1,000 feet above all obstacles within ten nautical miles of the relevant aerodrome.

**11.** (1) The distance required by the aeroplane to attain a height of fifty feet with all power units operating within the maximum take-off power conditions specified, does not exceed the take-off run available at the aerodrome at which the take-off is to be made.

(2) The distance required by the aeroplane to attain the height of fifty feet, with all power units operating within the maximum take-off power conditions specified, when multiplied by a factor of 1.33, does not exceed the emergency distance available at the aerodrome at which the take-off is to be made.



(3) For the purpose of paragraphs (1) and (2) of this condition, the distance required by the aeroplane to attain a height of fifty feet shall be that appropriate to-

- (a) the weight of the aeroplane at the commencement of the take-off run;
- (b) the altitude at the aerodrome;
- (c) the temperature in the specified international standard atmosphere appropriate to the altitude at the aerodrome, or if greater, the air temperature at the aerodrome less 15° centigrade;
- (d) the slope of the surface of the aerodrome in the direction of take-off over the take-off run available and the emergency distance available, respectively; and
- (e) not more than fifty per cent of the reported wind component opposite to the direction of take-off or not less than 150 per cent of the reported wind component in the direction of take-off.

**12.** The take-off flight path, with all power units operating within the maximum take-off power conditions specified, appropriate to-

- (a) the weight of the aeroplane at the commencement of the take-off run;
- (b) the altitude at the aerodrome;
- (c) the temperature in the specified international standard atmosphere appropriate to the altitude at the aerodrome, or, if greater, the air temperature at the aerodrome less 15° centigrade; and
- (d) not more than fifty per cent of the reported wind component opposite to the direction of take-off or not less than 150 per cent of the reported wind component in the direction of take-off,

and plotted from a point fifty feet above the end of the factored distance required for take-off under condition 11 (2) of this regulation, at the aerodrome at which the take-off is to be made, shows that the aeroplane either will be able to comply with such requirements in respect of the take-off flight path to be followed as the Minister may have approved in relation to that aerodrome as being requirements which flight tests undertaken on the authority of the Minister have shown will result in safe operation, or, in any case where the Minister has not approved any such requirements in relation to that aerodrome, will clear any obstacle lying within 200 feet plus half the wing span of the aeroplane on either side of its path by a vertical interval of at least 35 feet. In assessing the ability of the aeroplane to satisfy this condition it shall not be assumed to make a change of direction of a radius less than a radius of steady turn corresponding to an angle of bank of 15°.

**13.** The aeroplane shall, in the meteorological conditions expected for the flight, in the event of any one power unit becoming inoperative at any point on its route or on any planned diversion therefrom and with the other power unit or units, if any, operating within the maximum continuous power conditions specified, be capable of continuing the flight so as to reach a point above a place at which a safe landing can be made at a suitable height for such landing.

**14.** The aeroplane shall, in the meteorological conditions expected for the flight, at any point on its route or any planned diversion therefrom, be capable of climbing at a gradient of at least 1 in 50, with all power units operating within the maximum continuous power conditions specified, at the following altitudes-

(a) the minimum altitude for safe flight on each stage of the route to be flown or on any planned diversion therefrom specified in, or calculated from, the information contained in the operations manual relating to the aeroplane; and

(b) the minimum altitudes necessary for compliance with condition 13 of this regulation.

**15.** If on the route to be flown or any planned diversion therefrom the aeroplane will be engaged in a flight over water during which at any point it may be more than thirty minutes' flying time in still air from the nearest shore, it shall, in the event of one power unit becoming inoperative during such time and with the other power unit or units operating within the maximum continuous power conditions specified, be capable of climbing at a gradient of at least 1 in 200 at an altitude of 5,000 feet in the specified international standard atmosphere.

**16.** The landing weight of the aeroplane shall not exceed the maximum landing weight, if any, specified for the altitude and the expected air temperature for the estimated time of landing at the aerodrome at which it is intended to land and at any alternate aerodrome.

**17.** The distance required by the aeroplane to land from a height of fifty feet does not, at the aerodrome at which it is intended to land and at any alternate aerodrome, exceed seventy per cent, or if a visual approach and landing will be possible in the meteorological conditions forecast for the estimated time of landing, eighty per cent of the landing distance available on-

(i) the most suitable runway for a landing in still air conditions; and

(ii) the runway that may be required for landing because of the forecast wind conditions,

the distance required to land from a height of fifty feet being taken to be that appropriate to-

(a) the landing weight;

(b) the altitude at the aerodrome;

(c) the temperature in the specified international standard atmosphere appropriate to the altitude at the aerodrome;

(d) (i) a level surface in the case of runways usable in both directions;

(ii) the average slope of the runway in the case of runways usable in only one direction; and

(e) (i) still air conditions in the case of the most suitable runway for a landing in still air conditions;

(ii) not more than fifty per cent of the forecast wind component opposite to the direction of landing or not less than 150 per cent of the forecast wind component in the direction of landing in the case of the runway that may be required for landing because of the forecast wind conditions.

## WEIGHT AND PERFORMANCE OF PUBLIC TRANSPORT

### *Aeroplanes classified as aeroplanes of performance group A in their certificates of airworthiness*

#### **5. Aircraft of performance group A**

With reference to regulation 24 of the Air Navigation Regulations, an aeroplane registered in Nigeria in respect of which there is in force under those Regulations a certificate of airworthiness in which the aeroplane is designated as being of performance group A, shall not fly for the purpose of public transport unless the weight of the aeroplane at the commencement of the take-off run is such that the conditions set out in regulation 6 of these Regulations are satisfied.

#### **6. Condition as to weight of aircraft with performance group A**

The conditions referred to in regulation 5 are as follows-

1. That weight does not exceed the maximum take-off weight for altitude and temperature specified for the altitude and the air temperature at the aerodrome at which the take-off is to be made.
2. The take-off run, take-off distance and the emergency distance respectively required for take-off, specified as being appropriate to-
  - (a) the weight of the aeroplane at the commencement of the take-off run;
  - (b) the altitude at the aerodrome;
  - (c) the air temperature at the aerodrome;
  - (d) the slope of the surface of the aerodrome in the direction of take-off over the take-off run available, the take-off distance available and the emergency distance available respectively; and
  - (e) not more than fifty per cent of the reported wind component opposite to the direction of take-off or not less than 150 per cent of the reported wind component in the direction of take-off,

do not exceed the take-off run, the take-off distance and the emergency distance available, respectively at the aerodrome at which the take-off is to be made; and in ascertaining the emergency distance required, the point at which the pilot is assumed to decide to discontinue the take-off shall not be nearer to the start of the take-off run than the point at which, in ascertaining the take-off run required and the take-off distance required, he is assumed to decide to continue the take-off, in the event of power unit failure.

- 3. (1)** The net take-off flight path with one power unit inoperative specified as being appropriate to-
- (a) the weight of the aeroplane at the commencement of the take-off run;
  - (b) the altitude at the aerodrome;
  - (c) the air temperature at the aerodrome; and
  - (d) not more than fifty per cent of the reported wind component opposite to the direction of take-off or not less than 150 per cent of the reported wind component in the direction of take-off,

and plotted from a point 35 feet or fifty feet, as appropriate, above the end of the take-off distance required at the aerodrome at which the take-off is to be made to a height of 1,500 feet above the aerodrome, shows that the aeroplane will clear any obstacle in its path by a vertical interval of at least 35 feet, except that if it is intended that the aeroplane shall change its direction of flight by more than 15 the vertical interval shall not be less than fifty feet during the change of direction.

(2) For the purpose of condition 3 (1) of this regulation an obstacle shall be deemed to be in the path of the aeroplane if the distance from the obstacle to the nearest point on the ground below the intended line of flight of the aeroplane does not exceed-

- (a) a distance of 200 feet plus half the wing span of the aeroplane plus one eighth of the distance from such point to the end of the take-off distance available, measured along the intended line of flight of the aeroplane; or
- (b) 5,000 feet,

whichever is the less.

(3) In assessing the ability of the aeroplane to satisfy this condition, it shall not be assumed to make a change of direction of a radius less than the radius of steady turn specified.

**4.** The aeroplane shall, in the meteorological conditions expected for the flight, in the event of any one power unit becoming inoperative at any point on its route or on any planned diversion therefrom and with the other power units or unit operating within the maximum continuous power conditions specified, be capable of continuing the flight, clearing by a vertical interval of at least 2,000 feet obstacles within five nautical miles either side of the intended track, to an aerodrome at which it can comply with condition 7 in this regulation relating to an alternate aerodrome, and on arrival over such aerodrome the gradient of the specified net flight path with one power unit inoperative shall not be less than zero at 1,500 feet above the aerodrome; and in assessing the ability of the aeroplane to satisfy this condition, it shall not be assumed to be capable of flying at an altitude exceeding the specified maximum permissible altitude for power unit restarting.

**5.** The aeroplane shall, in the meteorological conditions expected for the flight, in the event of any two power units becoming inoperative at any point along the route or on any planned diversion there from

more than ninety minutes' flying time in still air at the power units operating economical cruising speed from the nearest aerodrome at which it can comply with condition 7 in this regulation, relating to an alternate aerodrome, be capable of continuing the flight with all other power units operating within the specified maximum continuous power conditions, clearing by a vertical interval of at least 2,000 feet obstacles within five nautical miles either side of the intended track to such an aerodrome, and on arrival over such aerodrome the gradient of the specified net flight path with two power units inoperative shall not be less than zero at 1,500 feet above the aerodrome; and in assessing the ability of the aeroplane to satisfy this condition it shall not be assumed to be capable of flying at an altitude exceeding the specified maximum permissible altitude for power unit restarting.

**6.** The landing weight of the aeroplane will not exceed the maximum landing weight specified for the altitude and the expected air temperature for the estimated time of landing at the aerodrome at which it is intended to land and at any alternate aerodrome.

**7. (1)** The landing distances required, respectively specified as being appropriate to aerodromes of destination and alternate aerodromes, do not exceed at the aerodrome at which it is intended to land or at any alternate aerodrome, as the case may be, the landing distance available on-

- (a) the most suitable runway for a landing in still air conditions; and
- (b) the runway that may be required for landing because of the forecast wind conditions:

Provided that if an alternate aerodrome is designated in the flight plan, the specified landing distance required may be that appropriate to an alternate aerodrome when assessing the ability of the aeroplane to satisfy this condition at the aerodrome of destination in respect of the runway that may be required for landing because of the forecast wind conditions.

**(2)** For the purposes of condition 7 (1) of this regulation the landing distance required shall be that specified as being appropriate to-

- (a) the landing weight;
- (b) the altitude at the aerodrome;
- (c) the temperature in the specified international standard atmosphere appropriate to the altitude at the aerodrome;
- (d) still air conditions in the case of the most suitable runway for a landing in still air conditions;
- (e) not more than fifty per cent of the forecast wind component opposite to the direction of landing or not less than 150 per cent of the forecast wind component in the direction of landing in the case of the runway that may be required for landing because of the forecast wind conditions.

*Weight and performance of public transport aeroplanes classified as aeroplanes of performance group C or of performance group D in their certificates of airworthiness*

## **7. Aircraft of performance groups C and D**

With reference to regulation 24 of the Air Navigation Regulations, an aeroplane registered in Nigeria in respect of which there is in force under those Regulations a certificate of airworthiness in which the aeroplane is designated as being of performance group C or performance group D, shall not fly for the purpose of public transport unless the weight of the aeroplane at the commencement of the take-off run is such that the conditions set out in regulation 8 of these Regulations are satisfied.

## **8. Conditions as to weight of aircraft of performance groups C and D**

The conditions referred to in regulation 7 of these Regulations are as follows-

1. (1) That weight does not exceed the maximum take-off weight specified for the altitude and the air temperature at the aerodrome at which the take-off is to be made.

(2) The take-off run required and the take-off distance required, specified as being appropriate to-

- (a) the weight of the aeroplane at the commencement of the take-off run;
- (b) the altitude at the aerodrome;
- (c) the air temperature at the aerodrome;
- (d) the average slope of the surface of the aerodrome in the direction of take-off over the emergency distance available;
- (e) not more than fifty per cent of the reported wind component opposite to the direction of take-off or not less than 150 per cent of the reported wind component in the direction of take-off,

do not exceed the take-off run available and the emergency distance available, respectively, at the aerodrome at which the take-off is to be made.

(3) The net take-off flight path with all power units operating specified as being appropriate to-

- (a) the weight of the aeroplane at the commencement of the take-off run;
- (b) the altitude at the aerodrome;
- (c) the air temperature at the aerodrome;
- (d) not more than fifty per cent of the reported wind component opposite to the direction of take-off or not less than 150 per cent of the reported wind component in the direction of take-off,

and plotted from a point fifty feet above the end of the take-off distance required at the aerodrome at which the take-off is to be made to the point at which the aeroplane reaches the minimum altitude for safe flight on the first stage of the route to be flown in or calculated from the information contained in the operations manual relating to the aircraft, shows that the aeroplane will clear by a safe margin any obstacle the distance from which to the nearest point on the ground below the intended line of flight of

the aeroplane does not exceed 200 feet plus half the wing span of the aeroplane. In assessing the ability of the aeroplane to satisfy this condition it shall not be assumed to make a change of direction to a radius less than the specified radius of steady turn.

(4) The aeroplane shall, if it is designated in its certificate of airworthiness as an aeroplane of performance group C and if it is necessary for it to be flown solely by reference to instruments for any period before reaching the minimum altitude for safe flight on the first stage of the route to-be flown, stated in, or calculated from the information contained in, the operations manual, during such period also, satisfy condition 3 in regulation 5 of these Regulations.

(5) The aeroplane shall, in the meteorological conditions expected for the flight, in the event of anyone power unit becoming inoperative at any point on its route or on any planned diversion therefrom, and with the other power units or unit, if any, operating within the specified maximum continuous power conditions-

(a) in the case of an aeroplane designated as an aeroplane of performance group C, be capable of continuing the flight at altitudes not less than the relevant minimum altitudes for safe flight stated in, or calculated from the information contained in, the operations manual to a point 1,500 feet above an aerodrome at which a safe landing can be made and after arrival at that point be capable of maintaining that height;

(b) in the case of an aeroplane designated as an aeroplane of performance group D, be capable of continuing the flight to a point 1,000 feet above a place at which a safe landing can be made:

Provided that in assessing the ability of the aeroplane to satisfy this condition it shall not be assumed to be capable of flying at any point on its route at an altitude exceeding the performance ceiling with all power units operating specified as being appropriate to its estimated weight at that point.

(6) The landing weight of the aeroplane shall not exceed the maximum landing weight specified for the altitude and the expected air temperature for the estimated time of landing at the aerodrome at which it is intended to land and at any alternate aerodrome.

(7) The distance required by the aeroplane to land from a height of fifty feet does not, at the aerodrome at which it is intended to land and at any alternate aerodrome, exceed seventy per cent of the landing distance available on the most suitable runway for a landing in still air conditions, or on the runway that may be required for landing because of the forecast wind conditions, and for the purposes of this subparagraph the distance required to land from a height of fifty feet shall be taken to be that specified as being appropriate to-

(a) the landing weight;

(b) the altitude at the aerodrome;

(c) the expected air temperature for the estimated time of landing at the aerodrome;

- (d) a level surface in the case of runways usable in both directions;
- (e) the average slope in the runway in the case of runways usable in only one direction;
- (f) still air conditions in the case of the most suitable runway for a landing in still air conditions;
- (g) not more than fifty per cent of the forecast wind component opposite to the direction of landing or not less than 150 per cent of the forecast wind component in the direction of landing in the case of a runway that may be required for landing because of the forecast wind conditions.

2. An aeroplane designated as aforesaid as an aeroplane of performance group D shall not fly for the purpose of public transport (except for the sole purpose of training persons to perform duties in aircraft) at night or when the cloud ceiling or visibility prevailing at the aerodrome of departure and forecast for the estimated time of landing at the aerodrome at which it is intended to land and at any alternate aerodrome are less than 1,000 feet and one mile respectively.

#### WEIGHT AND PERFORMANCE OF PUBLIC TRANSPORT

*Aeroplanes classified as aeroplanes of performance group X in their certificates of airworthiness*

#### **9. Aircraft of performance group X**

With reference to regulation 24 of the Air Navigation Regulations, an aeroplane in respect of which there is in force under those Regulations a certificate of airworthiness in which the aeroplane is designated as being of performance group X, shall not fly for the purpose of public transport unless the weight of the aeroplane at the commencement of take-off is such that the conditions set out in regulation 10 are satisfied.

#### **10. Condition as to weight of aircraft of performance group X**

The conditions referred to in regulation 9 of these Regulations are as follows-

1. (1) That weight does not exceed the maximum take-off weight specified for the altitude at the aerodrome at which the take-off is to be made, or for the altitude and the air temperature at such aerodrome as the case may be.

(2) The minimum effective take-off runway length required, specified as being appropriate to-

- (a) the weight of the aeroplane at the commencement of the take-off run;
- (b) the altitude at the aerodrome;
- (c) the air temperature at the time of take-off;
- (d) the overall slope of the take-off run available; and



(e) not more than fifty per cent of the reported wind component opposite to the direction of take-off or not less than 150 per cent of the reported wind component in the direction of take-off,

does not exceed the take-off run available at the aerodrome at which the take-off is to be made.

(3) The take-off flight path with one power unit inoperative, specified as being appropriate to-

(a) the weight of the aeroplane at the commencement of the take-off run;

(b) the altitude at the aerodrome; and

(c) not more than fifty per cent of the reported wind component opposite to the direction to take-off or not less than 150 per cent of the reported wind component in the direction of take-off,

and plotted from a point fifty feet above the end of the minimum effective take-off runway length required at the aerodrome at which the take-off is to be made, shows that the aeroplane will thereafter clear any obstacle in its path by a vertical interval of not less than the greater of fifty feet or 35 feet plus one hundredth of the distance from the point on the ground below the intended line of flight of the aeroplane nearest to the obstacle to the end of the take-off distance available, measured along the intended line of flight of the aeroplane.

(4) For the purpose of condition 1 (3) of this regulation, an obstacle shall be deemed to be in the path of the aeroplane if the distance from the obstacle to the nearest point on the ground below the intended line of flight does not exceed-

(a) a distance of 200 feet plus half the wing span of the aeroplane plus one eighth of the distance from such point to the end of the take-off distance available measured along the intended line of flight; or

(b) 5,000 feet,

whichever is the less.

(5) In assessing the ability of the aeroplane to satisfy this condition, in so far as it relates to flight path, it shall not be assumed to make a change of direction of a radius less than the radius of steady turn corresponding to an angle of bank of 15°.

**2. (1)** Subject to condition 1 (2) of this regulation, the weight of the aeroplane at any point on the route or any planned diversion therefrom, having regard to the fuel and oil expected to be consumed up to that point, shall be such that the aeroplane, with one power unit inoperative and the other power unit or units operating within the maximum continuous power conditions specified, will be capable of a rate of climb of at least  $K (V_{so}/100)^2$  feet per minute at an altitude not less than the minimum altitude for the safe flight stated in or calculated from the information contained in the operations manual, where  $V_{so}$  is in knots and  $K$  has the value of  $797 - 1060/N$ ,  $N$  being the number of power units installed.

(2) As an alternative to condition 1 (1) of this regulation, the aeroplane may be flown to an altitude from which, in the event of failure of one power unit, it is capable of reaching an aerodrome where a landing

can be made in accordance with condition 1 (4) in this regulation relating to an alternate aerodrome; and in that case, the weight of the aeroplane shall be such that, with the remaining power unit or units operating within the maximum continuous power conditions specified, it is capable of maintaining a minimum altitude on the route to such aerodrome of 2,000 feet above all obstacles within five nautical miles on either side of the intended track; and

- (a) the rate of climb specified for the appropriate weight and altitude, used in calculating the flight path shall be reduced by an amount equal to  $K (V_{so}/100)^2$  feet per minute;
- (b) the aeroplane shall comply with the climb requirement of condition 2 (1) at 1,000 feet above the chosen aerodrome;
- (c) account shall be taken of the effect of wind and temperature of the flight path; and
- (d) the weight of the aeroplane may be assumed to be progressively reduced by normal consumption of fuel and oil.

(3) An aeroplane having four power units shall, if any two power units become inoperative at any point along the route or any planned diversion therefrom, being a point more than ninety minutes' flying time (assuming all power units to be operating) from the nearest aerodrome at which a landing can be made in compliance with condition 2 (4) of this regulation relating to an alternate aerodrome, be capable of continuing the flight at an altitude of not less than 1,000 feet above ground level to a point above that aerodrome.

(4) The required landing runway lengths respectively specified as being appropriate to the aerodrome of intended destination and the alternate aerodromes, do not exceed at the aerodrome at which it is intended to land or at any alternate aerodrome, as the case may be, the landing distance available on-

- (a) the most suitable runway for a landing in still air conditions; and
- (b) the runway that may be required for landing because of the forecast wind conditions,

the required landing runway lengths being taken to be those specified as being appropriate to-

- (i) the landing weight;
  - (ii) the altitude at the aerodrome;
  - (iii) still air conditions in the case of the most suitable runway for a landing in still air conditions; and
  - (iv) not more than fifty per cent of the forecast wind component opposite to the direction of landing or not less than 150 per cent of the forecast wind component in the direction of landing in the case of the runway that may be required for landing because of the forecast wind conditions.
-

# CIVIL AVIATION (BIRTHS, DEATHS AND MISSING PERSONS)

## REGULATIONS

### ARRANGEMENT OF REGULATIONS

#### REGULATION

1. Short title.
2. Interpretation.
3. Returns relating to births and deaths by owners of aircraft.
4. Records to be kept by Minister.
5. Transmission of copies of entries to appropriate registrar.
6. Determination of appropriate registrar.
7. Saving for father of illegitimate child.
8. Rectification of errors.

#### SCHEDULES

##### FIRST SCHEDULE

*Form of notification of a birth*

##### SECOND SCHEDULE

*Form of a notification of a death*

##### THIRD SCHEDULE

*Record of births*

##### FOURTH SCHEDULE

*Record of deaths*

##### FIFTH SCHEDULE

*Record of missing persons*

---

# CIVIL AVIATION (BIRTHS, DEATHS AND MISSING PERSONS)

## REGULATIONS

[Commencement.]

[1st December, 1965]

### 1. Short title

These Regulations may be cited as the Civil Aviation (Births, Deaths and Missing Persons) Regulations.

## **2. Interpretation**

(1) In these Regulations unless the content otherwise requires-

**"aircraft"** includes all balloons, whether captive or free, gliders, airships and flying machines;

**"journey"** is deemed to commence when a traveller enters an aircraft registered in Nigeria for the purpose of the journey and to continue until that traveller alights therefrom on completion of the journey, notwithstanding any intermediate stop or break in the journey;

**"Minister"** means the Minister responsible for matters relating to civil aviation;

**"missing persons"** means persons with respect to whom there are reasonable grounds for believing that they have died in consequence of an accident occurring in or over Nigeria to an aircraft registered in Nigeria;

**"traveller"**, in relation to an aircraft, includes a member of the crew.

(2) The Interpretation Act shall apply for the purpose of the interpretation of these Regulations as it applies for the purpose of the interpretation of an Act of the National Assembly.

[Cap. 123.]

## **3. Returns relating to births and deaths by owners of aircraft**

(1) The owner of an aircraft registered in Nigeria shall, as soon as is practicable but not later than six months after the occurrence in any part of the world of a birth or death in the aircraft, or a traveller in the aircraft who is killed on the journey in consequence of an accident, transmit to the Minister a return of such birth or death in the form, in accordance with the instructions, and containing the particulars prescribed in the First Schedule to these Regulations (in the case of a birth) or the Second Schedule to these Regulations (in the case of a death):

[First Schedule.]

Provided that if such particulars are not known to the owner of the aircraft, he shall transmit as aforesaid so many of such particulars as he is reasonably able to ascertain having regard to the circumstances of the birth or death.

(2) To facilitate the rendering of returns in accordance with this regulation, the person in command of an aircraft registered in Nigeria shall forthwith on the occurrence in any part of the world of a birth or death in the aircraft, or of the death outside Nigeria of a traveller in the aircraft who is killed on the journey in consequence of an accident, record in the journey log book, or other appropriate document relating to that aircraft, the particulars of such birth or death mentioned in paragraph 1 of this regulation and shall make such record available to the owner as soon as practicable:

Provided that if all such particulars are not known to the person in command of an aircraft and cannot be readily ascertained by him, he shall record and make available as aforesaid so many of such particulars as are readily ascertainable.

(3) Where an aircraft has been *bona fide* demised, let or hired out for a period exceeding fourteen days to any other person by the owner thereof, and no pilot, commander, navigator or operative member of the crew of the aircraft is in the employment of the owner, the provisions of this regulation shall have effect as though for references to the owner there were substituted references to the person to whom the aircraft has been so demised, let, or hired out.

#### **4. Records to be kept by Minister**

The Minister shall keep-

(a) a separate record of births in the form set out in the Third Schedule to these Regulations in which shall be recorded the particulars transmitted to him of births occurring in or over Nigeria in aircraft registered in Nigeria;

[Third Schedule.]

(b) a separate record of deaths in the form in the Fourth Schedule to these Regulations in which shall be recorded the particulars transmitted to him of deaths occurring in or over Nigeria in aircraft registered in Nigeria; and

[Fourth Schedule.]

(c) a separate record in the form in the Fifth Schedule to these Regulations of persons reported to him as missing persons.

[Fifth Schedule.]

#### **5. Transmission of copies of entries to appropriate registrar**

The Minister shall within seven days of the completion of an entry in any record kept in his Ministry pursuant to the provisions of these Regulations cause a certified copy of such entry to be transmitted to the appropriate registrar.

#### **6. Determination of appropriate registrar**

For the purpose of these Regulations, the appropriate registrar shall be ascertained as follows-

(a) where it appears to the Minister that an entry in the record of births relates to the birth of a child the father of whom, or if the child is illegitimate, the mother of whom, was at the time of the birth usually resident in the Federal Capital Territory, Abuja or in any State of the Federation, a certified copy of the entry shall be sent to the Registrar of Births and Deaths in the Federal Capital Territory, Abuja or the State concerned, as the case may require;

(b) where it appears to the Minister that an entry in the record of deaths or missing persons relates to a person who, at the time of his death, or (in the case of a missing person) at the time when he was reported missing, was usually resident in Federal Capital Territory, Abuja or in any State of the Federation, a certified copy of the entry shall be sent to the Registrar of Births and Deaths in the Federal Capital Territory, Abuja or the State concerned, as the case may require;

(c) in every other case, a certified copy of an entry in the record of births, deaths, or missing persons shall be sent to whichever registrar may be thought appropriate.

### **7. Saving for father of illegitimate child**

In the case of the birth of an illegitimate child, the name of any person as father of such child shall not be entered in any return or record of particulars of the birth of such child unless the mother of the child and the person acknowledging himself to be the father of the child shall have signed a completed form of return as informants.

### **8. Rectification of error**

(1) If the Minister is satisfied that there is an error or omission in any entry made in the record of births, deaths or missing persons kept by him pursuant to regulation 4 of these Regulations, he may, in accordance with evidence of the true facts relating to the entry, rectify it in such manner as may appear to him appropriate.

(2) Within seven days after the correction of any entry in his records in accordance with this regulation, the Minister shall cause a certified copy of such corrected entry to be transmitted to the appropriate registrar.

---

#### FIRST SCHEDULE

*(Form of notification of a birth)*

[Regulation 3 (1).]

1. Registration and marking of aircraft .....
2. Date of birth *(a)* .....
3. Place of birth *(b)*.....
4. Sex *(c)* .....
5. Name *(d)* .....
6. Name, surname and nationality or country of father *(e)* .....
7. Maiden name and nationality or country of mother.....

- 8. Date and place of marriage of parents.....
- 9. Rank or occupation and addresses of father (or, in default, of mother) (e).....
- 10. Name, description and address of informant (if any) (f).....
- 11. Signature of informant(s) .....
- Signature and rank of persons completing the return .....
- Date.....

*Notes*

- (a) Day and month in words, year in figures.
- (b) Approximate position, e.g. "40 miles west of Kaduna".
- (c) "Boy" or "Girl" as the case may be.
- (d) Full first names of child.
- (e) First names in full and followed by surname; surname to be written in block letters. If child is illegitimate (see (8) above) the particulars relating to the father must not be recorded in the return unless at the joint request of the mother and of the person acknowledging himself to be the father of the child in which case such person shall, as well as the mother, sign a completed form of return as informant.
- (f) The informant's full names, relationship (if any) to the child, and full postal address should be stated. Except in the circumstances mentioned at (e) above only one person (usually the mother or father) should act as informant.

---

SECOND SCHEDULE

*(Form of notification of a death)*

[Regulation 3 (1).]

- 1. Registration and marking of aircraft.....
- 2. Date of death (a).....
- 3. Place of death (b) .....
- 4. Names and surname (c).....
- 5. Sex (d).....

- 6. Age (*e*) .....
- 7. Rank or occupation (*f*) .....
- 8. Nationality or country.....
- 9. Address or abode (*g*).....
- 10. Cause of death.....
- 11. Name of certifying medical practitioner (if any) .....
- 12. Duration of illness .....
- 13. Place of burial.....
- 14. Signature, description and address of informant (*h*).....
- 15. Date of registration.....
- 16. Signature and rank of person completing the form.....
- Date.....

Notes

- (a) Day and month in words, year in figures.
- (b) Actual position, if known, otherwise approximate position, e.g. "40 miles west of Kaduna".
- (c) First names in full, followed by surname. Surname to be written in block letters.
- (d) "Male" or "Female".
- (e) To be recorded in complete years, or in months or days.
- (f) Women and children

In the case of a married woman or a widow, the words, "wife of" or "widow of" shall be entered, followed by the name, rank of occupation, and nationality of the husband.

In the case of an unmarried woman, there shall be inserted (i) the word "spinster" followed by her profession or occupation (if any), rank or title (if any), and her nationality, and (ii) the words "daughter of" followed by the name, profession, etc., of her father.

In the case of children under the age of sixteen years, the words "son of" or "daughter of" shall be followed by the name, profession, etc., of the father.

- (f) Women and children.



(h) The full postal address should be stated.

(h) The informant's full names, relationship (if any) to deceased, and full postal address should be stated.

---

THIRD SCHEDULE

*Record of births in aircraft registered in Nigeria*

[Regulation 4 (a).]

- (1) Registration and marking of aircraft.....
- (2) Date of birth.....
- (3) Place of birth.....
- (4) Sex of child .....
- (5) Name (if any).....
- (6) Name and nationality or country of father.....
- (7) Maiden name and nationality or country of mother.....
- (8) Rank or occupation and addresses of father (or in default, of mother).....
- (9) Name, description and address of informant.....
- (10) Date of registration.....
- (11) Signature of Minister.....
- (12) Name, if added after registration of birth.....

---

FOURTH SCHEDULE

*Record of death in aircraft registered in Nigeria*

[Regulation 4 (b).]

- (1) Registration and marking of aircraft.....
- (2) Date of death.....
- (3) Place of death .....

- (4) Full name.....
- (5) Sex.....
- (6) Age.....
- (7) Rank or occupation.....
- (8) Nationality or country.....
- (9) Abode.....
- (10) Cause of death.....
- (11) Name of certifying medical practitioner (if any).....
- (12) Duration of illness.....

---

FIFTH SCHEDULE

*Persons missing and believed to have died in consequence of accident to aircraft registered in Nigeria*

[Regulation 4 (c).]

- (1) Registration and marking of aircraft.....
  - (2) Full name of missing person.....
  - (3) Sex .....
  - (4) Age .....
  - (5) Rank or occupation .....
  - (6) Nationality or country .....
  - (7) Address .....
  - (8) Date and place of accident and grounds for presumption of death .....
  - (9) Name, description and address of informant .....
  - (10) Date of registration .....
  - (11) Signature of Minister .....
-

# CIVIL AVIATION RULES OF THE AIR AND AIR TRAFFIC CONTROL

## ARRANGEMENT OF RULES

### RULE

1. Short title.

#### PART I

##### *Interpretation*

2. Interpretation.

#### PART II

##### *General*

3. Application of Rules to aircraft.
4. Misuse of signals and markings.
5. Reporting hazardous conditions.
6. Low flying.
7. Simulated instrument flight.
8. Practice instrument approaches.

#### PART III

##### *Lights and other signals to be shown by aircraft*

9. Lights and other signals to be shown by aircraft.
10. Display of lights of aircraft.
11. Failure of navigation lights.
12. Flying machines.
13. Gliders.
14. Free balloons.
15. Captive balloons and kites.
16. Airships.

#### PART IV

##### *General flight rules*

17. Weather reports and forecasts.
18. Rules for avoiding aerial collisions.
19. Aerobatic manoeuvres.
20. Right-hand traffic rule.
21. Notification of arrival.
22. Flight in notified airspace.
23. Choice of VRF or IFR.

#### PART V

##### *Visual Flight Rules*

24. Visual Flight Rules.

## PART VI

### *Instrument Flight Rules*

- 25. Instrument Flight Rules.
- 26. Minimum height.
- 27. Quadrant rule.
- 28. Flight plan and air traffic control clearance.
- 29. Position reports.
- 30. Communication failure.

## PART VII

### *Aerodrome traffic rules*

- 31. Application of aerodrome traffic rules.
- 32. Visual signals.
- 33. Access to and movement on the manoeuvring area and other parts of the aerodrome used by aircraft.
- 34. Right of way on the ground.
- 35. Dropping of tow ropes, etc.
- 36. Aerodromes not having air traffic control units.
- 37. Aerodromes having air traffic control units.
- 38. Commander's duty at Unit.

## PART VIII

### *Aerodrome signals and markings visual and aural signals*

- 39. Aerodrome signals and markings: visual and aural signals: general.
- 40. Signals in the signals area.
- 41. Markings for paved runways and taxiways.
- 42. Markings on unpaved manoeuvring areas.
- 43. Signals visible from the ground.
- 44. Lights and pyrotechnic signals for control of aerodrome traffic.
- 45. Marshalling signals.
- 46. Distress, urgency and safety signals.
- 47. Warning signals to aircraft in flight.

## PART IX

### *Ground lighting*

- 48. Minimum ground lighting.
- 49. Approach lighting.
- 50. Landing area lights.
- 51. Guidance lights on the manoeuvring area and other parts of the aerodrome used by aircraft.
- 52. Areas unfit for use.
- 53. Landing direction indicator.
- 54. Obstruction lights.

PART X

*Air traffic control*

- 55. Provisions of air traffic control services.
- 56. Licensing of air traffic controllers and student air traffic controllers.
- 57. Prohibition of unlicensed air traffic controllers and student air traffic controllers.

PART XI

*Flight over an area in which search and visual operations would be difficult*

- 58. Flight over an area in which search and rescue operations would be difficult.

---

**CIVIL AVIATION RULES OF THE AIR AND AIR TRAFFIC CONTROL**

under regulation 56 (1) of the Civil Aviation (Air Navigation) Regulations

[Commencement.]

[1st December, 1965]

**1. Short title**

These Rules may be cited as the Civil Aviation Rules of the Air and Air Traffic Control.

PART I

*Interpretation*

**2. Interpretation**

(1) In these Rules, unless the context otherwise requires-

**"aerodrome traffic zone"**, in relation to any aerodrome, means the airspace extending from the aerodrome to a height of 2,000 feet above the level of the aerodrome and within a distance of 3,000 yards of its boundaries, except any part of that airspace which is within the aerodrome traffic zone of another aerodrome which is notified for the purposes of these Rules as being the controlling aerodrome;

**"Air Navigation Regulations"** means the Civil Aviation (Air Navigation) Regulations;

**"air traffic control clearance"** means authorisation by an air traffic control unit for an aircraft to proceed under conditions specified by that unit;

**"anti-collision light"** means a flashing red light showing in all directions for the purpose of enabling the aircraft to be more readily detected by the pilots of distant aircraft;

**"cloud ceiling"**, in relation to an aerodrome, means the distance measured vertically from the notified elevation of that aerodrome to the lowest part of any cloud visible from the aerodrome which is sufficient to obscure more than one half of the sky so visible;

**"flight visibility"** means the visibility forward from the flight deck of an aircraft in flight;

**"ground visibility"** means the horizontal visibility at ground level;

**"IFR flight"** means a flight conducted in accordance with the Instrument Flight Rules of Part VI of these Rules;

**"instrument meteorological conditions"** means weather precluding flight in compliance with the visual flight rules;

**"manoeuvring area"** means the part of an aerodrome provided for the take-off and landing of aircraft and for the movement of aircraft on the surface, excluding any parts of the aerodrome set aside for the embarkation and disembarkation of passengers, the loading and unloading of cargo, or the maintenance or parking of aircraft;

**"night"** means the time between sunset and sunrise, sunset and sunrise being determined at surface level;

**"runway"** means an area, whether or not paved, which is provided for the take-off or landing of aircraft;

**"VFR flight"** means a flight conducted in accordance with the Visual Flight Rules of Part V of these Rules;

**"visual meteorological conditions"** means weather permitting flight in accordance with the Visual Flight Rules.

(2) Subject to the provisions of paragraph (1) of this rule, expressions used in these Rules shall, unless the context otherwise requires, have the same respective meanings as in the Air Navigation Regulations.

[L.N. 15 of 1966.]

(3) The Interpretation Act shall apply for the purpose of the interpretation of these Rules as it applies for the purpose of the interpretation of an Act of the National Assembly.

[Cap. 123.]

PART II

*General*

### **3. Application of Rules to aircraft**

These Rules, in so far as they are applicable in relation to aircraft, shall, subject to the provisions of rule 31 of these Rules, apply in relation to-

- (a) all aircraft within Nigeria; and
- (b) all aircraft registered in Nigeria, wherever they may be.

#### **4. Misuse of signals and markings**

(1) A signal or marking to which a meaning is given by these Rules or which is required by these Rules to be used in circumstances or for a purpose therein specified, shall not be used except with that meaning, or for that purpose.

(2) A person in an aircraft or on an aerodrome or at any place at which an aircraft is taking off or landing shall not make any signal which may be confused with a signal specified in these Rules, and, except with lawful authority, shall not make any signal which he knows or ought reasonably to know to be a signal in use for signalling to or from any naval, military or air force aircraft.

#### **5. Reporting hazardous conditions**

The commander of an aircraft shall, on meeting with hazardous conditions in the course of a flight, or as soon as possible thereafter, send to the appropriate air traffic control unit by the quickest means available information containing such particulars of the hazardous conditions as may be pertinent to the safety of other aircraft.

#### **6. Low flying**

(1) Subject to the provisions of paragraphs (6) and (7) of this rule, an aircraft other than a helicopter shall not fly over any congested area of a city, town or settlement below-

- (a) such height as would enable the aircraft to alight clear of the area and without danger to persons or property on the surface, in the event of failure of a power unit; or
- (b) a height of 1,500 feet above the highest fixed object within 2,000 feet of the aircraft, whichever is the higher.

(2) A helicopter shall not fly below such height as would enable it to alight without danger to persons or property on the surface, in the event of failure of a power unit.

(3) Except with the permission in writing of the Minister and in accordance with any conditions therein specified, a helicopter shall not fly over a congested area of a city, town or settlement below a height of 1,500 feet above the highest fixed object within 2,000 feet of the helicopter.

(4) An aircraft shall not fly-

- (a) over, or within 1,000 yards of, any assembly in the open air of more than 1,000 persons assembled for the purpose of witnessing or participating in any organised event, except with the permission in writing of the Minister and in accordance with any conditions therein specified and with the consent in writing of the organisers of the event; or

(b) below such height as would enable it to alight clear of the assembly in the event of the failure of a power unit:

Provided that where a person is charged with an offence under the Air Navigation Regulations by reason of a contravention of this sub-paragraph, it shall be a good defence to prove that the flight of the aircraft over, or within 1,000 yards of, the assembly was made at a reasonable height and for a reason not connected with the assembly or with the event which was the occasion for the assembly.

[L.N. 15 of 1966.]

(5) An aircraft shall not fly closer than 500 feet to any person, vessel, vehicle or structure.

(6) (a) The alternatives in paragraphs (1) (b) and (3) of this rule shall not apply to an aircraft flying-

(i) on a route notified for the purposes of this rule; or

(ii) on a special VFR flight as defined in rule 24 of these Rules in accordance with instructions given for the purposes of that rule by the appropriate air traffic control unit.

(b) Paragraphs (1) (4) and (5) of this rule shall not apply to an aircraft in the service of the Nigerian Police Force.

(c) Paragraphs (1) (4) and (5) of this rule shall not apply to the flight of an aircraft over or within 1,000 yards of an assembly of persons gathered for the purpose of witnessing an event which consists wholly or principally of an aircraft race or contest or an exhibition of flying, if the aircraft is taking part in such race, contest, or exhibition or is engaged in a flight arranged by or made with the consent in writing of, the organisers of the event.

(d) Paragraph (5) of this rule shall not apply to-

(i) any aircraft while it is landing or taking off in accordance with normal aviation practice;

(ii) any glider while it is hill-soaring.

(7) Nothing in this rule shall prohibit any aircraft from-

(a) taking off, landing or practising approaches to landing; or

(b) flying for the purpose of checking navigational aids or procedures in accordance with normal aviation practice at a Government or licensed aerodrome in Nigeria or at any aerodrome in any other state; or

(c) flying in such a manner as may be necessary for the purpose of saving life:

Provided that in the case of practising approaches to landing as aforesaid such practising is confined to the airspace customarily used by aircraft when landing or taking off in accordance with normal aviation practice at the aerodrome concerned.

(8) Nothing in this rule shall apply to any captive balloon or kite.



## **7. Simulated instrument flight**

(1) An aircraft shall not be flown in simulated instrument flight conditions unless-

(a) the aircraft is fitted with dual controls which are functioning properly;

(b) an additional pilot (in this rule called "a safety pilot") is carried in a second control seat of the aircraft for the purpose of rendering such assistance as may be necessary to the pilot flying the aircraft;

(c) if the safety pilot's field of vision is not adequate both forward and to each side of the aircraft, a third person, being a competent observer, occupies a position in the aircraft from which his field of vision makes good the deficiencies in that of the safety pilot, and from which he can readily communicate with the safety pilot.

(2) For the purposes of paragraph (1) of this rule, the expression "**simulated instrument flight**" means a flight during which mechanical or optical devices are used in order to reduce the field of vision or the range of visibility from the cockpit of the aircraft.

## **8. Practice instrument approaches**

Within Nigeria an aircraft shall not carry out instrument approach practise when flying in visual meteorological conditions unless-

(a) the appropriate air traffic control unit has previously been informed that the flight is to be made for the purpose of instrument approach practise; and

(b) if the flight is not being carried out in simulated instrument flight conditions, a competent observer is carried in such a position in the aircraft that he has an adequate field of vision and can readily communicate with the pilot flying the aircraft.

## **PART III**

### *Lights and other signals to be shown by aircraft*

## **9. Lights and other signals to be shown by aircraft**

(1) For the purposes of this Part of these Rules, the horizontal plane of a light shown by an aircraft means the plane which would be the horizontal plane passing through the source of that light, if the aircraft were in level flight.

(2) Where by reason of the physical construction of an aircraft it is necessary to fit more than one lamp in order to show a light required by this Part of these Rules, the lamps shall be so fitted and constructed that, so far as is reasonably practicable, not more than one such lamp is visible from any one point outside that aircraft.

(3) Where in these Rules a light is required to show through specified angles in the horizontal plane, the lamps giving such light shall be so constructed and fitted that the light is visible from any point in any

vertical plane within those angles throughout angles of 90 above and below the horizontal plane, but, so far as is reasonably practicable, through no greater angle, either in the horizontal plane or the vertical plane.

(4) Where in these Rules a light is required to show in all directions, the lamps giving such light shall be so constructed and fitted that, so far as is reasonably practicable, the light is visible from any point in the horizontal plane and on any vertical plane passing through the source of that light.

#### **10. Display of lights of aircraft**

(1) By night an aircraft shall display such of the lights specified in these Rules as may be appropriate to the circumstances of the case, and shall not display any other lights which might obscure or otherwise impair the visibility of, or be mistaken for, such lights:

Provided that nothing in this paragraph shall prevent the display of an anti-collision light.

(2) A flying machine on a land aerodrome in Nigeria at which aircraft normally land or take off at night shall, unless it is stationary on a part of the aerodrome set aside for the embarkation or disembarkation of passengers, the loading or unloading of cargo or the maintenance or parking of aircraft, display by night the lights which it would be required to display if it were flying, or the lights specified in rule 12 (2) (a) or 12 (2) (c) of these Rules.

#### **11. Failure of navigation lights**

If in Nigeria, in the event of the failure of any light which is required by these Rules to be displayed in flight, the light cannot be immediately repaired or replaced, the aircraft shall land as soon as in the opinion of the commander of the aircraft it can safely do so, unless authorised by the appropriate air traffic control unit to continue its flight.

#### **12. Flying machines**

(1) A flying machine when flying at night shall display lights as follows-

(a) in the case of a flying machine registered in Nigeria having a maximum total weight authorised of more than 12,500 lb., if it was first registered in any country-

(i) before 1 July 1963, it shall display, before 1 July 1965, either the system of lights specified in paragraph 2 (b) of this rule or that specified in paragraph (2) (d), excluding sub-paragraph (ii); and after 30 June 1965, the system of lights specified in paragraph (2) (b);

(ii) on or after 1 July 1963, the system of lights specified in paragraph (2) (b) of this rule;

(b) in the case of a flying machine registered in Nigeria having a maximum total weight authorised of 12,500 lb. or less, anyone of the following systems of lights-

(i) that specified in paragraph (2) (a) of this rule; or

(ii) that specified in paragraph (2) (b); or

(iii) that specified in paragraph (2) (d), excluding sub-paragraph (ii);

(c) in the case of any other flying machine one of the systems of lights specified in paragraph (2) of this rule.

(2) The systems of lights referred to in paragraph (1) of this rule are as follows-

(a) (i) a green light of at least five candles showing to the starboard side through an angle of 110° from dead ahead in the horizontal plane;

(ii) a red light of at least five candles showing to the port side through an angle of 110° from dead ahead in the horizontal plane; and

(iii) a white light of at least three candles showing through angles 70° from dead astern to each side in the horizontal plane, all being steady lights;

(b) (i) lights specified in sub-paragraph (a) of this paragraph; and

(ii) an anti-collision light;

(c) the lights specified in sub-paragraph (a) of this paragraph, but all being flashing lights flashing together;

(d) the lights specified in sub-paragraph (a) of this paragraph, but all being flashing lights flashing together in alternation with one or both of the following-

(i) a flashing white light of at least twenty candles showing in all directions;

(ii) a flashing red light of at least twenty candles showing through angles of 70° from dead astern to each side in the horizontal plane.

(3) If the lamp showing either the red or the green light specified in paragraph (2) (a) of this rule is fitted more than six feet from the wing tip, a lamp may, notwithstanding the provisions of rule 9 (1) of these Rules, be fitted at the wing tip to indicate its position, showing a steady light of the same colour through the same angle.

### **13. Gliders**

A glider, while flying at night, shall display either a steady red light of at least five candles, showing in all directions, or lights in accordance with paragraphs (2) and (3) of rule 12 of these Rules.

### **14. Free balloons**

A free balloon, while flying at night, shall display a steady red light of at least five candles, showing in all directions, suspended not less than fifteen feet and not more than thirty feet below the basket, or if there is no basket, below the lowest part of the balloon.

## **15. Captive balloons and kites**

(1) A captive balloon or kite, while flying at night at a height exceeding 200 feet above the surface, shall display lights as follows-

(a) a group of two steady lights consisting of a white light placed twelve feet above a red light, both being of at least five candles and showing in all directions, the white light being placed not less than fifteen feet or more than thirty feet below the basket, or, if there is no basket, below the lowest part of the balloon or kite;

(b) on the mooring cable, at intervals of not more than 1,000 feet measured from the group of lights referred to in sub-paragraph (a) of this paragraph, groups of two lights of the colour and power and in the relative positions specified in that sub-paragraph, and, if the lowest group of lights is obscured by cloud, an additional group below the cloud base;

(c) on the surface, a group of three flashing lights arranged in a horizontal plane at the apexes of a triangle, approximately equilateral, each side of which measures at least 80 feet; so however that-

(i) one side of the triangle shall be approximately at right angles to the horizontal projection of the cable and shall be delimited by two red lights; and

(ii) the third light shall be a green light so placed that the triangle encloses the object on the surface to which the balloon or kite is moored.

(2) A captive balloon, while flying by day at a height exceeding 200 feet above the surface, shall have attached to its mooring cable at intervals of not more than 600 feet measured from the basket, or, if there is no basket from the lowest part of the balloon, tubular streamers not less than sixteen inches in diameter and six feet in length, and marked with alternate bands of red and white twenty inches wide.

(3) A kite flown in the circumstances referred to in paragraph (2) of this rule, shall have attached to its mooring cable either-

(a) tubular streamers as specified in paragraph (2) of this rule; or

(b) intervals of not more than 300 feet measured from the lowest part of the kite, streamers of not less than 32 inches long and one foot wide at their widest part and marked with alternate bands of red and white four inches wide.

## **16. Airships**

(1) Except as provided in paragraph (2) of this rule, an airship, while flying at night, shall display the following steady lights-

(a) a white light of at least five candles showing through angles of 110° from dead ahead to each side in the horizontal plane;

- (b) a green light of at least five candles showing to the starboard side through an angle of 110° from dead ahead in the horizontal plane;
- (c) a red light of at least five candles showing to the port side through an angle of 110° from dead ahead in the horizontal plane; and
- (d) a white light of at least five candles showing through angles of 70° from dead astern to each side in the horizontal plane.

(2) An airship, while flying at night, shall display, if it is not under command, or has voluntarily stopped its engines, or is being towed, the following steady lights-

- (a) the white lights referred to in sub-paragraphs (a) and (d) of paragraph (1) of this rule;
- (b) two red lights, each of at least five candles and showing in all directions suspended below the control car so that one is at least twelve feet above the other and at least 25 feet below the control car; and
- (c) if the airship is making way but not otherwise, the green and red lights referred to in sub-paragraphs (b) and (c) of paragraph (1) of this rule:

Provided that an airship, while picking up its moorings, notwithstanding that it is not under command, shall display only the lights specified in paragraph (1) of this rule.

(3) An airship, while moored within Nigeria by night, shall display the following lights-

- (a) when moored to a mooring mast, at or near the rear; a white light of at least five candles showing in all directions;
- (b) when moored otherwise than to a mooring mast-
  - (i) a white light of at least five candles showing through angles of 110° from dead ahead to each side in the horizontal plane;
  - (ii) a white light of at least five candles showing through angles of 70° from dead astern to each side in the horizontal plane.

(4) An airship while flying by day, if it is not under command, or has voluntarily stopped its engines, or is being towed, shall display two black balls suspended below the control car so that one is at least twelve feet above the other and at least 25 feet below the control car.

(5) For the purpose of this rule-

- (a) an airship shall be deemed not to be under command when it is unable to execute a manoeuvre which it may be required to execute by or under these Rules;

(b) an airship shall be deemed to be making ways when it is not moored and is in motion relative to the air.

## PART IV

### *General flight rules*

#### **17. Weather reports and forecasts**

(1) Immediately before an aircraft flies, the commander of the aircraft shall examine the current reports and forecasts of the weather conditions on the proposed flight path, being reports and forecasts which it is reasonably practicable for him to obtain, in order to determine whether instrument meteorological conditions prevail or are likely to prevail during any part of the flight.

(2) An aircraft which is unable to communicate by radio with an air traffic control unit at the aerodrome of destination shall not begin a flight to an aerodrome within a control zone if the information which it is reasonably practicable for the commander of the aircraft to obtain indicates that it will arrive at that aerodrome when the ground visibility is less than five nautical miles or the cloud ceiling is less than 1,500 feet, unless the commander of the aircraft has obtained from an air traffic control unit at that aerodrome permission to enter the aerodrome traffic zone.

#### **18. Rules for avoiding aerial collisions**

##### *(1) General-*

(a) notwithstanding that the flight is being made with air traffic control clearance, it shall remain the duty of the commander of an aircraft to take all possible measures to ensure that his aircraft does not collide with any other aircraft;

(b) an aircraft shall not be flown in such proximity to other aircraft as to create danger of collision;

(c) aircraft shall not fly in formation unless the commanders of the aircraft have agreed to do so;

(d) an aircraft which is obliged by these Rules to give way to another aircraft shall avoid passing over or under the other aircraft, or crossing ahead of it, unless passing well clear of it;

(e) an aircraft which has the right of way under this rule shall maintain its course and speed,

and for the purposes of this rule a glider and a flying machine which is towing it shall be considered to be a single aircraft under the command of the commander of the towing flying machine.

##### *(2) Converging-*

(a) subject to the provisions of paragraphs (3) and (4) of this rule, an aircraft in the air shall give way to other converging aircraft as follows-

(i) flying machines shall give way to airships, gliders and balloons;

(ii) airships shall give way to gliders and balloons;

(iii) gliders shall give way to balloons;

(b) subject to the provisions of sub-paragraph (a) of this paragraph, when two aircraft are converging in the air at approximately the same altitude, the aircraft which has the other on its right shall give way:

Provided that mechanically driven aircraft shall give way to aircraft which are towing other aircraft or objects.

(3) *Approaching head-on.* When two aircraft are approaching head-on or approximately so in the air and there is danger of collision, each shall alter its course to the right.

(4) *Overtaking.* An aircraft which is being overtaken in the air shall have the right of way and the overtaking aircraft, whether climbing, descending or in horizontal flight, shall keep out of the way of the other aircraft by altering course to the right, and shall not cease to keep out of the way of the other aircraft until that other aircraft has been passed and is clear, notwithstanding any change in the relative positions of the two aircraft:

Provided that a glider overtaking another glider in Nigeria may alter its course to the right or to the left.

(5) *Landing.* An aircraft while landing or on final approach to land shall have the right of way over other aircraft in flight or on the ground or water.

(6) *Two or more aircraft landing.* In the case of two or more flying machines or gliders approaching any place for the purpose of landing, the aircraft at the lower altitude shall have the right of way, but it shall not cut in front of another aircraft which is on final approach to land or overtake that aircraft:

Provided that-

(a) when an air traffic control unit has communicated to any aircraft an order of priority for landing, the aircraft shall approach to land in that order; and

(b) when the commander of an aircraft is aware that another aircraft is making an emergency landing, he shall give way to that aircraft, and at night, notwithstanding that he may have received permission to land, shall not attempt to land until he has received further permission to do so.

## **19. Aerobatic manoeuvres**

An aircraft shall not carry out any aerobatic manoeuvre-

(a) over the congested area of any city, town or settlement; or

(b) within controlled airspace without the consent of the appropriate air traffic control unit.

## **20. Right-hand traffic rule**

An aircraft which is flying within Nigeria in sight of the ground and following a road, railway, canal or coastline, or any other line of landmarks, shall keep such line of landmarks on its left.

### **21. Notification of arrival**

(1) The commander of an aircraft entering or leaving Nigeria on any flight for which a flight plan has been submitted shall take all reasonable steps to ensure upon landing that notice of the arrival of the aircraft is given to the aerodrome of departure.

(2) The commander of an aircraft who has caused notice of its intended arrival at any aerodrome to be given to the air traffic control unit or other authority at that aerodrome shall be informed as quickly as possible of any change of intended destination and any estimated delay in arrival of 45 minutes or more.

### **22. Flight in notified airspace**

In relation to flight in visual meteorological conditions in controlled airspace notified for the purposes of this rule, the commander of an aircraft shall comply with rules 28, 29, and 30 of these Rules as if the flights were IFR flights:

Provided that the commander of the aircraft shall not elect to continue the flight in compliance with the Visual Flight Rules for the purposes of paragraph (3) of rule 28 of these Rules.

### **23. Choice of VRF or IFR**

Subject to the provisions of rule 21 of these Rules, an aircraft shall always be flown in accordance with the Visual Flight Rules or the Instrument Flight Rules:

Provided that in Nigeria an aircraft flying at night shall be flown in accordance with the Instrument Flight Rules, or, in a control zone, in accordance with the Instrument Flight Rules or the provisions of the proviso to paragraph (b) of rule 24 of these Rules.

## **PART V**

### *Visual Flight Rules*

### **24. Visual Flight Rules**

(1) The Visual Flight Rules shall be as follows-

(a) *Outside controlled airspace.* An aircraft flying outside controlled airspace shall remain at least one nautical mile horizontally and 1,000 feet vertically away from cloud and in a flight visibility of at least three nautical miles:

Provided that at or below 3,000 feet above mean sea level this paragraph shall be deemed to be complied with if the aircraft is flown clear of cloud and in sight of the surface;



(b) *Within controlled airspace.* An aircraft flying within controlled airspace shall remain at least one nautical mile horizontally and 1,000 feet vertically away from cloud and in a flight visibility of at least three nautical miles:

Provided that in a control zone, in the case of a special VFR flight, the aircraft shall be flown in accordance with any instructions given by the appropriate air traffic control unit.

(2) For the purpose of this rule, "**special VFR flight**" means a flight made in instrument meteorological conditions or at night or in controlled air space notified for the purposes of rule 21 of these Rules, in respect of which the appropriate air traffic control unit has given permission for the flight to be made in accordance with special instructions given by that unit instead of in accordance with the Instrument Flight Rules.

## PART VI

### *Instrument Flight Rules*

#### **25. Instrument Flight Rules**

The Instrument Flight Rules shall be as follows-

(a) *Outside controlled airspace.* In relation to flights outside controlled airspace rules 26 and 27 of these Rules shall apply.

(b) *Within controlled airspace.* In relation to flights within controlled airspace, rules 26, 28, 29 and 30 of these Rules shall apply.

#### **26. Minimum height**

Without prejudice to the provisions of rule 6 of these Rules, in order to comply with the Instrument Flight Rules an aircraft shall not fly at a height of less than 1,000 feet above the highest obstacle within a distance of five nautical miles of the aircraft unless flying on a route notified for the purposes of this rule or otherwise authorised by the competent authority or unless it is necessary to do so in order to take off or land.

#### **27. Quadrant rule**

In order to comply with the Instrument Flight Rules an aircraft, when in level flight above 3,000 feet above mean sea level outside controlled airspace, shall be flown at a level appropriate to its magnetic track, in accordance with the appropriate table set forth in this rule; and the level of flight shall be measured by an altimeter set according to the system notified, or in the case of flight over a country other than Nigeria, otherwise published by the competent authority, in relation to the area over which the aircraft is flying:

Provided that no aircraft may be flown at a level other than the level required by this rule if it is flying in conformity with instructions given by an air traffic control unit or in accordance with holding procedures notified in relation to an aerodrome.

**TABLE I**

*Lights at levels below 29, 000 feet*

<i>Magnetic track</i>	<i>Cruising Level</i>
Less than 90° .....	Odd thousands of feet
90° but less than 180° .....	Odd thousands of feet + 500 feet
180° but less than 270° .....	Even thousands of feet
270° but less than 360° .....	Even thousands of feet + 500 feet

**TABLE II**

*Flights at levels of 29, 000 feet and above*

<i>Magnetic track</i>	<i>Cruising Level</i>
Less than 90° .....	29,000 feet or higher levels at intervals of 4,000 feet
90° but less than 180° .....	30,000 feet or higher levels at intervals of 4,000 feet
180° but less than 270° .....	31,000 feet or higher levels at intervals of 4,000 feet
270° but less than 360° .....	32,000 feet or higher levels at intervals of 4,000 feet

**28. Flight plan and air traffic control clearance**

(1) In order to comply with the Instrument Flight Rules, before an aircraft either takes off from a point within any controlled airspace or enters any controlled airspace, the commander of the aircraft shall cause a flight plan to be communicated to the appropriate air traffic control unit and shall obtain an air traffic control clearance based on such flight plan.

(2) The flight plan shall contain such particulars of the intended flight as may be necessary to enable the air traffic control unit to issue an air traffic control clearance, or for search and rescue purposes.

(3) The commander of the aircraft shall fly in conformity with the air traffic control clearance issued for the flight as amended by any further instructions given by an air traffic control unit, and with the holding and instrument approach procedures, notified in relation to the aerodrome of destination, unless-

(a) he is able to fly in uninterrupted visual meteorological conditions for so long as he remains in controlled airspace; and

(b) he has informed the appropriate air traffic control unit of his intention to continue the flight in compliance with Visual Flight Rules and has requested that unit to cancel his flight plan:

Provided that if an emergency arises which requires an immediate deviation from air traffic control clearance, the commander of the aircraft shall, as soon as possible, inform the appropriate air traffic control unit of the deviation.

(4) The commander of the aircraft after it has flown in controlled airspace shall, unless he has requested the appropriate air traffic control unit to cancel his flight plan, forthwith inform that unit when the aircraft lands within or leaves the controlled airspace.

### **29. Position reports**

In order to comply with the Instrument Flight Rules, the commander of an aircraft in IFR flight who flies in or is intending to enter controlled airspace, shall report to the appropriate air traffic control unit, the time, and the position and altitude of the aircraft at such reporting points or at such intervals of time as may be notified for this purpose or as may be directed by the air traffic control unit.

### **30. Communication failure**

In order to comply with the Instrument Flight Rules, the commander of an aircraft flying in controlled airspace who is unable to establish or maintain two-way communication with the appropriate air traffic control unit, shall-

(a) continue to fly to his destination, if it is possible to do so by flying only in conditions not inferior to those specified in paragraph (b) of rule 24 of these Rules; or

(b) if he has received and acknowledged an air traffic control clearance to fly to his destination or to enter the controlled airspace in which it lies and sufficient navigational assistance is obtainable to enable him to comply with such clearance-

(i) continue to fly in compliance with the current flight plan to the holding point at the aerodrome of destination, maintaining the last acknowledged cruising levels for the portion of the route for which levels have been specified in the clearance, and thereafter the cruising levels shown in the flight plan;

(ii) arrange the flight to arrive over the holding point as closely as possible to the last acknowledged estimated time of arrival;

(iii) begin to descend over the holding point at the last acknowledged expected approach time, or, if no such expected approach time has been acknowledged, the last acknowledged estimated time of arrival;

(iv) land within thirty minutes of the time at which the descent should have been started; or

(c) if he is unable to comply with the provisions of paragraph (a) or (b) of this rule, leave or avoid controlled airspace either-

(i) fly to an area in which flight may be continued in visual meteorological conditions, and land at an aerodrome there; or

(ii) select a suitable area in which to descend through cloud, and land at an aerodrome there.

## PART VII

### *Aerodrome traffic rules*

#### **31. Application of aerodrome traffic rules**

The Rules in this Part of these Rules which are expressed to apply to flying machines shall also be observed, so far as is practicable, in relation to all other aircraft.

#### **32. Visual signals**

The commander of a flying machine on, or in the traffic zone of an aerodrome, shall observe such visual signals as may be displayed at, or directed to him from, the aerodrome by the authority of the person in charge of the aerodrome and shall obey any instructions which may be given to him by means of such signals:

Provided that he shall not be required to obey the signals referred to in rule 45 of these Rules (marshalling signals) if in his opinion it is inadvisable to do so in the interests of safety.

#### **33. Access to and movement on the manoeuvring area and other parts of the aerodrome used by aircraft**

(1) A person or vehicle shall not go on to any part of an aerodrome provided for the use of aircraft and under the control of the person in charge of the aerodrome without the permission of the person in charge of the aerodrome, and except in accordance with any conditions subject to which that permission may have been granted.

(2) A vehicle shall not move on the manoeuvring area of an aerodrome having an air traffic control unit without the permission of that unit, and except in accordance with any conditions subject to which that permission may have been granted.

(3) Any permission granted for the purposes of this rule, may be granted either in respect of persons or vehicles generally, or in respect of any particular person or vehicle or any class of person or vehicle.

#### **34. Right of way on the ground**

(1) This rule shall apply to-

- (a) flying machines; and
- (b) vehicles,

on any part of a land aerodrome provided for the use of aircraft and under the control of the person in charge of the aerodrome.

(2) Notwithstanding any air traffic control clearance, it shall remain the duty of the commander of an aircraft to take all possible measures to ensure that his aircraft does not collide with any other aircraft or with any vehicle.

(3) (a) Flying machines and vehicles shall give way to aircraft which are taking off or landing.

(b) Vehicles and flying machines, which are not taking off or landing, shall give way to vehicles towing aircraft.

(c) Vehicles which are not towing aircraft shall give way to aircraft.

(4) Subject to the provisions of paragraph (3) of this rule and of paragraph (3) (b) of rule 36 of these Rules, in case of danger of collision between two flying machines-

(a) when the two flying machines are approaching head-on or approximately so, each shall alter its course to the right;

(b) when the two flying machines are on converging courses, the one which has the other on its right shall give way to the other and shall avoid crossing ahead of the other unless passing well clear of it;

(c) a flying machine which is being overtaken shall have the right of way, and the overtaking flying machine shall keep out of the way of the other flying machine by altering its course to the left until that other flying machine has been passed and is clear, notwithstanding any change in the relative positions of the two flying machines.

(5) Subject to the provisions of paragraph (3) (b) of this rule a vehicle shall-

(a) overtake another vehicle so that the other vehicle is on the left of the overtaking vehicle;

(b) keep to the left when passing another vehicle which is approaching head-on or approximately so.

### **35. Dropping of tow ropes, etc.**

Tow ropes, banners or similar articles towed by aircraft shall not be dropped from aircraft except at an aerodrome and-

(a) in accordance with arrangements made with an air traffic control unit at the aerodrome or, if there is no such unit, with the person in charge of the aerodrome; or

(b) in the area designated by the marking described in paragraph (7) of rule 42 of these Rules, and the ropes, banners, or similar articles shall be dropped when the aircraft is flying in the direction appropriate for landing.

### **36. Aerodromes not having air traffic control units**

(1) (a) An aircraft shall not fly within a zone which the commander of the aircraft knows or ought reasonably to know to be the aerodrome traffic zone of an aerodrome where no air traffic control unit is for the time being notified as being on watch, except for the purpose of taking off or landing at that aerodrome or observing the signals in the signals area with a view to landing there, unless he has the permission of the person in charge of the aerodrome.

(b) An aircraft flying within such a zone for the purpose of observing the signals, shall remain clear of cloud and at least 500 feet above the level of the aerodrome.

(2) The commander of an aircraft flying in such a zone or moving on such an aerodrome shall-

(a) conform to the pattern of traffic formed by other aircraft, or keep clear of the airspace in which the pattern is formed;

(b) make all turns to the left unless ground signals otherwise indicate; and

(c) take off and land in the direction indicated by the ground signals, or if no such signals are displayed, into the wind, unless good aviation practice demands otherwise.

(3) (a) A flying machine or glider shall not land on a runway at such an aerodrome unless the runway is clear of other aircraft.

(b) Where take offs and landings are not confined to a runway-

(i) a flying machine or glider when landing shall leave clear on its left any aircraft which has already landed or is already landing or is about to take off; and if such a flying machine or glider is obliged to turn, it shall turn to the left after the commander of the aircraft has satisfied himself that such action will not interfere with other traffic movements; and

(ii) a flying machine about to take off shall take up position and manoeuvre in such a way as to leave clear on its left any aircraft which is already taking off or is about to take off.

(4) A flying machine, after landing, shall move clear of the landing area in use as soon as it is possible to do so.

### **37. Aerodromes having air traffic control units**

(1) An aircraft shall not fly within a zone which the commander of the aircraft knows or ought reasonably to know to be the aerodrome traffic zone of an aerodrome where an air traffic control unit is for the time being notified as being on watch, except for the purpose of taking off or landing at that

aerodrome, or observing the signals in the signals area with a view to landing there, unless he has the permission of the appropriate air traffic control unit.

(2) The commander of an aircraft flying in the aerodrome traffic zone of an aerodrome where an air traffic control unit is for the time being notified as being on watch, or moving on the manoeuvring area of such an aerodrome, shall-

(a) cause a continuous watch to be maintained on the appropriate radio frequency, notified for air traffic control communications at the aerodrome, or, if this is not possible, cause a watch to be kept for such instructions as may be issued by visual means;

(b) not taxi at the aerodrome or take off or land anywhere in the zone except with the permission of the air traffic control unit;

(c) comply with the provisions of paragraphs 1 (b), (2), (3) and (4) of rule 3 of these Rules as if the aerodrome did not have an air traffic control unit, unless he has permission of the air traffic control unit at the aerodrome, or has been instructed by that unit, to do otherwise.

### **38. Commander's duty at unit**

Without prejudice to the provisions of rules 21 and 28 of these Rules, the commander of an aircraft shall, immediately upon arrival at, or prior to departure from, an aerodrome within Nigeria having an air traffic control unit, ensure that such unit is informed of the flight which he has just made or which he is about to undertake.

## **PART VIII**

### *Aerodrome signals and markings visual and aural signals*

#### **39. Aerodrome signals and markings: visual and aural signals: general**

(1) Whenever any signal specified in this Part of these Rules is given or displayed, or whenever any marking so specified is displayed by any person in an aircraft, or at an aerodrome, or at any other place which is being used by aircraft for landing or take-off, it shall, when given or displayed in Nigeria, have the meaning assigned to it in this Part of these Rules.

(2) All dimensions specified in this Part of these Rules shall be subject to a tolerance of ten per cent, plus or minus.

#### **40. Signals in the signals area**

(1) When any signal specified and illustrated in the following paragraphs of this rule is displayed, it shall be placed in a signals area, which shall be a square visible in all directions bordered by a white strip one foot wide the internal sides measuring forty feet.

(2) A white landing T, as illustrated by Fig. 1 in this paragraph, signifies that aeroplanes and gliders taking off or landing shall do so in a direction parallel with the shaft of the T and towards the cross arm, unless otherwise authorised by the appropriate air traffic control unit.

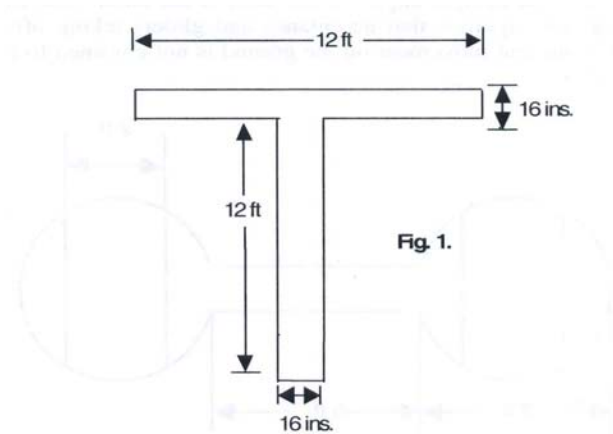

(3) A white disc two feet in diameter displayed alongside the cross arm of the T and in line with the shaft of the T, as illustrated by Fig. 2 in this paragraph, signifies that the direction of the landing and take-offs do not necessarily coincide.

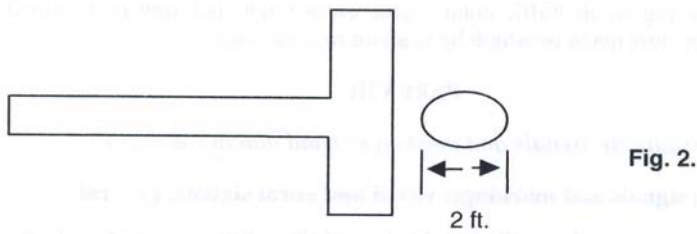

(4) A white dumb-bell, as illustrated by Fig. 3 in this paragraph, signifies that movements of aeroplanes and gliders on the ground shall be confined to paved, metalled or similar hard surfaces.

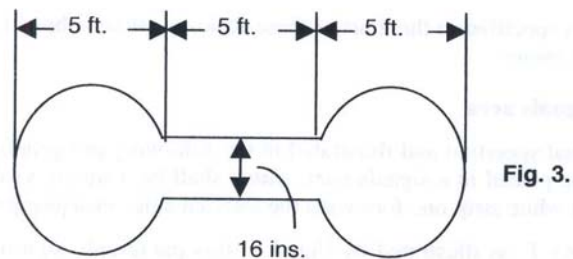

(5) A white dumb-bell as described in paragraph (4) of this rule but with a black strip two feet wide across each disc at right angles to the shaft of the dumb-bell, as illustrated by Fig. 4 in this paragraph,



signifies that aeroplanes and gliders taking off or landing shall do so on a runway but that movement on the ground is not confined to paved, metalled or similar hard surfaces.

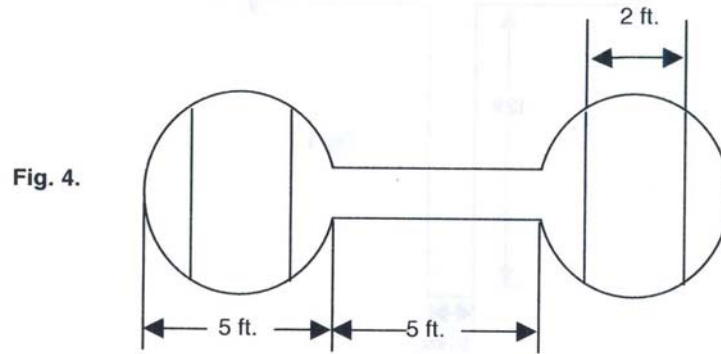

(6) A red and yellow striped arrow, as illustrated by Fig. 5 in this paragraph, the shaft of which is at least three feet wide, placed along the whole or not less than a total of 36 feet of two adjacent sides of the signals area and pointing in a clockwise direction, signifies that a right-hand circuit is in force.

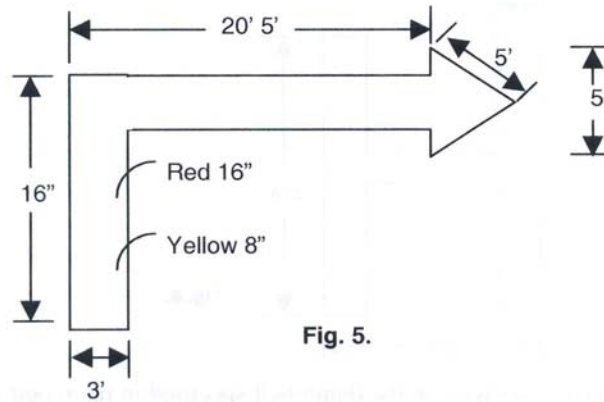

(7) A red panel ten feet square with a yellow strip along one diagonal at least twenty inches wide, as illustrated by Fig. 6 in this paragraph, signifies that the state of the manoeuvring area is poor and that pilots must exercise special care when landing.

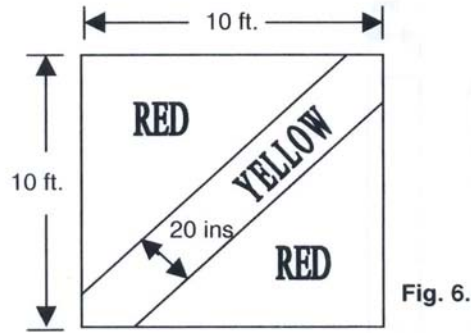

(8) A red panel ten feet square with a yellow strip at least twenty inches wide, along each diagonal, as illustrated by Fig. 7 in this paragraph, signifies that the aerodrome is unsafe for the movement of aircraft and that landing on the aerodrome is prohibited.

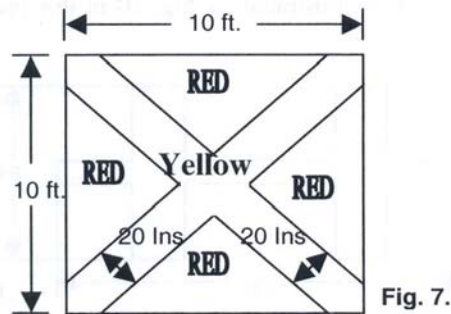

(9) A white letter H, as illustrated by Fig. 8 in this paragraph, signifies that helicopters shall take off and land only within the area designated by the marking specified in paragraph (5) of rule 42 of these Rules.

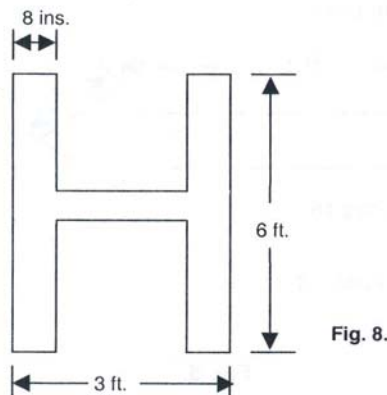

(10) A red letter L displayed on the dumb-bell specified in paragraphs (4) and (5) of this rule, as illustrated by Fig. 9 in this paragraph, signifies that light aircraft are permitted to take off and land either

on a runway or on the area designated by the marking specified in paragraph (6) of rule 42 of these Rules.

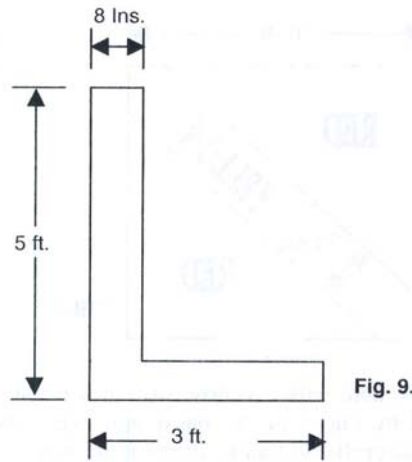

(11) A white double cross as illustrated by Fig. 10 in this paragraph, signifies that glider flying is in progress.

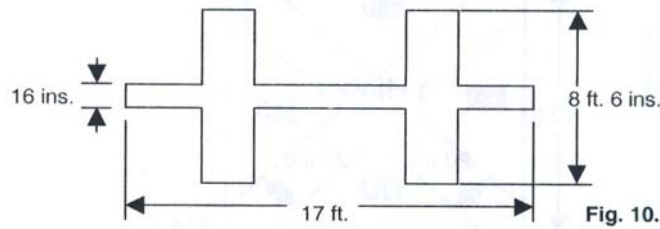

#### 41. Markings for paved runways and taxiways

(1) Two or more white crosses, as illustrated by Fig. 11 in this paragraph, displayed on a runway or taxiway, with the arms of the crosses at an angle of 45° to the centre line of the runway, at intervals of not more than 1,000 feet, signify that the section of runway or taxiway marked by them is unfit for the movement of aircraft.

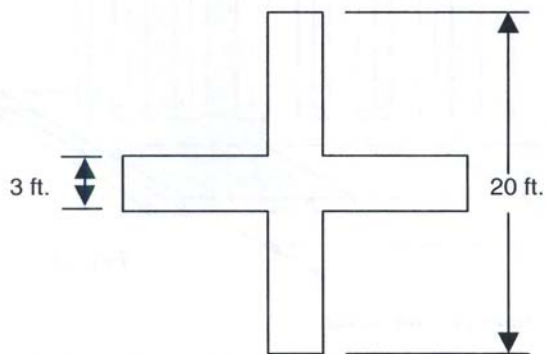

Fig. 11.

(2) A broken white line and a continuous white line, as illustrated by Fig. 12 in this paragraph, signify the holding position beyond which no part of an aircraft or vehicle shall project in the direction of the runway without permission from an air traffic control unit.

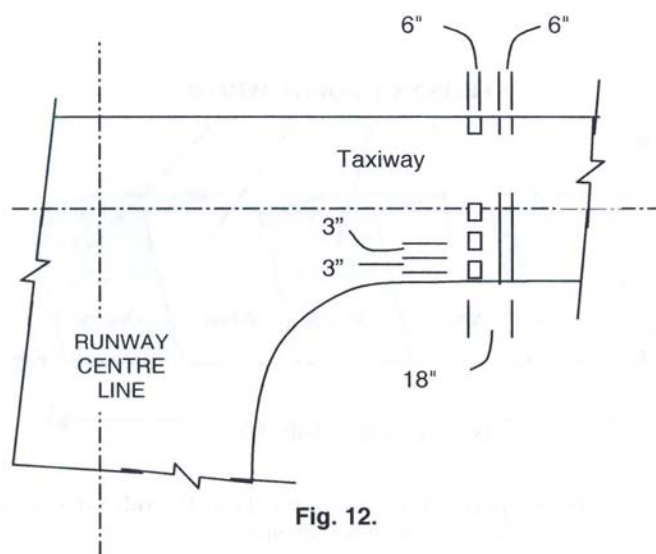
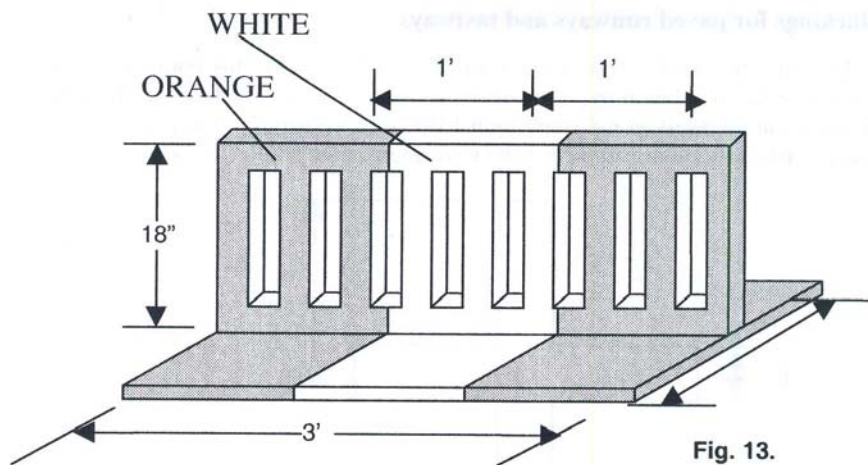

Fig. 12.

(3) Orange and white markers, as illustrated by Fig. 13, spaced not more than 150 feet apart, signify the boundary of that part of a paved runway, taxiway or apron which is unfit for the movement of aircraft.



#### 42. Markings on unpaved manoeuvring areas

(1) Markers with orange and white stripes of an equal width of not less than one and a half feet, with an orange stripe at each end, as illustrated by Fig. 14 in this paragraph, alternating with flags not less than two feet square showing equal orange and white triangular areas, indicate the boundary of an area unfit for the movement of aircraft and one or more white crosses as specified in paragraph (1) of rule 41 of these Rules indicate the said area, but the distance between any two successive orange and white flags shall not exceed 300 feet.

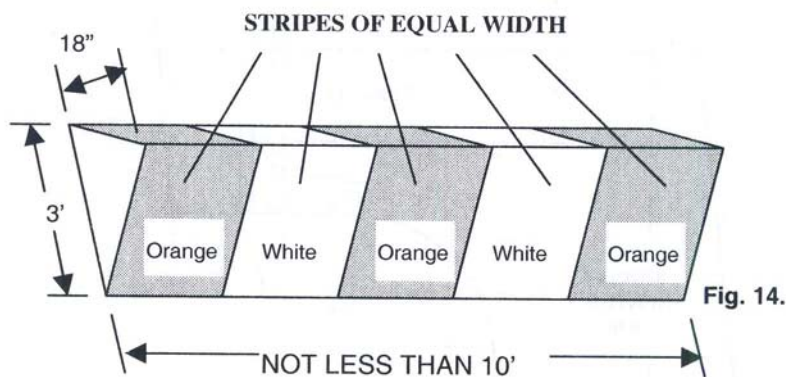

(2) Striped markers, as specified in paragraph (1) of the rule, spaced not more than 150 feet apart, indicate the boundary of an aerodrome.

(3) On structures, markers with orange and white vertical stripes of an equal width of not less than one and a half feet, with an orange stripe at each end, as illustrated by Fig. 15 in this paragraph, spaced not more than 150 feet apart, indicate the boundary of an aerodrome. The pattern of the marker shall be visible from inside and outside the aerodrome and the marker shall be axed not more than six inches from the top of the structure.

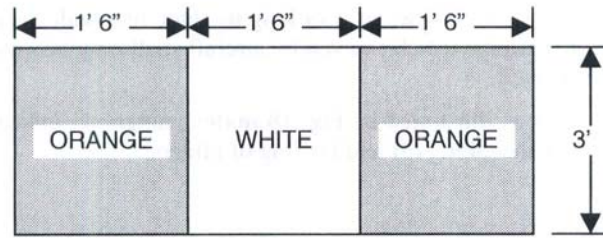

Fig. 15.

(4) White flat rectangular markers ten feet long and three feet wide at intervals not exceeding 300 feet, flush with the surface of the unpaved runway or stopway, as the case may be, indicate the boundary of an unpaved runway or a stopway.

(5) A white letter H, as illustrated by Fig. 16 in this paragraph, indicates an area which shall be used only for taking off and landing of helicopters.

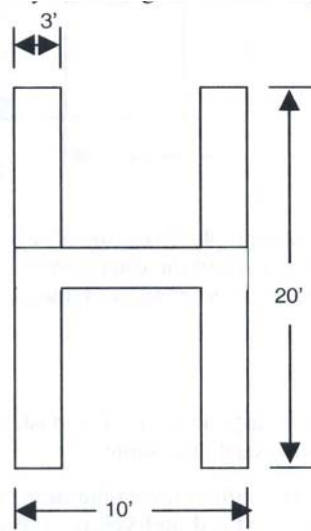

Fig. 16.

(6) A white letter L, as illustrated by Fig. 17 in this paragraph, indicates a part of the manoeuvring area which shall be used only for the taking off and landing of light aircraft.

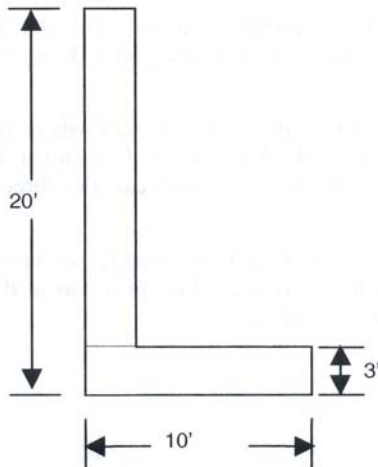

Fig. 17.

(7) A yellow cross, with two arms twenty feet long by three feet wide at right angles, indicates that tow ropes and similar articles towed by aircraft shall only be dropped in the area in which the cross is placed.

(8) A white double cross as illustrated by Fig. 18 in this paragraph, indicates an area which shall be used only for the taking off and landing of gliders.

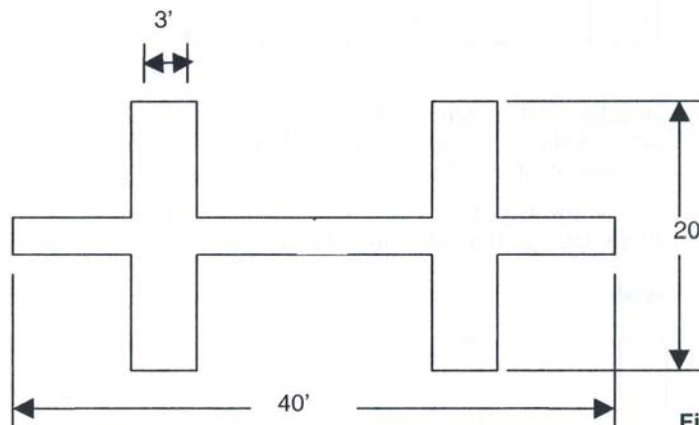

Fig. 18.

(9) A white landing T as specified in paragraph (2) of rule 40 of these Rules placed at the left-hand side of the runway when viewed from the direction of landing, indicates the runway to be used, and at an aerodrome with no runway it indicates the direction for take-off and landing.

#### 43. Signals visible from the ground

(1) A black ball, two feet in diameter, suspended from a mast, signifies that the directions of take-off and landing are not necessarily the same.

(2) A checkered flag or board, four feet by three feet containing twelve equal squares, four horizontally and three vertically, coloured red and yellow alternately, signifies that aerodrome traffic on the

manoeuvring area is subject to control by means of the lights and pyrotechnic signals referred to in rule 44 of these Rules.

(3) Two red balls, two feet in diameter, disposed vertically one above the other, two feet apart and suspended from a mast, signify that glider flying is in progress at the aerodrome.

(4) Black arabic numerals in two-figure groups and, where parallel runways are provided, the letter or letters L (left), LC (left centre), C (centre), RC (right centre) and R (right), placed against a yellow background, indicate the direction for take-off or the runway in use.

(5) A black letter C against a yellow background, as illustrated by Fig. 19 in this paragraph, indicates the position at which a pilot can report to the air traffic control unit or to the person in charge of the aerodrome.

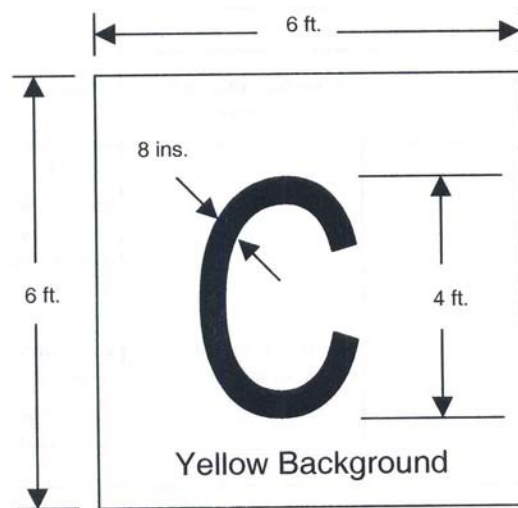

Fig. 19.

(6) A rectangular green flag of not less than two feet square flown from a mast indicates that right-hand circuit is in force.

#### 44. Lights and pyrotechnic signals for control of aerodrome traffic

Each signal described in the first column of Table A, when directed from an aerodrome to an aircraft or to a vehicle, or from an aircraft, shall have the meanings respectively appearing in the second, third and fourth columns of that Table opposite the description of the signal.



<i>Characteristic and colour of light beam or pyrotechnic</i>	<i>From an aerodrome</i>		<i>From an aircraft in flight to an aerodrome</i>
	<i>to an aircraft in flight</i>	<i>to an aircraft or vehicle on aerodrome</i>	
Continuous red light	Do not land; wait for permission	Stop	—
Red pyrotechnic light or red flare	Do not land; wait for permission	—	—
Red flashes	Do not land; aerodrome not available for landing	Move clear of landing area	—
Green flashes	Return to aerodrome; wait for permission to approach and land	You may move on manoeuvring area	—
Continuous green light	You may land	You may take off (not applicable to a vehicle)	—

#### **45. Marshalling signals**

Each of the signals for the guidance of aircraft manoeuvring on the ground, described in the first column of Table B, shall, in Nigeria have the meaning set forth in the second column of that Table opposite the description of the signal; and by day any such signals shall be given by hand or by circular bats and by night by torches or illuminated wands.





Characteristic and colour of light beam or pyrotechnic	From an aerodrome		From an aircraft in flight to an aerodrome
	to an aircraft in flight	to an aircraft or vehicle on aerodrome	
Continuous green light, or green flashes, or green pyrotechnic light	—	—	By night: May I land? By day: May I land in direction different from that indicated by landing T?
White flashes	—	Return to starting point on the aerodrome	I am compelled to land immediately
White pyrotechnic lights switching on and off the navigation lights	—	—	I am compelled to land immediately







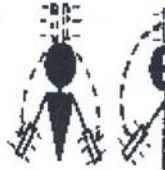







#### 45. Marshalling signals







Each of the signals for the guidance of aircraft manoeuvring on the ground, described in the first column of Table B, shall, in Nigeria have the meaning set forth in the second column of that Table opposite the description of the signal; and by day any such signals shall be given by hand or by circular bats and by night by torches or illuminated wands.

TABLE B

#### Meaning of Marshalling Signals (Rule 45)

Description of Signal	Meaning of Signal	In daylight	By night
(a) Right of left arm down, the other arm moved across the body and extended to indicate position of the other marshaller.	Proceed under guidance of another marshaller.		
(b) Arms repeatedly moved upward and backward, beckoning onward.	Move ahead.		
(c) Right arm down, left arm repeatedly moved upward and backward. The speed of arm movement indicates the rate of turn.	Open up starboard engine or turn to port.		

<i>Description of Signal</i>	<i>Meaning of Signal</i>	<i>In daylight</i>	<i>By night</i>
(d) Left arm down, the right arm repeatedly moved upward and backward. The speed of arm movement indicates the rate of turn.	Open up port engine or turn to starboard.		
(e) Arm repeatedly crossed above the head. The speed of arm movement indicates the urgency of the stop.	Stop.		
(f) A circular motion of the right hand at head level, with the left arm pointing to the appropriate engine.	Start engine.		
(g) Arms extended, the palms facing inwards, then swung from the extended position inwards.	Insert chocks.		
(h) Arms down, the palms facing outwards, then swung outwards.	Chocks away.		
(i) Either arm and hand placed level with the chest, then moved laterally with the palm downwards.	Cut engine.		
(k) Arms placed down, with the palms towards the ground, then moved up and down several times.	Slow down.		

Description of Signal	Meaning of Signal	In daylight	By night
(l) Arms placed down, with the palms towards the ground, then either the right or left arm moved up and down indicating that the motors on the left or right side, as the case may be, should be slowed down.	Slow down engines indicated side.		
(m) Arms placed above the head in a vertical position.	This bay.		
(n) The right arm raised at the elbow, with the arm facing forward.	All clear: Marshalling finished.		

#### 46. Distress, urgency and safety signals

(1) The following signals, given either together or separately before the sending of a message, signify that an aircraft is threatened by grave and imminent danger and requests immediate assistance-

(a) by radiotelephony-

the spoken word "MAYDAY";

(b) by visual signalling-

(i) the signal SOS ( ... --- ... );

(ii) a succession of pyrotechnic lights fired at short intervals each showing a single red light;

(iii) the two flag signal corresponding to the letters NC of the international code of signals;

(iv) the distant signal, consisting of a square flag having either above or below it a ball or anything resembling a ball;

(c) by sound signalling other than radiotelephony-

(i) the signal SOS ( ... --- ... );

(ii) a continuous sounding with any sound apparatus.

(2) The following signals, given either together or separately, before the sending of a message, signify that the commander of the aircraft wishes to give notice of difficulties but that he does not require immediate assistance-

(a) a succession of white pyrotechnic lights;

(b) the repeated switching on and off of the aircraft landing lights;

(c) the repeated switching on and off of its navigation lights,

in such a manner as to be clearly distinguished from the flashing navigation lights described in rule 12 of these Rules.

(3) The following signals, given either together or separately, indicate that the commander of the aircraft has an urgent message to transmit concerning the safety of the aircraft or of any person or property-

(a) by radiotelephony-

the spoken word "PAN";

(b) by visual signalling-

(i) the signal XXX (- .. -- .. -- .. -);

(ii) a succession of green pyrotechnic lights;

(iii) a succession of green flashes;

(c) by sound signalling other than radiotelephony the original XXX (- .. -- .. -- .. -).

(4) The following signals, given either together or separately, indicate that the commander of the aircraft has a message to transmit concerning the safety of navigation or giving meteorological warnings-

(a) by radiotelephony-

the spoken word "SECURITE";

(b) by visual or sound signalling other than radiotelephony - the signal TTT (---).

#### **47. Warning signals to aircraft in flight**

In Nigeria the following signals shall respectively have the following meanings-

- (a) (i) by day - a series of projectiles discharged at intervals of ten seconds,  
each showing on bursting black or white smoke; or
- (ii) by night - a series of projectiles discharged at intervals of ten seconds, each showing on bursting white lights or stars, or an intermittent white luminous beam directed at the aircraft,

indicates that the aircraft to which the signal is directed is in the vicinity of such an area as is referred to in paragraph (1) (c) of Regulations 57 of the Air Navigation Regulations and is required to change its course;

(b) by day or night, a series of projectiles discharged at intervals of ten seconds, each showing on bursting green lights or stars, indicates that the aircraft is required to land at the nearest aerodrome in accordance with the provisions of regulation 63 of the Air Navigation Regulations.

## PART IX

### *Ground lighting*

#### **48. Minimum ground lighting**

(1) The person in charge of an area to which this rule applies shall cause the lighting specified in rules 49 to 54 inclusive, of these Rules to be in operation whenever a flying machine or glider, flying for the purpose of the public transport of passengers, is taking off or landing at that area by night and during such period before or after the take-off or landing as may be necessary to ensure the safety of the aircraft:

Provided that, if the area is intended for use only by helicopters, there may be in operation in lieu of the lighting specified in rules 49, 50, 53 and 54 of these Rules, such other lighting as will enable the pilot of a helicopter in flight to-

- (a) identify the area;
- (b) determine the landing direction; and
- (c) make a safe approach and landing.

(2) The requirements of paragraph (1) of this Rule shall be deemed not to have been contravened if neither the person in charge of the area nor any person acting under his instructions knew or ought reasonably to have known that the aircraft was about to take off or land.

(3) This rule shall apply to any place, whether or not an aerodrome, intended to be used for the taking off, landing of aircraft or the manoeuvring of aircraft on the ground, but shall not apply to any Government aerodrome or to any aerodrome licensed for use by night.

#### **49. Approach lighting**

The lighting required by rule 48 of these Rules shall include lighting to give approach guidance to the runway or landing area intended to be used, which lighting shall consist of either-

(a) a line of identical lights each having an intensity of not less than 100 candles of red or white light in the direction of approach, equally spaced at intervals not exceeding 200 feet along the extended centre line of the runway for a distance of not less than 600 feet from the threshold in the direction of approach; or

(b) angle of approach lights so arranged as to indicate a sloping path between two and a half and four and a half feet above the horizontal which will provide, for any aircraft approaching to land, safe clearance above all obstacles within three nautical miles of the threshold of the runway and will give a warning by means of red beams of light if the aircraft is below the path; and the lights shall indicate the path throughout an angle in azimuth of not less than  $12^{\circ}$  symmetrically about a line parallel to the direction of landing:

Provided that if the lights specified in paragraph (1) (b) of rule 50 of these Rules are in operation, the lights specified in sub-paragraph (b) of this paragraph shall also be in operation, and not the lights specified in sub-paragraph (a) of this paragraph.

#### **50. Landing area lights**

(1) Where a runway is not provided, the lighting required by rule 48 of these Rules shall include either-

(a) two lines of white lights parallel to the direction of take-off or landing visible from all directions above the horizontal delineating the landing area intended for use by night, the lights in each line being equally spaced at intervals not exceeding 300 feet; and the lines of lights shall not be less than 100 feet nor more than 200 feet apart, and shall be so placed that a line drawn between a light and the opposite light in the parallel line of lights would be at right angles to the direction of use of the landing area; or

(b) white lights visible as aforesaid and arranged in the form of a T with the shaft of the T parallel to the direction of use and on the left edge of the area intended for landing when seen from the direction of approach and extending for the whole length of that edge, the lights in the shaft being equally spaced at intervals not exceeding 300 feet, and the cross arm of the T consisting of single lights placed 300 feet on either side of the light in the shaft of the T further from the approach end.

(2) Where a runway is provided, the lighting required by rule 48 of these Rules shall include two lines of white lights visible from the direction of approach, placed on the edge of the runway and each extending the whole of the length intended for use, the distance between successive lights in each line being not more than 300 feet so that, so far as is practicable a line drawn between a light and the opposite light in the parallel line of lights would be at right angles to the axis of the runway.

(3) The lights required by this rule shall have an intensity of not less than 50 candles.

#### **51. Guidance lights on the manoeuvring area and other parts of the aerodrome used by aircraft**

The lighting required by rule 48 of these Rules shall include either-

(a) the delineation of every taxiway intended for use by night by means of light along its edges, either blue lights on one side and yellow lights on the other or blue lights on both sides but the lights on each side shall have a brightness sufficient to give adequate guidance to a taxiing aircraft when the lights are spaced not more than 160 feet apart on straight stretches, and on curves the lights shall be at reduced spacing to mark the taxiway edge clearly and if the taxiway is unpaved the lines of lights shall be not less than fifty nor more than 100 feet apart; or

(b) when aircraft manoeuvring on the ground are not confined to taxiways, white lights visible from all directions above the horizontal and of an intensity of not less than 10 candles at 5° above the horizontal, spaced at intervals not exceeding 300 feet along the boundary of that part of the aerodrome provided for the use of aircraft and under the control of the person in charge of the aerodrome and intended for use by night.

#### **52. Areas unfit for use**

The lighting required by rule 48 of these Rules shall include red lights visible from all directions above the horizontal, sufficient to mark adequately any area unfit for the movement of aircraft at night.

#### **53. Landing direction indicator**

Where neither the lighting specified in paragraph (1) (a) of rule 49 of these Rules nor that specified in paragraph (1) (b) of rule 50 of these Rules is provided, the lighting required by rule 47 of these Rules shall include-

(a) adequate illumination of a landing T as specified in paragraph (2) of rule 40 of these Rules; or

(b) a landing T of the dimensions so specified, consisting of white lights, visible from all directions above the horizontal, of an intensity of not less than five nor more than twenty candles placed either in the signals area or between fifty and 100 feet to the left as seen from the direction of approach of the runway at the approach end thereof.

#### **54. Obstruction lights**

(1) The lighting required by rule 48 of these Rules shall include the lighting of all obstructions within the area in accordance with the provisions of this Rule.

(2) The lights on an obstruction shall be arranged so as to show not less than ten candles of red light in all directions in azimuth between 20° below and 60° above the horizontal.

(3) The lights shall be placed at the highest point of the obstruction except that, where the top of a chimney or other obstruction may be obscured by smoke, the lights may be placed instead not more than 10 feet below the top of the obstruction.



(4) If the height of an obstruction is more than 150 feet above ground level, lights shall be placed on the obstruction between the top and the ground at vertical intervals not exceeding 150 feet.

(5) On any obstruction of more than 150 feet in horizontal extent, lights as specified in paragraph (3) of this Rule shall be placed on the highest point of each length of 150 feet of the obstruction, measuring from one end of the obstruction.

(6) For the purposes of this rule any object, whether permanent or temporary, shall be deemed to be an obstruction if it is likely to endanger aircraft and if it is situated-

- (a) on that part of the manoeuvring area which is intended for use at night; or
- (b) within an area extending 200 feet on either side of the centre line of the area intended for landing or take-off at night; or
- (c) within 200 feet of the area so intended, if the height of the object is more than one quarter of the distance of the object from that area; or
- (d) within fifty feet of a lighted taxiway; or
- (e) within an area of the dimensions illustrated in this sub-paragraph, being an area at either end of a lighted runway or lighted landing area and if the height of the object, measured above the level of the nearer end of the runway or landing area is more than one thirtieth of the distance from the object to the nearest end of the runway or landing area:

Provided that a frangible object not more than three feet in height above the ground shall not be deemed to be an obstruction by reason of this sub-paragraph;

- (f) within one nautical mile of the centre of the area intended for use at night for the taking off, landing or manoeuvring of aircraft on the ground and more than 300 feet above the highest point of the ground within that area.

(7) Nothing in this rule shall be taken to require the lighting of-

- (a) any aircraft displaying navigation lights in accordance with Part III of these Rules;
- (b) in an area set aside for the parking of aircraft, any vehicle which is displaying the lights which are obligatory when it is being driven on a public highway;
- (c) any obstruction or part of an obstruction which, by reason of the lighting of other obstructions, is not likely to endanger aircraft in flight.

## PART X

### *Air traffic control*

#### **55. Provisions of air traffic control services**

(1) At every aerodrome (other than a Government aerodrome) which is provided with means of two-way radio communication with aircraft and is either situated in a control zone or is an aerodrome in respect of which the Minister has given a direction to the proprietor or person in charge of the aerodrome requiring air traffic control service to be provided there, the person in charge of the aerodrome shall cause air traffic control service to be provided at all times when the aerodrome is open for the take-off and landing of aircraft.

(2) At every aerodrome (other than a Government aerodrome) which is provided with means of two-way radio communication with aircraft and with equipment for providing holding aid, let-down aid, or approach aid by radio or radar, the person in charge of the aerodrome shall inform the Minister in advance of any period during which any of the said equipment will be in operation for the purpose of providing holding aid, let-down aid or approach aid and, without prejudice to paragraph (1) of this rule, cause air traffic control service to be provided at all times when the said equipment is notified as being in operation for any of those purposes.

#### **56. Licensing of air traffic controllers and student air traffic controllers**

(1) The Minister may grant a licence to any person to act as an air traffic controller, or as a student air traffic controller, upon his being satisfied that the applicant is a fit and proper person to hold the licence and is qualified by reason of his knowledge, experience, competence, skill and physical fitness so to act, and for that purpose the applicant shall furnish such evidence and undergo such examinations and tests (including in particular medical examinations) as the Minister may require of him:

Provided that the Minister shall not grant a licence to act as an air traffic controller to a person under the age of 21 years or a licence to act as a student air traffic controller to a person under the age of eighteen years.

(2) Every licence to act as an air traffic controller shall include a rating specifying the type of air traffic control service which the holder of the licence is competent to provide and the aerodromes at which he may provide that type of air traffic control service; and if throughout any period of ninety days the holder of the licence has not at any time provided at a particular aerodrome the type of air traffic control service specified in the rating, the rating shall cease to be valid in relation to that aerodrome at the end of that period, and upon a rating ceasing to be valid in relation to an aerodrome the holder of the licence shall forthwith inform the Minister in writing to that effect and shall forward the licence to the Minister to enable it to be endorsed accordingly.

(3) Every licence to act as a student air traffic controller shall be valid only for the purpose of authorising the holder to provide air traffic control service under the supervision of another person who is present at the time and is the holder of a valid air traffic controller's licence which includes a rating specifying the type of air traffic control service which is being provided by the student air traffic controller, and valid at the aerodrome in question.

(4) A licence as an air traffic controller or as a student air traffic controller shall not be valid unless the holder of the licence has signed his name thereon in ink with his ordinary signature.

(5) Subject to the provisions of regulation 54 of the Air Navigation Regulations, a licence as an air traffic controller or as a student air traffic controller shall remain in force for a period of twelve months and may be renewed by the Minister, from time to time, upon his being satisfied that the applicant is a fit and proper person and is qualified as aforesaid.

#### **57. Prohibition of unlicensed air traffic controllers and student air traffic controllers**

A person shall not provide any type of air traffic control service at any aerodrome at which air traffic control service is required to be provided by or under rule 55 of these Rules unless he does so under the direction of the Minister or is the holder of a valid air traffic controller's licence granted under rule 56 of these Rules authorising him to provide that type of service at that aerodrome, or is the holder of a student air traffic controller's licence and is supervised in accordance with paragraph (3) of that rule.

### PART XI

#### *Flight over an area in which search and rescue operations would be difficult*

#### **58. Flight over an area in which search and rescue operations would be difficult**

(1) The following provisions of this paragraph shall have effect in relation to public transport aircraft-

(a) before commencing a flight over an area notified for the purpose of this Rule as an area in which search and rescue operations would be difficult, the person in command of an aircraft shall submit or cause to be submitted to the appropriate air traffic control unit a flight notification containing such particulars as may be required by that air traffic control unit;

(b) when a flight notification has been submitted in accordance with sub-paragraph (a) of this paragraph, the person in command of an aircraft which is able to communicate by radio with an appropriate radio station shall, if he finds it necessary to deviate in respect of any particular from the said flight notification, report by radio the nature of the proposed deviation to the appropriate air traffic control unit as soon as practicable.

(2) Before commencing a flight over an area notified for the purpose of this rule as an area in which search and rescue operations would be difficult, a person in command of an aircraft, other than a public transport aircraft, may submit or cause to be submitted to the appropriate air traffic control unit a flight notification containing such particulars as may be required by that air traffic control unit; and if a flight notification is so submitted, the person in command of such aircraft shall comply with the requirements specified in paragraph (1) (b) of this rule as if the aircraft were a public transport aircraft.

---

## **CIVIL AVIATION (INVESTIGATION OF ACCIDENTS) REGULATIONS**

### ARRANGEMENT OF REGULATIONS

#### REGULATION

1. Short title.

*Interpretation and application of Regulations*

2. Interpretation.
3. Application of these Regulations.

*Notification of accidents*

4. Notification of accidents.
5. Particulars of accident to be notified.

*Access to and removal of damaged aircraft*

6. Access to and removal of damaged aircraft.

*Appointment and functions of Inspectors of Accidents*

7. Appointment and functions of Inspectors of Accidents.
8. Provisions relating to investigation by Inspectors of Accidents.
9. Report of investigation by Inspectors.

*Public inquiry*

10. Public inquiry.

*Rehearing of public inquiries*

11. Rehearing of public inquiry.

*General*

12. Accredited representatives of other states may investigate.
13. Penalties.
14. Savings.

---

**CIVIL AVIATION (INVESTIGATION OF ACCIDENTS) REGULATIONS**

[L.N. 14 of 1966.]

under section 2

[Commencement.]

[1st December, 1965]

## 1. Short title

These Regulations may be cited as the Civil Aviation (Investigation of Accidents) Regulations.

### *Interpretation and application of Regulations*

## 2. Interpretation

(1) In these Regulations, unless the context otherwise requires-

(a) "**accident**" includes any fortuitous or unexpected event by which the safety of an aircraft or any person is threatened;

[Cap. C13.]

(b) "**Act**" means the Civil Aviation Act, and includes any regulations made or having effect as if made under the Act;

(c) "**aircraft**" includes all balloons (whether captive or free), gliders, airships, and flying machines;

(d) "**Minister**" means the Minister charged with responsibility for matters relating to civil aviation;

(e) "**references to Nigeria**" include references to the territorial waters adjacent thereto;

(f) "**owner**" means, where an aircraft is registered, the registered owner;

(g) "**substantial damage**" includes any damage which necessitates the replacement or extensive repair of any major component.

(2) The Interpretation Act shall apply for the purpose of the interpretation of these Regulations.

[Cap.123.]

## 3. Application of these Regulations

These Regulations relate to civil aviation only and shall apply to accidents arising out of or in the course of air navigation which occur to any civil aircraft in or over Nigeria, or elsewhere to civil aircraft registered in Nigeria.

### *Notification of accidents*

## 4. Notification of accidents

An accident shall be notified in accordance with the provisions of regulation 5 of these Regulations if, between the time when any person boards an aircraft with the intention of flight and such time as all persons have disembarked therefrom-

(a) any person suffers death or serious injury while in or upon the aircraft or by direct contact with the aircraft or anything attached thereto; or

(b) the aircraft receives substantial damage.

#### **5. Particulars of accident to be notified**

(1) Where an accident occurs of which notification is required to be given under regulation 4 of these Regulations, the person in command of the aircraft involved at the time of the accident, or if he be killed or incapacitated, then the owner, operator, hirer or other person on whose behalf he was in command of the aircraft, as the case may be, shall forthwith send notice thereof to the Minister by the quickest means of communications available and in the case of an accident occurring in or over Nigeria shall also notify forthwith the nearest police authorities of the accident and of the place where it occurred.

(2) The notice to the Minister referred to in paragraph (1) of this regulation shall state as far as possible-

(a) the type and the nationality and registration marks of the aircraft;

(b) the name of the owner, operator and hirer, if any, of the aircraft;

(c) the name of the person in command of the aircraft;

(d) the date and Greenwich mean time of the accident;

(e) the last point of departure and the next point of intended landing of the aircraft;

(f) the position of the aircraft with reference to some easily defined geographical point;

(g) the number of persons (if any)-

(i) killed;

(ii) seriously injured,

as a result of the accident;

(h) the nature of the accident as far as it is known;

(i) brief particulars of damage to the aircraft.

(3) Where an accident to which these Regulations apply occurs, whether in or over Nigeria or elsewhere, the owner, operator or hirer of the aircraft shall, if so required by notice in writing from the Minister, send to the Minister within such time as may be specified in the notice, such information with respect thereto in such form as the Minister may require.

#### *Access to and removal of damaged aircraft*

#### **6. Access to and removal of damaged aircraft**

(1) Where an accident occurs in or over Nigeria of which notification is required to be given under regulation 4 of these Regulations, no person other than an authorised person shall have access to the aircraft involved in the accident and the aircraft shall not, except under the authority of the Minister, be removed or otherwise interfered with:

Provided that-

(i) the aircraft may be removed or interfered with so far as may be necessary for the purpose of extricating persons or animals involved, removing any mail carried by the aircraft, preventing destruction by fire or other cause, or preventing any danger or obstruction to the public or to air navigation or to other transport;

(ii) goods or passengers' baggage may be removed from the aircraft under the supervision of a police officer, but, if the aircraft has come from a place outside Nigeria, it shall not be removed from the vicinity of the aircraft except on clearance by or with the consent of an officer of the Nigeria Customs Service;

(iii) if an aircraft is wrecked on the water, the aircraft or any contents thereof may be removed to such extent as may be necessary for bringing it or them to a place of safety.

(2) In this regulation, the expression "**authorised person**" means any person authorised by the Minister either generally or specially to have access to any aircraft involved in an accident and includes any police officer or any officer of the Nigeria Customs Service.

#### *Appointment and functions of Inspectors of Accidents*

### **7. Appointment and functions of Inspectors of Accidents**

(1) For the purpose of carrying out investigation into the causes and circumstances of accidents to which these Regulations apply, the Minister shall appoint persons as Inspectors of Accidents, one of whom shall be appointed by him as the Chief Inspector of Accidents.

(2) The Chief Inspector of Accidents, if he thinks fit, may himself carry out an investigation or cause an investigation to be carried out by an Inspector of Accidents of any accident to which these Regulations apply, whether or not such accident is one whereof notification is required to be given under regulation 4 of these Regulations.

(3) Public notice that such investigation is taking place shall be given in such manner as the Minister may think fit and shall state that any person who may desire to make representation concerning the circumstances or causes of the accident may do so in writing within a time to be specified in the notice.

### **8. Provisions relating to investigation by Inspector of Accidents**

(1) With respect to any Inspector's investigation, the following provisions of this regulation shall have effect.

(2) The Inspector of Accidents by whom the investigation is made (in this regulation referred to as "the Inspector") shall have power-

(a) by summons under his hand to call before him and examine all such persons as he thinks fit, to require such persons to answer any questions or furnish any information or produce any books, paper, documents and articles which the Inspector may consider relevant, and to retain any such books, papers, documents and articles until the completion of the investigation;

(b) to take statements from all such persons as he thinks fit and to require any such person to make and sign a declaration of the truth of the statement made by him;

(c) to have access to and examine any aircraft involved in the accident and the place where the accident occurred, and for that purpose to require any such aircraft or any part or equipment thereof to be preserved unaltered pending examination;

(d) to examine, remove, test, take measures for the preservation of, or otherwise deal with the aircraft or any part thereof or anything contained therein;

(e) to enter and inspect any place or building the entry or inspection whereof appears to the Inspector to be requisite for the purposes of the investigation;

(f) to take measures for the preservation of evidence.

(3) Where an accident has occurred in or over Nigeria, to an aircraft registered in any country other than Nigeria, the Minister may authorise an investigator appointed by the duly competent authority of that other country to carry out an investigation, and in that event the Minister shall so far as he is able, facilitate inquiries by the investigator so appointed.

(4) The investigation shall be held in private.

(5) Where it appears to the Inspector that in order to resolve any conflict of evidence or that for any other reason it is expedient so to do, he may permit any person to appear before him and call evidence and examine witnesses.

(6) Where it appears to the Inspector that any degree of responsibility for the accident may be attributable to any person, and if it appears to the Inspector to be practicable so to do that person or, if he be deceased, his legal personal representatives, shall be given notice that blame may be attributed to him and be permitted to make a statement or give evidence and to produce witnesses and to examine any witnesses from whose evidence it appears that he may be blameworthy.

(7) The Attorney-General of the Federation may intervene at any stage of an investigation in order to make representations or to examine witnesses, if it appears to him expedient so to do in the public interest.

(8) Every person summoned by the Inspector as a witness in accordance with this regulation shall be allowed such expenses as the Minister may from time to time determine.



## **9. Report of investigation by Inspectors**

(1) Upon the completion of an investigation, the Chief Inspector of Accidents, or such other Inspector as may be authorised by the Minister, shall make a report to the Minister.

(2) The Chief Inspector of Accidents shall state the circumstances of the case and his conclusions as to the cause of the accident, adding any observations and recommendations which he thinks fit to make with a view to the preservation of life and the avoidance of similar accidents in future and to what extent effect has been given to the provisions of paragraph (6) of regulation 8 of these Regulations.

(3) The Minister may cause the whole or any part of such report to be made public in such manner as he thinks fit.

### *Public inquiry*

## **10. Public inquiry**

(1) Where it appears to the Minister that it is expedient to hold a public inquiry into the causes and circumstances of an accident to which these Regulations apply, he may direct that a public inquiry be held by a Commissioner appointed by the Chief Justice of Nigeria; and in any such case any Inspector's investigation relating to the accident shall be discontinued.

(2) The Commissioner (in these Regulations referred to as "the court") shall be a barrister of not less than ten years' standing, and the court shall be assisted by not less than two assessors possessing aeronautical, engineering or other special skill or knowledge, one of whom may be the Chief Inspector of Accidents, or one of the Inspectors of Accidents.

The assessors shall be appointed by the Chief Justice of Nigeria.

(3) Where the Minister has directed a public inquiry to be held, he shall remit the case to the Attorney-General of the Federation; and thereafter the preparation and presentation of the case shall be conducted by the Solicitor-General of the Federation under the direction of the Attorney-General of the Federation; the Chief Inspector of Accidents shall render such assistance to the court and to the Attorney-General of the Federation as is in his power and for that purpose shall have the powers conferred by paragraph (2) of regulation 8 on an Inspector of Accidents with respect to an Inspector's investigation.

(4) Every public inquiry held under these Regulations shall be conducted in such manner that, if a charge is made against any person, that person shall have an opportunity of making a defence.

(5) When a public inquiry has been ordered, the Attorney-General of the Federation may cause a notice, to be called a notice of inquiry, to be served upon the owner, operator, hirer and person in command of any aircraft involved in the accident, as well as upon any person who in his opinion ought to be served with such notice and the notice shall contain a statement of the questions which on the information then in the possession of the Attorney-General of the Federation he intends to raise on the hearing of

the inquiry, and the Attorney-General of the Federation may, at any time before the hearing of the inquiry, by a subsequent notice amend, add to, or omit any of the questions specified in the notice of inquiry.

(6) The Attorney-General of the Federation, the owner, the operator, the hirer, the person in command and any other person upon whom a notice of inquiry has been served, shall be deemed to be parties to the proceedings.

(7) Any other person, including the Minister, may, by leave of the Court appear, and any person who so appears shall thereupon become a party to the proceedings.

(8) The court shall have, for the purposes of the inquiry, all the powers of a court of summary jurisdiction when acting as a court in the exercise of its ordinary jurisdiction, and without prejudice to those powers, the court may-

(a) enter and inspect, or authorise any person to enter and inspect, any place or building entry or inspection whereof appears to the court requisite for the purposes of the inquiry;

(b) by summons require the attendance as witnesses of all such persons as the court thinks fit to call and examine, and require such persons to answer any questions or furnish any information or produce any books, papers, documents and articles which the court may consider relevant;

(c) administer the oath to any such witness, or require any witness to make and sign a declaration of the truth of the statements made by him in his examination.

(9) The assessors shall have the same power of entry and inspection as the court.

(10) Affidavits and statutory declarations may, by permission of the court and saving all just exceptions, be used as evidence at the hearing.

(11) At any time and place appointed for holding the inquiry, the court may proceed with the inquiry whether the parties, upon whom a notice of inquiry has been served, or any of them, are present or not.

(12) The court shall hold the inquiry in open court save to the extent to which the court is of opinion that in the interest of justice or in the public interest any part of the evidence, or any argument relating thereto, should be heard in camera.

(13) The proceedings on the inquiry shall commence with the production and examination of witnesses on behalf of the Attorney-General of the Federation. These witnesses, after being examined on behalf of the Attorney-General of the Federation, may be cross-examined by the parties in such order as the court may direct, and may then be re-examined on behalf of the Attorney-General of the Federation. Questions asked and documents tendered as evidence in the course of the examination of these witnesses shall not be open to objection merely on the ground that they do or may raise questions which are not contained in or which vary from the question specified in the notice of inquiry or subsequent notices referred to in paragraph (5) of this regulation.

(14) When the examination of the witnesses produced on behalf of the Attorney-General of the Federation has been concluded, the Attorney-General of the Federation shall state the questions in reference to the accident and the conduct of persons connected with the accident upon which the opinion of the court is desired. In framing the questions for the opinion of the court, the Attorney-General of the Federation shall make such modifications in, additions to or omissions from the questions in the notice of inquiry or subsequent notices referred to in paragraph (5) of this regulation, as, having regard to the evidence which has been given, the Attorney-General of the Federation or the court may think fit.

(15) After the questions for the opinion of the court have been stated, the court shall proceed to hear the parties to the proceedings upon and determine the questions so stated. Each party to the proceedings shall be entitled to address the court and produce witnesses or recall any of the witnesses who have already been examined for further examination and generally adduce evidence and the parties shall be heard and their witnesses examined, cross-examined and re-examined in such order as the court shall direct. Further witnesses may also be produced and examined on behalf of the Attorney-General and may be cross-examined by the parties and re-examined on behalf of the Attorney-General of the Federation.

(16) When the whole of the evidence in relation to the questions for the opinion of the court has been concluded, any of the parties who desires so to do may address the court upon the evidence and the court may be addressed in reply upon the whole case on behalf of the Attorney-General of the Federation.

(17) The court may adjourn the inquiry, from time to time, and from place to place; and where an adjournment is asked for by any party to the inquiry, the court may impose such terms as to payment of costs or otherwise as it may think just as a condition of granting the adjournment.

(18) The court shall make a report to the Minister stating fully the circumstances of the case and the opinion of the court touching the causes of the accident and adding any observations and recommendations which the court thinks fit to make with a view to the preservation of life and the avoidance of similar accidents in future, including a recommendation for the cancellation, suspension or endorsement of any licence, certificate or other document.

(19) Each assessor shall either sign the report with or without reservations or state in writing his dissent therefrom and his reasons for such dissent, and such reservations or dissent and reasons (if any) shall be forwarded to the Minister with the report and the Minister shall, unless there are good reasons to the contrary, cause any such report and reservations or dissent and reasons (if any) to be made public wholly or in part in such a manner as he thinks fit.

(20) Every person attending as a witness before the court shall be allowed such expenses as would be allowed to witness attending before a court of record, and in case of dispute as to the amount to be allowed, the same shall be referred by the court to a Judge of the Supreme Court who on request signed by the court shall ascertain and certify the proper amount of the expenses:

Provided that, in the case of any party to the proceeding or of any person in the employment of such a party, any such expenses may be disallowed if the court in its discretion so directs.

(21) The court may order the costs and expenses of the inquiry, or any part thereof, to be paid by any party, if it finds that the accident was due to the act or default or negligence of that party or of any person in the employment of that party and any such order shall, on the application of any person entitled to the benefit thereof, be enforced by a court of summary jurisdiction as if the costs and expenses were a penalty imposed by that court, but subject to any such order, such costs and expenses shall be deemed to be part of the expenses of the Minister in the exercise of his powers under the Act.

(22) Any notice, summons or other document issued under this regulation may be served by sending the same by registered post to the last known address of the person to be served.

(23) The service of any notice, summons or other document may be proved by the oath or affidavit of the person by whom it was served.

#### *Rehearing of public inquiries*

### **11. Rehearing of public inquiries**

(1) The Minister may, in any case where a public inquiry has been held, direct a rehearing of the inquiry, either generally or as to any part thereof, and shall do so if-

(a) new and important evidence which could not be produced at the inquiry has been discovered; or

(b) for any other reasons there is in his opinion ground for suspecting that a miscarriage of justice has occurred.

(2) If the Minister directs any inquiry to be reheard, the Chief Justice of Nigeria may order that the inquiry shall be reheard either by the court by whom the inquiry was heard in the first instance or by some other person appointed by him to hold the rehearing.

(3) Any rehearing shall be subject to and conducted in accordance with the provisions of these Regulations relating to the holding of public inquiries.

#### *General*

### **12. Accredited representatives of other states may investigate**

Where an Inspector's investigation or a public inquiry relates to an accident which has occurred in or over Nigeria to an aircraft registered in any country other than Nigeria, an accredited representative of the country in which the aircraft is registered, or of any country which has, on request, furnished information in connection with the accident, may take part in the investigation or in the inquiry as the case may be; he may be accompanied by such technical and other advisers as may be considered necessary by the authorities of the country by which he is appointed.

### **13. Penalties**

Any person who-

(a) wilfully obstructs or impedes the Court or an Inspector of Accidents or an assessor or any person acting under the authority of the Minister in the exercise of any powers or duties under these Regulations; or

(b) without reasonable excuse (proof whereof shall lie on him) fails after having the expenses (if any) to which he is entitled tendered to him, to comply with any summons or requisition of the court holding a public inquiry or an Inspector of Accidents holding an Inspector's investigation under these Regulations; or

(c) without reasonable excuse (proof whereof shall lie on him) fails to comply with any of the provisions of regulations 4, 5 and 6 of these Regulations,

shall be guilty of an offence and liable on conviction to a fine not exceeding one hundred naira or to imprisonment for a term not exceeding three months:

Provided that every witness shall, in respect of any evidence written by him for or given by him before an Inspector of Accidents, be entitled to the same privileges to which he would have been entitled if giving evidence before a court of justice.

#### **14. Savings**

(1) Nothing in these Regulations shall limit the powers of any authority under the Merchant Shipping Act.

[Cap. M 11.]

(2) Nothing in these Regulations shall limit the power of the Minister under the Act of cancelling, suspending or endorsing any licence, certificate or other document.

---

## **CIVIL AVIATION (AIR NAVIGATION) REGULATIONS**

### **ARRANGEMENT OF REGULATIONS**

#### **PART I**

#### *Registration and marking of aircraft*

#### **REGULATION**

1. Aircraft to be registered.
2. Registration of aircraft in Nigeria.
3. Nationality and registration marks.

#### **PART II**

*Airworthiness and equipment of aircraft*

4. Certificate of airworthiness to be in force.
5. Issue, renewal and validation of certificates of airworthiness.
6. Certificate of maintenance.
7. Inspection, overhaul, repair, replacement and modification.
8. Licensing of aircraft maintenance engineers.
9. Equipment of aircraft.
10. Radio equipment of aircraft.
11. Aircraft, engine and propeller log books to be kept.
12. Aircraft weight schedule.
13. Access and inspection for airworthiness purposes.

PART III

*Aircraft crew and licensing*

14. Composition of crew of aircraft.
15. Members of flight crew shall hold licences.
16. Grant and renewal of licences to members of flight crew.
17. Validation of licences granted outside Nigeria.
18. Personal flying log book.
19. Instruction in flying.
20. Minimum age of a glider pilot.

PART IV

*Operation of aircraft*

21. Operations manual.
22. Responsibilities of a public transport operator.
23. Loading of public transport aircraft.
24. Operating conditions for public transport aircraft.
25. Weather conditions for aircraft not registered in Nigeria.
26. Pre-flight action by commander of aircraft.
27. Pilots to remain at controls.
28. Duties of commander of aircraft for transporting passengers.
29. Operation of radio in aircraft.
30. Towing of gliders.
31. Towing, picking up and raising of persons and articles.
32. Dropping of persons and articles.
33. Carriage of munitions of war prohibited.
34. Carriage of dangerous goods.
35. Method of carriage of persons.
36. Exits and break-in markings.
37. Imperilling safety of aircraft.
38. Imperilling safety of any person or property.
39. Drunkenness in aircraft.
40. Smoking in aircraft.
41. Authority of commander of aircraft.
42. Stowaways.

PART V

*Fatigue of flight crew*

- 43. Application, interpretation and modification of Part V.
- 44. Duties of operators to prevent excessive fatigue of flight crew.
- 45. Limits on flying time, duty periods, and rest periods.
- 46. Maximum flying duty periods for pilots and flight engineers.
- 47. Minimum rest periods for flight crew.
- 48. Records of flight times, duty periods and rest periods.
- 49. Maximum flight times for flight crew.
- 50. Provision for particular cases.

PART VI

*Documents*

- 51. Documents to be carried.
- 52. Production of documents.
- 53. Preservation of documents, etc.
- 54. Revocation, suspension and variation of certificates, etc.
- 55. Offences in relation to documents.

PART VII

*Control of air traffic*

- 56. Rules of the Air and Air Traffic Control.
- 57. Power to prohibit or restrict flying.
- 58. Balloons, kites and airships.

PART VIII

*Air routes and airways, aerodromes, lights and other facilities*

- 59. Designation of air routes and airways.
- 60. Use of Government airports.
- 61. Licensing of airports.
- 62. Places authorised as aerodromes.
- 63. Use of aerodromes.
- 64. Power to give directions.
- 65. Rights of Government aircraft.
- 66. Customs airports.
- 67. Use of aerodromes by Contracting States.
- 68. Noise and vibration on aerodromes.
- 69. Trading within Government aerodromes.
- 70. Authority to trade.
- 71. Aeronautical lights and other facilities.
- 72. Dangerous lights.

PART IX

*General*

- 73. Prohibited areas.
- 74. Power to prevent aircraft flying.
- 75. Right of access to aerodromes and other places.
- 76. Obstruction of persons.
- 77. Enforcement of directions.
- 78. Fees.
- 79. Penalties.
- 80. Extra-territorial effect of the Regulations.
- 81. Power to make Regulations.
- 82. Application of Regulations.
- 83. Exemption.
- 84. Interpretation.
- 85. Saving.
- 86. Small aircraft.
- 87. Short title.

---

SCHEDULES

FIRST SCHEDULE

PART A

*Table of general classification of air craft*

PART B

*Nationality and registration marks of aircraft registered in Nigeria*

SECOND SCHEDULE

*A and B Conditions*

THIRD SCHEDULE

*Categories of aircraft*

FOURTH SCHEDULE

*Maintenance engineers: privileges of licences*

FIFTH SCHEDULE

*Aircraft equipment*

SIXTH SCHEDULE



*Radio apparatus to be carried in aircraft*

SEVENTH SCHEDULE

*Aircraft, engine and propeller log books*

EIGHTH SCHEDULE

*Areas specified in connection with the carriage of flight navigators as members of the*

*flight crew of public transport aircraft*

NINTH SCHEDULE

*Flight crew of aircraft: licences and ratings*

TENTH SCHEDULE

*Public transport - operational requirements*

ELEVENTH SCHEDULE

*Documents to be carried by aircraft*

TWELFTH SCHEDULE

*Weather minima*

THIRTEENTH SCHEDULE

*Customs airports*

FOURTEENTH SCHEDULE

*Aerodrome permit*

FIFTEENTH SCHEDULE

*Penalties*

---

**CIVIL AVIATION (AIR NAVIGATION) REGULATIONS**

[L.N. 15 of 1966.]

under section 1

[Commencement.]

[1st December, 1965]

PART I

*Registration and marking of aircraft*

**1. Aircraft to be registered**

(1) Subject to the provisions of paragraph (2) of this regulation, an aircraft shall not fly over Nigeria unless it is registered in-

- (a) Nigeria; or
- (b) a Contracting State; or
- (c) some other country in relation to which there is in force an agreement between the government of the Federation of Nigeria and the government of that country which makes provision for the flight over Nigeria of aircraft registered in that country.

(2) Notwithstanding paragraph (1) of this regulation-

- (a) a glider may fly unregistered and shall be deemed to be registered in Nigeria for the purpose of regulations 9, 10, 15 and 26 of these Regulations on any flight which-
  - (i) begins and ends in Nigeria without passing over any other country; and
  - (ii) is not for the purpose of public transport or aerial work;
- (b) any aircraft may fly unregistered on any flight which-
  - (i) begins and ends in Nigeria without passing over any other country; and
  - (ii) is in accordance with the "B Conditions" set forth in the Second Schedule to these Regulations;

[Second Schedule.]

(c) that paragraph shall not apply to any kite or captive balloon.

(3) The Minister may, in such special circumstances and subject to such conditions or limitations as he may think fit, temporarily exempt from the provisions of paragraph (1) of this regulation an aircraft registered elsewhere.

(4) If an aircraft flies over Nigeria in contravention of paragraph (1) of this regulation in such manner or circumstances that if the aircraft had been registered in Nigeria an offence against these Regulations would have been committed, the like offence shall be deemed to have been committed in respect of that aircraft.

*Registration of aircraft in Nigeria*

**2. Registration of aircraft in Nigeria**

(1) The Minister shall be the authority for the registration of aircraft in Nigeria.

(2) Subject to the provisions of this regulation, an aircraft shall not be registered or continue to be registered in Nigeria if it appears to the Minister that-

- (a) the aircraft is registered anywhere outside Nigeria; or
- (b) an unqualified person is entitled as owner to any legal or beneficial interest in the aircraft or any share therein; or
- (c) it would be inexpedient in the public interest for the aircraft to be or to continue to be registered in Nigeria.

(3) The following persons, and no others, shall be qualified to be the owner of a legal or beneficial interest in an aircraft registered in Nigeria or a share therein-

- (a) citizens of Nigeria;
- (b) bodies corporate established under and subject to the laws of Nigeria.

(4) If an unqualified person residing or having a place of business in Nigeria is entitled as owner to a legal or beneficial interest in an aircraft, or a share therein, the Minister, upon being satisfied that the aircraft may otherwise be properly so registered, may register the aircraft in Nigeria; but the person aforesaid shall not cause or permit the aircraft, while it is registered in pursuance of this paragraph, to be used for the purpose of public transport or aerial work.

(5) If an aircraft is chartered by demise to a person qualified as aforesaid the Minister may, whether or not an unqualified person is entitled as owner to a legal or beneficial interest therein, register the aircraft in Nigeria in the name of the charterer upon being satisfied that the aircraft may otherwise be properly so registered, and subject to the provisions of this regulation, the aircraft may remain so registered during the continuation of the charter.

(6) An application for the registration of an aircraft in Nigeria shall be made in writing to the Minister, and shall include or be accompanied by such particulars and evidence relating to the aircraft and the ownership and chartering thereof as he may require to enable him to determine whether the aircraft may properly be registered in Nigeria and to issue the certificate referred to in paragraph (8) of this regulation, and in particular, the application shall include the proper description of the aircraft according to column 4 of the "General Classification of Aircraft" set forth in Part A of the First Schedule to these Regulations.

[First Schedule.]

(7) Upon receiving an application for the registration of an aircraft in Nigeria and being satisfied that the aircraft may properly be so registered, the Minister shall register the aircraft, wherever it may be, and shall include in the register the following particulars-

- (a) the number of the certificate;
- (b) the nationality mark of the aircraft, and the registration mark assigned to it by the Minister;
- (c) the name of the constructor of the aircraft and its designation;
- (d) the serial number of the aircraft;
- (e) the name and address of every person who is entitled as owner to a legal interest in the aircraft or a share therein, or in the case of an aircraft which is the subject of a hire-purchase agreement, the name and address of the hirer; or
- (f) in the case of an aircraft registered in pursuance of paragraph (4) or (5) of this regulation, an indication that it is so registered.

(8) The Minister shall furnish to the person or persons in whose name the aircraft is registered (in this regulation referred to as "the registered owner") a certificate of registration, which shall include the foregoing particulars and the date on which the certificate was issued.

(9) Subject to paragraphs (4) and (5) of this regulation, if at any time after an aircraft has been registered in Nigeria an unqualified person becomes entitled as owner to a legal or beneficial interest in the aircraft or a share therein, the registration of the aircraft shall thereupon become void and the certificate of registration shall forthwith be returned by the registered owner to the Minister for cancellation.

(10) Any person who is registered as the owner of an aircraft registered in Nigeria shall forthwith inform the Minister in writing of-

- (a) any change in the particulars which were furnished to the Minister upon application being made for the registration of the aircraft;
- (b) the destruction of the aircraft, or its permanent withdrawal from use;
- (c) in the case of an aircraft registered in pursuance of paragraph (5) of this regulation, the termination of the demise charter.

(11) Any person who becomes the owner of an aircraft registered in Nigeria shall forthwith inform the Minister in writing to that effect.

(12) The Minister may, whenever it appears to him necessary or appropriate to do so for giving effect to this Part of these Regulations or for bringing up to date or otherwise correcting the particulars entered on the register, amend the register, or if he thinks fit, may cancel the registration of the aircraft, and shall cancel that registration if he is satisfied that there has been a change in the ownership of the aircraft.

(13) The Minister may, by regulations, adapt or modify the foregoing provisions of this regulation as he deems necessary or expedient for the purpose of providing for the temporary transfer of aircraft to or from the Nigerian register, either generally or in relation to a particular case or class of cases.

(14) In these Regulations, references to an interest in an aircraft do not include references to an interest in an aircraft to which a person is entitled only by virtue of his membership of a flying club and the reference in paragraph (10) of this regulation to the registered owner of an aircraft includes in the case of a deceased person, his legal personal representative, and in the case of a body corporate which has been dissolved, its successor.

(15) Nothing in this regulation shall require the Minister to cancel the registration of an aircraft if in his opinion it would be inexpedient in the public interest to do so.

### *Nationality and registration marks*

#### **3. Nationality and registration marks**

(1) An aircraft (other than an aircraft permitted by or under these Regulations to fly without being registered) shall not fly unless it bears painted thereon or affixed thereto, in the manner required by the law of the country in which it is registered, the nationality and registration marks required by that law.

(2) The marks to be borne by aircraft registered in Nigeria shall comply with Part B of the First Schedule to these Regulations.

[First schedule. Part B.]

(3) An aircraft shall not bear any marks which purport to indicate-

(a) that the aircraft is registered in a country in which it is not in fact registered; or

(b) that the aircraft is a state aircraft of a particular country if it is not in fact such an aircraft, unless the appropriate authority of that country has sanctioned the bearing of such marks.

## PART II

### *Airworthiness and equipment of aircraft*

#### **4. Certificate of airworthiness to be in force**

(1) An aircraft shall not fly unless there is in force in respect thereof, a certificate of airworthiness duly issued or rendered valid under the law of the country in which the aircraft is registered, and any conditions subject to which the certificate was issued or rendered valid are complied with:

Provided that the foregoing prohibition shall not apply to flights, beginning and ending in Nigeria without passing over any other country, of-

(a) a glider, if it is not being used for the public transport of passengers or aerial work;

- (b) a balloon, if it is not being used for the public transport of passengers;
- (c) a kite;
- (d) an aircraft flying in accordance with the "A Conditions" or "B Conditions" set forth in the Second Schedule to these Regulations;
- (e) an aircraft flying in accordance with the conditions of a permit to fly issued by the Minister in respect of that aircraft.

(2) In the case of an aircraft registered in Nigeria, the certificate of airworthiness referred to in paragraph (1) of this regulation shall be a certificate issued or rendered valid in accordance with the provisions of regulation 5 of these Regulations.

#### **5. Issue, renewal and validation of certificates of airworthiness**

(1) The Minister may issue, in respect of any aircraft, a certificate of airworthiness if he is satisfied that the aircraft is fit to fly having regard to-

- (a) the design, construction, workmanship and materials of the aircraft (including in particular any engines fitted therein), and of any equipment carried in the aircraft which he considers necessary for the airworthiness of the aircraft; and
- (b) the results of flying trials, and such other tests of the aircraft as he may require:

Provided that if the Minister has issued a certificate of airworthiness in respect of an aircraft which, in his opinion, is a prototype aircraft or a modification of a prototype aircraft, he may dispense with flying trials in the case of any other aircraft if he is satisfied that it conforms to such prototype or modification.

(2) Every certificate of airworthiness shall specify such categories as are, in the opinion of the Minister, appropriate to the aircraft in accordance with the Third Schedule to these Regulations and the certificate shall be issued subject to the condition that the aircraft shall be flown only for the purposes indicated in the said Schedule in relation to those categories.

[Third Schedule.]

(3) The Minister may issue the certificate of airworthiness subject to such other conditions relating to the airworthiness of the aircraft as he thinks fit.

(4) The certificate of airworthiness may designate the performance group to which the aircraft belongs for the purposes of the requirements referred to in paragraph (1) of regulation 24 of these Regulations.

(5) The Minister may, subject to such conditions as he thinks fit, issue a certificate of validation rendering valid for the purposes of these Regulations a certificate of airworthiness issued in respect of any aircraft under the law of any country other than Nigeria.

(6) Subject to the provisions of this regulation and of regulation 54 of these Regulations, a certificate of airworthiness or validation issued under this regulation shall remain in force for such period as may be specified therein, and may be renewed from time to time by the Minister for such further period as he thinks fit.

(7) A certificate of airworthiness or a certificate for validation issued in respect of an aircraft shall cease to be in force-

(a) if the aircraft, or such of its equipment as is necessary for the airworthiness of the aircraft, is overhauled, repaired or modified, or if any part of the aircraft or of such equipment is removed or is replaced, otherwise than in a manner and with material of a type approved by the Minister either generally or in relation to a class of aircraft or to the particular aircraft; or

(b) until the completion of any inspection of the aircraft or of any of such equipment as aforesaid, being an inspection required by the Minister to be made for the purpose of ascertaining whether the aircraft remains airworthy.

(8) Without prejudice to any other provision of these Regulations, the Minister may, for the purposes of the regulation, accept reports furnished to him by a person whom he may approve either absolutely or subject to such conditions as he thinks fit as qualified to furnish such reports.

(9) The Minister shall cause to be prepared and preserved in relation to each aircraft registered in Nigeria, a record enabling the aircraft (including in particular its engines) and such of its equipment as he may have considered necessary for the airworthiness of the aircraft in issuing, varying or rendering valid a certificate of airworthiness to be identified with the drawings and other documents on the basis of which the certificate was issued, varied or rendered valid, as the case may be.

(10) All equipment so identified shall for the purposes of these Regulations be deemed to be equipment necessary for the airworthiness of the aircraft.

(11) The Minister shall cause such record to be produced for examination upon request being made therefore at any reasonable time by any person having, in the opinion of the Minister, reasonable grounds for requiring to examine it.

## **6. Certificate of maintenance**

(1) An aircraft registered in Nigeria shall not fly for the purpose of public transport or dropping or projecting any material for agricultural, public health or similar purposes unless-

(a) the aircraft (including in particular its engines), together with its equipment and radio station, is maintained in accordance with maintenance schedules approved by the Minister in relation to that aircraft;

(b) there are in force in respect of that aircraft certificates (in these Regulations referred to as "certificates of maintenance") issued in accordance with the provisions of this regulation and certifying that maintenance has been carried out in accordance with such maintenance schedules:

Provided that an aircraft may, notwithstanding that sub-paragraphs (a) and (b) of this regulation have not been complied with in relation to the radio station therein, fly for the sole purpose of enabling persons to be trained to perform duties in aircraft.

(2) Every certificate of maintenance shall come into force upon being issued and shall cease to be in force upon the expiration of the period of its validity in elapsed time or flying time, whichever may be the earlier, as specified in the relevant maintenance schedule and the period of validity of the certificate shall be recorded in the certificate at the time when it is issued.

(3) A certificate of maintenance may be issued for the purposes of this regulation only by-

(a) the holder of a licence granted under these Regulations as an aircraft maintenance engineer or aircraft radio maintenance engineer being a licence of a category appropriate in accordance with regulation 8 of these Regulations and the Fourth Schedule to these Regulations; or

[Fourth Schedule.]

(b) the holder of a licence as such an engineer granted under the law of a country other than Nigeria and rendered valid under these Regulations, in accordance with the privileges endorsed on the licence; or

(c) a person whom the Minister has authorised to issue a certificate of maintenance in a particular case, and in accordance with that authority:

Provided that, upon approving a maintenance schedule, the Minister may direct that certificates of maintenance relating to that schedule, or to any part thereof specified in his direction, may be issued only by the holder of such a licence as is so specified.

(4) Certificates of maintenance shall be issued in duplicate. One of the duplicates shall, during the period of validity of the certificate, be carried in the aircraft when regulation 51 of these Regulations so requires, and the other shall be kept by the operator elsewhere than on the aircraft.

(5) On the termination of every flight by an aircraft registered in Nigeria for any of the purposes specified in paragraph (1) of this regulation, the commander of the aircraft shall enter in a technical log-

(a) the times at which the flight began and ended; and

(b) particulars of any defect in any part of the aircraft or its equipment which is known to him, being a part to which a maintenance schedule relates, or, if no such defect is known to him, an entry to that effect; and shall sign and date such entries:



Provided that in the case of a number of consecutive flights beginning and ending on the same day and with the same person as commander of the aircraft, the commander of an aircraft-

(i) flying for the purpose of public transport where each of the aforesaid consecutive flights begins at the same aerodrome and ends at that aerodrome; or

(ii) flying for the purpose of dropping or projecting any material for agricultural, public health or similar purposes,

may, except where he becomes aware of a defect during an earlier flight, make the entries as aforesaid in a technical log at the end of the last of such consecutive flights.

(6) Upon the rectification of any defect which has been entered in a technical log in accordance with paragraph (5) of this regulation, a copy of the certificate of compliance required by regulation 7 of these Regulations in respect of the work done for the rectification of the defect shall be entered in the technical log in such a position or manner as to be readily identifiable with the entry of the defect to which it relates.

(7) The technical log referred to in paragraphs (5) and (6) of this regulation shall be carried in the aircraft when regulation 51 of these Regulations so requires and copies of the entries referred to in those paragraphs shall be kept on the ground.

(8) Subject to the provisions of regulation 53 of these Regulations, every certificate of maintenance shall be preserved by the operator of the aircraft for a period of two years following the expiry of the period of validity of the certificate and for such further period as the Minister may require in any particular case.

## **7. Inspection, overhaul, repair, replacement and modification**

(1) An aircraft registered in Nigeria, being an aircraft in respect of which a certificate of airworthiness issued or rendered valid under these Regulations is in force, shall not fly if any part of the aircraft or of such of its equipment as is necessary for the airworthiness of the aircraft has been overhauled, repaired, replaced or modified or has been inspected as provided in paragraph (7) (b) of regulation 5 of these Regulations, unless there is in force a certificate of compliance issued in accordance with this regulation and relating to the overhaul, repair, replacement, modification or inspection, as the case may be:

Provided that if a repair or replacement of a part of an aircraft or its equipment is carried out when the aircraft is at such a place that it is not reasonably practicable-

(a) for the repair or replacement to be carried out in such manner that a certificate of compliance can be issued under this regulation in respect thereof; or

(b) for such a certificate to be issued while the aircraft is at that place, the aircraft may fly to a place at which such a certificate can be issued, being the nearest place-

(i) to which the aircraft can in the reasonable opinion of the commander thereof, safely fly by a route for which it is properly equipped; and

(ii) to which it is reasonable to fly having regard to any hazards to the liberty or health of any person on board,

and in such case the commander of the aircraft shall cause written particulars of the flight, and the reasons for making it, to be given to the Minister within ten days thereafter.

(2) Neither-

(a) equipment provided in compliance with the Fifth Schedule to these Regulations (except paragraph (3) thereof); nor

[Fifth Schedule.]

(b) in the case of a public transport aircraft, radio apparatus provided for use therein or in any survival craft carried therein, whether or not such apparatus is provided in compliance with these Regulations or any regulation made thereunder,

shall be installed, or placed on board for use, in an aircraft registered in Nigeria after being overhauled, repaired, or modified, unless there is in force in respect thereof at the time when it is installed or placed on board, a certificate of compliance issued in accordance with this regulation and, relating to the overhaul, repair or modification, as the case may be.

(3) For the purposes of these Regulations, "**certificate of compliance**" means a certificate that the part of the aircraft or its equipment has been overhauled, repaired, replaced or modified, as the case may be, in a manner and with material of a type approved by the Minister either generally or in relation to a class or type of aircraft or the particular aircraft and which identifies the aircraft and the overhaul, repair, replacement or modification to which it relates and includes particulars of the work done; and in relation to an inspection required by the Minister, that the inspection has been made in accordance with the requirement of the Minister and that any consequential repair or replacement has been carried out as aforesaid.

(4) A certificate of compliance may be issued for the purposes of this regulation only by-

(a) the holder of a licence granted under these Regulations as an aircraft maintenance engineer or aircraft radio maintenance engineer being a licence of a category appropriate in accordance with regulation 8 of these Regulations and the Fourth Schedule to these Regulations; or

[Fourth Schedule.]

(b) the holder of a licence as such an engineer granted under the law of a country other than Nigeria and rendered valid under these Regulations, in accordance with the privileges endorsed on the licence; or

(c) a person approved by the Minister as being competent to issue such certificates; or

(d) a person whom the Minister has authorised to issue the certificate in a particular case.

(5) Subject to the provisions of regulation 53 of these Regulations, if the aircraft to which a certificate of compliance relates is a public transport aircraft or any aerial work aircraft, the certificate of compliance shall be preserved by the operator of the aircraft for the period of time for which he is required to preserve the log book relating to the same part of the aircraft or to the same equipment or apparatus, as the case may be. In the case of any other aircraft, the certificate shall be preserved by the operator of the aircraft for a period of two years.

## **8. Licensing of aircraft maintenance engineers**

(1) The Minister may grant to any person a licence to act for the purposes of these Regulations as an aircraft maintenance engineer, or an aircraft radio maintenance engineer, of one of the categories specified in the Fourth Schedule to these Regulations, upon his being satisfied that the applicant is a fit and proper person to hold the licence and is qualified by his knowledge and experience to do so, and for that purpose the applicant shall furnish such evidence and undergo such examinations and tests as the Minister may require of him. The Minister may include a rating in the licence limiting the licence to particular types of aircraft or equipment.

[Fourth Schedule.]

(2) A licence of any category shall, subject to any rating as aforesaid, entitle the holder to issue certificates of maintenance, certificates of compliance or certificates of fitness for flight in accordance with the Fourth Schedule to the Regulations.

[Fourth Schedule.]

(3) A licence and a rating shall, subject to the provisions of regulation 54 of these Regulations, remain in force for the periods specified therein, not exceeding twelve months, but may be renewed by the Minister, from time to time, upon his being satisfied that the applicant is a fit and proper person and is qualified as aforesaid.

(4) The Minister may issue a certificate rendering valid for the purposes of these Regulations any licence as an aircraft maintenance engineer or aircraft radio maintenance engineer granted under the law of any country other than Nigeria. Such certificate may be issued subject to such conditions, and for such periods, as the Minister thinks fit.

(5) Upon receiving a licence granted under this regulation, the holder shall forthwith sign his name thereon in ink with his ordinary signature.

## **9. Equipment of aircraft**

(1) An aircraft shall not fly unless it is so equipped as to comply with the law of the country in which it is registered, and to enable lights and markings to be displayed, and signals to be made, in accordance with these Regulations and any regulations made thereunder.

(2) In the case of aircraft registered in Nigeria, the equipment required to be provided (in addition to any other equipment required by or under these Regulations) shall be that specified in such parts of the Fifth Schedule to these Regulations as are applicable in the circumstances and shall comply with the provisions of that Schedule. The equipment, except that specified in paragraph (3) of the said Schedule, shall be of a type approved by the Minister either generally or in relation to a class or type of aircraft or in relation to that aircraft and shall be installed in a manner so approved.

[Fifth Schedule.]

(3) In any particular case, the Minister may direct that an aircraft registered in Nigeria shall carry such additional or special equipment or supplies as he may specify for the purpose of facilitating the navigation of the aircraft, the carrying out of search and rescue operations, or the survival of the persons carried in the aircraft.

(4) The equipment carried in compliance with this regulation shall be so installed or stowed and kept stowed, and so maintained and adjusted, as to be readily accessible and capable of being used by the person for whose use it is installed.

(5) The position of equipment provided for emergency use shall be indicated by clear markings in or on the aircraft. In particular, there shall be exhibited in a prominent position in every passenger compartment of every public transport aircraft registered in Nigeria, a notice stating where the lifejackets (if any) are to be found, and containing instructions as to how they are to be used.

(6) All equipment installed or carried in an aircraft, whether or not in compliance with this regulation, shall be so installed or stowed and kept stowed and so maintained and adjusted as not to be a source of danger in itself or to impair the airworthiness of the aircraft or the proper functioning of any equipment or services necessary for the safety of the aircraft.

(7) This regulation shall not apply in relation to radio apparatus except that specified in the Fifth Schedule to these Regulations.

[Fifth Schedule.]

## **10. Radio equipment of aircraft**

(1) An aircraft shall not fly unless it is so equipped with radio apparatus as to comply with the law of the country in which the aircraft is registered and to enable communications to be made, and the aircraft to be navigated, in accordance with the provisions of these Regulations and any other regulations made thereunder.

(2) In the case of aircraft registered in Nigeria, the aircraft shall be equipped with radio apparatus in accordance with the Sixth Schedule to these Regulations.

[Sixth Schedule.]

(3) In any particular case the Minister may direct that an aircraft registered in Nigeria shall carry such additional or special radio apparatus as he may specify for the purpose of facilitating the navigation of the aircraft, the carrying out of search and rescue operations or the survival of the persons carried in the aircraft.

(4) The radio apparatus provided in compliance with this regulation in an aircraft registered in Nigeria shall always be maintained in serviceable condition.

(5) All radio apparatus installed in an aircraft registered in Nigeria (whether or not in compliance with these Regulations or any regulations made thereunder) shall be of a type approved by the Minister in relation to the purpose for which it is to be used, and shall, except in the case of a glider which is permitted by paragraph (1) of regulation 1 of these Regulations to fly unregistered, be installed in a manner approved by the Minister. Neither the apparatus nor the manner in which it is installed shall be modified except with the approval of the Minister.

#### **11. Aircraft, engine and propeller log books to be kept**

(1) In addition to any other log books required by or of under these Regulations, the following log books shall be kept in respect of every public transport aircraft and aerial work aircraft registered in Nigeria-

- (a) an aircraft log book;
- (b) a separate log book in respect of each engine fitted in the aircraft; and
- (c) a separate log book in respect of each variable pitch propeller fitted to the aircraft.

The log books shall include the particulars respectively specified in the Seventh Schedule to these Regulations.

[Seventh Schedule.]

(2) Each entry in the log book shall be made as soon as practicable after the occurrence to which it relates, but in no event more than seven days after the expiration of the certificate of maintenance (if any) in force in respect of the aircraft at the time of the occurrence.

(3) Entries in a log book may refer to other documents, which shall be clearly identified, and any other documents so referred to shall be deemed, for the purposes of these Regulations, to be part of the log book.

(4) It shall be the duty of the operator of every aircraft in respect of which log books are required to be kept as aforesaid, to keep them or cause them to be kept in accordance with the foregoing provisions of this regulation.

(5) Subject to the provisions of regulation 53 of these Regulations, every log book shall be preserved by the operator of the aircraft until a date two years after the aircraft, the engine or the variable pitch propeller, as the case may be, has been destroyed or has been permanently withdrawn from use.

## **12. Aircraft weight schedule**

(1) Every flying machine and glider in respect of which a certificate of airworthiness issued or rendered valid under these Regulations is in force shall be weighed, and the position of its centre of gravity determined, at such time and in such manner as the Minister may require in the case of that aircraft.

(2) Upon the aircraft being weighed as aforesaid, the operator of the aircraft shall prepare a weight schedule showing the basic weight of the aircraft, that is to say, the weight of the aircraft empty together with the weight of unusable fuel and unusable oil in the aircraft and of such items of equipment as are indicated in the weight schedule; and showing the position of the centre of gravity of the aircraft when the aircraft contains only the items included in the basic weight.

(3) Subject to the provisions of regulation 53 of these Regulations, the weight schedule shall be preserved by the operator of the aircraft until the expiry of a period of six months following the next occasion on which the aircraft is weighted for the purposes of this regulation.

## **13. Access and inspection for airworthiness purposes**

The Minister may cause such inspections, investigations, tests, experiments and flight trials to be made as he deems necessary for the purposes of this Part of these Regulations, and any person authorised to do so in writing by the Minister may at any reasonable time inspect any part of, or material intended to be incorporated in or used in the manufacture of any part of an aircraft or its equipment or any documents relating thereto and may for that purpose go upon any aerodrome or aircraft factory.

### PART III

#### *Aircraft crew and licensing*

## **14. Composition of crew of aircraft**

(1) An aircraft shall not fly unless it carries a flight crew of the number and description required by the law of the country in which it is registered.

(2) An aircraft registered in Nigeria shall carry a flight crew adequate in number and description to ensure the safety of the aircraft and of at least the number and description specified in the certificate of airworthiness issued or rendered valid under these Regulations or, if no certificate of airworthiness is required under those Regulations to be in force, the certificate of airworthiness, if any, last in force under these Regulations, in respect of that aircraft.

(3) A flying machine registered in Nigeria and flying for the purpose of public transport, having a maximum total weight authorised of more than 22,500 lb., shall carry not less than two pilots as members of the flight crew thereof.

(4) An aircraft registered in Nigeria engaged on a flight for the purpose of public transport, shall carry a flight navigator as a member of the flight crew if on the route or any diversion therefrom being a route or diversion planned before take-off, the aircraft is intended to be more than 500 nautical miles from

the point of take-off measured along the route to be flown and to pass over part of an area specified in the Eighth Schedule to these Regulations. The flight navigator carried in compliance with this paragraph shall be carried in addition to any person who is carried in accordance with this regulation to perform other duties.

[Eighth Schedule.]

(5) An aircraft registered in Nigeria, which is required by the provisions of regulation 10 of these Regulations to be equipped with radio communication apparatus shall carry a flight radio operator as a member of the flight crew, who, if he is required to operate radiotelegraph apparatus, shall be carried in addition to any other person who is carried in accordance with this regulation to perform other duties.

(6) If it appears to him to be expedient to do so in the interests of safety, the Minister may direct any particular operator that the aircraft operated by him or any such aircraft shall not fly in such circumstances as the Minister may specify unless they carry in addition to the flight crew required to be carried therein by the paragraphs (1) to (5) of this regulation such additional persons as members of the flight crew as he may specify in the direction.

(7) (a) When an aircraft registered in Nigeria carries twenty or more passengers on a flight for the purpose of public transport, the crew of the aircraft shall include persons carried for the purpose of performing, in the interest of the safety of passengers, duties to be assigned by the operator or the person in command of the aircraft, but who shall not act as members of the flight crew. The number of such persons carried when the aircraft is carrying the number of passengers specified in column 1 of the table set out at the end of this sub-paragraph shall be not less than the number set opposite that number in column 2 of that table-

*Table*

<i>Column 1</i>	<i>Column 2</i>
20- 50 passengers	1 person
51- 100 passengers	2 persons
100- 150 passengers	3 persons
Over 150 passengers	4 persons

(b) The Minister may give a direction to the operator of any aircraft registered in Nigeria requiring him to include among the crew thereof whenever the aircraft is flying for the purpose of public transport at least one such person as aforesaid, notwithstanding that the aircraft may be carrying fewer than twenty passengers.

**15. Members of flight crew shall hold licences**

(1) Subject to the provisions of this regulation, a person shall not act as a member of the flight crew of an aircraft registered in Nigeria unless he is the holder of an appropriate licence granted or rendered valid under these Regulations:

Provided that a person may, within Nigeria, act as a flight radiotelephony operator without being the holder of such a licence if-

(a) he does so as the pilot of a glider not flying for the purpose of public transport or aerial work, or as a person being trained in an aircraft registered in Nigeria to perform duties as a member of the flight crew of an aircraft; and

(b) he is authorised to operate the radio-telephone station by the holder of the licence granted in respect of that station by the Minister or other appropriate authority under any enactment; and

(c) messages are transmitted only for the purpose of instruction, or of the safety or navigation of the aircraft; and

(d) messages are transmitted only on a frequency exceeding sixty megacycles per second assigned by the Minister for use on flights on which a flight radio-telephony operator acts in one of the capacities specified in paragraph (a) of this proviso; and

(e) the transmitter is pre-set to one or more of the frequencies so assigned and cannot be adjusted in flight to any other frequency; and

(f) the operation of the transmitter requires the use only of external switches; and

(g) the stability of the frequency radiated is maintained automatically by the transmitter.

(2) Subject as aforesaid, a person shall not act as a member of the flight crew required by or under these Regulations to be carried in an aircraft registered outside Nigeria unless-

(a) in the case of an aircraft flying for the purpose of public transport or aerial work he is the holder of an appropriate licence granted or rendered valid under the law of the country in which the aircraft is registered; and

(b) in the case of any other aircraft, he is the holder of an appropriate licence granted or rendered valid under the law of the country in which the aircraft is registered or under these Regulations, and the Minister does not in the particular case give a direction to the contrary.

(3) For the purposes of this regulation, a licence granted under the law of a Contracting State purporting to authorise the holder thereof to act as a member of the flight crew of an aircraft, not being a licence purporting to authorise him to act as a student pilot only shall, unless the Minister in the particular case gives a direction to the contrary, be deemed to be a licence rendered valid under these Regulations but shall not entitle the holder to act as a member of the flight crew of any aircraft flying for the purpose of public transport or aerial work.



(4) Notwithstanding the provisions of paragraph (1) of this regulation, a person may, unless the certificate of airworthiness in force in respect of the aircraft registered in Nigeria for the purpose of undergoing training or tests-

(a) for the grant or renewal of a pilot's licence or for the inclusion, renewal or extension of a rating thereon; or

(b) for admission into any of the naval, military or air forces, without being the holder of an appropriate licence, if the following conditions are complied with-

(i) no other person shall be carried in the aircraft or in an aircraft being towed thereby except a person carried as a member of the flight crew in compliance with these Regulations, a person authorised by the Minister to witness the aforesaid training or tests, or, if the pilot in command of the aircraft is the holder of an appropriate licence, a person carried for the purpose of being trained as a member of the flight crew of an aircraft; and

(ii) the person acting as the pilot of the aircraft without being the holder of an appropriate licence shall not be the pilot in command of the aircraft unless within the period of six months immediately preceding he was either the holder of a pilot's licence (other than a student pilot's licence) granted under these Regulations or was serving as a qualified pilot of aircraft in any of the military, naval or air forces, and his physical condition has not, so far as he is aware, so deteriorated during that period as to render him unfit for the licence for which he intends to qualify.

(5) Notwithstanding the provisions of paragraph (1) of this regulation, a person may act as a member of the flight crew of an aircraft registered in Nigeria without being the holder of an appropriate licence if, in so doing, he is acting in the course of his duty as a member of any of the navy, military or air forces.

(6) An appropriate licence for the purposes of this regulation, means a licence which entitles the holder to perform the functions which he undertakes in relation to the aircraft concerned and the flight on which it is engaged.

(7) This regulation shall not apply to a person (other than a flight radio operator) by reason of his acting as a member of the flight crew of a glider which is not flying for the purpose of public transport or aerial work.

## **16. Grant and renewal of licences to members of flight crew**

(1) The Minister may grant licences subject to such conditions as he thinks fit of any of the following classes-

(a) Student Pilot's licence;

(b) Private Pilot's licence (flying machines);

(c) Commercial Pilot's licence (flying machines);

- (d) Senior Commercial Pilot's licence (flying machines);
- (e) Airline Transport Pilot's licence (flying machines);
- (f) Private Pilot's licence (balloons and airships);
- (g) Commercial Pilot's licence (balloons);
- (h) Commercial Pilot's licence (airships);
- (i) Commercial Pilot's licence (gliders);
- (j) Flight navigator's licence;
- (k) Flight Engineer's licence;
- (l) Flight radiotelephony operator's general licence;
- (m) Flight radiotelephony operator's restricted licence;
- (n) Flight radiotelephony operator's licence;
- (o) Flight radiotelephony operator's temporary licence,

upon his being satisfied that the applicant is a fit and proper person to hold the licence and is qualified by reason of his knowledge, experience, competence, skill and physical fitness to act in the capacity to which the licence relates, and for that purpose the applicant shall furnish such evidence and undergo such examinations and tests (including in particular medical examinations) as the Minister may require of him. A licence of any class shall not be granted to any person who is under the minimum age specified for that class of licence under Part A of the Ninth Schedule of these Regulations.

(2) Subject to any conditions of the licence, a licence shall entitle the holder to perform the functions specified in respect of that licence in Part A of the Ninth Schedule under the heading "privileges":

[Part A.]

Provided that-

(a) subject to the provisions of paragraph (10) of this regulation, and paragraph (4) of regulation 15 and paragraph (1) of regulation 19 of these Regulations, a person shall not be entitled to perform any of the functions specified in Part B of the Ninth Schedule in respect of a rating unless his licence includes that rating;

[Part B.]

(b) a person shall not be entitled to perform any of the functions to which his licence relates if he knows or has reason to believe that his physical condition renders him temporarily or permanently unfit to perform such function.

(3) The Minister may, if he is satisfied that the applicant is qualified as aforesaid to act in the capacity to which the rating relates, include in a licence a rating of any of the classes specified in Part B of the Ninth Schedule, and such rating shall be deemed to form part of the licence and shall entitle the holder to perform such functions as are specified in Part B of the Schedule and may be renewed by any person appointed by the Minister for that purpose, if that person is satisfied by a test that the applicant continues to be competent to perform the functions to which the rating relates. The test shall be carried out either in flight or by means of apparatus approved by the Minister in which flight conditions are simulated on the ground.

(4) A licence and a rating shall, subject to the provisions of regulation 54 of these Regulations, remain in force for the periods indicated in the licence, not exceeding those respectively specified in the Ninth Schedule to these Regulations, and may be renewed by the Minister, from time to time, upon his being satisfied that the applicant is a fit and proper person and is qualified as aforesaid:

[Ninth Schedule.]

Provided that, on any application being made for such renewal, the applicant may be required to satisfy the Minister as to his qualifications with respect to the grant of a licence or rating of the class to which the application relates.

(5) Upon receiving a licence granted under this regulation, the holder shall forthwith sign his name thereon in ink with his ordinary signature.

(6) Every holder of a licence, other than a flight radiotelephony operator's licence, granted under this regulation, shall submit himself to medical examination by a person approved by the Minister upon applying for the renewal of the licence and upon such other occasions as the Minister may require,

(7) Every holder of a licence, other than a flight radiotelephony operator's licence, granted under this regulation or rendered valid under regulation 17 of these Regulations, who suffers-

(a) any personal injury involving incapacity to undertake the functions to which his licence relates; or

(b) any illness involving incapacity to undertake those functions throughout a period of twenty days or more,

shall inform the Minister in writing of such injury or illness, as soon as possible in the case of an injury, and as soon as the period of twenty days has elapsed in the case of illness.

(8) A licence, other than a flight radiotelephony operator's licence granted under this Part of these Regulations, shall be deemed to be suspended upon the occurrence of such an injury, or elapse of such period of illness as is referred to in paragraph (7) of this regulation. The suspension of the licence shall cease-

(a) upon the holder being medically examined under arrangements made by the Minister and pronounced fit to resume his functions under the licence; or

(b) upon the Minister exempting the holder from the requirement of a medical examination, subject to such conditions as the Minister thinks fit.

(9) A licence granted under this regulation shall be deemed to be suspended upon the pregnancy of the holder being diagnosed and shall remain suspended until the holder has been medically examined after the termination of the pregnancy and pronounced fit to resume her duties under the licence.

(10) Nothing in these Regulations shall be taken to prohibit the holder of a commercial pilot's, senior commercial pilot's or airline transport pilot's licence (flying machines) from acting as pilot in command of a flying machine carrying passenger by night by reason of the lack of a night rating in his licence.

#### **17. Validation of licences granted outside Nigeria**

The Minister may issue a certificate of validation rendering valid for the purpose of these Regulations any licence of a member of the flight crew of an aircraft granted under the law of any country other than Nigeria. A certificate of validation may be issued subject to such conditions and for such period as the Minister thinks fit.

#### **18. Personal flying log book**

Every member of a flight crew of an aircraft registered in Nigeria and every person who engages in flying for the purpose of qualifying for the grant or renewal of a licence under these Regulations or undergoing tests or receiving instruction in flying for admission into any of the naval, military or air forces, shall keep a personal flying log book in which the following particulars shall be recorded-

- (a) the name and the address of the holder of a log book;
- (b) particulars of holder's licence (if any) to act as a member of the flight crew of an aircraft;
- (c) the name and address of his employer (if any);
- (d) particulars of all flights made as a member of the flight crew of aircraft, including-
  - (i) the date, time, duration and places of arrival and departure of the flight;
  - (ii) the type and registration marks of the aircraft;
  - (iii) the capacity in which the holder acted in flight;
  - (iv) particulars of any special conditions under which the flight was conducted, including night flying and instrument flying;
  - (v) particulars of any test or examination undertaken whilst in flight.

#### **19. Instruction in flying**

(1) A person shall not give any instruction in flying to any person flying or about to fly a flying machine for the purpose of becoming qualified for-

- (a) the grant of a pilot's licence; or
- (b) the inclusion in a pilot's licence of an aircraft rating entitling the holder of the licence to act as pilot of-
  - (i) a multi-engined aircraft; or
  - (ii) an aircraft of any class appearing in column 4 of the Table in Part A of the First Schedule to these Regulations if he has not been previously entitled under the Act or qualified in any of the naval, military or air forces, to act as pilot of a multi-engined aircraft, or of an aircraft of that class, as the case may be; or

[Part A.]

- (c) the inclusion or variation of any rating, other than an aircraft rating in pilot's licence, unless-
  - (i) the person giving the instruction holds a licence, granted or rendered valid under these Regulations, entitling him to act as pilot in command of the aircraft for the purpose and in the circumstances under which instruction is to be given; and
  - (ii) such licence includes a flying instructor's rating or an assistance flying instructor's rating entitling the holder, in accordance with the privileges specified in the Ninth Schedule to these Regulations in respect of that rating, to give the instruction; and

[Ninth Schedule.]

- (iii) if payment is made for the instruction, such licence entitles the holder to act as pilot in command of an aircraft flying for the purpose of public transport:

Provided that sub-paragraph (iii) of this paragraph shall not apply if the aircraft is owned or operated under arrangements entered into by a flying club of which both the person giving and the person receiving the instruction are members.

(2) For the purpose of this regulation, payment shall be deemed to be made for instruction if any reward is given or promised by any person to any other person in consideration of the flight being made or of the instruction being given or if the instruction is given by a person employed for reward, primarily for the purpose of giving such instruction.

## **20. Minimum age of a glider pilot**

A person under the age of sixteen years shall not act as the pilot in command of a glider.

## PART IV

### *Operation of aircraft*

## **21. Operations manual**

(1) This regulation shall apply to public transport aircraft registered in Nigeria except aircraft used for the time being solely for flights not intended to exceed sixty minutes in duration, which are either-

- (a) flights solely for training persons to perform duties in an aircraft; or
- (b) flights intended to begin and end at the same aerodrome.

(2) (a) The operator of every aircraft to which this regulation applies shall-

- (i) make available to each member of his operating staff an operations manual; and
- (ii) ensure that each copy of the operations manual is kept up to date and that one copy thereof is carried on each flight so as to be available to the members of the flight crew.

(b) Each operations manual shall contain all such information and instructions as may be necessary to enable the operating staff to perform their duties as such, including in particular, information and instructions relating to the matters specified in Part A of the Tenth Schedule to these Regulations:

[Part A.]

Provided that the operations manual shall not be required to contain any information or instructions available in the flight manual accessible to the persons by whom the information or instructions may be required.

(3) The operator of the aircraft shall, if the Minister shall so require, furnish the Minister with a copy of the whole of the operation manual for the time being in effect, or of such parts thereof as the Minister may specify. The operator shall make such amendments of or additions to the operations manual as the Minister may require for the purpose of ensuring the safety of the aircraft or of persons or property carried therein or the safety, efficiency or regularity of air navigation.

(4) For the purposes of this regulation and the Tenth Schedule to these Regulations, "**operating staff**" means the servants and agents employed by the operator, whether or not as members of the crew of the aircraft, to ensure that the flights of the aircraft are conducted in a safe manner, and includes an operator who himself performs those functions.

[Tenth Schedule.]

(5) If, in the course of a flight on which the equipment specified in scale 0 in paragraph 5 of the Fifth Schedule of these Regulations is required to be provided, and said equipment becomes unserviceable, the aircraft shall be operated on the remainder of that flight in accordance with any relevant instructions in the operations manual.

[Fifth Schedule.]

## **22. Responsibilities of a public transport operator**

(1) The operator of an aircraft registered in Nigeria shall not permit the aircraft to fly for the purpose of public transport without first-

(a) designating from among the flight crew a pilot to be the commander of the aircraft for the flight; and

(b) satisfying himself by every reasonable means that the aero-nautical radio stations and navigational aids serving the intended route or any planned diversion therefrom are adequate for the safe navigation of the aircraft; and

(c) satisfying himself by every reasonable means that the aerodromes at which it is intended to take-off or land and any alternate aerodrome at which a landing may be made, are suitable for the purpose and in particular are adequately manned and equipped to ensure the safety of the aircraft and its passengers:

Provided that the operator of the aircraft shall not be required to satisfy himself as to the adequacy of fire-fighting, search, rescue or other services which are required only after the occurrence of an accident.

(2) The operator of an aircraft registered in Nigeria shall not permit any person to be a member of the crew thereof during any flight for the purpose of public transport (except a flight for the sole purpose of training persons to perform duties in aircraft) unless such person has had the training, experience, practice and periodical tests specified in Part B of the Tenth Schedule to these Regulations in respect of the duties which he is to perform and unless the operator has satisfied himself that such person is competent to perform his duties, and in particular to use the equipment provided in the aircraft for that purpose. The operator shall maintain, preserve, produce and furnish information respecting records relating to the foregoing matters in accordance with Part B of the said Tenth Schedule.

[Part B.]

### **23. Loading of public transport aircraft**

(1) The operator of an aircraft registered in Nigeria shall not cause or permit it to be loaded for a flight for the purpose of public transport or any load to be suspended therefrom except under the supervision of a person whom he has caused to be furnished with written instructions as to the distribution and securing of the load so as to ensure that-

(a) the load may safely be carried on the flight; and

(b) any conditions subject to which the certificate of airworthiness in force in respect of the aircraft was issued or rendered valid, being conditions relating to the loading of the aircraft, are complied with.

(2) The instructions shall indicate the weight of the aircraft prepared for service, that is, the aggregate of the basic weight (shown in the weight schedule referred to in regulation 12 of these Regulations) and the weight of such additional items in or on the aircraft as the operator thinks fit to include; and the

instructions shall indicate the additional items included in the weight of the aircraft prepared for service, and shall show the position of the centre of gravity of the aircraft at that weight:

Provided that this paragraph shall not apply in relation to a flight if-

- (a) the aircraft's maximum total weight authorised does not exceed 2,500 lbs.; or
- (b) the aircraft's maximum total weight authorised does not exceed 6,000 lbs. and the flight is intended not to exceed sixty minutes in duration and is either-
  - (i) a flight solely for training persons to perform duties in an aircraft; or
  - (ii) a flight intended to begin and end at the same aerodrome.

(3) The operator of an aircraft shall not cause or permit it to be loaded in contravention of the instructions referred to in paragraph (1) of this regulation.

(4) The person supervising the loading of the aircraft shall, before the commencement of any such flight, prepare and sign a load sheet in duplicate, conforming to the requirements specified in paragraph (6) of this regulation and shall (unless he is himself the commander of the aircraft) submit the load sheet for examination of the commander of the aircraft who shall sign his name thereon:

Provided that the foregoing requirements of this paragraph shall not apply if-

- (a) the load and the distributing and securing thereof upon the next intended flight are to be unchanged from the previous flight and the commander of the aircraft makes and signs an endorsement to that effect upon the load sheet for the previous flight, indicating the date of the endorsement, the place of departure up-on the next intended flight and the next intended place of destination; or
- (b) paragraph (2) of this regulation does not apply in relation to the flight.

(5) One copy of the load sheet shall be carried in the aircraft when regulation 51 of these Regulations so requires until the flights to which it relates have been completed and one copy of that load sheet and of the instructions referred to in this regulation shall be preserved by the operator until the expiration of a period of six months thereafter and shall not be carried in the aircraft.

(6) (a) Every load sheet required by paragraph (4) of this regulation shall contain the following particulars-

- (i) the nationality mark of the aircraft to which the load sheet relates and the registration mark assigned to that aircraft by the Minister;
- (ii) particulars of the flight to which the load sheet relates;
- (iii) the total weight of the aircraft as loaded for that flight;



(iv) the weights of the several items from which the total weight of the aircraft, as so loaded, has been calculated, including in particular the weight of the aircraft prepared for service and the respective total weights of the passengers, crew baggage and cargo intended to be carried on the flight;

(v) the manner in which the load is distributed and the resulting position of the centre of gravity of the aircraft which may be given approximately if and to the extent that the relevant certificate of airworthiness so permits,

and shall include at the foot or end of the load sheet a certificate, signed by the person referred to in paragraph (1) of this regulation as responsible for the loading of the aircraft, that the aircraft has been loaded in accordance with the written instructions furnished to him by the operator of the aircraft, pursuant to this regulation.

(b) For the purpose of calculating the total weight of the aircraft, the respective total weights of the passengers and crew entered in the load sheet shall be computed from the actual weight of each person and for that purpose each person shall be separately weighed:

Provided that in the case of an aircraft with a total seating capacity of 12 or more persons and subject to the provisions of sub-paragraph (c) of this paragraph of this regulation, the weights may be calculated according to the following table and the load sheet shall bear a notation to that effect.

*Table*

	<i>lbs.</i>
Males over 12 years of age .....	165
Females over 12 years of age .....	143
Children aged 2 years or more, but not over 12 years of age .....	85
Infants under 2 years of age .....	17

(c) The commander of the aircraft shall, if in his opinion it is necessary to do so in the interests of safety of the aircraft, require any or all of the passengers or crew to be actually weighed for the purpose of the entry to be made in the load sheet.

#### **24. Operating conditions for public transport aircraft**

(1) An aircraft registered in Nigeria shall not fly for the purpose of public transport, except for the sole purpose of training persons to perform duties in aircraft, unless such requirements as may be prescribed in respect of its weight and related performance are complied with.

(2) The assessment of the ability of an aircraft to comply with paragraph (1) of this regulation shall be based on the information as to its performance contained in the certificate of airworthiness relating to

the aircraft. In the event of the information given therein being insufficient for that purpose, such assessment shall be based on the best information available to the commander of the aircraft.

(3) Such requirements as are contained in the Twelfth Schedule to these Regulations in respect of the weather conditions required for take-off, approach to landing and landing, shall be complied with in respect of every aircraft to which regulation 21 of these Regulations applies.

[Twelfth Schedule.]

(4) A flying machine registered in Nigeria when flying over water for the purpose of public transport shall fly, except as may be necessary for the purpose of take-off or landing, at such an altitude as would enable the aircraft—

(a) if it has one engine only, in the event of the failure of that engine;

(b) if it has more than one engine, in the event of the failure of one of those engines and with the remaining engine or engines operating within the maximum continuous power conditions specified in the certificate of airworthiness relating to the aircraft,

to reach a place at which it can safely land at a height sufficient to enable it to do so.

(5) Without prejudice to the provisions of paragraph (4) of this regulation, an aeroplane in respect of which there is in force under these Regulations a certificate of airworthiness designating the aeroplane as being of performance group X, shall not fly over water for the purpose of public transport so as to be more than sixty minutes' flying time from the nearest shore, unless the aeroplane has more than two power units. For the purposes of this paragraph, flying time shall be calculated at normal cruising speed with one power unit inoperative.

## **25. Weather condition for aircraft not registered in Nigeria**

(1) An aircraft registered in a country other than Nigeria shall not fly for the purpose of public transport unless the operator thereof shall have furnished to the Minister such particulars as he may, from time to time, have required relating to the weather conditions specified by the operator in relation to aerodromes in Nigeria for the purpose of limiting their use by the aircraft for take-off or landing, including any instructions given by the operator in relation to such weather conditions.

(2) The aircraft shall not begin or end a flight at an aerodrome in Nigeria in weather conditions less favourable than those so specified in relation to that aerodrome, or in contravention of the instructions referred to in paragraph (1) of this regulation.

## **26. Pre-flight action by commander of aircraft**

The commander of an aircraft registered in Nigeria shall satisfy himself before the aircraft takes off—

- (a) that the flight can safely be made, taking into account the latest information available as to the route and aerodromes to be used, the weather reports and forecasts available, and any alternative course of action which can be adopted in case the flight cannot be completed as planned;
- (b) that the equipment (including radio apparatus) required by or under these Regulations to be carried in the circumstances of the intended flight is carried and is in a fit condition for use;
- (c) that the aircraft is in every way fit for the intended flight, and that where certificates of maintenance are required by paragraph (1) of regulation 6 of these Regulations to be in force, they are in force and will not cease to be in force during the intended flight;
- (d) that the load carried by the aircraft is of such weight, and is so distributed and secured, that it may safely be carried on the intended flight;
- (e) in the case of a flying machine or airship, that sufficient fuel, oil and engine coolant (if required) are carried for the intended flight, and that a safe margin has been allowed for contingencies, and, in the case of a flight for the purpose of public transport, that the instructions in the operations manual relating to fuel, oil and engine coolant have been complied with;
- (f) in the case of an airship or balloon, that sufficient ballast is carried for the intended flight;
- (g) in the case of a flying machine, that having regard to the performance of the flying machine in the conditions to be expected on the intended flight and to any obstructions at the places of departure and intended destination and on the intended route, it is capable of safely taking off, reaching and maintaining a safe height thereafter, and making a safe landing at the place of intended destination;
- (h) that any pre-flight check system established by the operator and set forth in the operations manual or elsewhere, has been complied with by each member of the crew of the aircraft.

## **27. Pilots to remain at controls**

- (1) The commander of an aircraft registered in Nigeria, being a flying machine or glider, shall cause one pilot to remain at the controls at all times while the aircraft is in flight.
- (2) If the aircraft is required by or under these Regulations to carry two pilots, the commander shall cause both pilots to remain at the controls during take-off and landing.
- (3) Each pilot at the controls shall be secured in his seat by either a safety belt or a safety harness except that during take-off and landing a safety harness shall be used if it is required by regulation 9 of these Regulations to be provided.

## **28. Duties of commander of aircraft for transporting passengers**

- (1) This regulation applies to flights for the purpose of the public transports of passengers by aircraft registered in Nigeria.
- (2) In relation to every flight to which this regulation applies, the commander of the aircraft shall-

(a) before the aircraft takes off, take all reasonable steps to ensure that all passengers are made familiar with the position and method of use of emergency exits, safety belts, safety harnesses, oxygen equipment and lifejackets, and all other devices required by or under these Regulations and intended for use by passengers individually in case of an emergency occurring to the aircraft:

Provided that in relation to lifejackets, this requirement may, except in the case of a seaplane, be complied with at any time before the aircraft reaches a point beyond gliding distance from land;

(b) if the aircraft is not a seaplane but is intended in the course of the flight to reach a point more than thirty minutes' flying time (while flying in still air at the speed specified in the relevant certificate of airworthiness as the speed for compliance with regulations governing flights over water) from the nearest land, take all reasonable steps to ensure that before that point is reached, all passengers are given a practical demonstration of the method of use of the lifejackets required by or under these Regulations for the use of passengers;

(c) if the aircraft is a seaplane, take all reasonable steps to ensure that before the aircraft takes off, all passengers are given a practical demonstration of the method of use of the equipment referred to in sub-paragraph (b) of this paragraph;

(d) before the aircraft takes off, and before it lands, take all reasonable steps to ensure that the crew of the aircraft are properly secured in their seats and that any persons, carried in compliance with paragraph (7) of regulation 14 of these Regulations, are secured in seats which shall be in a passenger compartment and which shall be so situated that they can readily assist passengers;

(e) before the aircraft takes off, and before it lands, and whenever by reason of turbulent air or any emergency occurring during flight he considers the precaution necessary, take all reasonable steps to ensure that all passengers are properly secured in their seats by safety belts or safety harnesses;

(f) in any emergency, take all reasonable steps to ensure that all passengers are instructed in the emergency action which they should take;

(g) except in a case where a pressure greater than 700 millibars is maintained in all passenger and crew compartments throughout the flight, take all reasonable steps to ensure that-

(i) before the aircraft reaches an altitude of 13,000 feet above mean sea level, the method of use of the oxygen provided in the aircraft in compliance with the requirements of regulation 9 of these Regulations is demonstrated to all passengers;

(ii) on reaching such altitude all passengers are recommended to use oxygen;

(iii) during any time exceeding thirty minutes when the aircraft is flying at an altitude exceeding 10,000 feet, but not exceeding 13,000 feet above mean sea level, and at all times when the aircraft is flying at any altitude exceeding 13,000 feet above mean sea level, oxygen is used by all the crew of the aircraft.

## 29. Operation of radio in aircraft

(1) The radio station in an aircraft shall not be operated, whether or not the aircraft is in flight, except in accordance with the conditions of the licence issued in respect of that station under the law of the country in which the aircraft is registered, and by a person duly licensed or otherwise permitted to operate the radio station under that law.

(2) Whenever an aircraft is in flight in such circumstances that it is required by or under these Regulations to be equipped with radio communications apparatus, a continuous radio watch shall be maintained by a member of the flight crew listening to the signals transmitted upon the frequency notified, or designated by a message received from an appropriate aeronautical radio station, for use by that aircraft:

Provided that—

(a) the radio watch may be discontinued or continued on another frequency to the extent that a message as aforesaid so permits; and

(b) the watch may be kept by a device installed in the aircraft if-

(i) the appropriate aeronautical radio station has been informed to that effect and has raised no objection; and

(ii) that station is notified, or in the case of a station situated in a country other than Nigeria, otherwise designated as transmitting a signal suitable for that purpose.

(3) The radio station in an aircraft shall not be operated so as to cause interference which impairs the efficiency of aeronautical telecommunications or navigational services, and in particular emissions shall not be made except as follows-

(a) emissions of the class and frequency for the time being in use, in accordance with general international aeronautical practice, in the airspace in which the aircraft is flying;

(b) distress, urgency and safety messages and signals, in accordance with general international aeronautical practice;

(c) messages and signals relating to the flight of the aircraft in accordance with general international aeronautical practice;

(d) such public correspondence messages as may be permitted by or under the aircraft radio station licence referred to in paragraph (1) of this regulation.

(4) In every aircraft registered in Nigeria which is equipped with radio communication apparatus, a telecommunication log book shall be kept in which the following entries shall be made-

(a) the identification of the aircraft radio station;

- (b) the date and time of the beginning and end of every radio watch maintained in the aircraft and of the frequency on which it was maintained;
- (c) the date and time, and particulars of all messages and signals sent or received, including, in particular, details of any distress traffic sent or received;
- (d) particulars of any action taken upon the receipt of a distress signal or message;
- (e) particulars of any failure or interruption of radio communications and the cause thereof:

Provided that a telecommunication log book shall not be required to be kept in respect of communication by radiotelephony with a radio station on land or on a ship which provides a radio service for aircraft.

(5) The flight radio operator maintaining radio watch shall sign the entries in the telecommunication log book indicating the times at which he began and ended the maintenance of such watch.

(6) The telecommunication log book shall be preserved by the operator of the aircraft until a date six months after the date of the last entry therein.

(7) In any flying machine registered in Nigeria which is engaged on a flight for the purpose of public transport, the pilot and the flight engineer (if any) shall not make use of a hand-held microphone (whether for the purpose of radio communication or of intercommunication within the aircraft) whilst the aircraft is flying in controlled airspace at an altitude less than 15,000 feet above mean sea level or is taking off or landing.

### **30. Towing of gliders**

(1) An aircraft in flight shall not tow a glider unless the certificate of airworthiness issued or rendered valid in respect of the towing aircraft under the law of the country in which that aircraft is registered includes an express provision that it may be used for that purpose.

(2) The length of the combination of towing aircraft, tow rope and glider in flight shall not exceed 500 feet.

(3) The commander of an aircraft which is about to tow a glider shall satisfy himself, before the towing aircraft takes off-

(a) that the tow rope is in good condition and is of adequate strength for the purpose, and that the combination of towing aircraft and glider is capable of flying in the manner referred to in paragraph (g) of regulation 26 of these Regulations;

(b) that signals have been agreed and communication established with persons suitably stationed so as to enable the glider to take off safely;

(c) that emergency signals have been agreed between the commander of the towing aircraft and the commander of the glider, to be used respectively by the commander of the towing aircraft, to indicate

that the tow should immediately be released by the glider, and by the commander of the glider to indicate that the tow cannot be released.

(4) The glider shall be attached to the towing aircraft by means of the tow rope before the aircraft takes off.

### **31. Towing picking up and raising of persons and articles**

(1) Subject to the provisions of this regulation, an aircraft in flight shall not, by means external to the aircraft, tow any articles, other than a glider, or pick up or raise any person, animal or article, unless the certificate of airworthiness issued or rendered valid in respect of that aircraft under the law of the country in which the aircraft is registered includes an express provision that it may be used for that purpose.

(2) An aircraft in flight shall not tow any article, other than a glider, at night or when flight visibility is less than one mile.

(3) The length of the combination of towing aircraft, tow rope, and article in tow, shall not exceed 500 feet.

(4) A helicopter shall not fly at any height over a congested area of a city, town or settlement at any time when an article, person or animal is suspended from the helicopter.

(5) Nothing in this regulation shall—

(a) prohibit the towing, in a reasonable manner, by an aircraft in flight of any radio aerial, any instrument which is being used for experimental purposes, or any signal, apparatus or article required or permitted by or under these Regulations to be towed or displayed by an aircraft in flight;

(b) prohibit the picking up or raising of any person, animal or article in an emergency or for the purpose of saving life;

(c) apply to any aircraft while it is flying in accordance with the "B Conditions" set forth in the Second Schedule to these Regulations;

[Second Schedule.]

(d) be taken to permit the towing or picking up of a glider or otherwise than in accordance with regulation 30 of these Regulations.

### **32. Dropping of persons and articles**

(1) Articles and animals (whether or not attached to a parachute) shall not be dropped, or permitted to drop, from an aircraft in flight so as to endanger persons or property.

(2) Articles, animals and persons (whether or not attached to a parachute) shall not be dropped, or permitted to drop, to the surface from an aircraft flying over Nigeria:

Provided that this paragraph shall not apply to the descent of persons by parachute from an aircraft in an emergency, or to the dropping of articles by, or with the authority of, the commander of the aircraft in the following circumstances-

- (a) the dropping of articles for the purpose of saving life;
- (b) the jettisoning, in case of emergency, of fuel or other articles in the aircraft;
- (c) the dropping of ballast in the form of fine sand or water;
- (d) the dropping of articles solely for the purpose of navigating the aircraft in accordance with ordinary practice or with the provisions of these Regulations;
- (e) the dropping at an aerodrome in accordance with prescribed regulations, of ropes, banners or similar articles towed by aircraft.

(3) For the purposes of this regulation, dropping includes projecting and lowering.

(4) Nothing in this regulation shall prohibit the lowering of any person, animal or article from the helicopter to the surface, if the certificate of airworthiness issued or rendered valid in respect of the helicopter under the law of the country in which it is registered includes an express provision that it may be used for that purpose.

### **33. Carriage of munitions of war prohibited**

(1) An aircraft shall not carry any munitions of war.

(2) It shall be unlawful for any person to take or cause to be taken on board an aircraft, or to deliver or cause to be delivered for carriage thereon, any goods which he knows or has reason to believe or suspect to be munitions of war.

(3) For the purpose of this regulation, "munitions of war" means such weapons and ammunition as are designed for use in warfare.

### **34. Carriage of dangerous goods**

(1) Dangerous goods shall not be carried in an aircraft except as follows-

(a) goods carried in accordance with any regulations which the Minister may make to permit dangerous goods to be carried either in an aircraft generally or in an aircraft of any class or type specified in the Regulations;

(b) goods carried with the written permission of the Minister and in accordance with any conditions to which such permission may be subject;

(c) goods carried in an aircraft with the consent of the operator thereof for the purpose of ensuring the proper navigation or safety of the aircraft or the well-being of any person on board;



(d) goods permitted to be carried under the laws of the country in which the aircraft is registered, if there is in force in relation to such country an agreement between the Federal Government of Nigeria and the government of that country permitting the carriage of dangerous goods within Nigeria in aircraft registered in that country.

(2) Dangerous goods permitted by or under these Regulations to be carried in an aircraft shall not be loaded as cargo therein unless-

(a) the consignor of the goods has furnished the operator of the aircraft with particulars in writing of the nature of the goods and the danger which they give rise to; and

(b) the goods or any container in which they are packed are clearly marked so as to indicate the danger to the person loading the goods in the aircraft.

The operator of the aircraft shall, before the flight begins, inform the commander of the aircraft of the identity of the goods, the danger to which they give rise and the weight or quantity of the goods.

(3) It shall be unlawful for any person to take or cause to be taken on board an aircraft, or to deliver or cause to be delivered for loading thereon, any goods which he knows or has reason to believe or suspect to be dangerous goods, the carriage of which is prohibited by this regulation.

(4) The provisions of this regulation shall be additional to and not in derogation from the provisions of regulation 33 of these Regulations.

### **35. Method of carriage of persons**

A person shall not be in or on any part of an aircraft which is not a part designed for the accommodation of persons, and in particular a person shall not be on the wings or under-carriage of an aircraft. A person shall not be in or on any object, other than a glider or flying machine, towed by or attached to an aircraft in flight:

Provided that a person may have temporary access to-

(a) any part of an aircraft for the purpose of taking action necessary for the safety of the aircraft or of any person, animal or goods therein;

(b) any part of an aircraft in which cargo or stores are carried, being a part which is designated to enable a person to have access thereto while the aircraft is in flight.

### **36. Exits and break-in markings**

(1) This regulation shall apply to every public transport aircraft registered in Nigeria.

(2) Whenever an aircraft to which this regulation applies is carrying passengers, every exit therefrom and every internal door in the aircraft shall, during take-off and landing and during any emergency, be kept free of obstruction and shall not be fastened by locking or otherwise so as to prevent, hinder or delay its use by passengers:

Provided that an exit may be obstructed by cargo if it is an exit which, in accordance with arrangements approved by the Minister, either generally or in relation to a class of aircraft or a particular aircraft, is not required for use by passengers.

(3) Every exit from the aircraft, being an exit intended to be used by passengers in normal circumstances, shall be marked with the word "Exit" in capital letters and every exit; being an exit intended to be used by passengers in an emergency only, shall be marked with the words "Emergency Exit" in capital letters.

(4) (a) Every exit from the aircraft shall be marked with instructions in English and in such other language or languages, if any, as may be prescribed, and with diagrams, to indicate the correct method of opening the exit.

(b) The markings shall be placed on or near the inside surface of the door or other closure of the exit and, if it is openable from the outside of the aircraft, on or near the exterior surface.

(5) (a) Every aircraft to which this regulation applies, being an aircraft of which the maximum total weight authorised exceeds 8,000 lbs., shall be marked upon the exterior surface of the fuselage with markings to show the area (in this paragraph referred to as "break-in areas") which can for purposes of rescue in an emergency, be most readily and effectively broken into by a person outside the aircraft.

(b) The break-in areas shall be rectangular in shape and shall be marked by right-angled corner markings, each arm which shall be four inches in length along its outer edge and one inch in width.

(c) The words "Cut Here in Emergency" shall be marked across the centre of each break-in area in capital letters.

(6) The markings required by this regulation shall-

(a) be painted, or affixed by other equally permanent means;

(b) be red in colour and, in any case in which the colour or the adjacent background is such as to render red markings not readily visible, be outlined in white or some other contrasting colour in such a manner as to render them readily visible;

(c) be kept at all times clean and unobscured.

#### *Imperilling safety of aircraft*

### **37. Imperilling safety of aircraft**

A person shall not wilfully or negligently act in a manner likely to endanger an aircraft or any person therein.

### **38. Imperilling safety of any person or property**

A person shall not wilfully or negligently cause or permit an aircraft to endanger any person or property.

### **39. Drunkenness in aircraft**

(1) A person shall not enter any aircraft when drunk or be drunk in any aircraft.

(2) A person shall not, when acting as a member of the crew of any aircraft or being carried in any aircraft for the purpose of so acting, be under the influence of drink or a drug to such an extent as to impair his capacity so to act.

### **40. Smoking in aircraft**

(1) Notices indicating when smoking is prohibited shall be exhibited in every aircraft registered in Nigeria so as to be visible from each passenger seat therein.

(2) A person shall not smoke in any compartment of an aircraft registered in Nigeria at a time when smoking is prohibited in that compartment by a notice to that effect exhibited by or on behalf of the commander of the aircraft.

### **41. Authority of commander of aircraft**

Every person in an aircraft registered in Nigeria shall obey all lawful commands which the commander of that aircraft may give for the purpose of securing the safety of the aircraft and of persons or property carried therein, or the safety, efficiency or regularity of air navigation.

### **42. Stowaways**

A person shall not secrete himself for the purpose of being carried in an aircraft without the consent of either the operator or the commander thereof or of any other person entitled to give consent to his being carried in the aircraft.

## **PART V**

### *Fatigue of flight crew*

### **43. Application, interpretation and modification of Part V**

(1) Regulations 44 to 48, inclusive, of these Regulations shall apply in relation to an aircraft if, but only if, it is an aircraft registered in Nigeria which is either-

- (a) engaged on a flight for the purpose of public transport; or
- (b) operated by an air transport undertaking:

Provided that the said Regulations shall not apply in relation to a flight made only for the purpose of instruction in flying given by or on behalf of a flying club or a flying school, or a person who is not an air transport undertaking.

(2) In this Part of these Regulations, the following expressions shall, except where the context otherwise requires, have the meanings hereby respectively assigned to them, that is-

(a) "**flight time**", in relation to any person, means all time spent by that person in an aircraft while it is in flight and he is carried therein as a member of the flight crew thereof;

(b) "**duty period**", in relation to any person who flies in an aircraft as a member of the flight crew thereof, means any continuous period throughout which he is, under the provisions of paragraph (3) or (4) of this regulation, to be treated as being on duty:

Provided that where two or more periods which would, but for this proviso, be separate duty periods, are separated by an interval of less than ten hours, the period starting when the first of those duty periods began and finishing when the last of them ended shall be treated as constituting a single continuous duty period;

(c) "**rest period**", in relation to any person, means any continuous period, no part of which forms part of a duty period of that person.

(3) For the purposes of this Part of these Regulations, a person who is employed under a contract of service to fly in an aircraft as a member of the flight crew thereof shall be treated as being on duty at any time when in the course of that employment he flies in any aircraft (whether as a member of its crew or as a passenger and whether or not the aircraft is such an aircraft as is referred to in paragraph (1) of this regulation) or he is otherwise acting in the course of that employment:

Provided that when he is not flying in an aircraft-

(a) subject to paragraph (c) of this proviso, he shall not be treated as being on duty during any period which he is allowed for rest;

(b) subject to paragraph (c) of this proviso, he shall not be treated as being on duty at any time by reason only of his being required at that time to be available at a particular place to report for duty if required to do so;

(c) he shall be treated as being on duty at any time when he is required to be available at a particular place to report for duty if required to do so if-

(i) that place is at an aerodrome; or

(ii) that place, not being at an aerodrome, is a place at which his employer requires persons similarly employed to be available as aforesaid and adequate facilities for rest are not available for his use while he is required to be so available.

(4) For the purposes of this Part of these Regulations, a person who flies in an aircraft as a member of the flight crew thereof, otherwise than in the course of his employment under a contract of service to fly as aforesaid, shall be treated as being on duty at any time when, in connection with any business of operating aircraft, he flies in any aircraft (whether as a member of its crew or as a passenger and whether or not the aircraft is such an aircraft as is referred to in paragraph (1) of this regulation) or does any work.

(5) For the purposes of this Part of these Regulations, references to a person flying in an aircraft as a member of the flight crew thereof, include references to the operator of the aircraft who himself flies in the aircraft in any such capacity and references to the work and other duties which a person is required or permitted by an operator to carry out, shall in any such case be construed as references to any work carried out by that operator in connection with the managements of aircraft or with any business which includes the flying of aircraft.

(6) Notwithstanding the provisions of this regulation and regulations 44 to 50 of these Regulations, the Minister may by Regulations modify or replace the provisions of this regulation (other than this paragraph) or any or all of those Regulations in their application to Nigeria if he considers that the prevention of excessive fatigue of the flight crew of aircraft registered in Nigeria will thereby be more suitably ensured.

#### **44. Duties of operators to prevent fatigue to flight crew**

It shall be the duty of every operator of an aircraft to which this regulation applies to ensure, as respects each person flying as a member of the flight crew of that aircraft, that the periods during which that person is required or permitted by that operator to carry out any work or other duties are so limited in length and frequency, and that that person is afforded such periods for rest, that his said work and duties are not likely to cause him such fatigue while he is flying in the aircraft as may endanger the safety thereof.

#### **45. Limits on flying time, duty periods and rest periods**

(1) Without prejudice to the provisions of regulation 44 of these Regulations, and for the purposes of securing that the requirements of those provisions are complied with, every operator of an aircraft to which this regulation applies, shall establish for every person flying in that aircraft as a member of the flight crew thereof-

- (a) limits on the aggregate of all his flight times during every period of thirty consecutive days;
- (b) limits on his flying duty periods; and
- (c) minimum rest periods which he is to have immediately before any duty period in the course of which he makes any such flight as aforesaid,

being limits and minimum rest periods which the operator is satisfied after taking into account the matters mentioned in paragraph (2) of this regulation, are such that, if every member of the flight crew observes those limits and has those minimum rest periods, the safety of the aircraft on any flight is not likely to be endangered by reason of any fatigue which may be caused by the work or other duties which the members of the flight crew are required or permitted by that operator to carry out. Different limits and different minimum rest periods may be established either for different persons or for different classes of persons and for different circumstances.

(2) The matters which an operator shall take into account in establishing under paragraph (1) of this regulation limits and minimum rest periods as therein mentioned for the persons therein mentioned, are the nature of the work and other duties which those persons will carry out and all circumstances arising out of the carrying out of that work and those duties which may affect the degree of fatigue from which those persons may suffer while they are making a flight in an aircraft to which this regulation applies in any such capacity as is mentioned in paragraph (1) of this regulation.

(3) No limits or minimum rest periods may be established under paragraph (1) of this regulation which would require or permit any person to fly in any aircraft at a time when such flying would constitute a contravention of any of the provisions of regulations 46, 47 and 49 of these Regulations.

(4) An operator of an aircraft to which this regulation applies shall not permit an aircraft to make a flight unless limits and minimum rest periods have been established in accordance with the foregoing provisions of this regulation so as to apply to every member of the flight crew thereof.

(5) Every operator of an aircraft to which this regulation applies shall take all such steps as are reasonably practicable to secure that all limits for the time being established by that operator in accordance with the foregoing provisions of this regulation are observed and that no person for whom minimum rest periods are for the time being so established, makes any flight in an aircraft to which this regulation applies unless, immediately before the duty period in the course of which he makes the flight, he has had the appropriate rest period so established.

(6) Notwithstanding anything contained in the foregoing provisions of this regulation, an operator of an aircraft to which this regulation applies may confer upon the commander of that aircraft a discretion to make, or authorise any person to make a flight in that aircraft in such circumstances that the commander or, as the case may be, that other person, will not observe the limits or will not have had the minimum rest period established by that operator under the foregoing provisions of this regulation and applicable to the commander or that other person:

Provided that the said discretion shall not be exercisable unless the following conditions are fulfilled, that is to say-

(a) that it appears to the commander that-

(i) arrangements had been made for the flight to be made with such a crew and so as to begin and end at such times that if the flight had been made in accordance with those arrangements each member of the crew would have observed the limits and have had the minimum rest periods established by the operator and applicable to them as aforesaid, and that since those arrangements were made, the flight has been or will be prevented from being made in accordance with those arrangements by reason of exceptional circumstances or by reason of circumstances which were not foreseen as likely to prevent that flight from being so made; or

- (ii) the flight is one which ought to be carried out in the interests of the safety or health of any person; and
- (b) the commander is satisfied that the safety of the aircraft on that flight will not be endangered if he or that other person makes that flight.

(7) Every operator of an aircraft to which this regulation applies shall include in every operations manual to be provided under regulation 21 of these Regulations for the use and guidance of the members of the flight crew of that aircraft, or in any case where no such manual is required to be provided by that regulation, in a document which shall be provided for the use and guidance of those members, full particulars of all limits and minimum rest periods for the time being established under the foregoing provisions of this regulation which may affect any of those members, and of any discretion conferred upon the commander of that aircraft under paragraph (6) of this regulation and (without prejudice to the provisions of regulation 21 of these Regulations) every such operator shall, whenever requested to do so by a person authorised in that behalf by the Minister, furnish that person with a copy of all particulars, from time to time, included in any such operations manual or document in accordance with the requirements of this paragraph.

(8) In this regulation, the expression "**flying duty period**" in relation to any person, means the time, reckoned from the beginning of each duty period of that person, in the course of which he is permitted to make any flight to which this regulation applies and after expiration of which he is not in the course of the same duty period, to make any such flight.

#### **46. Maximum flying duty periods for pilots and flight engineers**

(1) Without prejudice to the provisions of regulation 44 of these Regulations, a person shall not fly in an aircraft to which this regulation applies as a pilot or flight engineer thereof in the course of any duty period of that person after more than the specified time has elapsed since the beginning of that duty period.

(2) In paragraph (1) of this regulation, the expression "**the specified time**" means-

- (a) in relation to a person who flies in an aircraft as the only pilot thereof, twelve hours:

Provided that if before the commencement of that flight and during the duty period in the course of which he makes that flight, there has been a period of not less than seven continuous hours throughout which that person has not flown in any aircraft, the foregoing provisions of this subparagraph shall have effect in relation to that flight as if fourteen hours were substituted therein for twelve hours;

- (b) in relation to a person who flies as a pilot of an aircraft in which two or more persons are carried as pilots thereof, sixteen hours:

Provided that the foregoing provisions of this sub-paragraph shall have effect in relation to that flight as if 24 hours were substituted therein for sixteen hours if three or more persons are carried in the aircraft as pilots thereof and the following conditions are fulfilled-

- (i) at least two of the pilots are duly qualified by their respective licences to act as a commander of the aircraft for the purposes of that flight;
- (ii) at least one of the pilots is carried in addition to those members of the flight crew who are required to be carried in the circumstances of the flight by or under these Regulations;
- (iii) suitable facilities for sleeping are available for the use of at least one of the pilots at all times throughout the flight; and
- (iv) each of the pilots has during the duty period in the course of which that flight is made and before the end of that flight, been afforded opportunities of resting for a reasonable time;

(c) in relation to a person who flies as a flight engineer of an aircraft, sixteen hours:

Provided that the foregoing provisions of this sub-paragraph shall have effect in relation to that flight as if 24 hours were substituted therein for sixteen hours if two or more persons are carried in the aircraft as flight engineers thereof and the following conditions are fulfilled-

- (i) at least one of the flight engineers is carried in addition to the members of the flight crew who are required to be carried in the circumstances of the flight by or under these Regulations;
- (ii) suitable facilities for sleeping are available for the use of at least one of the flight engineers at all times throughout the flight; and
- (iii) each of the flight engineers has, during the duty period in the course of which that flight is made and before the end of that flight, been afforded opportunities of resting for a reasonable time.

**47. Minimum rest periods for flight crew**

Without prejudice to the provisions of regulation 44 of these Regulations, a person shall not fly in an aircraft to which this regulation applies as a member of the flight crew thereof, unless immediately before the duty period in the course of which he makes that flight he had a sufficient rest period that is to say, a rest period of a length not less than the minimum length specified in the first column of the Table set out at the end of this regulation and therein set opposite to the length specified in the second column of that Table which corresponds to the length of the duty period of that person which immediately precedes that rest period.

Table A

<i>Minimum length of sufficient rest period</i>	<i>Length of immediately preceding duty period</i>
10 hours .....	Not exceeding 10 hours



11 hours .....	Exceeding 10 but not exceeding 11 hours
12 hours .....	Exceeding 11 but not exceeding 12 hours
13 hours .....	Exceeding 12 but not exceeding 13 hours
14 hours .....	Exceeding 13 but not exceeding 14 hours
15 hours .....	Exceeding 14 but not exceeding 15 hours
16 hours .....	Exceeding 15 but not exceeding 16 hours
18 hours .....	Exceeding 16 but not exceeding 17 hours
20 hours .....	Exceeding 17 but not exceeding 18 hours
22 hours .....	Exceeding 18 but not exceeding 19 hours
24 hours .....	Exceeding 19 but not exceeding 20 hours
26 hours .....	Exceeding 20 but not exceeding 21 hours
28 hours .....	Exceeding 21 but not exceeding 22 hours
30 hours .....	Exceeding 22 but not exceeding 23 hours
32 hours .....	Exceeding 23 hours:

Provided that where a rest period taken by a person at a place which is outside Nigeria and, if he ordinarily resides outside Nigeria, is not within fifty miles of his ordinary place of residence, it shall be deemed to be a sufficient rest period if it includes a period of eight hours falling between 2200 and 0800 hours local time and is of a length not less than the minimum length specified in the first column of Table B in this regulation and therein set opposite to the length specified in the second column of that Table which corresponds to the length of the duty period of that person which immediately precedes that rest period.

Table B

<i>Minimum length of sufficient rest period</i>	<i>Length of immediately preceding duty period</i>
10 hours .....	Not exceeding 10 hours
11 hours .....	Exceeding 10 but not exceeding 11 hours
12 hours .....	Exceeding 11 but not exceeding 12 hours
13 hours .....	Exceeding 12 but not exceeding 14 hours
14 hours .....	Exceeding 14 but not exceeding 17 hours

15 hours .....	Exceeding 17 but not exceeding 19 hours
16 hours .....	Exceeding 19 but not exceeding 21 hours
17 hours .....	Exceeding 21 but not exceeding 23 hours
18 hours .....	Exceeding 23 hours

**48. Records of flight times duty period etc.**

(1) The operator of an aircraft to which this regulation applies shall not cause or permit any person to fly therein unless the operator has in his possession an accurate and up-to-date record maintained by him or by another operator of aircraft in respect of that person and in respect of the 28 days immediately preceding the flight showing-

- (a) the times of the beginning and end of each flight in any aircraft made by that person as a member of its flight crew in the course of any of his duty periods; and
- (b) the times of the beginning and end of each duty period of that person; and
- (c) brief particulars of the nature of the work or other duties carried out by that person during each of his duty periods.

(2) The Minister may prescribe the form and manner in which any records required to be kept under paragraph (1) of this regulation shall be kept and where he has so prescribed and said records shall be kept accordingly.

(3) Subject to the provisions of regulation 53 of these Regulations, the operator of the aircraft shall preserve the records referred to in paragraph (1) of this regulation for a period of at least twelve months after the end of the flight, duty period or rest period to which they relate.

**49. Maximum flight times for flight crew**

(1) A person shall not fly in any aircraft registered in Nigeria as a member of the flight crew thereof at any time on any day after the aggregate of all his flight times (whether arising from flight in an aircraft to which this regulation applies or in any other aircraft) during the period of 28 consecutive days expiring at the end of that day, amounts to 110 hours.

(2) Paragraph 1 of this regulation shall not apply to a flight made in an aircraft which is not such an aircraft as is described in paragraph (1) of regulation 43 of these Regulations if at the time of the flight the aggregate of all the flight times of the person making the flight since he was last medically examined under these Regulations and found fit, does not exceed 110 hours.

(3) In a single pilot operation, a person shall not fly in any aircraft registered in Nigeria as a member of the flight crew thereof at any time on any day after the aggregate of all his flight times during the period of 28 consecutive days, expiring at the end of that day, amounts to 105 hours, except that the foregoing

prohibition shall not apply to a flight made in an aircraft which is not such an aircraft as is described in paragraph (1) of regulation 43.

(4) A person shall not fly any helicopter registered in Nigeria as a member of the flight crew thereof at any time on any day after the aggregate of all his flight times during the period of 28 consecutive days expiring at the end of that day amounts to 100 hours, so however that this paragraph shall not apply to a flight made in an aircraft which is not such an aircraft as is described in paragraph (1) of regulation 43.

#### **50. Provision for particular cases**

(1) Notwithstanding anything contained in regulations 46, 47 and 49 of these Regulations (in these Regulations referred to as "the relevant Regulations"), a person shall be deemed not to have contravened any of the provisions of those Regulations by reason of a flight made at any time by that person or by another person if the first-mentioned person proves-

- (a) that it was due to an unavoidable delay in the completion of the flight that the person so flying was flying at that time; and
- (b) that the said first-mentioned person could not reasonably be expected to have foreseen before the flight began that the delay was likely to occur.

(2) Without prejudice to the provisions of paragraph (2) of regulation 79 of these Regulations and notwithstanding anything contained in the relevant Regulations, the commander of an aircraft may make, or authorise any other person to make, and that other person if so authorised may make, a flight in that aircraft which he would, but for this paragraph, be prohibited from making by virtue of any provision contained in the relevant Regulations if it appears to the commander-

- (a) that arrangements had been made for the flight to be made with such a crew and so as to begin and end at such times that no member of that crew would have been prohibited from making the flight in accordance with those arrangements by any provision contained in the relevant Regulations, and that since those arrangements were made, the flight has been or will be prevented from being made in accordance with those arrangements by reason of exceptional circumstances or by reason of circumstances which were not foreseen as likely to prevent that flight from being made; or
- (b) that the flight is one which ought to be carried out in the interest of the safety or health of any person; or
- (c) that the safety of the aircraft on that flight will not be endangered if he or that other person makes that flight.

(3) Where the commander or any other person makes a flight in an aircraft which he or that other person is permitted to make under paragraph (2) of this regulation, a report in writing that he or that other person has made that flight, giving full particulars of the circumstances in which it was made and the reasons why the commander made that flight, or, as the case may be, authorised that other person

to do so, shall be made as soon as is reasonably practicable by the commander to the operator of the aircraft and in any event by the operator to the Minister; and the operator and the commander shall furnish any authorised person with such further information in his possession relating to the flight and to the circumstances in which it was made as that person may require.

PART VI  
*Documents*

**51. Documents to be carried**

(1) An aircraft shall not fly unless it carries the documents which it is required to carry under the law of the country in which it is registered.

(2) An aircraft registered in Nigeria shall, when in flight, carry documents in accordance with the Eleventh Schedule to these Regulations:

[Eleventh Schedule.]

Provided that, if the flight is intended to begin and end at the same aerodrome and does not include passage over the territory of any country other than Nigeria, the documents may be kept at that aerodrome instead of being carried in the aircraft.

**52. Production of documents**

(1) The commander of an aircraft shall, within a reasonable time after being requested to do so by an authorised person, cause to be produced to that person-

- (a) the certificates of registration and airworthiness in force in respect of the aircraft;
- (b) the licences of its flight crew;
- (c) such other documents as the aircraft is required by regulation 51 of these Regulations to carry when in flight.

(2) The operator of an aircraft registered in Nigeria shall, within a reasonable time after being requested to do so by an authorised person, cause to be produced to that person such of the following documents as may have been requested by that person being documents which are required by or under these Regulations, to be in force or to be carried or preserved-

[Eleventh Schedule.]

- (a) the documents referred to in the Eleventh Schedule to these Regulations as Documents A, B, and G;
- (b) the aircraft log book, engine log books and variable pitch propeller log books required under these Regulations to be kept;
- (c) the weight schedule, if any, required to be preserved under regulation 12 of these Regulations;

(d) in the case of a public transport aircraft or aerial work aircraft, the documents referred to in the Eleventh Schedule to these Regulations as Documents D, E, and F;

(e) any record of flight times, duty periods and rest periods which he is required by paragraph (3) of regulation 48 of these Regulations to preserve, and such other documents and information in the possession or control of the operator, as the authorised person may require for the purpose of determining whether those records are complete and accurate.

(3) The holder of a licence granted or rendered valid under these Regulations shall, within a reasonable time after being requested to do so by an authorised person, cause to be produced to that person his licence, including any certificate of validation. The requirements of this paragraph shall be deemed to have been complied with, except in relation to licences required by regulation 51 of these Regulations to be carried in the aircraft or kept at an aerodrome, if the licence requested is produced within five days after the request has been made, at a police station in Nigeria specified, at the time of the request, by the person to whom the request is made.

(4) Every person required by regulation 18 of these Regulations to keep a personal flying log book shall cause it to be produced within a reasonable time to an authorised person after being requested to do so by him within two years after the date of the last entry therein.

### **53. Preservation of documents, etc.**

A person required by these Regulations to preserve any document by reason of his being the operator of the aircraft shall, if he ceases to be the operator of the aircraft, continue to preserve the documents as if he had not ceased to be the operator, and in the event of his death the duty to preserve the document shall fall upon his personal representative:

Provided that if-

(a) another person becomes the operator of the aircraft and it remains registered in Nigeria he or his personal representative shall deliver to that other person upon demand, the certificates of maintenance and compliance, the log books and the weight schedule which are in force or required to be preserved in respect of that aircraft;

(b) an engine or variable pitch propeller is removed from the aircraft and installed in another aircraft operated by another person and registered in Nigeria he or his personal representative shall deliver to that other person upon demand, the log book relating to that engine or propeller;

(c) any person in respect of whom a record has been kept by him in accordance with regulation 48 of these Regulations, becomes a member of the flight crew of a public transport aircraft registered in Nigeria and operated by another person, he or his personal representative shall deliver those records to that other person upon demand, and it shall be the duty of that other person to deal with the document delivered to him as if he were the first-mentioned operator.

#### **54. Revocation, suspension and variation of certificates, etc.**

(1) The Minister may, if he thinks fit, provisionally suspend any certificate, licence, approval, permission, exemption or other document issued or granted under these Regulations, pending investigation of the case and the Minister may, on sufficient ground being shown to his satisfaction after due enquiry, revoke, suspend or vary any such certificate, licence, approval, permission, exemption or other document.

(2) The holder or any person having the possession or custody of any certificate, licence, approval, permission, exemption, or other document which has been revoked, suspended or varied under these Regulations, shall surrender it to the Minister within a reasonable time after being required to do so by him.

(3) The breach of any condition subject to which any certificate, licence, approval, permission, exemption or other document, other than a licence issued in respect of an aerodrome, has been granted or issued under these Regulations, shall render the document invalid during the continuance of the breach.

#### **55. Offences in relation to documents**

(1) A person shall not with intent to deceive-

(a) use any certificate, licence, approval, permission, exemption or other document issued or required by or under these Regulations which has been forged, altered, revoked or suspended, or to which he is not entitled; or

(b) lend any certificate, licence, approval, permission exemption or other document issued or required by or under these Regulations to, or allow it to be used by, any other person; or

(c) make any false representation for the purpose of procuring for himself or any other person the grant, issue, renewal or variation of any such certificate, licence, approval, permission or exemption or other document.

(2) A person shall not wilfully mutilate, alter or render illegible any log book or other record required by or under these Regulations to be maintained or any entry made therein, or knowingly make, or procure or assist in the making, of, any false entry in or material omission from any such log book or record or destroy any such log book or record during the period for which it is required under these Regulations to be preserved.

(3) All entries in such log books and records shall be made in ink or indelible pencil.

(4) A person shall not wilfully or negligently make in a load sheet any entry which is incorrect in any material particular, or any material omission from such a load sheet.

(5) A person shall not purport to issue any certificate of maintenance or certificate of compliance or any certificate under condition (3) of the "A Conditions" set forth in the Second Schedule to these Regulations unless he is authorised to do so under these Regulations.

[Second Schedule.]

(6) A person shall not issue any such certificate as aforesaid unless he has satisfied himself that all statements in the certificate are correct.

## PART VII

### *Control of air traffic*

#### **56. Rules of the Air and Air Traffic Control**

(1) The Minister may make rules (in these Regulations referred to as "the Rules of the Air and Air Traffic Control") prescribing-

- (a) the manner in which aircraft may move and fly;
- (b) the lights and other signals to be shown or made by aircraft or persons;
- (c) the lighting and marking of aerodromes;
- (d) the air traffic control services to be provided at aerodromes including in particular the licensing of persons providing such services;
- (e) any other provisions for securing the safety of aircraft in flight and in movement and the safety of persons and property on the surface.

(2) Subject to the provisions of paragraph (3) of this regulation, it shall be an offence to contravene, to permit the contravention of, or to fail to comply with the Rules of the Air and Air Traffic Control.

(3) It shall be lawful for the Rules of the Air and Air Traffic Control to be departed from to the extent necessary-

- (a) for avoiding immediate danger; or
- (b) for complying with the law of any country other than Nigeria within which the aircraft then IS.

(4) If any departure from the Rules of the Air and Air Traffic Control is made for the purpose of avoiding immediate danger, the commander of the aircraft shall cause written particulars of the departure, and of the circumstances giving rise to it, to be given within ten days thereafter to the competent authority of the country in whose territory the departure was made or if the departure was made over the high seas, to the Minister.

(5) Nothing in the Rules of the Air and Air Traffic Control shall exonerate any person from the consequences of any neglect in the use of lights or signals or of the neglect of any precautions required by ordinary aviation practice or by the special circumstances of the case.

(6) The Minister may, for the purpose of promoting the safety of aircraft, make regulations as to special signals and other communications to be made by or on an aircraft, as to the course on which and the height at which an aircraft shall fly and as to any other precautions to be observed in relation to the navigation and control of aircraft which the Minister may consider expedient for the purpose aforesaid, and no aircraft shall fly in contravention of any such regulations.

#### **57. Power to prohibit or restrict flying**

(1) Where the Minister deems it necessary in the public interest to restrict or prohibit flying over any area of Nigeria or along any route therein by reason of-

- (a) the intended gathering or movement of a large number of persons;
- (b) the intended holding of an aircraft race or contest or of an exhibition of flying;
- (c) national defence; or
- (d) any other reason affecting the public interest,

the Minister may make regulations prohibiting, restricting or imposing conditions on flight, either generally or in relation to any class or type of aircraft, over any such area or along any such route, and an aircraft shall not fly in contravention of such regulations.

(2) If the commander of an aircraft becomes aware that the aircraft is flying in contravention of any such regulations which have been made for any of the reasons referred to in paragraph (1) (c) of this regulation, he shall forthwith cause a signal of distress to be made by radio or by one of the prescribed visual signals, and shall (unless otherwise instructed by the appropriate air traffic control unit or by a commissioned officer of the naval, military or air forces), cause the aircraft to land at the aerodrome, being an aerodrome suitable for that purpose, which it can reach by flying to the least possible extent over the area to which the regulations relate. The aircraft shall not begin to descend while over such area.

#### **58. Balloons, kites and airships**

(1) Within Nigeria-

- (a) a captive balloon or kite shall not be flown at a height of more than 200 feet above the ground level or within 200 feet of any vessel, vehicle or structure;
- (b) a captive balloon shall not be flown within three miles of an aerodrome;
- (c) a balloon exceeding six feet in any linear dimension at any state of its flight, including any basket or other equipment attached to the balloon, shall not be flown in controlled airspace;



- (d) a kite shall not be flown within three miles of an aerodrome;
- (e) an airship shall not be moored, without the permission in writing of the Minister, and in accordance with any conditions subject to which that permission may be granted.

(2) A captive balloon, when in flight, shall be securely moored, and shall not be left unattended unless it is fitted with a device which ensures its automatic deflation if it breaks free of its moorings.

## PART VIII

### *Air routes and airways, aerodromes, lights and other facilities*

#### **59. Designation of air routes and airways**

(1) The Minister may designate as an air route a defined airspace identified, to the extent necessary, for the application of flight rules and forming a route between two points.

(2) The Minister may designate as an airway a defined airspace which consists of or is within a control area, forms a path identified by an area of specified width on the surface of the earth and is equipped with radio navigational aids.

(3) The Minister may determine the conditions of use of any air route or airway so designated by him.

(4) The Minister shall cause to be notified any such designation or determination as is mentioned in this regulation.

#### **60. Use of Government aerodromes**

The Minister may cause to be notified, subject to such conditions or restrictions as he thinks fit, any Government aerodrome as an aerodrome available for public use.

#### **61. Licensing of aerodromes**

(1) Upon application by the proprietor of any place, the Minister may issue to him in respect of such place an airport licence containing such conditions and restrictions as the Minister thinks fit; and a licence so issued shall, subject to the provisions of regulation 54 of these Regulations, remain in force for such period as may be specified in the licence.

(2) The licensee of an aerodrome licensed under this regulation shall not cause or permit any condition or restriction of the licence to be contravened, but the licence shall not cease to be valid by reason only of such a contravention.

(3) The licensee of an aerodrome licensed under this regulation shall not cause or permit the landing or manoeuvring area of the aerodrome to be enlarged reduced or in any other manner altered without the written permission of the Minister:

Provided that the Minister may waive the foregoing requirements in the case of an aerodrome licensed for private use only.

(4) The Minister may give written notice to the licensee of an aerodrome licensed under this regulation specifying the charges, or the maximum charges, which may be made for the use of the aerodrome (including the making of landings thereat) and for any services or facilities performed or provided at the aerodrome to or for or in connection with aircraft and such notice may also specify the conditions to be observed in relation to those charges and the performance or provision of those services or facilities; and the licensee shall not cause or permit any charges to be made in contravention of any notice so given to him and shall cause particulars of any notice so given to him to be kept exhibited at the aerodrome in such a place and manner as to be readily available for the information of any person affected thereby.

## **62. Places authorised as aerodromes**

Subject to the provisions of these Regulations, the Minister may, by specific or general description, authorise the use of any place as an aerodrome for the purposes of the landing and taking off of such classes or types of aircraft engaged in such classes of operations and subject to such conditions as the Minister specifies in the instrument of authorisation.

## **63. Use of aerodromes**

(1) Subject to the provisions of these Regulations, an aircraft shall not land at or take off from any place in Nigeria other than-

- (a) a Government aerodrome notified as available for public use;
- (b) a licensed aerodrome;
- (c) a place authorised by the Minister for use as an aerodrome.

(2) Subject to the provisions of these Regulations, an aircraft shall not land at or take off from any such aerodrome or place as is referred to in sub-paragraphs (a), (b) and (c) of paragraph (1) of this regulation, except in accordance with the conditions and restrictions, if any, which have been notified with respect to the use of that aerodrome or place.

(3) The prohibitions contained in paragraphs (1) and (2) of this regulation shall not apply in relation to a landing due to accident, stress of weather or other unavoidable cause, but the next subsequent departure from the place at which the landing due to any such cause has been made, shall not be made without the consent of the Minister.

## **64. Power to give directions**

The Minister may, in relation to any aerodrome or air route or airway or air route facility or airway facility, issue such directions as he considers necessary to ensure the safety of aircraft or compliance

with any standards or recommended practices or procedures adopted from time to time in pursuance of the Chicago Convention.

#### **65. Rights of Government aircraft**

Notwithstanding anything contained in these Regulations, all aircraft belonging to or employed in the service of the Government of the Federation of Nigeria shall have access at all times to any Government or licensed aerodrome.

#### **66. Customs airports**

(1) The aerodromes at the places named in the first column of the Thirteenth Schedule to these Regulations are aerodromes where facilities for the purposes of enactments relating to customs, health and immigration are available at all times. The aerodromes at the places named in the second column of the said Schedule are aerodromes where such facilities as are mentioned above are available during the hours of 0730 to 1530 every Monday to Friday, but any aircraft wishing to land at or depart from any of the said aerodromes outside those hours shall give at least 48 hours' prior notice of such landing or departure to the customs, health and immigration authorities at the place where the aerodrome is situated. The aerodrome mentioned in the third column of the said Schedule is one where such facilities as are aforementioned would not normally be available but any aircraft wishing to land at or depart from that aerodrome for the purpose of such enactments shall give at least 48 hours' prior notice of such landing or departure to the customs, health and immigration authorities at the place where the aerodrome is situated.

[LN. 28 of 1979. Thirteenth Schedule.]

(2) The Minister may by order-

(a) designate, subject to such conditions as he may think fit, any aerodrome to be a place of landing or departure of aircraft for the purpose of the enactments for the time being in force relating to customs;

(b) revoke or vary any such designation as aforesaid;

(c) revoke or vary any of the designations contained in paragraph (1) of this regulation and the said Thirteenth Schedule.

[Thirteenth Schedule.]

#### **67. Use of aerodromes by aircraft of Contracting States**

The person in charge of any aerodrome in Nigeria which is open to public use by aircraft registered in Nigeria (whether or not the aerodrome is a licensed airport) shall cause the aerodrome, and all air navigation facilities provided thereat or in connection therewith, to be available for use by aircraft registered in other Contracting States on the same terms and conditions as for use by aircraft registered in Nigeria.

## **68. Noise and vibration on aerodromes**

(1) With reference to subsection (1) of section 10 of the Act, the conditions under which noise and vibration may be caused by aircraft (including military aircraft) on Government airports, licensed aerodromes or on aerodromes at which the manufacture, repair or maintenance of aircraft is carried out by persons carrying on business as manufacturers or repairers of aircraft, shall be as follows, that is to say, that whether in the course of the manufacture of the aircraft or otherwise-

- (a) the aircraft is taking off or landing; or
- (b) the aircraft is moving on the ground or water; or
- (c) the engines are being operated in the aircraft-
  - (i) for the purpose of ensuring their satisfactory performance; or
  - (ii) for the purpose of bringing them to a proper temperature in preparation for, or at the end of, a flight; or
  - (iii) for the purpose of ensuring that the instruments, accessories or other components of the aircraft are in a satisfactory condition.

(2) Subsection (2) of section 10 of the Act shall apply to any aerodrome to which paragraph (1) of this regulation applies.

## **69. Trading within Government aerodromes**

(1) Subject to the provisions of this regulation, a person shall not, within a Government aerodrome, either personally or by his servant or agent, or as the servant or agent of another person-

- (a) sell, for delivery within the aerodrome, or supply any goods or services; or
- (b) carry on, or solicit for, any business; or
- (c) erect, display or distribute, or communicate by sound, any advertisement or public notice,

except in accordance with an authority granted under regulation 70 of these Regulations and the terms and conditions of that authority.

(2) Paragraph (1) of this regulation shall not apply to or in relation to-

- (a) the making or performance, by an air transport operator, of contracts for the carriage of passengers or goods by air, or for the carriage by that operator between the aerodrome and any premises of that operator, of passengers or goods that have been, or are to be carried by that operator by air;
- (b) the advertising, by an air transport operator, of the aforesaid services or other transport services or of tourist facilities at or on any premises of that operator;

(c) the sale or supply to an operator of aircraft of goods or services required for the maintenance or operation of such aircraft or for use or consumption aboard such aircraft;

(d) the doing of any act or thing in such parts of any Government aerodrome (not being an aerodrome which is under the control of the Minister) as are not made available for civil aviation purposes.

#### **70. Authority to trade**

(1) The Minister may, by writing under his hand, grant to a person an authority to do, either personally or by his servants or agents or both, any act or thing which apart from such authority would be prohibited by regulation 69 of these Regulations.

(2) An authority under this regulation-

(a) may be included in, or granted in relation to, a lease, sub-lease or licence in respect of particular land within an aerodrome; and

(b) shall be granted for such period, on such terms and conditions and for such consideration as the Minister thinks fit.

(3) Without prejudice to the generality of paragraph (2) (b) of this regulation and subject to paragraph (4) of this regulation, the terms and conditions contained in an authority under this regulation may include-

(a) such terms and conditions relating to the days on which and the times during which the authority may be exercised as the Minister may, having regard to the special needs of the travelling public, think fit; and

(b) such terms and conditions relating to the inspection of premises, the keeping and inspection of books and records and the inspection and sampling of goods as the Minister deems necessary.

(4) An authority under this regulation to sell or supply intoxicating liquor shall not absolve the holder of the authority from complying with any laws relating to the sale of intoxicating liquor which are applicable at the place where the aerodrome is situated.

#### **71. Aeronautical lights and other facilities**

(1) A person shall not establish or maintain within Nigeria any aeronautical light or air route or airway facility except with the permission of the Minister and in accordance with any conditions subject to which the permission may be granted.

(2) A person shall not alter the character of any aeronautical light or air route or airway facility within Nigeria except with the permission of the Minister and in accordance with any conditions subject to which the permission may be granted.

(3) In the case of an aeronautical light, being a beacon, which is or may be visible from any waters within an area of a lighthouse authority, the Minister shall not give his permission for the purpose of this regulation except with the consent of that authority.

(4) A person shall not wilfully or negligently injure or interfere with any aeronautical light or air route or airway facility established and maintained by, or with the permission of, the Minister.

## **72. Dangerous lights**

(1) A person shall not in Nigeria exhibit at or in the neighbourhood of an aerodrome or in the neighbourhood of an air route or airway facility any light which is liable to endanger the safety of aircraft, whether by reason of glare or by causing confusion with or preventing clear reception of any aeronautical light or air route or airway facility established and maintained by or with the permission of the Minister.

(2) If any light which appears to the Minister to be such a light as aforesaid is exhibited, the Minister may cause a notice to be served upon the owner or occupier of the place where the light is exhibited or upon the person having charge of the light, directing such owner, occupier or person, within a reasonable time to be specified in the notice, to extinguish or to screen effectually the light and to refrain from exhibiting any similar light in the future.

(3) A notice under this regulation may be served personally or may be served by post at the last known address or the last known place of business of the person on whom it is served or at the address of the place where the light is exhibited.

(4) If any owner, occupier or person on whom a notice is served under this regulation fails, within the time specified in the notice, to extinguish or screen effectually the light mentioned in the notice, the Minister may, without prejudice to the provisions of regulation 77 of these Regulations, authorise an officer, with such assistance as he requires, to enter the place where the light is, and extinguish or screen the light, and may recover the expenses incurred in so doing from the owner, occupier or person on whom the notice has been served.

(5) In the case of a light which is or may be visible from any waters within the area of a lighthouse authority, the powers of the Minister under this regulation shall not be exercised except with the consent of that authority.

## **PART IX**

### *General*

## **73. Prohibited areas**

(1) The Minister may by proclamation declare any specifically defined area in Nigeria to be a prohibited area.

(2) Except as may be provided in the proclamation whereby the prohibited area is established, or in any subsequent proclamation issued by the Minister, no aircraft shall fly over, or land in, any prohibited area.

#### **74. Power to prevent aircraft flying**

(1) If it appears to the Minister or an authorised person that any aircraft is intended or likely to be flown-

(a) in such circumstances that any provision of regulations 1, 3, 4, 14, 15, 23 or 33 of these Regulations would be contravened in relation to the flight; or

(b) in such circumstances that the flight would be in contravention of any other provision of these Regulations or any regulations made thereunder and be a cause of danger to any person or property whether or not in the aircraft;

(c) while in a condition unfit for the flight, whether or not the flight would otherwise be in contravention of any provision of these Regulations or of any regulations made thereunder,

the Minister or that authorised person may direct the operator or the commander of the aircraft that he is not to permit the aircraft to make the particular flight or any other flight of such description as may be specified in the direction, until the direction has been revoked by the Minister or by an authorised person, and the Minister or that authorised person may take such steps as are necessary to detain the aircraft.

(2) For the purposes of paragraph (1) of this regulation, the Minister or any authorised person may enter upon and inspect any aircraft.

#### **75. Right of access to aerodromes and other places**

(1) The Minister and any authorised person shall have the right of access at all reasonable times-

(a) to any aerodrome, for the purpose of inspecting the aerodrome; or

(b) to any aerodrome for the purpose of inspecting any aircraft on the aerodrome or any document which he has power to demand under these Regulations, or for the purpose of detaining any aircraft under the provision of these Regulations; and

(c) to any place where an aircraft has landed, for the purpose of inspecting the aircraft or any document which he has power to demand under these Regulations and for the purpose of detaining the aircraft under the provisions of these Regulations:

Provided that, subject to paragraph (2) of this regulation, access to a Government aerodrome shall only be obtained with permission of the person in charge of the aerodrome.

(2) Without prejudice to paragraph (1) of this regulation, the Minister may issue aerodrome permits, in the form set out in the Fourteenth Schedule to these Regulations, to such person or persons as he thinks

fit; and the holder of such a permit shall at all times have free and unrestricted access to any part of any Government or licensed aerodrome or of any building erected thereon:

[Fourteenth Schedule.]

Provided that an aerodrome permit issued under this paragraph shall not entitle the holder thereof to enter any customs bonded warehouse.

#### **76. Obstruction of persons**

A person shall not wilfully obstruct or impede any person acting in the exercise of his powers or the performance of his duties under these Regulations.

#### **77. Enforcement of directions**

Any person who fails to comply with any direction given to him by the Minister or by any authorised person under any provision of these Regulations or any regulations made thereunder, shall be deemed for the purposes of these Regulations to have contravened that provision.

#### **78. Fees**

(1) The Minister may prescribe the fees to be paid in respect of the issue, validation, renewal, extension or variation of any certificate, licence or other document (including the issue of a copy thereof) or the undergoing of any examination, test, inspection or investigation or the grant of any permission or approval required by, or for the purpose of these Regulations or any regulations made thereunder, and may also prescribe the conditions of use, including the charges to be made for the use of any Government aero dome by aircraft (including military aircraft).

(2) The Minister may also prescribe charges to be paid in respect of services provided at any Government aerodrome.

#### **79. Penalties**

(1) If any provision of these Regulations or any other regulation made thereunder is contravened in relation to an aircraft, the operator of that aircraft and the commander thereof, if the operator or, as the case may be, the commander, is not the person who contravened that provision shall (without prejudice to the liability of any other person under these Regulations for that contravention) be deemed for the purposes of the following provisions of this regulation to have contravened that provision unless he proves that the contravention occurred without his consent or connivance and that he exercised all due diligence to prevent the contravention.

(2) If it is proved that an act or omission of any person which would otherwise have been a contravention by that person of a provision of these Regulations or of any other regulation made thereunder was due to any cause not avoidable by the exercise of reasonable care by that person the act or omission shall be deemed not to be a contravention by that person of that provision.



(3) Where a person is charged with contravening a provision of these Regulations or of any regulations made thereunder by reason of having been a member of the flight crew of an aircraft on a flight for the purpose of public transport or aerial work, the flight shall be treated (without prejudice to the liability of any other person under these Regulations) as not having been for that purpose if he proves that he neither knew nor had reason to know that the flight was for that purpose.

(4) If any person contravenes any provision of these Regulations, or of any other regulations made thereunder, not being a provision referred to in paragraph (5) or (6) of this regulation, he shall be liable on conviction to a fine not exceeding twenty naira; or in the case of a second or subsequent conviction for the like offence to a fine not exceeding forty naira.

(5) If any person contravenes any provision specified in Part A of the Fifteenth Schedule of these Regulations, he shall be liable on conviction to a fine not exceeding one hundred naira; or in the case of a second or subsequent conviction for the like offence, to a fine of two hundred naira, or to imprisonment for a term not exceeding three months or to both such fine and imprisonment.

[Part A. Fifteenth Schedule.]

(6) If any person contravenes any provision specified in Part B of the Fifteenth Schedule, he shall be liable on conviction to a fine not exceeding four hundred naira or to imprisonment for a term of six months or to both such fine and imprisonment.

[Part B. Fifteenth Schedule.]

## **80. Extra-territorial effect of the Regulations**

Except where the context otherwise requires, the provisions of these Regulations-

(a) in so far as they apply (whether by express reference or otherwise) to aircraft registered in Nigeria, shall apply to such aircraft wherever they may be;

(b) in so far as they apply as aforesaid to other aircraft, shall apply to such aircraft when they are within Nigeria;

(c) in so far as they prohibit, require or regulate (whether by express reference or otherwise) the doing of anything by persons in, or by any of the crew of any aircraft registered in Nigeria, shall apply to such persons and crew, wherever they may be; and

(d) in so far as they prohibit, require or regulate as aforesaid the doing of anything in relation to any aircraft registered in Nigeria by other persons, shall, where such persons are Nigerian citizens, apply to them wherever they may be.

## **81. Power to make Regulations**

The Minister may make regulations for prescribing anything which, under the provisions of these Regulations is to be prescribed.

## **82. Application of Regulations**

(1) Subject to the following provisions of this regulation, the provision of these Regulations shall apply to or in relation to aircraft belonging to or exclusively employed in the service of the Federal or State Governments, not being military aircraft, as they apply to or in relation to other aircraft which are registered in Nigeria or are capable of being so registered and for the purposes of such application, the authority for the time being responsible on behalf of such Government for the management of the aircraft, shall be deemed to be the operator of the aircraft:

Provided that nothing in this regulation shall render liable to any penalty, any Department or other authority responsible on behalf of any such Government for the management of any aircraft.

(2) Save as otherwise provided by paragraph (3) of this regulation, and by regulations 65, 68 and 78 of these Regulations, nothing in these Regulations shall apply to or in relation to any military aircraft.

(3) Where a military aircraft is flown by a civilian pilot and is not commanded by a person who is acting in the course of his duty as a member of any of the naval, military or air forces, the following provisions of these Regulations shall apply on the occasion of that flight, that is to say regulations 37, 38, 39, 57 and 73 and in addition, regulation 56 (so far as applicable) shall apply.

## **83. Exemption**

The Minister may exempt from any of the provisions of these Regulations or any other regulation made thereunder any aircraft or persons or classes or types of aircraft or persons, either absolutely or subject to such conditions as he thinks fit.

## **84. Interpretation**

(1) In these Regulations, unless the context otherwise requires-

"**Act**" means the Civil Aviation Act;

[Cap. C13.]

"**aerial work**" means any purpose (other than public transport) for which an aircraft is flown if hire or reward is given or promised in respect of the flight or the purpose of the flight;

"**aerial work aircraft**" means an aircraft (other than a public transport aircraft) flying, or intended by the operator to fly, for the purpose of aerial work;

"**aerial work undertaking**" means an undertaking whose business includes the performance of aerial work;

"**aerobatic manoeuvres**" includes loops, spins, rolls, bunts, stall turns, inverted flying and any other similar manoeuvre;

**"aerodrome"** means any area of land or water designed, equipped, set apart or commonly used for affording facilities for the take-off and landing of aircraft (not being an area the use of which for those purposes has been abandoned);

**"air route"** means a defined airspace designated by the Minister and notified as an air route;

**"air route facilities"** means facilities (including visual and non-visual navigation aids, visual and non-visual aids to approach and landing at aerodromes, communications services, meteorological services and air traffic control services) provided to promote safe navigation of aircraft within the air space of an air route;

**"airway"** means a defined airspace designated by the Minister, and notified as an airway;

**"airway facilities"** means facilities (including visual and non-visual navigation aids, visual and non-visual aids to approach and landing at aerodromes, communications services, meteorological services and air traffic control services) provided to promote safe navigation of aircraft within the airspace of an airway;

**"aeronautical light"** means any light established for the purpose of aiding air navigation;

**"aeronautical radio station"** means a radio station on the surface, which transmits or receives signals for the purpose of assisting aircraft;

**"air traffic control unit"** means a person appointed by the Minister or by any other person maintaining an aerodrome to give instructions or advice or both by means of radio signals to aircraft in the interests of safety and "air traffic control service" shall be construed accordingly;

**"air transport undertaking"** means an undertaking whose business includes the carriage by air of passengers or cargo for hire or reward;

**"appropriate aeronautical radio station"** means, in relation to an aircraft, an aeronautical radio station serving the area in which the aircraft is for the time being;

**"appropriate air traffic control unit"** means, in relation to an aircraft, the air traffic control unit serving the area in which the aircraft is for the time being;

**"authorised person"**, for the purposes of any provision of these Regulations, means any person authorised by the Minister, either generally or in relation to a particular case or class of cases, and references to an authorised person include references to the holder for the time being of any office designated by the Minister;

**"cargo"** includes mail and animals;

**"certificate of airworthiness"** includes any validation thereof and any flight manual or performance schedule relating to the certificate of airworthiness;

**"certificate of maintenance"** and **"certificate of compliance"** have the meanings respectively assigned to them by paragraph (1) of regulation 6 and paragraph (3) of regulation 7 of these Regulations;

**"Chicago Convention"** means the Convention on International Civil Aviation concluded at Chicago on 7 December 1944, as amended, from time to time;

**"class"**, in relation to aircraft, means class in accordance with the table of general classification of aircraft contained in the First Schedule to these Regulations;

**"commander"**, in relation to an aircraft, means the member of the flight crew designated as commander of that aircraft by the operator thereof, or failing such a person, the person who is for the time being the pilot in command of the aircraft;

**"competent authority"** means, in relation to Nigeria, the Minister and in relation to any other country, the authority responsible under the law of that country for promoting the safety of civil aviation;

**"congested area"** in relation to a city, town or settlement, means any area which is substantially used for residential, industrial, commercial or recreational purposes;

**"Contracting State"** means any state (including Nigeria) which is a party to the Chicago Convention;

**"controlled airspace"** means control areas and control zones;

**"control area"** means airspace which has been notified as such, and which extends upwards from a notified altitude;

**"control zone"** means airspace which has been notified as such and which extends upwards from the surface;

**"co-pilot"**, in relation to an aircraft, means a pilot who in performing his duties as such is subject to the direction of another pilot carried in the aircraft;

**"crew"** has the meaning assigned to it by paragraph (3) of this regulation;

**"flight"** and **"to fly"** have the meanings respectively assigned to them by paragraph (2) of this regulation;

**"flight crew"**, in relation to an aircraft, means those members of the crew of the aircraft who respectively undertake to act as pilot, flight navigator, flight engineer and flight radio operator of the aircraft;

**"Government aerodrome"** means any aerodrome in Nigeria which is under the control of the Minister or is in the occupation of any Government Department;

**"Instrument Flight Rules"** means Instrument Flight Rules prescribed under regulation 56 of these Regulations;

**"to land"**, in relation to aircraft, includes alighting on the water;

"**licence**" includes any certificate of competency or certificate of validity issued with the licence or required to be held in connection with the licence by the law of the country in which the licence is granted;

"**licensed aerodrome**" means an aerodrome licensed under these Regulations;

"**lifejacket**" includes any device designed to support a person individually in or on the water;

"**lighthouse authority**" means any authority in Nigeria in which the care and management of lighthouses is by law vested;

"**maximum total weight authorised**" in relation to an aircraft means the maximum total weight of the aircraft and its contents at which the aircraft may take off in accordance with the certificate of airworthiness in force in respect of the aircraft;

"**military aircraft**" includes the naval, military or air force aircraft of any country and-

(a) any aircraft being constructed for the naval, military or air forces of any country under a contract entered into by the Minister;

(b) any aircraft in respect of which there is in force, a certificate issued by the Minister to the effect that such aircraft is a military aircraft;

"**Minister**" means the Minister responsible for matters relating to civil aviation;

"**nautical mile**" means a distance of 6,080 feet;

"**night**" means the time between sunset and sunrise, sunset and sunrise being determined at surface level;

"**notified**" means shown in any of the following publications issued in Nigeria whether before or after the coming into operation of these Regulations, that is to say, "Notams" (Notices to Airmen), "Information Circulars", or such other official publication so issued for the purpose of enabling any of the provisions of these Regulations to be complied with;

"**operator**" has the meaning assigned to it by paragraph (4) of this regulation;

"**pilot in command**", in relation to an aircraft, means a person who, for the time being, is in charge of the piloting of the aircraft without being under the direction of any other pilot in the aircraft;

"**prescribed**" means prescribed by regulations made by the Minister under these Regulations, and the expression "**prescribe**" shall be construed accordingly;

"**prototype aircraft**" means an aircraft in respect of which an application has been made for a certificate of airworthiness and the design of which has not previously been investigated in connection with any such application;

**"prototype (modified) aircraft"** means an aircraft in respect of which an application has been made for a certificate of airworthiness and the design of which, in part, has not previously been investigated in connection with any such application;

**"public transport"** has the meaning assigned to it by paragraph (5) of this regulation;

**"public transport aircraft"** means an aircraft flying, or intended by the operator of the aircraft to fly, for the purpose of public transport;

**"replacement"**, in relation to any part of an aircraft, or its equipment, includes the removal and replacement of that part whether or not by the same part, and whether or not any work is done on it, but does not include the removal and replacement of a part which is designed to be removable solely for the purpose of enabling another part to be inspected, repaired, removed or replaced or cargo to be loaded;

**"Rules of the Air and Air Traffic Control"** has the meaning assigned to it by paragraph (1) of regulation 56 of these Regulations;

**"scheduled journey"** means one of a series of journeys which are undertaken between the same two places and which together amount to a systematic service;

**"seaplane"** shall be construed as including a flying boat and any other aircraft designed to manoeuvre on the water;

**"State aircraft"** means military aircraft and aircraft used in customs and police services;

**"type"**, in relation to aircraft or engines, means any design which in the opinion of the Minister constitutes a type;

**"Visual Flight Rules"** means Visual Flight Rules prescribed under regulation 56 of these Regulations.

(2) An aircraft shall be deemed to be in flight-

(a) in the case of a piloted flying machine, from the moment when after the embarkation of its crew for the purpose of taking off, it first moves under its own power, until the moment when it next comes to rest after landing;

(b) in the case of a pilotless flying machine, or a glider, from the moment when it first moves for the purpose of taking off until the moment when it next comes to rest after landing;

(c) in the case of an airship or free balloon, from the moment when it first becomes detached from the surface until the moment when it next becomes attached thereto or comes to rest thereon,

and the expressions **"a flight"** and **"to fly"** shall be construed accordingly.

(3) Every person employed or engaged in an aircraft in flight on the business of the aircraft shall be deemed to be a member of the crew thereof.

(4) References in these Regulations to the operator of an aircraft are, for the purpose of the application of any provision of these Regulations in relation to any particular aircraft, references to the person who at the relevant time has the management of that aircraft:

Provided that for the purposes of the application of any provision in Part II of these Regulations, when by virtue of any charter or other agreement for the hire or loan of an aircraft a person other than an air transport undertaking or an aerial work undertaking has the management of that aircraft for a period not exceeding fourteen days, the foregoing provisions of this paragraph shall have effect as if that agreement has not been entered into.

(5) (a) Subject to the provisions of this paragraph, an aircraft in flight shall for the purpose of these Regulations be deemed to fly for the purpose of public transport-

(i) if hire or reward is given or promised for the carriage of passengers or cargo in the aircraft on that flight; or

(ii) if any passengers or cargo are carried gratuitously in the aircraft on that flight by an air transport undertaking, not being persons in the employment of the undertaking (including in the case of a body corporate, its directors), person authorised by the Minister to witness the training or tests referred to in paragraph (4) of regulation 15 of these Regulations, or the training practice or tests referred to in paragraph (2) of regulation 22 of these Regulations, or cargo intended to be used by any such passengers as aforesaid or by the undertaking; or

(iii) for the purpose of Part II of these Regulations, if hire or reward is given or promised for the right to fly the aircraft on that flight otherwise than under a hire-purchase agreement and the expression "**public transport of passengers**" shall be construed accordingly:

Provided that notwithstanding that an aircraft may be flying for the purpose of public transport by reason of sub-paragraph (a) (iii) of this paragraph, it shall not be deemed to be flying for the purpose of public transport of passengers unless hire or reward is given for the carriage of those passengers.

(b) Where under a transaction effected by or on behalf of a member of an unincorporated association of persons on the one hand and the association of persons or any member thereof on the other hand, a person is carried in, or is given the right to fly, an aircraft in such circumstances that hire or reward would be deemed to be given or promised if the transaction were effected otherwise than as aforesaid, hire or reward shall for the purposes of these Regulations, be deemed to be given.

(6) The expressions appearing in the "General Classifications of Aircraft" set forth in Part A of the First Schedule to these Regulations, shall have the meanings hereby assigned to them.

[Part A.]

(7) A power to make regulations under these Regulations shall include the power to make different provisions with respect to different classes or types of aircraft, aerodromes, persons or property and with respect to different circumstances and with respect to different parts of Nigeria.

(8) (a) Any power conferred by these Regulations to issue, make, serve or grant any instrument, shall be construed as including a power exercisable in the like manner and subject to the like conditions, if any, to vary, revoke, cancel or otherwise terminate the instrument;

(b) In this paragraph, "**instrument**" includes any regulation, direction, instruction, rule or other requirement, any notice and any certificate, licence, approval, permission, exemption, log book, record or other document.

(9) The Interpretation Act shall apply for the purpose of interpretation of these Regulations.

[Cap. 123.]

### **85. Saving**

Subject to the provisions of regulations 65 and 67 of these Regulations, nothing in these Regulations or any regulations made thereunder shall confer any right to land in any place as against the owner of the land or other persons interested therein.

### **86. Small aircraft**

The provisions of these Regulations, other than regulations 38 and 58 thereof, shall not apply to-

(a) any balloon which at any stage of its flight is not more than six feet in any linear dimension including any basket or other equipment attached to the balloon;

(b) any kite weighing not more than 4 lb.;

(c) any other aircraft weighing not more than 11 lb. without its fuel.

### **87. Short title**

These Regulations may be cited as the Civil Aviation (Air Navigation) Regulations.

---

## FIRST SCHEDULE

### PART A

[Regulation 2 (6), 19 (1) and 84 (8).]

*Table of general classification of aircraft*



Col. 1	Col. 2	Col. 3	Col. 4
Aircraft	Lighter than air aircraft	<ul style="list-style-type: none"> <li>Non-mechanically driven</li> <li>Mechanically driven</li> <li>Non Mechanically driven</li> </ul>	<ul style="list-style-type: none"> <li>Free Balloon</li> <li>Captive Ballon</li> <li>Airship</li> </ul>
	Heavier than air aircraft	<ul style="list-style-type: none"> <li>Mechanically driven (flying machines)</li> </ul>	<ul style="list-style-type: none"> <li>Glider</li> <li>Kite</li> <li>Aeroplane (Landplane)</li> <li>Aeroplane</li> <li>Aeroplane (Sea plane)</li> <li>Aeroplane (Seaplane)</li> <li>Gyroplane</li> <li>Helicopter</li> </ul>

PART B

[Regulation 3 (2).]

*Nationality and registration marks of aircraft registered in Nigeria*

1. The nationality mark of the aircraft shall be the figure 5 and the capital letter N in Roman character, and the registration mark of the aircraft shall be a group of three capital letters in Roman characters assigned by the Minister on the registration of the aircraft. The letters shall be without ornamentation and a hyphen shall be placed between the nationality mark and the registration mark.

2. The nationality and registration marks shall be painted on the aircraft or shall be affixed thereto by any other means ensuring a similar degree of permanence in the following manner-

1. Position of marks.

(a) Flying machines and gliders

(i) *Wings*: Except on aircraft having no fixed wing surface, the marks shall appear once on the upper surface of the wing structure. They shall be on the right half of the upper surface and on the left half of the lower surface of the wing structure unless they extend across the whole of both the upper and lower surfaces of the wing structure. So far as is

possible the marks shall be located equidistant from the leading and trailing edges of the wings. The tops of the letters shall be towards the leading edge of the wing.

(ii) *Fuselage (or equivalent structure) or vertical tail surface*: The marks shall also be either on each side of the fuselage (or equivalent structure) between the wings and the tail surfaces, or, on the upper halves of the vertical tail surfaces. When on a single vertical tail surface they shall be on both sides of the tail. When there is more than one vertical tail surface, the marks shall appear on the outboard sides of the outer tails.

(b) Airships and balloons

(i) *Airships*: The marks shall be on each side of the airship and also on the upper surface on the line of symmetry. They shall be placed lengthwise near the maximum cross-section of the airship.

(ii) *Spherical balloons*: The marks shall be in two places diametrically opposite. They shall be placed near the maximum horizontal circumference of the balloon.

(iii) *Non-spherical balloons*: The marks shall be on each side. They shall be placed near the maximum cross-section of the balloon immediately above either the rigging band or the points of attachment of the basket suspension cables.

(iv) In the case of all airships and balloons, the side marks shall be so placed as to be visible both from the sides and from the ground.

II. Size of marks.

(a) Flying machines and gliders

(i) *Wings*: The letters constituting each group of marks shall be of equal height. The height of the letters shall be at least twenty inches.

(ii) *Fuselage (or equivalent structure) or vertical tail surfaces*: The marks on the fuselage (or equivalent structure) shall not interfere with the visible outlines of the fuselage (or equivalent structure). The marks on the vertical tail surfaces shall be such as to leave a margin of at least two inches along each side of the vertical tail surface. The letters constituting each group of marks shall be of equal height. The height of the marks shall be at least six inches.

(b) Airships and balloons

The letters constituting each group of marks shall be of equal height. The height of the letters shall be at least 30 inches.

III Width and spacing of marks.

(a) The width of each letter (except the letter I) and the length of the hyphen between the nationality mark and registration mark shall be two thirds of the height of a letter.

(b) The letters and hyphen shall be formed by solid lines and shall be of a colour clearly contrasting with the background on which they appear. The thickness of the lines shall be one sixth of the height of a letter.

(c) Each letter shall be separated from the letter which immediately precedes or follows by a space equal to half the width of a letter. A hyphen shall be regarded as a letter for this purpose.

**3.** The nationality and registration marks shall be displayed to the best advantage, taking into consideration the constructional features of the aircraft, and shall always be kept clean and visible.

**4.** In addition to the foregoing requirements of this Schedule, the nationality and registration marks shall also be inscribed, together with the name and address of the registered owner of the aircraft, on a fireproof metal plate affixed in a prominent position to the fuselage or car or basket as the case may be, and near the main entrance to the aircraft.

---

## SECOND SCHEDULE

[Regulations 1 (1), (2) (b) (ii), 4 (1) (d), 31 (5) (c) and 55 (5).]

### A AND B CONDITIONS

The A conditions or the B conditions referred to in regulations 1 (1), 4, 31 (5) and 55 (5) of these Regulations are as follows-

#### A CONDITIONS-

(1) The aircraft shall be either an aircraft in respect of which a certificate of airworthiness or validation has previously been in force under the provisions of these Regulations, or an aircraft identical in design with an aircraft in respect of which such a certificate is or has been in force.

(2) The aircraft shall fly only for the purpose of enabling it to-

(a) qualify for the issue or renewal of a certificate of airworthiness or of the validation thereof or the approval of a modification of the aircraft, after an application has been made for such issue, renewal validation or approval, as the case may be; or

(b) proceed to or from a place at which any inspection, test or weighing of the aircraft is to take place for a purpose referred to in sub-paragraph (a) of this Schedule.

(3) The aircraft and its engines shall be certified as fit for flight by the holder of a licence as an aircraft maintenance engineer entitled in accordance with the provisions of the Fourth Schedule to these Regulations so to certify, or by a person approved by the Minister for the purpose of issuing certificates under this condition.

(4) The aircraft shall carry the minimum flight crew specified in any certificate of airworthiness or validation which has previously been in force under these Regulations in respect of the aircraft, or is or has been previously in force in respect of any other aircraft of identical design.

(5) The aircraft shall not carry any passengers of cargo except passengers performing duties in the aircraft in connection with the flight.

(6) The aircraft shall not fly over any congested area of a city, town or settlement except to the extent that it is necessary to do so in order to take off from or land at a Government aerodrome or a licensed aerodrome in accordance with normal aviation practice.

(7) Without prejudice to the provisions of paragraph (2) of regulation 14 of these Regulations, the aircraft shall carry such flight crew as may be necessary to ensure the safety of the aircraft.

#### B CONDITIONS-

(1) The flight shall be made under the supervision of a person approved by the Minister for the purposes of these Conditions, and subject to any additional conditions which may be specified in such approval.

(2) If it is not registered in Nigeria or under the law of any country referred to in regulation 1 of these Regulations, the aircraft shall be marked in a manner approved by the Minister for the purposes of these Conditions, and the provisions of regulations 10, 11, 15, 26, 29, 51 and 52 of these Regulations shall be complied with in relation to the aircraft as if it was registered in Nigeria so far as such provisions are applicable to the aircraft in the circumstances.

(3) The aircraft shall fly only for the purpose of-

(a) experimenting with or testing the aircraft (including in particular its engines) and its equipment;  
or

(b) enabling the aircraft to qualify for the issue or validation of a certificate of airworthiness or the approval of a modification of the aircraft; or

(c) proceeding to or from a place at which any experiment, test, inspection or weighing of the aircraft is to take place for a purpose referred to in sub-paragraph (a) or (b).

(4) The aircraft shall carry such flight crew as may be necessary to ensure the safety of the aircraft.

(5) The aircraft shall not carry any passengers performing duties in the aircraft in connection with the flight.

(6) The aircraft shall not fly over any congested area of a city, town, or settlement except to the extent that it is necessary to do so in order to take off from or land at a Government aerodrome, a licensed aerodrome or in accordance with normal aviation practice, or at a place approved by the Minister under condition (1).

---

## THIRD SCHEDULE

### 1. Categories of Aircraft-

Transport Category (Passenger).

Transport Category (Cargo).

Aerial Work Category.

Private Category.

Special Category.

### 2. The purposes for which the aircraft may fly are as follows-

Transport Category (Passenger), any purpose.

Transport Category (Cargo), any purpose, other than the public transport of passengers.

Aerial Work Category: Aerial work only.

Private Category: Any purpose other than public transport or aerial work.

Special Category: Any other purpose specified in the certificate of airworthiness but not including the carriage of passengers unless expressly permitted.

---

## FOURTH SCHEDULE

### *Maintenance Engineers: privileges of licences*

An aircraft maintenance engineer may, subject to the conditions of his licence, issue certificates as follows-

Aircraft Maintenance Engineers - Category A (Aircraft) In relation to aircraft (not including engines)-

(a) certificates of maintenance in accordance with the maintenance schedules approved under these Regulations;

(b) certificates of compliance in respect of inspections, repairs, replacements and modifications so approved;

(c) certificates of fitness of aircraft for flight under the "A Conditions".

Aircraft maintenance engineers - Category B (Aircraft) In relation to aircraft (not including engines)-

Certificates of compliance in respect of inspections, overhauls, repairs, replacements and modifications approved under these Regulations.

Aircraft maintenance engineers - Category C (Engines) In relation to engines-

(a) certificates of maintenance in accordance with the maintenance schedules approved under these Regulations;

(b) certificates of compliance in respect of inspections, repairs, replacements and modifications so approved;

(c) certificates of fitness of aircraft engines for flight under the "A Conditions".

Aircraft maintenance engineers - Category D (Engines) In relation to engines-

Certificates of compliance in respect of inspections, overhauls, repairs, replacement and modifications approved under these Regulations.

Aircraft maintenance engineers-

Category X (Compasses);

Category X (Instruments);

Category X (Electrical);

Category X (Automatic Pilots).

In relation respectively to compasses, instruments, electrical equipment or automatic pilots-

(a) certificates of maintenance in accordance with the maintenance schedules approved under these Regulations;

(b) certificates of compliance in respect of inspections, repairs, replacements and modifications so approved.

Aircraft radio maintenance engineers - Category A (Radio) In relation to aircraft radio stations-

(a) certificates of maintenance in accordance with the maintenance schedules approved under these Regulations;

(b) certificates of compliance in respect of inspections, repairs, replacements and modifications so approved.

Aircraft radio maintenance engineers - Category B (Radio) Certificates of compliance in respect of inspections, overhauls, repairs, replacements and modifications of any aircraft radio apparatus approved under these Regulations.

---

## FIFTH SCHEDULE

### *Aircraft equipment*

1. Every aircraft registered in Nigeria shall be provided, when flying in the circumstances specified in the first column of the Table set forth in paragraph (4) of this Schedule, with adequate equipment and for

the purpose of this paragraph, the expression, "**adequate equipment**" shall mean the scales of equipment, respectively, indicated in that Table:

Provided that, if the aircraft is flying in a combination of such circumstances the scales of equipment shall not on that account be required to be duplicated.

**2.** The equipment carried in an aircraft as being necessary for the airworthiness of the aircraft shall be taken into account in determining whether this Schedule is complied with in respect of that aircraft.

**3.** The following items of equipment shall not be required to be of a type approved by the Minister:

- (i) The equipment referred to in Scale A (ii);
- (ii) First-aid equipment and handbook, referred to in Scale B;
- (iii) Time-pieces, referred to in Scale F;
- (iv) Torches, referred to in Scale G, Hand J;
- (v) Whistles, referred to in Scale H;
- (vi) Sea anchors, referred to in Scales I and J;
- (vii) Rocket signals, referred to in Scale I;
- (viii) Equipment for mooring, anchoring or manoeuvring aircraft on the water, referred to in Scale I;
- (ix) Paddles referred to in Scale J;
- (x) Food and water, referred to in Scale J.





land ..... (d) when flying over water at such a distance from the nearest land that, while flying in still air at the speed specified in the relevant certificate of airworthiness as the speed for compliance with regulations governing flights over water. it would be unable to reach the nearest land in the following times-	A	B		D		only	H											
---	---	---	--	---	--	------	---	--	--	--	--	--	--	--	--	--	--	--

TABLE continued

<i>Aircraft and Circumstances of Flight</i>	<i>Scale of Equipment Required</i>															
	A	B	C	D	E	F	G	H	I	J	K	L	M	N	O	Extras
(i) in the case of an aeroplane classified in its certificate of airworthiness as being of performance group A.C or X - 90 minutes .....																
(ii) in the case of an aeroplane having no performance group classification in the certificate of airworthiness and of such a weight and performance that it is capable of a gradient of climb of at least 1 in 200 at an altitude of 5,000 feet in the international standard atmosphere specified in, or ascertainable by reference to, the certificate of airworthiness in force in respect of that aircraft - 90 minutes .....	A	B		D		F (i) only		H		J						
(iii) in the case of all other flying machines - 30 minutes .....																
(e) on all flights which involve manoeuvres on water.	A	B		D		F (i) only		H	I	J						
(f) when flying at a height of 10,000 feet or more above mean sea level .....	A	B		D		F (i)					K					
(g) on flights when the weather reports or forecasts available at the aerodrome at the time of departure indicate that conditions favouring ice formation are likely to be met .....	A	B	D			F (i) only						L				

<i>Aircraft and Circumstances of Flight</i>	<i>Scale of Equipment Required</i>															
	A	B	C	D	E	F	G	H	I	J	K	L	M	N	O	Extras
<i>(h)</i> when carrying out aerobatic manoeuvres .....	A	B		D		F (i) only							M			



<i>Aircraft and Circumstances of Flight</i>	<i>Scale of Equipment Required</i>															
	A	B	C	D	E	F	G	H	I	J	K	L	M	N	O	Extras
(4) Gliders flying for the purpose of public transport or aerial work .....																
(a) when outside controlled airspace under Instrument Flight Rules .....	A	B		D		F (i) only										
(b) when flying by night .....	A	B	C	D		F (i) only	G									
(c) when carrying out aerobatic manoeuvres .....	A	B		D		F (i) only							M			
(d) on all other flights .....	A	B		D		F (i) only										

(5) The Scales of equipment indicated in the foregoing Table shall be as follows-

Scale A

(i) Spare fuses for all electrical circuits, the fuses of which can be replaced in flight, consisting of ten per cent of the number of each rating or three of each rating, whichever is the greater.

(ii) Maps, charts, codes and other documents and navigational equipment necessary, in addition to any other equipment required under this regulation, for the intended flight of the aircraft, including any diversion which may reasonably be expected.

(iii) Subject to Scale B (iii), a safety belt or safety harness for every seat in use.

Scale B

(i) First-aid equipment of good quality, sufficient in quantity, having regard to the number of persons on board the aircraft, and including the following-

Roller bandages, triangular bandages, absorbent gauze, adhesive plaster, white absorbent lint, cotton wool (or wound dressings in place of the lint and cotton wool), bum dressings safety pins;

Haemostatic bandages or tourniquet, scissors; Antiseptic, analgesic and stimulant drugs;

A handbook on first aid.

(ii) In the case of a flying machine used for the public transport of passengers in which, while the flying machine is at rest on the ground, the sill of any external door intended for the disembarkation of passengers, whether normally or in an emergency-

(a) is more than six feet from the ground when the undercarriage of the machine is in the normal position for taxiing; or

(b) would be more than six feet from the ground if the undercarriage or any part thereof should collapse, break or fail to function,

apparatus readily available for use at each such door consisting of a device or devices which will enable passengers to reach the ground safely in an emergency while the flying machine is on the ground, and can be readily fixed in position for use.

(iii) If the maximum total weight of the aircraft authorised exceeds 6,000 lbs., a safety harness for every pilot's seat in use, in place of the safety belt referred to under Scale A:

Provided that the Minister may permit a safety belt to be fitted if he is satisfied that it is not reasonably practicable to fit a safety harness.

(iv) If the commander cannot, from his own seat, see all the passengers' seats in the aircraft, a means of indicating to the passengers that seat belts should be fastened.

#### Scale C

(i) Equipment for displaying the lights required by the Rules of the Air and Air Traffic Control.

(ii) Electrical equipment, supplied from the main source of supply in the aircraft, to provide sufficient illumination to enable the flight crew properly to carry out their duties during flight.

(iii) Unless the aircraft is equipped with radio, devices for making the visual signal specified in the Rules of the Air and Air Traffic Control as indicating a request for permission to land.

#### Scale D

(i) Either-

(a) a turn and slip indicator; or

(b) a gyroscopic bank and pitch indicator and a gyroscopic direction indicator.

(ii) A sensitive pressure altimeter adjustable for changes in barometric pressure.

#### Scale E

(i) A turn and slip indicator.

- (ii) A gyroscopic bank and pitch indicator.
- (iii) A gyroscopic direction indicator.
- (iv) A sensitive pressure altimeter adjustable for changes in barometric pressure.

#### Scale F

- (i) A time piece with a sweep-second hand.
- (ii) A means of indicating whether the power supply to the gyroscopic instruments is adequate.
- (iii) A rate of climb and descent indicator.
- (iv) If the maximum total weight authorised of the aircraft is more than 12,500 lb., a means of indicating the outside air temperature.
- (v) If the maximum total weight authorised of the aircraft is more than 12,500 lb., two air speed indicators.

#### Scale G

- (i) Landing lights consisting of two single filament lamps, or one dual filament lamp with separately energised filaments.
- (ii) An electrical light system to provide illumination in every passenger compartment.
- (iii)
  - (a) If the aircraft, in accordance with its certificate of airworthiness, may carry more than nineteen persons over three years of age - two electric torches and an emergency lighting system to provide illumination in the passenger compartments sufficient to facilitate the evacuation of the aircraft notwithstanding the failure of the lighting systems specified in sub-paragraph (ii);
  - (b) In the case of any other aircraft, one electric torch for each member of the crew of the aircraft.
- (iv) In the case of an aircraft of which the maximum total weight authorised exceeds 12,500 lb., means of observing the existence and build up of ice on the aircraft.

#### Scale H

For each person on board, a life jacket equipped with a whistle and waterproof torch:

Provided that lifejackets constructed and carried solely for use by children under three years of age need not be equipped with a whistle.

#### Scale I

(i) Additional flotation equipment, capable of supporting one fifth of the number of persons on board, and provided in a place of stowage accessible from outside the flying machine.

(ii) Parachute distress rocket signals capable of making, from the surface of the water, the pyrotechnical signal of distress specified in the Rules of the Air and Air Traffic Control.

(iii) A sea anchor and other equipment necessary to facilitate mooring, anchoring, or manoeuvring the flying machine on water, appropriate to its size, weight and handling characteristics.

(iv) Dinghies sufficient to accommodate all persons on board the flying machine with the following equipment-

- (a) means for maintaining buoyancy;
- (b) a sea anchor;
- (c) lifelines, and means of attaching one dinghy to another;
- (d) paddles or other means of propulsion;
- (e) means of protecting the occupants from the elements;
- (f) a waterproof torch;
- (g) marine type pyrotechnical distress signals;
- (h) means of making seawater drinkable;
- (i) for each person the dinghy is designed to carry-
  - 8 ounces of glucose toffee tablets;
  - 4 ounces of sweetened condensed milk in durable containers;
  - 2 pints of fresh water in durable containers:

Provided that in any case in which it is not reasonably practicable owing to lack of stowage space in the dinghy to carry the quantities of condensed milk and water above prescribed, an equal quantity by weight of glucose toffee tablets may be substituted for the former and as large a quantity of fresh water as is reasonably practicable in the circumstances may be substituted for the latter. In no case however shall the quantity of water carried be less than is sufficient, when added to the amount of fresh water capable of being produced by means of the equipment specified in item (h) of this subparagraph, to provide two pints of water for each person the dinghy is designed to carry;

- (j) first-aid equipment.

Items (f) to (j) inclusive, shall be contained in a pack stowed with the dinghy.

(v) For every four, or proportion of four, dinghies - one dinghy radio transmitter.

## PART I

### Scale K

(i) In every flying machine which is provided with means for maintaining a pressure greater than 700 millibars throughout the flight in the control compartment and in the compartments in which passengers are carried-

- (a) a supply of oxygen sufficient, in the event of failure to maintain such pressure, occurring in the circumstances specified in columns 1 and 2 of the Tables set out in Part II of this Scale, for continuous use, during the periods specified in column 3 of the said Table, by the persons for whom oxygen is to be provided in accordance with column 4 of that Table; and
- (b) in addition, in every case where the flying machine flies at an altitude exceeding 35,000 feet above mean sea level, a supply of oxygen in a portable container sufficient for the simultaneous first-aid treatment of two passengers, together with suitable and sufficient apparatus to enable such persons to use the oxygen.

(ii) In any other flying machines-

- (a) a supply of oxygen sufficient for continuous use by all the crew, and, if passengers are carried, by ten per cent of the number of passengers, for any period exceeding thirty minutes during which the flying machine flies at an altitude exceeding 10,000 feet, but not exceeding 13,000 feet, above mean sea level; and
- (b) a supply of oxygen sufficient for continuous use by all persons on board for the whole time during which the flying machine flies at an altitude exceeding 13,000 feet above mean sea level,

together with suitable and sufficient apparatus to enable such persons to use the oxygen.

## Part II

### Column 1

Attitude above mean sea level at which the flying machine flies...

### Column 2

Capability of flying machine to descend (where relevant)

### Column 3

Period of supply of oxygen

### Column 4

Persons for whom oxygen is to be provided.



Exceeding 10,000 feet.....	-----	30 Minutes or the period specified at A hereunder whichever is the greater	In addition to any passengers for whom oxygen is provided as specified crew.
Exceeding 10,000 feet but not exceeding 35,000 feet.....	Flying machine is either flying at an altitude not exceeding 15,000 feet or is capable of descending and continuing to destination as specified at X hereunder	30 Minutes or the period specified at A hereunder whichever is the greater	10 per cent of number of passengers.
	Flying machine is flying at an altitude exceeding 15,000 feet and is not so capable	30 minutes or the period specified at B hereunder whichever is the greater	All passengers
Exceeding 30,000 feet but not exceeding 35,000 feet.....	Flying machine is capable of descending and continuing to destination as specified at Y hereunder	30 minutes or the period specified at A hereunder whichever is the greater	15 per cent of number of passengers.
Exceeding 35,000 feet.....	Flying machine is not so capable	30 minutes or the period specified at B hereunder whichever is the greater	All passengers
		30 minutes or the period specified at B hereunder whichever is the greater and in addition	All passengers
		30 minutes or the period specified at C hereunder whichever is the greater	15 per cent of passengers.

(ii) The quantity of oxygen required for the purpose of complying with paragraphs (i) and (ii) of this Part of this Scale shall be computed in accordance with the information and instructions relating thereto specified in the operations manual relating to the aircraft pursuant to Item (vA) of Part A of the Tenth Schedule to these Regulations.

A. The whole period during which, after a failure to maintain a pressure greater than 700 millibars in the control compartment and in the compartments in which passengers are carried has occurred, the flying machine flies at an altitude exceeding 10,000 feet above mean sea level.

B. The whole period during which, after a failure to maintain such pressure has occurred, the flying machine flies at an altitude exceeding 15,000 feet above mean sea level.

C. The whole period during which, after a failure to maintain such pressure has occurred, the flying machine flies at an altitude exceeding 10,000 feet, but not exceeding 15,000 feet above mean sea level.

X. The flying machine is capable at the time when a failure to maintain such pressure occurs, of descending in accordance with the emergency descent procedure specified in the relevant flight manual and without flying below the minimum altitudes for safe flight specified in the operations manual relating to the aircraft, from the altitude at which it is then flying to an altitude of 15,000 feet above mean sea level within six minutes, and of continuing at or below that altitude to its place of intended destination or any other place at which a safe landing can be made.

Y. The flying machine is capable, at the time when a failure to maintain such pressure occurs, of descending in accordance with the emergency descent procedure specified in the relevant flight manual and without flying below the minimum altitudes for safe flight specified in the operations manual relating to the aircraft, from the altitude at which it is then flying to an altitude of 15,000 feet above mean sea level within four minutes and of continuing at or below that altitude to its place of intended destination or any other place at which a safe landing can be made.

Scale L

Equipment to prevent the impairment through ice formation of the functioning of the controls, means of propulsion, lifting surfaces, windows or equipment of the aircraft so as to endanger the safety of the aircraft.

Scale M

Safety harness for every seat in use.

Scale N

An intercommunication system for use by all members of the flight crew and including microphones, not of a hand-held type, for use by the pilot and flight engineer (if any).

Scale O

A radar set capable of giving warning to the pilot in command of the aircraft of the presence of cumulo-nimbus clouds and other potentially hazardous weather conditions.

---

SIXTH SCHEDULE

*Radio apparatus to be carried in aircraft*

1. Every aircraft registered in Nigeria shall be provided, when flying in the circumstances specified in the first column of the Table set forth in paragraph (2) of this Schedule, with the scales of equipment respectively indicated in that Table:

Provided that, if the aircraft is flying in a combination of such circumstances, the scales of equipment shall not on that account be required to be duplicated.

2. TABLE

Aircraft and circumstances of flight	Scale of equipment required			
	A	B	C	D
All aircraft-				
(a) when flying under Instrument Flight Rules within controlled airspace				
(b) where required by the Rules of the Air and Air Traffic Control to comply in whole or in part with Instrument Flight Rules in visual meteorological conditions .....	A	B		
(c) when flying within any airspace in respect of which special rules may be prescribed by the said Rules in relation to a particular aerodrome, so as to require two-way radio communication with that aerodrome .....	A+	B+		
(2) All aircraft when flying for the purpose of public transport-				
(a) under Instrument Flight Rules-				
(i) while making an approach to landing .....	A+			
(ii) on all other occasions .....		B	C	D
(b) under Visual Flight Rules-				
(i) over a route on which navigation is not effected solely by visual reference to landmarks .....	A	B	C	
(ii) over water, beyond gliding distance from any land .....	A	B		

Unless the appropriate Air Traffic Control Unit otherwise permits in relation to the particular flight.

3. The scales of radio apparatus indicated in the foregoing Table shall be as follows-

Scale A

Radio apparatus capable of maintaining two-way communication with the appropriate aeronautical radio stations.

Scale B

Radio apparatus capable of enabling the aircraft to be navigated on the intended route.

Scale C

Radio apparatus capable of receiving from the appropriate aeronautical radio stations meteorological broadcasts relevant to the intended flight.

Scale D

Radio apparatus capable of receiving signals from one or more aeronautical radio stations on the surface to enable the aircraft to be guided to a point from which a visual landing can be made at the aerodrome at which the aircraft is to land.

4. All aircraft when flying to, from or over Berlin, Germany shall be equipped with radio navigation apparatus appropriate to the route, including automatic direction finding apparatus and anyone of the following-

(i) apparatus which will enable the aircraft to be navigated by means of signals received from radio navigation land stations forming part of the Decca radio navigation system; or

(ii) apparatus capable of giving both the visual and the aural indications of radio signals received from visual/aural radio ranges; or

(iii) apparatus capable of giving visual indications of bearings of the aircraft by means of signals received from very high frequency omni-directional radio ranges.

In this sub-paragraph, "**automatic-direction finding apparatus**" means radio navigation apparatus which automatically indicates the bearing of any radio station transmitting the signals received by such apparatus, and "**visual/aural radio range**" means a radio navigation land station the signals from which provide track guidance for aircraft along four paths, two of which are identifiable by visual, and two by aural indications at the receiving station in the aircraft.

## *Aircraft, engine and propeller log books*

### **1. Aircraft log book**

The following entries shall be included in the aircraft log book-

- (a) the name of the constructor, the type of the aircraft, the number assigned to it by the constructor and the date of the construction of the aircraft;
- (b) the nationality and registration marks of the aircraft;
- (c) the name and address of the operator of the aircraft;
- (d) particulars of the date and duration of each flight, or, if more than one flight was made on one day, the number of flights and total duration of flights on that day;
- (e) particulars of all maintenance work carried out on the aircraft or its equipment;
- (f) particulars of any defects occurring in the aircraft or in any equipment required to be carried therein by or under these Regulations, and of the action taken to rectify such defects including a reference to the relevant entries in the technical log required by paragraphs (5) and (6) of regulation 6 of these Regulations;
- (g) particulars of any overhauls, repairs, replacements and modifications relating to the aircraft or any such equipment as aforesaid:

Provided that entries shall not be required to be made under sub-paragraph (e), (f) and (g) in respect of any engine or variable pitch propeller.

### **2. Engine log book**

The following entries shall be included in the engine log book-

- (a) the name of the constructor, the type of the engine, the number assigned to it by the constructor and the date of the construction of the engine;
- (b) the nationality and registration marks of each aircraft in which the engine is fitted;
- (c) the name and address of the operator of each aircraft;
- (d) particulars of the date and duration of each occasion on which the engine is run in flight, or, if the engine is run on more than one occasion on one day, the number of occasions and the total duration of the running of the engine on that day;
- (e) particulars of all maintenance work done on the engine;

- (f) particulars of any defects occurring in the engine, and of the rectification of such defects, including a reference to the relevant entries in the technical log required by paragraphs (5) and (6) of regulation 6 of these Regulations;
- (g) particulars of all overhauls, repairs, replacements and modifications relating to the engine or any of its accessories.

### **3. Variable pitch propeller log book**

The following entries shall be included in the variable pitch propeller log book-

- (a) the name of the constructor, the type of the propeller, the number assigned to it by the constructor and the date of the construction of the propeller;
- (b) the nationality and registration marks of each aircraft, and the type and number of each engine, to which the propeller is fitted;
- (c) the name and address of the operator of each such aircraft;
- (d) particulars of the date and duration of each occasion on which the propeller is run in flight, or, if the propeller is run on more than one occasion on one day, the number of occasions and the total duration of the running of the propeller on that day;
- (e) particulars of all maintenance work done on the propeller;
- (f) particulars of any defects occurring in the propeller, and of the rectification of such defects, including a reference to the relevant entries in the technical log required by paragraphs (5) and (6) of regulation 6 of these Regulations;
- (g) particulars of any overhauls, repairs, replacements and modifications relating to the propeller.

---

### **EIGHTH SCHEDULE**

*Areas specified in connection with the carriage of flight navigators as members of the flight crew of public transport aircraft*

The following areas are hereby specified for the purposes of paragraph (4) of regulation 14 of these Regulations.

*Area A-Arctic*

All that area north of latitude 66° 33' north, excluding any part thereof lying within 300 nautical miles of Norway.

*Area B-Antarctic*

All that area south of latitude 50° south.

*Area C-Sahara*

All that area enclosed by rhumb lines joining successively the following points-

32° north latitude.....03° west longitude

24° north latitude.....14° west longitude

14° north latitude.....14° west longitude

18° north latitude.....28° east longitude

24° north latitude.....28° east longitude

28° north latitude.....23° east longitude

32° north latitude.....03° west longitude

*Area D -Arabian Desert*

All that area enclosed by rhumb lines joining successively the following points-

30° north latitude.....38° east longitude

16° north latitude.....46° east longitude

20° north latitude.....52° east longitude

29° north latitude.....43° east longitude

30° north latitude.....38° east longitude

*Area E-South America (Central)*

All that area enclosed by rhumb lines joining successively the following points-

05° north latitude.....75° west longitude

04° north latitude.....60° west longitude

10° south latitude.....40° west longitude

30° south latitude.....60° west longitude

30° south latitude.....70° west longitude

18° south latitude.....69° west longitude

14° south latitude.....75° west longitude

05° south latitude.....80° west longitude

05° north latitude.....75° west longitude

*Area F-South America (Patagonia)*

All that area enclosed by rhumb lines joining successively the following points-

50° south latitude.....75° west longitude

40° south latitude.....75° west longitude

40° south latitude.....62° west longitude

50° south latitude.....65° west longitude

50° south latitude.....75° west longitude

*Area G-Pacific Ocean*

All that area enclosed by rhumb lines joining successively the following points-

50° south latitude.....75° west longitude

20° south latitude.....73° west longitude

05° south latitude.....85° west longitude

05° north latitude.....80° west longitude

15° north latitude.....105° west longitude

30° north latitude.....125° west longitude

55° north latitude.....140° west longitude

67° north latitude.....180° west longitude

60° north latitude.....180° west longitude

20° north latitude.....128° east longitude

04° north latitude.....128° east longitude

00° north latitude.....160° east longitude

50° south latitude.....160° east longitude



50° south latitude.....75° west longitude

excluding any part thereof lying within 300 nautical miles of New Zealand.

*Area H-Australia*

All that area enclosed by rhumb lines joining successively the following points-

18° south latitude.....123° east longitude

26° south latitude.....118° east longitude

30° south latitude.....118° east longitude

30° south latitude.....145° east longitude

26° south latitude.....145° east longitude

21 ° south latitude.....140° east longitude

18° south latitude.....123° east longitude

*Area I-Indian Ocean*

All that area enclosed by rhumb lines joining successively the following points-

50° south latitude.....110° east longitude

20° south latitude.....110° east longitude

13° south latitude.....120° east longitude

10° south latitude.....100° east longitude

18° north latitude.....89° east longitude

00° north latitude.....80° east longitude

24° north latitude.....65° east longitude

05° south latitude.....43° east longitude

20° south latitude.....60° east longitude

25° south latitude.....60° east longitude

30° south latitude.....35° east longitude

50° south latitude.....35° east longitude

50° south latitude.....110° east longitude

*Area J-Atlantic Ocean*

All that area enclosed by rhumb lines joining successively the following points-

50° south latitude.....15° east longitude

05° south latitude.....10° east longitude

02° north latitude.....05° east longitude

02° north latitude.....10° west longitude

15° north latitude.....25° west longitude

55° north latitude.....15° west longitude

67° north latitude.....40° west longitude

67° north latitude.....60° west longitude

45° north latitude.....45° west longitude

40° north latitude.....63° west longitude

19° north latitude.....63° west longitude

05° south latitude.....30° west longitude

50° south latitude.....55° west longitude

50° south latitude.....15° east longitude

---

NINTH SCHEDULE

*Flight crew of aircraft: licence and ratings*

PART A-LICENCES

*Minimum age, period of validity, privileges*

**1. Student pilots**

Student Pilots Licence (flying machines, balloons and airships)

Minimum age - seventeen years

Maximum period of validity-

- (a) 24 months, if the holder is less than forty years of age on the date on which the licence is granted or renewed; or
- (b) twelve months, if the holder is forty years of age or more on that date.

Privileges of the licence-

- (a) shall entitle the holder to fly as pilot in command of an aircraft for the purpose of becoming qualified for the grant or renewal of a pilot's licence;
- (b) shall be valid only for flights within Nigeria and within any other territory specified in the licence;
- (c) shall not entitle the holder to fly as pilot in command of an aircraft in which any person is carried;
- (d) shall be valid only for flights carried out in accordance with instructions given by a person holding a pilot's licence granted under these Regulations, being a licence which includes a flying instructor's rating or an assistant flying instructor's rating entitling him to give instruction in flying the type of aircraft to be flown.

## **2. Flying machine pilots**

Private Pilot's Licence (flying machines) Minimum age - seventeen years. Maximum period of validity-

- (a) 24 months, if the holder is less than forty years of age on the date on which the licence is granted or renewed; or
- (b) twelve months, if the holder is forty years of age or more on that date.

Privileges of the licence-

- (i) shall entitle the holder to fly as pilot in command or co-pilot of a flying machine of any of the types specified in the aircraft rating included in the licence, when the aircraft is flying for any purpose other than public transport or aerial work;
- (ii) shall not entitle the holder to act as pilot in command by night while carrying any passenger in the aircraft unless a night rating is included in the licence, and unless an instrument rating is included therein or he has within the preceding six months carried out as pilot in command not less than five take-offs and five landings at a time when the depression of the centre of the sun is not less than twelve degrees below the horizon.

Commercial Pilot's Licence (flying machines), Minimum age - eighteen years

Maximum period of validity - six months.

Privileges: In addition to the privileges given above for the Private Pilot's Licence the holder of the licence shall be entitled to fly as-

- (i) pilot in command of any flying machine of which the maximum total weight authorized does not exceed 12,500 lb. and which is of type specified in Part 1 of the aircraft rating included in the licence, when the flying machine is engaged in a flight for the purpose of public transport or aerial work:

Provided that-

- (a) he shall not, unless his licence includes an instrument rating, fly such an aircraft on any scheduled journey;

- (b) he shall not fly such an aircraft on a flight carrying passengers at night unless an instrument rating is included in his licence or he has within the immediately preceding ninety days carried out as pilot in command not less than five take-offs and five landings at a time when the depression of the centre of the sun is not less than twelve degrees below the horizon.

- (ii) co-pilot of any flying machine of a type specified in Part 1 or of such aircraft rating when the flying machine is engaged in a flight for the purpose of public transport or aerial work:

Senior Commercial Pilot's Licence (flying machine), Minimum age - 21 years

Maximum period of validity - six months.

Privileges: In addition to the privileges given above for the Private Pilot's Licence the holder of the licence shall be entitled to fly as-

- (i) pilot in command of any flying machine of which the maximum total weight authorised does not exceed 30,000 lb. and which is of a type specified in Part 1 of the aircraft rating included in the licence, when the flying machine is engaged in a flight for the purpose of public transport or aerial work:

Provided that-

- (a) he shall not, unless his licence includes an instrument rating, fly such an aircraft on any scheduled journey;

- (b) he shall not fly such an aircraft on a flight carrying passengers at night unless an instrument rating is included in his licence or he has within the immediately preceding ninety days carried out as pilot in command not less the five take-offs and five landings at a time when the depression of the centre of the sun is not less than twelve degrees below the horizon;

- (ii) co-pilot of any flying machine to a type specified in Part 1 or of such aircraft rating when the flying machine is engaged in a flight for the purpose of public transport or aerial work.

Airline Transport Pilot's Licence (flying machines) Minimum age - 21 years. Maximum period of validity - six months

Privileges: In addition to the privileges given above for the Private Pilot's Licence, the holder of the licence shall be entitled to fly as-

(i) pilot in command of any flying machine of a type specified in Part 1 of the aircraft rating included in the licence when the flying machine is engaged in a flight for the purpose of public transport or aerial work:

Provided that-

- (a) he shall not, unless his licence includes an instrument rating, fly such an aircraft on any scheduled journey;
- (b) he shall not fly such an aircraft on a flight carrying passengers at night unless an instrument rating is included in his licence or he has within the immediately preceding ninety days carried out as pilot in command not less than five take-offs and five landings at a time when the depression of the centre of the sun is not less than twelve degrees below the horizon;

(ii) co-pilot of any flying machine of a type specified in Part 1 or of such aircraft rating when the flying machine is engaged in a flight for the purpose of public transport or aerial work.

In respect of the privileges of a Private Pilot's Licence the maximum period of validity shall be as given for that licence.

### **3. Balloon and airships pilots**

Private Pilot's Licence (balloons and airships), Minimum age - seventeen years. Maximum period of validity-

- (a) 24 months, if the holder is less than forty years of age on the date on which the licence is granted or renewed; or
- (b) twelve months, if the holder is forty years of age or more on that date.

Privileges: The holder of the licence shall be entitled to fly, when the balloon or airship is flying for any purpose other than public transport or aerial work, as-

(i) pilot in command of any type of balloon or airship specified in Part 1 of the aircraft type rating included in the licence;

(ii) co-pilot of any type of balloon or airship specified in Part 1 or Part 2 of such aircraft rating.

Commercial Pilot's Licence (balloons), Minimum age - eighteen years.

Maximum period of validity - six months.

Privileges: In addition to the privileges given above for the Private Pilot's Licence in respect of balloons, the holder of the licence shall be entitled to fly as pilot in command or co-pilot of any type of balloon specified in the aircraft rating included in the licence.

In respect of the privileges given above for the Private Pilot's Licence the maximum period of validity shall be as given for that licence.

Commercial Pilot's Licence (airships), Minimum age - eighteen years. Maximum period of validity - six months.

Privileges: In addition to the privileges given above for the Private Pilot's Licence in respect of airships, the holder of the licence shall be entitled to fly as-

(i) pilot in command of any airship of a type specified in Part 1 of the aircraft rating included in the licence;

(ii) co-pilot of any airship of a type specified in Part 1 or Part 2 or such aircraft rating.

In respect of the privileges of a Private Pilot's Licence the maximum period of validity shall be as given for that licence.

#### **4. Glider pilots**

Commercial Pilot's Licence (gliders)

Minimum age - eighteen years.

Maximum period of validity - six months.

Privileges: The holder of the licence shall be entitled to fly as pilot in command or co-pilot of-

(a) any glider of which the maximum total weight authorised does not exceed 1,500 lb.;

(b) any glider of which the maximum total weight authorised exceeds 1,500 lb. and which is of a type specified in the rating included in the licence.

#### **5. Other flight crew**

Flight Navigator's Licence Minimum age - 21 years.

Maximum period of validity - twelve months.

Privileges: The holder of the licence shall be entitled to act as flight navigator in any aircraft.

Flight Engineer's Licence

Minimum age - 21 years.

Maximum period of validity - twelve months.

Privileges: The holder of the licence shall be entitled to act as flight engineer in any type of aircraft specified in the aircraft rating included in the licence.

Flight Radio-Telephony Operator's General Licence Minimum age - eighteen years.

Maximum period of validity - 24 months.

Privileges: The holder of the licence shall be entitled to operate radio-telephony apparatus in any aircraft.

Flight Radio-Telephony Operator's Restricted Licence

Minimum age - seventeen years.

Maximum period of validity - 24 months.

Privileges: The holder of the licence shall be entitled to operate radio-telephony apparatus in any aircraft if the stability of the frequency radiated by the transmitter is maintained automatically but shall not be entitled to operate the transmitter, or to adjust its frequency, except by the use of external switching devices.

Flight Radio-telegraphy Operator's Licence

Minimum age - twenty years.

Maximum period of validity - twelve months.

Privileges: The holder of the licence shall be entitled to operate radio-telegraphy and radio-telephony apparatus in any aircraft.

Flight Radio-telegraphy Operator's Temporary Licence

Minimum age – eighteen years.

Maximum period of validity - twelve months.

Privileges: The holder of the licence shall be entitled to operate radio-telegraphy and radio-telephony apparatus in any aircraft under the supervision of a person who is the holder of a Flight Radiotelegraphy Operator's licence.

## PART B-RATINGS

**1.** The following ratings may be included in a pilot's licence (other than a student pilot's licence) granted under Part III of these Regulations, and, subject to the provisions of these Regulations and of the licence, the inclusion of a rating in a licence shall have the consequence respectively specified as follows:

**Aircraft Rating:** The licence shall entitle the holder to act as pilot only of aircraft of the types specified in the aircraft rating and different types of aircraft may be specified in respect of different privileges of a licence.

Instrument rating (flying machines) shall entitle the holder of the licence to act as pilot of a flying machine flying in controlled airspace in accordance with the Instrument Flight Rules:

Provided that the holder shall not be so entitled unless the licence bears a certificate, signed by a person authorised by the Minister for that purpose, indicating that the holder has, within the previous thirteen months, passed an instrument flying test.

Night Rating (Private Pilot's Licence - flying machines) shall entitle the holder of a private pilot's licence to act as pilot in command of a flying machine carrying passengers by night.

Towing Rating (flying machines) shall entitle the holder of the licence to act as pilot of a flying machine while towing a glider in flight for the purpose of public transport or aerial work.

Flying Instructor's Rating shall entitle the holder of the licence to give instruction in flying aircraft of such types as may be specified in the rating for that purpose. The maximum period of validity of a flying instructor's rating shall be twelve months.

Assistant Flying Instructor's Rating shall entitle the holder of the licence to give instruction in flying aircraft of such types as may be specified in the rating for that purpose:

Provided that-

- (a) such instruction shall only be given under the supervision of a person present during the take-off and landing at the aerodrome at which the instruction is to begin and end and holding a pilot's licence endorsed with the flying instructor's rating; and
- (b) an assistant flying instructor's rating shall not entitle the holder of the licence to give directions to the person undergoing the instruction in respect of the performance by that person of-
  - (i) his first solo flight; or
  - (ii) his first solo flight by night; or
  - (iii) his first solo cross-country flight otherwise than by night; or
  - (iv) his first solo cross-country flight by night.

The maximum period of validity of an assistant flying instructor's rating shall be twelve months.

**2.** An aircraft rating may be included in every flight engineer's licence. The licence shall entitle the holder to act as flight engineer only of aircraft of a type specified in the aircraft rating.

**3.** For the purposes of this Schedule-



**"solo flight"** means a flight on which the pilot of the aircraft is not accompanied by a person holding a pilot's licence granted or rendered valid under these Regulations;

**"cross-country flight"** means any flight during the course of which the aircraft is more than three miles from the aerodrome of departure.

---

## TENTH SCHEDULE

### *Public transport - operational requirements*

#### PART A-OPERATIONS MANUAL

Information and instructions relating to the following matters shall be included in the operations manual referred to in paragraph (2) of regulation 21 of these Regulations-

- (i) the number of the crew to be carried in the aircraft, on each stage of any route to be flown, and the respective capacities in which they are to act, and instructions as to the order and circumstances in which command is to be assumed by members of the crew;
- (ii) the respective duties of each member of the crew and the other members of the operating staff;
- (iii) the particulars referred to in paragraph (7) of regulation 45 of these Regulations;
- (iv) such technical particulars concerning the aircraft, its engines and equipment and concerning the performance of the aircraft as may be necessary to enable the flight crew of the aircraft to perform their respective duties;
- (v) the manner in which the quantities of fuel and oil to be carried by the aircraft are to be computed and records of fuel and oil carried and consumed on each stage of the route to be flown are to be maintained; the instructions shall take account of all circumstances likely to be encountered on the flight including the possibility of failure of one or more of the aircraft engines;
- (vi) the manner in which the quantity, if any, of oxygen and oxygen equipment to be carried in the aircraft for the purpose of complying with scale K in the Fifth Schedule to these Regulations, is to be computed;
- (vii) the check system to be followed by the crew of the aircraft prior to and on take-off, on landing and in an emergency, so as to ensure that the operating procedures contained in the operations manual and in the flight manual or performance schedule forming part of the relevant certificate of airworthiness are complied with;
- (viii) the circumstances in which a radio watch is to be maintained;

(ix) the circumstances in which oxygen is to be used by the crew of the aircraft, and by passengers;

(x) communication, navigational aids, aerodromes, local regulations, in-flight procedures, instrument approach and landing procedures and such other information as the operator may deem necessary for the proper conduct of flight operations; the information referred to in this paragraph shall be contained in a route guide which may be in the form of a separate volume;

(xi) the reporting in flight to the notified authorities of meteorological observations;

(xii) the minimum altitudes for safe flight on each stage of the route to be flown and any planned diversion therefrom, such minimum altitudes being not lower than any which may be applicable under the laws of Nigeria or of the countries whose territory is to be flown over;

(xiii) such matters as are specified in the Twelfth Schedule to these Regulations relating to weather conditions for take-off and landing;

(xiv) emergency flight procedures, including procedures for the instruction of passengers in the position and use of emergency equipment, and procedures to be adopted when the commander of the aircraft becomes aware that another aircraft or a vessel is in distress and needs assistance:

Provided that in relation to any flight which is not one of a series of flights between the same two places it shall be sufficient if, to the extent that it is not practicable to comply with paragraphs (x), (xii) and (xiii) of this Schedule the manual contains such information and instructions as will enable the equivalent data to be ascertained before take-off.

#### PART B-CREW TRAINING AND TESTS

**1.** The training, experience, practice and periodical tests required under paragraph (2) of regulation 22 of these Regulations in the case of members of the crew of an aircraft engaged on a flight for the purpose of public transport shall be as follows-

*(1) The crew*

Every member of the crew shall-

(a) have been tested within the relevant period by or on behalf of the operator as to his knowledge of the use of the emergency and life-saving equipment required to be carried in the aircraft on the flight; and

(b) have practised within the relevant period under the supervision of the operator or of a person appointed by him for the purpose of carrying out of the duties required of him in case of an emergency occurring to the aircraft, either in an aircraft of the type to be used on the flight or in apparatus approved by the Minister for the purpose and controlled by persons so approved.

## *(2) Pilots*

(a) Every pilot included in the flight crew who is intended by the operator to fly as pilot in conditions requiring compliance with Instrument Flight Rules (which conditions are in this Schedule referred to as "IMC") shall within the relevant period have been tested by or on behalf of the operator as to his competence to perform his duties in an aircraft of the type to be used on the flight, including a test of his ability-

(i) to execute normal and emergency manoeuvres and procedures in flight in such aircraft in IMC, actual or simulated; and

(ii) to use in IMC, actual or simulated, the instruments and equipment provided for use in such conditions in the aircraft to be used on the flight.

(b) A pilot's ability to carry out normal manoeuvres and procedures shall be tested in the aircraft in flight. The other tests required by this sub-paragraph may be conducted either in the aircraft in flight, or under the supervision of a person approved by the Minister for the purpose by means of apparatus so approved in which flight conditions are simulated on the ground.

(c) Every pilot included in the flight crew whose licence does not include an instrument rating or who, notwithstanding the inclusion of such a rating in his licence, is not intended by the operator to fly as pilot in IMC, shall within the relevant period have been tested, by or on behalf of the operator, in flight in an aircraft of the type to be used on the flight as to his competence to act as pilot thereof, including a test of his ability to execute normal and emergency manoeuvres and procedures.

## *(3) Flight engineers*

Every flight engineer included in the flight crew shall within the relevant period have been tested by or on behalf of the operator, either in flight, or, under the supervision of a person approved by the Minister for the purpose, by means of apparatus so approved in which flight conditions are simulated on the ground, as to his competence to perform the duties of flight engineer in aircraft of the type to be used on the flight, including his ability to execute emergency procedures in the course of such duties.

## *(4) Flight navigators and flight radio operators*

Every flight navigator and flight radio operator whose inclusion in the flight crew is required under paragraphs (4) and (5) respectively of regulation 14 of these Regulations shall within the relevant period have been tested by or on behalf of the operator as to his competence to perform his duties in conditions corresponding to those likely to be encountered on the flight-

(a) in the case of a flight navigator, using equipment of the type to be used in the aircraft on the flight for purposes of navigation;

(b) in the case of a flight radio operator, using radio equipment of the type installed in the aircraft to be used on the flight and including a test of his ability to carry out emergency procedures.

*(5) Aircraft commanders*

(a) The pilot designated as commander of the aircraft for the flight shall within the relevant period-

(i) have demonstrated to the satisfaction of the operator that he has adequate knowledge of the route to be taken, the aerodromes of take-off and landing, and any alternate aerodromes, including in particular his knowledge of-

the terrain, the seasonal meteorological conditions, the meteorological, communications, and air traffic facilities, services and procedures, the search and rescue procedures, and the navigational facilities relevant to the route;

(ii) have been tested as to his proficiency in using instrument approach-to-land systems of the type in use at the aerodrome of intended landing and any alternate aerodromes, such test being carried out either in flight in IMC or IMC simulated by means approved by the Minister, or under the supervision of a person approved by the Minister for the purpose by means of apparatus so approved in which flight conditions are simulated on the ground;

(iii) have carried out as pilot in command not less than three take-offs and three landings in aircraft of the type to be used on the flight.

(b) In determining whether a pilot's knowledge of the matters referred to in sub-paragraphs (a) (i) is sufficient to render him competent to perform the duties of aircraft commander on the flight the operator shall take into account the pilot's flying experience in conjunction with the following-

(i) the experience of other members of the intended flight crew;

(ii) the influence of terrain and obstructions on departure and approach procedures at the aerodromes of take-off and intended landing and at alternate aerodromes;

(iii) the similarity of the instrument approach procedures and let-down aids to those with which the pilot is familiar;

(iv) the dimensions of runways which may be used in the course of the flight in relation to the performance limits of aircraft of the type to be used on the flight;

(v) the reliability of meteorological forecasts and the probability of difficult meteorological conditions in the areas to be traversed;

(vi) the nature of air traffic control procedures and familiarity of the pilot with such procedures;

(vii) the influence of terrain on route conditions and the extent of the assistance obtainable on route from navigational aids and air-to-ground communication facilities;

(viii) the extent to which it is possible for the pilot to become familiar with unusual aerodrome procedures and features of the route by means of ground instruction and training devices.

(6) For the purposes of this Schedule, the expression "**relevant period**" means a period which immediately precedes the commencements of the flight, being a period-

(a) in the case of sub-paragraph (5) (a) (iii) of this paragraph, of three months;

(b) in the case of sub-paragraphs (2), (3) and (5) (a) (ii) of this paragraph, of six months;

(c) in the case of sub-paragraphs (1), (4) and (5) (a) (i) of this paragraph, of twelve months:

Provided that-

(i) any pilot of the aircraft to whom the provisions of sub-paragraph (2) or (5) (a) (ii) and any flight engineer of the aircraft to whom the provisions of sub-paragraph (3) of this paragraph apply shall for the purposes of the flight be deemed to have complied with such requirements respectively within the relevant period if he has qualified to perform his duties in accordance therewith on two occasions within the period of twelve months immediately preceding the flight, such occasions being separated by an interval of not less than four months;

(ii) the requirements of sub-paragraph (5) (a) (i) shall be deemed to have been complied with within the relevant period by a pilot designated as commander of the aircraft for the flight if, having become qualified so as to act on flights between the same places over the same route more than twelve months before commencement of the flight, he has within the period of twelve months immediately preceding the flight flown as pilot of an aircraft between those places over that route.

7. (1) The records required to be maintained by an operator under paragraph (2) of regulation 22 of these Regulations shall be accurate and up to date records so kept as to show, on any date, in relation to each person who has during the period of two years immediately preceding that date flown as a member of the crew of any public transport aircraft operated by that operator-

(a) the date and particulars of each test required by this Schedule undergone by that person during the said period including the name and qualifications of the examiner;

(b) the date upon which that person last practised the carrying out of the duties referred to in paragraph 1 (1) (b) of this Schedule;

(c) the operator's conclusions based on each such test and practice as to that person's competence to perform his duties;

(d) the date and particulars of any decision taken by the operator during the said period in pursuance of paragraph 1 (5) (a) (i) of this Schedule including particulars of the evidence upon which that decision was based.

(2) The operator shall whenever called upon to do so by any authorised person produce for the inspection of any person so authorised all records referred to in the preceding sub-paragraph and furnish to any such person all such information as he may require in connection with any such records

and produce for his inspection all log books, certificates, papers and other documents whatsoever which he may reasonably require to see for the purpose of determining whether such records are complete or of verifying the accuracy of their contents.

(3) The operator shall at the request of any person in respect of whom he is required to keep records as aforesaid furnish to that person, or to any operator of aircraft for the purpose of public transport by whom that person may subsequently be employed, particulars of any qualifications in accordance with this Schedule obtained by such person whilst in his service.

Documents to be carried by aircraft registered in Nigeria.

On a flight for the purpose of public transport-

Documents A, B, C, D, E, F, and if the flight is international air navigation, document G.

On a flight for the purpose of aerial work-

Documents A, B, C, E, F, and if the flight is international air navigation document G.

On a flight, being international air navigation, for a purpose other than public transport or aerial work, documents A, B, C, and G.

For the purposes of this Schedule-

"A" means any licence to install and operate radio apparatus in the aircraft for the time being in force, and the current telecommunication log book required by these Regulations;

"B" means the certificate of airworthiness in force in respect of the aircraft;

"C" means the licences of the members of the flight crew of the aircraft;

"D" means one copy of the load sheet, if any, required by regulation 23 of these Regulations in respect of the flight;

"E" means one copy of each certificate of maintenance, if any, in force in respect of the aircraft;

"F" means the technical log if any, in which entries are required to be made under paragraph (5) of regulation 6 of these Regulations;

"G" means the certificate of registration in force in respect of the aircraft.

For the purposes of this Schedule-

**"international air navigation"** means any flight in which a landing is made outside the State in which the aircraft commences the flight.

---

## TWELFTH SCHEDULE

*Minimum weather conditions for take-off, approach to landing and landing by public transport aircraft registered in Nigeria*

(1) In this Schedule-

**"approach to landing"** means that portion of the flight of the aircraft in which it is descending below a height of 1,000 feet above the critical height of the relevant minimum for landing;

**"cloud ceiling"**, in relation to an aerodrome, means the vertical distance from the elevation of the aerodrome to the lowest part of any cloud visible from the aerodrome which is sufficient to obscure more than one half of the sky so visible;

**"critical height"** means the minimum height above the elevation of the aerodrome to which an approach to landing can safely be continued without visual reference to the ground;

**"minimum weather conditions"**, in relation to an aerodrome, means the cloud ceiling and runway visual range for take-off and the critical height and runway visual range for landing below which the aircraft cannot safely take off or land (as the case may be) at that aerodrome, and the expression "relevant minimum" shall be construed accordingly;

**"runway visual range"**, in relation to a runway or landing strip, means the maximum distance in the direction of take-off or landing, as the case may be, at which the runway or landing strip or the markers or lights delineating it can be seen from a point fifteen feet above its centre line; and in the case of an aerodrome in Nigeria the distance, if any, communicated to the commander of the aircraft by or on behalf of the person in charge of the aerodrome as being the runway visual range, shall be taken to be the runway visual range for the time being;

**"specified"**, in relation to an aircraft, means specified in or ascertainable by reference to the operations manual relating to that aircraft.

(2) In compliance with regulation 21 (2) of these Regulations and paragraph (xiii) of Part A of the Tenth Schedule hereto the operator of every aircraft to which that regulation applies shall establish and include in the operations manual relating to the aircraft particulars of minimum weather conditions appropriate to every aerodrome of intended departure or landing and every alternate aerodrome:

Provided that, in respect of aerodromes to be used only on a flight which is not a scheduled journey or any part thereof it shall be sufficient to include in the operations manual data and instructions by means of which the appropriate minimum weather conditions can be calculated by the commander of the aircraft.

(3) The minimum weather conditions specified shall not, in respect of any aerodrome, be less favourable than any declared in respect of that aerodrome by the competent authority, unless that authority otherwise permits in writing.

(4) In establishing minimum weather conditions for the purpose of this regulation, the operator of the aircraft shall take into account the following matters-

(a) the type and performance and handling characteristics of the aircraft and any relevant conditions in its certificate of airworthiness;

(b) the composition of its crew;

(c) the physical characteristics of the relevant aerodrome and its surroundings;

(d) the dimensions of the runways which may be selected for use;

(e) whether or not there are in use at the relevant aerodrome any aids, visual or otherwise, to assist aircraft in approach, landing, or take-off, being aids which the crew of the aircraft are trained and equipped to use; the nature of any such aids that are in use; and the procedures for approach, landing and take-off which may be adopted according to the existence or absence of such aids; and shall establish in relation to each runway which may be selected for use minimum weather conditions appropriate to each set of circumstances which can reasonably be expected.

(5) With reference to regulation 24 (3) of these Regulations an aircraft shall not commence a flight at a time when-

(a) the cloud ceiling or the runway visual range at the aerodrome of departure is less than the minimum respectively specified for take-off; or

(b) according to the information available to the commander of the aircraft it would not be able, without contravening paragraph (6) of this Schedule to commence or continue an approach to landing at the aerodrome of intended destination at the estimated time of arrival there and at any alternate aerodrome at any time at which according to a reasonable estimate the aircraft would arrive there.

(6) With reference to regulation 24 (3) of these Regulations, an aircraft shall not-

(a) commence or continue an approach to landing at any aerodrome if the runway visual range at that aerodrome, established or determined as aforesaid, is at the time less than the relevant minimum for landing; or

(b) continue an approach to landing at any aerodrome by flying below the critical height of the relevant minimum for landing if from that height the approach to landing cannot be completed entirely by visual reference to the ground.

(7) If, according to the information available, an aircraft would as regards any flight be required by the Rules of the Air and Air Traffic Control to be flown in accordance with the Instrument Flight Rules at the aerodrome of intended landing, the commander of the aircraft shall select prior to take-off an alternate aerodrome unless no aerodrome suitable for that purpose is available.

---



THIRTEENTH SCHEDULE

Lagos Sokoto Maiduguri

Kano Calabar

---

FOURTEENTH SCHEDULE

*Aerodrome permit*

*Regulation 75 (2) of the Civil Aviation (Air Navigation) Regulations*

Holder's Name

Rank

Address

The holder of this Aerodrome Permit is a person authorised to have free access to all parts of any Government or licensed aerodrome in Nigeria, including all parts of any building on such aerodrome.

DATED at.....this.....day of.....20.....

Photograph  
of  
holder

.....

Minister of Aviation

*Note:* This Aerodrome Permit does not give the holder the right to enter any customs bonded warehouse.

Signature of holder.....

---

FIFTEENTH SCHEDULE

*Penalties*

PART A-PROVISIONS REFERRED TO IN PARAGRAPH (5) OF REGULATION 79

- |                               |                                      |
|-------------------------------|--------------------------------------|
| Regulation 1                  | Regulation 29 (except paragraph (2)) |
| Regulation 3                  | Paragraph (1) of regulation 39       |
| Paragraph (5) of regulation 7 | Paragraph (1) of regulation 40       |

Regulation 11	Regulation 48
Paragraph (3) of regulation 12	Regulation 53
Regulation 18	Paragraph (2) of regulation 57
Regulation 20	Paragraph (3) of regulation 61
Regulation 21	Regulation 67
Paragraph (5) of regulation 23	Paragraph (1) of regulation 72

PART B-PROVISIONS REFERRED TO IN PARAGRAPH (6) OF REGULATION 79

Regulation 4	Paragraph (2) of regulation 40
Paragraph (1) of regulation 6	Regulation 41
Regulation 7 (except paragraph (5))	Regulation 42
Regulation 9	Regulations 44 to 47 inclusive
Regulation 10	Regulation 49
Regulation 12 (except paragraph (3))	Regulation 55 (except paragraph (3))
Regulation 14	Regulation 56 (except paragraph (4))
Regulation 15	Regulation 57 (except paragraph (2))
Regulation 19	Regulation 58
Regulation 22	Regulation 63
Regulation 23 (except paragraph (5))	Paragraph (2) of regulation 61
Regulations 24 to 28 inclusive	Regulation 69
Paragraph (2) of regulation 29	Regulation 71
Regulations 30 to 38 inclusive	Regulation 73
Paragraph (2) of regulation 39	Regulation 77

---