



OFFICE FOR HARMONIZATION
IN THE INTERNAL MARKET
(TRADE MARKS AND DESIGNS)

The President

**DECISION No EX-15-7 OF THE PRESIDENT OF THE OFFICE
of 11 December 2015**

**adopting the Guidelines for Examination in the Office for Harmonization in the
Internal Market (Trade Marks and Designs) on Community Trade Marks and on
Registered Community Designs**

THE PRESIDENT OF THE OFFICE FOR HARMONIZATION IN THE INTERNAL
MARKET (TRADE MARKS AND DESIGNS),

Having regard to Council Regulation (EC) No 207/2009 of 26 February 2009 on the
Community trade mark ("CTMR"), in particular Article 124 (2) (a) thereof, and to
Council Regulation (EC) No 6/2002 of 12 December 2001 on Community designs
("CDR"), in particular Article 100 thereof,

After consultation of the Administrative Board in accordance with Article 126 (4) CTMR
and Article 101 (b) CDR,

HAS ADOPTED THE FOLLOWING DECISION:

Article 1

The following Guidelines for Examination in the Office for Harmonization in the Internal
Market (Trade Marks and Designs) on Community Trade Marks and on Registered
Community Designs which are annexed to this Decision are hereby adopted:

New Parts of the Guidelines:

A) COMMUNITY TRADE MARK:

Part A: General Rules

Section 3, Payment of fees, costs and charges

Section 5, Professional representation

Part B: Examination

Section 2, Examination of Formalities

Section 4, Absolute Grounds for Refusal 7(1)(a), (b), (c), (d), (e) and 7(3)

Part C: Opposition

Section 0, Introduction

Section 1, Procedural Matters

Section 2, Double Identity and Likelihood of confusion

Chapter 1, General Principles

Chapter 2, Comparison of Goods and Services

Chapter 3, Relevant public and degree of attention

Chapter 4, Comparison of Signs

Chapter 5, Distinctiveness of the earlier mark
Chapter 6, Other factors
Chapter 7, Global assessment

Section 6, Proof of Use

Part D: Cancellation
Section 1, Cancellation proceedings

Part E: Register Operations
Section 2, Conversion
Section 4, Renewal
Section 5, Inspection of files
Section 6, Other entries in the Register
Chapter 1, Counterclaims

B) REGISTERED COMMUNITY DESIGN:

Examination of Design Invalidation Applications

Article 2

The Office Practice contained in the previous Guidelines on Trade Mark Practice and on Designs Practice and to the extent as it corresponds to the Parts as referred to in Article 1 is hereby repealed.

Article 3

The Guidelines referred to in Article 1 shall be published in the Official Journal of the Office.

Article 4

This Decision shall be published in the Official Journal of the Office and enter into force on the 01/02/2016.

Done at Alicante, 11 December 2015



António Campinos
President

***GUIDELINES FOR EXAMINATION IN THE
OFFICE FOR HARMONIZATION IN THE
INTERNAL MARKET (TRADE MARKS AND
DESIGNS)***

***EDITOR'S NOTE AND GENERAL
INTRODUCTION***

Table of Contents

1	Subject Matter	3
2	Objective of the Guidelines	3
3	Guidelines Revision Process	4
4	Structure of the Guidelines.....	5

1 Subject Matter

Council Regulation No 40/94 of 20 December 1993, as amended and codified in Council Regulation No 207/09 of 26 February 2009 (CTMR), established, in parallel with the national systems, a Community trade mark system with the aim of eliminating one of the main obstacles to the development of the single European market. Council Regulation No 6/02 of 12 December 2001 (CDR) did the same for Community designs. Hitherto, the law governing the registration and use of trade marks or designs had been exclusively national and made it difficult for the same trade mark or design to be used throughout the European Union.

The Office for Harmonization in the Internal Market (Trade Marks and Designs) (OHIM or the Office), established in Alicante, is responsible for the registration of Community Trade Marks (CTM) and Registered Community Designs (RCD). These registrations provide uniform trade mark and design protection throughout the European Union.

The Office deals with registration procedures (including the examination of applications for absolute grounds for refusal and, where an opposition has been raised regarding a CTM application, for relative grounds for refusal), maintains the public registers of these rights and decides on applications for those rights, once registered, to be declared invalid. The Office's Guidelines cover practice in all these areas.

2 Objective of the Guidelines

The purpose of the Guidelines on CTMs and the Guidelines on RCDs is to improve the coherence, predictability and quality of the Office's decisions. The Guidelines are designed to bring together, systematically, the principles of practice derived from the jurisprudence of the European Court of Justice, the case-law of the Office's Boards of Appeal, the decisions of the Office's Operations Department and the outcome of the Office's Convergence Programmes with EU IP offices. They provide a unique source of reference on Office practice with regard to CTMs and RCDs and are intended to be of practical use both to Office staff in charge of the various procedures and to users of the Office's services.

The Guidelines have been drawn up to reflect Office practice in the most frequent scenarios. They contain only general instructions, which have to be adapted to the particularities of a case. They are not legislative texts and, therefore, are not of a binding nature. Both the parties involved and the Office must, where necessary, refer to the CTMR, the CDR, and their respective Implementing Regulations, the Fee Regulations, Commission Regulation (EC) No 216/96 of 05/02/1996 laying down the rules of procedure of the Boards of Appeal and, finally, the interpretation of these texts handed down by the Boards of Appeal and the Court of Justice of the European Union, including the General Court of the European Union.

As case-law is evolving constantly, the Guidelines will also evolve. They will be adapted to reflect developments in Office practice on a yearly basis by means of an ongoing revision exercise (see point 3 below).

3 Guidelines Revision Process

As the sole source of reference on Office practice with regard to CTMs and RCDs, the Guidelines are available in all official EU languages. They are revised by the cross-departmental Knowledge Circles of the Office in a cyclical and open process: 'cyclical' because practice is updated on a yearly basis by looking at the case-law of the preceding year and taking into account operational needs and the outcome of convergence initiatives, and 'open' because external stakeholders are involved in defining that practice.

The involvement of national offices and user associations not only benefits the quality of the Guidelines, but is also expected to facilitate convergence, that is, the process of exploring common ground on issues where there are diverging practices. Making the Guidelines available in all EU languages will raise awareness of Office practice amongst Member States and users and make differences in practice easier to identify.

The yearly work is split into two 'work packages': Work Package 1 (WP1) runs over a twelve-month period each year from January to December, and Work Package 2 (WP2) over a twelve-month period each year from July to June.

The process involves the following phases:

a. Initiation of update by stakeholders

Having been made aware of the Office's revision plans, in particular what is to be revised and when, the national offices and user associations are welcome to submit comments before January (for WP1) and before July (for WP2). Comments not received on time will be taken into consideration during the next cycle or may be submitted during phase c.

b. Preparation of the draft Guidelines by the Office

During this phase, the draft Guidelines are produced by the Office's Knowledge Circles. The process starts each year in January (for WP1) and July (for WP2). Feedback and comments submitted in advance from users are taken into consideration. The three steps of the process – analysis, drafting and discussion – must be completed in a timely manner. Analysis involves the Knowledge Circles extracting trends from the preceding year's case-law, studying the conclusions of the convergence projects and taking into consideration the comments received from the Office's users and internal stakeholders. As the next step, the Knowledge Circles draft the guidelines. Finally, the texts are discussed amongst the various units and departments of the Office.

c. Adoption of the Guidelines

In the last phase, the draft Guidelines are sent for translation into the Office languages. The texts and translations are circulated amongst the user associations and the EU IP offices with a view to receiving feedback before the next meeting of the Office's Administrative Board (AB). After consulting the AB in accordance with Article 126(4) CTMR and Article 101(b) CDR, the President adopts the updated Guidelines. The versions in the five Office languages together make up the official text, which is intended to be published in January (WP1) and July (WP2) of each year, respectively. In the event of discrepancies

between different language versions, the text in the drafting language (English) will prevail. Once adopted, the Guidelines will be translated into the remaining official languages of the European Union as a matter of courtesy and for transparency. These additional translations will be published on the Office's website, and external stakeholders, whether national offices or user associations, will be free to submit feedback on their quality; any linguistic amendments made as a result of this informal feedback will be incorporated into the texts without any formal procedure.

d. Fast-track procedure

Where a major external event has an immediate impact on Office practice (for example, certain judgments of the Court of Justice), the Office can amend the Guidelines in a fast-track procedure outside the normal time frame set out above. However, this procedure is the exception to the norm. As the process is cyclical, such changes will always be open to comments and revision in the following cycle.

4 Structure of the Guidelines

The items dealt with in WP1 and WP2, respectively, are set out below. In exceptional circumstances, certain elements of practice might be changed from one WP to another. Should such a change occur, it will be communicated to stakeholders.

COMMUNITY TRADE MARK:

WP1

Part A: General Rules

Section 3, Payment of fees, costs and charges
Section 5, Professional representation

Part B: Examination

Section 2, Formalities
Section 4, Absolute Grounds for Refusal 7(1)(a)
Section 4, Absolute Grounds for Refusal 7(1)(b)
Section 4, Absolute Grounds for Refusal 7(1)(c)
Section 4, Absolute Grounds for Refusal 7(1)(d)
Section 4, Absolute Grounds for Refusal 7(1)(e)
Section 4, Absolute Grounds for Refusal 7(3)

WP2

Part A: General Rules

Section 1, Means of communication, time limits
Section 2, General principles to be respected in proceedings
Section 4, Language of proceedings
Section 6, Revocation of decisions, cancellation of entries in the Register and correction of errors
Section 7, Revision
Section 8, Restitutio in Integrum
Section 9, Enlargement

Part B: Examination

Section 1, Proceedings
Section 3, Classification
Section 4, Absolute Grounds for Refusal 7(1)(f)
Section 4, Absolute Grounds for Refusal 7(1)(g)
Section 4, Absolute Grounds for Refusal 7(1)(h)+(i)
Section 4, Absolute Grounds for Refusal 7(1)(j)+(k)
Section 4, Collective marks

Part C: Opposition

Section 0, Introduction

Section 1, Procedural Matters

Section 2, Double identity and Likelihood of confusion

Chapter 1, General Principles

Chapter 2, Comparison of Goods and Services

Chapter 3, Relevant public and degree of attention

Chapter 4, Comparison of signs

Chapter 5, Distinctiveness of the earlier mark

Chapter 6, Other factors

Chapter 7, Global assessment

Section 6, Proof of Use

Part D: Cancellation

Section 1, Cancellation proceedings

Part E: Register Operations

Section 2, Conversion

Section 4, Renewal

Section 5, Inspection of files

Section 6, Other entries in the Register

Chapter 1, Counterclaims

REGISTERED COMMUNITY DESIGN

WP1

Examination of Design Invalidation Applications

Part C: Opposition

Section 3, Unauthorised filing by agents of the TM proprietor (Article 8(3) CTMR)

Section 4, Rights under Article 8(4) CTMR

Section 5, Trade marks with reputation Article 8 (5) CTMR

Part D: Cancellation

Section 2, Substantive provisions

Part E: Register Operations

Section 1, Changes in a registration

Section 3, CTMs as objects of property

Chapter 1, Transfer

Chapter 2, Licences

Chapter 3, Rights in rem

Chapter 4, Levy of execution

Chapter 5, Insolvency proceedings or similar proceedings

Part M: International marks

WP2

Examination of Applications for Registered Community Designs

Renewal of Registered Community Designs

***GUIDELINES FOR EXAMINATION IN THE
OFFICE FOR HARMONIZATION IN THE
INTERNAL MARKET (TRADE MARKS AND
DESIGNS) ON COMMUNITY TRADE MARKS***

PART A

GENERAL RULES

SECTION 3

PAYMENT OF FEES, COSTS AND CHARGES

Table of Contents

1	Introduction.....	3
2	Means of Payment	4
	2.1 Payment by bank transfer.....	4
	2.1.1 Bank account.....	4
	2.1.2 Details that must accompany the payment	5
	2.2 Payment by debit or credit card	7
	2.3 Payment by the Office current account	7
3	Time of Payment.....	9
4	Date on which Payment is Deemed to be Made.....	9
	4.1 Payment by bank transfer.....	9
	4.1.1 Late payment with or without surcharge.....	9
	4.1.2 Evidence of payment and of the date of payment.....	10
	4.2 Payment by debit or credit card	11
	4.3 Payment by current account	11
5	Refund of Fees.....	12
	5.1 Refund of application fee.....	12
	5.2 Refund of the opposition fee	13
	5.3 Refund of fees for international marks designating the EU	13
	5.4 Refund of appeal fees	13
	5.5 Refund of renewal fees	13
	5.6 Refund of insignificant amounts	14
6	Fee Reduction for the CTM Application Filed by Electronic Means....	14
7	Decisions on Costs	15
	7.1 Apportionment of costs	15
	7.2 Fixing of costs	15
	7.3. Enforcement of the decision on costs	15
	7.3.1 Conditions.....	15
	7.3.2 National authority.....	16
	7.3.3 Proceedings.....	16

1 Introduction

Article 2 CTMFR

For CTMs, in addition to the provisions contained in the basic CTMR and in the CTMIR, there is a specific regulation on the fees payable to the Office (CTMFR). This regulation was amended once in 2004, twice in 2005 and once in 2009. An unofficial consolidated text of the CTMFR, including references to the codified CTMR, is available online. The full list of fees can be found on the Office website.

Similarly, for RCDs, in addition to the provisions contained in the basic CDR and in the CDIR, there is a specific regulation on the fees payable to the Office (CDFR). This regulation was amended in 2007 following the accession of the European Union to the Geneva Act of the Hague Agreement concerning the international registration of industrial designs.

Finally, the President of the Office is empowered to lay down charges that may be payable to the Office for services it may render and to authorise methods of payments in addition to those explicitly provided for in the CTMFR and the CDFR.

The differences between fees, costs and charges are as follows.

- Fees must be paid to the Office by users for the filing and handling of trade marks and designs proceedings; the fees regulations determine the amounts of the fees and the ways in which they must be paid. Most of the proceedings before the Office are subject to the payment of fees, such as the application fee for a CTM or an RCD, a renewal fee, etc. Some fees have been reduced to zero (e.g. registration fees for CTMs, transfers for CTMs).

The amounts of the fees have to be fixed at such a level as to ensure that the revenue is in principle sufficient for the budget of the Office to be balanced (see Article 144 CTMR), in order to guarantee the full autonomy and independence of the Office. The revenue of the Office comes principally from fees paid by the users of the system (see recital 18 CTMR).

- Costs refer to the costs of the parties in *inter partes* proceedings before the Office in particular for professional representation (for trade marks see Article 85 CTMR and Rule 94 CTMIR, for designs see Articles 70-71 CDR and Article 79 CDIR). Decisions in *inter partes* cases must contain a decision on fees and costs of the professional representatives and must fix the amount. The decision on costs may be enforced once the decision has become final, pursuant to Article 86 CTMR.
- Charges are fixed by the President of the Office for any services rendered by the Office other than those specified in Article 2 CTMFR (see Rule 87(2) CTMIR and Article 3(1) and (2) CTMFR). The amounts of the charges laid down by the President will be published in the Official Journal of the Office and can be found on the website under decisions of the President. Examples are the charges for mediation in Brussels or for certain publications issued by the Office.

2 Means of Payment

Article 5 CTMFR
 Article 5 CDFR
 Communication No 2/97 of the President of the Office of 03/07/1997

All fees and charges must be paid in euros. Payments in other currencies are not valid, do not create rights and will be reimbursed.

Fees payable to the Office may not be paid to or via national offices.

The admissible means of payment are, in most cases, bank transfers, debits from the current accounts held at the Office, and (for certain online services only) debit or credit cards. Cash payments at the Office's premises and cheques are no longer accepted (decision of 03/09/2008, R 0524/2008-1, TEAMSTAR).

The Office cannot issue invoices. However, the Office will provide a receipt when requested to do so by the user.

2.1 Payment by bank transfer

Money may be sent to the Office by means of transfer. A fee is not deemed to be paid if the order to transfer is given after the end of the time limit. If the fee is sent before the time limit but arrives after its expiry, under specific conditions the Office may consider the fee has been duly paid (see paragraph 4.1 below).

2.1.1 Bank account

Payment by bank transfer can only be made to one of the following two bank accounts of the Office:

Bank	Banco Bilbao Vizcaya Argentaria	La Caixa
Address	Explanada de España, 11 E-03002 Alicante SPAIN	Calle Capitán Segarra, 6 E-03004 Alicante SPAIN
Swift code*	BBVAESMMXXX	CAIXESBBXX
IBAN	ES8801825596900092222222	ES0321002353010700000888
Bank charges**	>OUR	>OUR

* **Swift code:** Some computer programs do not accept the last three digits XXX of the Swift/BIC code. Should this be the case, users must indicate BBVAESMM or CAIXESBB.

** **Bank charges:** It is important to make sure that the entire amount reaches the Office, without any deductions. Therefore, in the case of a transfer 'OUR' must be indicated as the method of payment for the bank charges in order to allow full reception by the Office of the amount due. However, for SEPA payments, the default SEPA specification 'SHA' is required. SEPA is a common European payments system, used by most banks in all EU Member States and five additional European countries.

2.1.2 Details that must accompany the payment

Article 7 CTMFR Article 6 CDFR

The payment of a fee and indication of the nature of the fee and the procedure to which it refers does not substitute the other remaining formal requirements of the procedural act concerned. For example, the payment of the appeal fee and the indication of the number of the contested decision is not sufficient for filing a valid notice of appeal (judgments of 31/05/2005, T-373/03, Parmitalia, EU:T:2005:191, § 58; 09/09/2010, T-70/08, Etrax, EU:T:2010:375, § 23-25).

When the information supplied is insufficient to properly enable the allocation of the payment, the Office will specify a time limit within which the missing information must be provided, failing which the payment will be considered not to have been made and the sum will be reimbursed. The Office receives thousands of payments a day and the incorrect or insufficient identification of the file can lead to considerable delays in processing procedural acts.

The following data must be included in the transfer form with the payment:

- number of the proceeding (e.g. CTM, opposition number, RCD number etc.);
- payer's name and address or Office ID number;
- nature of the fee, preferably in its abbreviated form.

In order to deal with payments swiftly with regards to bank transfers, and bearing in mind that only a limited number of characters may be used in the 'sender' and 'description' fields, filling in these fields as follows is highly recommended.

Description field

- Use the codes listed in the tables below, for example: CTM instead of: 'Application Fee for a Community Trade Mark'.
- Remove initial zeroes in numbers and do not use spaces or dashes since they use up space unnecessarily.
- Always start with the CTM or RCD number, e.g. CTM3558961.
- If the payment is for more than one trade mark or design, only specify the first and last one, e.g. CTM3558961-3558969, and then send a fax with the full details of the trade marks or designs concerned.

Description codes

Description	Code	Example
Payment to current account	CC + account number	CC1361
If the owner or the representative has an ID number	OWN + ID number, REP + ID number	REP10711
Number of the trade mark or the design	CTM, RCD + number	CTM5104422 RCD1698
A short nickname of the CTM or RCD		'XYZABC' or 'bottle shape'
Operation code: Application fee for CTM or RCD International application fee Renewal fee Opposition fee Cancellation fee Appeal Recordal Transfer Conversion Inspection of files Certified Copies	CTM, RCD INT RENEWAL OPP CANC APP REC TRANSF CONV INSP COPIES	OPP, REC, RENEW, INSP, INT, TRANSF, CANC, CONV, COPIES, APP

Examples:

Payment Object	Example of Payment Description
Application fee (CTM = <i>Community Trade Mark</i>)	CTM5104422 XYZABC
Application fee (RCD = <i>Registered Community Design</i>)	RCD1234567 bottle shape
Opposition + payer	CTM4325047 OPP XYZABCREP10711
International application	CTM4325047 INT XYZABC
Renewal (CTM)	CTM509936 RENEWAL
Payment to current account No 1361	CC1361
Certified Copies	CTM1820061 COPIES
Transfer of multiple designs (first 1420061 and last 1420065) + payer	RCD1420061-1420065 TRANSF REP10711
Recordal of a licence for a CTM	CTM4325047 REC LICENCE OWN10711

Sender field

Examples for address

Address	Example
Payer's name Payer's address Payer's city and postcode	John Smith 58 Long Drive London, ED5 6V8

- Use a name that can be identified as a payer, applicant (owner or representative) or opponent.

- For the payer's name, use only the name **without abbreviations**, like DIPL.-ING. PHYS., DR., etc.
- Use the same form of identification for future payments.

2.2 Payment by debit or credit card

Decision No EX-13-2 of the President of the Office of 26/11/2013 concerning electronic communication with and by the Office: Article 7, Electronic payment of fees by credit card
Article 2(1)(b) to Article 2(4) and Article 2(12) to (15) CTMFR and Article 5(2) CDFR

Payment by debit or credit card is not yet available for all of the Office's fees. Only certain online services can be paid by debit or credit card.

For applications and renewals filed electronically, payment by debit or credit card is the recommended method. Debit or credit card payments allow the Office to make the best use of its own automatic internal systems, so that work can start on the file more quickly.

Debit or credit card payments are immediate (see paragraph 4.2 below) and are therefore not allowed for delayed payments (within one month from the filing date).

For all other fees, the use of debit or credit cards is not currently available. In particular, debit or credit cards cannot be used to pay charges referred to in Article 3 CTMFR and Article 3 CDFR or to top up a current account.

Debit or credit card payments require some essential information. The information disclosed will not be stored by the Office in any permanent database. It will only be kept until it is sent to the bank. Any record of the form will only include the debit or credit card type plus the last four digits of the debit or credit card number. The entire debit or credit card number can safely be entered via a secure server, which encrypts all information submitted.

2.3 Payment by the Office current account

Decision No Ex-96-1 of the President of the Office of 11/01/1996 concerning the conditions for opening current accounts at the Office as amended in 1996, 2003 and 2006
Communication No 5/01 of the President of the Office of 29/06/2001 concerning the availability of current accounts statements on the Office internet site
Communication No 11/02 of the President of the Office of 11/10/2002 concerning the opening of another bank account

It is advisable to open a current account at the Office, as for any request that is subject to time limits, such as filing oppositions or appeals, the payment will be deemed to have been made on time even if the relevant documentation for which the payment was made (for instance a notice of opposition) is submitted on the last day of the deadline, provided that the current account has sufficient funds (see paragraph 4.3 below) (decision of 07/09/2012, R 2596/2011-3, 'STAIR GATES', § 13-14). The date on

which the current account is actually debited will usually be later, but payment will be deemed to have been made on the date on which the request for a procedural act is received by the Office, or as otherwise convenient for the party to the proceedings, in accordance with Article 6 of Decision No Ex-96-1 of the President of the Office as amended in 2006.

If the person (either party to the proceedings or their representative) that has filed the application or the respective procedural act is the holder of a current account with the Office, the Office will automatically debit the current account, unless instructions to the contrary are given in any individual case. In order for the account to be correctly identified, the Office recommends clearly indicating the Office ID number of the holder of the current account with the Office.

The system of current accounts is an automatic debiting system, meaning that upon identification of such an account, the Office may debit, according to the development of the procedures concerned and insofar as there are sufficient funds in the account, all fees and charges due within the limits of the aforementioned procedures, and a payment date will be accorded each time without any further instructions. The only exception to this rule is made when the holder of a current account who wishes to exclude the use of their current account for a particular fee or charge informs the Office thereof in writing. In this scenario, however, the owner of the account may change the method of payment back to payment by current account at any time before the expiry of the payment deadline.

The absence of an indication or incorrect indication of the amount of the fee does not have any negative effect, since the current account will be automatically debited with reference to the corresponding procedural act for which the payment is due.

If there are insufficient funds in a current account, the holder will be notified by the Office and given the possibility to replenish the account and to pay 20 % to cover administrative charges due to lack of funds. If the holder does so, the payment of the fee will be deemed to have been received on the date the relevant document in relation to which the payment was made (for instance a notice of opposition) is received by the Office. If payment concerns the replenishment of a current account, it is sufficient to indicate the current account number. If the account is replenished, the holder should ensure that sufficient funds are provided for all payments due or at least indicate the priorities for which the money should be used (decision of 03/09/2008, R 1350/2007-1, SCHNEIDER). Where no priorities are indicated, the Office will cover the payments in the chronological order in which they fall due.

The Office provides current account holders with access to their current account information over a secure internet connection for at least the previous year via its website. The service includes the account balance, a list of all transactions, monthly statements and a search tool to find specific transactions.

Payment of a fee by debiting a current account held by a third party requires an explicit written authorisation. Payment is considered effective on the date the Office receives the authorisation. The authorisation must be given by the holder of the current account and must state that their account can be debited for a specific fee. If the holder is neither the party nor their representative, the Office will check whether there is such an authorisation. If there is not, the Office will invite the party concerned to submit the authorisation to debit the third party's account before the time limit for payment expires, where the Office has reason to doubt the existence of such authorisation. The party

requesting the payment of a fee by debiting a third party's current account must submit the authorisation to the Office in order to allow the account to be debited.

A current account can be opened at the Office by sending a request to the general fax No +34 965 131 344, or email: fee.information@oami.europa.eu.

The minimum amount required to open a current account is EUR 3 000.

3 Time of Payment

Article 4 CTMFR Article 4 CDFR

Fees must be paid on or before the date on which they become due.

If a time limit is specified for a payment to be made, then that payment must be made within that time limit.

Fees and charges for which the regulations do not specify a due date will be due on the date of receipt of the request for the service for which the fee or the charge is incurred, for example, a recordal application.

4 Date on which Payment is Deemed to be Made

Article 8(1) and (3) CTMFR Article 7 CDFR Article 7 of Decision No Ex-96-1 of the President of the Office of 11/01/1996 concerning the conditions for opening current accounts at the Office as amended in 1996, 2003 and 2006 Decision No EX-13-2 of the President of the Office of 26/11/2013 concerning electronic communication with and by the Office, Article 7, Electronic payment of fees by credit card

The date on which a payment is deemed to be made will depend on the method of payment.

4.1 Payment by bank transfer

When the payment is made by transfer or payment to an Office bank account, the date on which payment is deemed to have been made is the date on which the amount is credited to the Office bank account.

4.1.1 Late payment with or without surcharge

A payment that is received by the Office after the expiry of the time limit will be considered to have been made in due time if evidence is submitted to the Office that the person who made the payment, (a) duly gave an order within the relevant period for payment, to a banking establishment to transfer the amount of the payment, and (b)

paid a surcharge of 10 % of the total amount due (up to a maximum amount of EUR 200). (Both conditions must be fulfilled in accordance with judgment of 12/05/2011, T-488/09, Redtube, EU:T:2011:211, § 38, and decision of 10/10/2006, R 0203/2005-1, Blue Cross).

The same is not true for the late payment of the surcharge. If the surcharge is late, the entire payment is late and cannot be remedied by the payment of a 'surcharge on the surcharge' (decision of 07/09/2012, R 1774/2011-1, LAGUIOLE, § 12-15).

The surcharge will not be due if the person submits proof that the payment was initiated more than ten days before the expiry of the relevant time limit.

The Office may set a time limit for the person who made the payment after the expiry of the time limit to submit evidence that one of the above conditions was fulfilled.

For more information on the consequences of late payment in particular proceedings, see the relevant parts of the Guidelines. For example, the Guidelines, Part B, Examination, Section 2, Formalities, deals with the consequences of late payment of the application fee while the Guidelines, Part C, Opposition, Section 1, Procedural Matters, deals with the consequences of late payment of the opposition fee.

4.1.2 Evidence of payment and of the date of payment

Article 76 CTMR Article 8(4) CTMFR Article 63 CDR Article 7(4) CDFR
--

Any means of evidence may be submitted, such as:

- a bank transfer order (e.g. SWIFT order) containing stamps and date of receipt by the bank involved;
- an online payment order sent via the internet or a printout of an electronic transfer provided it contains information on the date of the transfer, on the bank it was sent to, and an indication like 'transfer done'.

In addition, the following evidence may be submitted:

- acknowledgement of receipt of payment instructions by the bank;
- letters from the bank where the payment was effected, certifying the day on which the order was placed or the payment was made, indicating the proceeding for which it was made;
- statements from the party or their representative in writing, sworn or affirmed or having a similar effect under the law of the State in which the statement is drawn up.

This additional evidence is only considered sufficient if supported by the initial evidence.

This list is not exhaustive.

If the evidence is not clear, the Office will send a request for further evidence.

If no evidence is submitted, the procedure for which the payment was made is deemed not to have been entered.

In the event of insufficient proof, or if the payer fails to comply with the Office's request for the missing information, the latter will consider that the time limit for payment has not been observed.

The Office may likewise, within the same time limit, request the person to pay the surcharge. In the event of non-payment of the surcharge, the deadline for payment will be considered not to have been observed.

The fee or charges or the part thereof that have been paid will be reimbursed since the payment is invalid.

Rule 96(2) CTMIR
Article 81(2) CDIR

Language of the evidence: the documents may be filed in any official language of the EU. Where the language of the documents is not the language of the proceedings, the Office may require that a translation be supplied in any language of the Office.

4.2 Payment by debit or credit card

Decision No EX-13-2 of the President of the Office of 26/11/2013 as amended in 2015

Payment by credit or debit card is deemed to have been made on the date on which the relevant electronic filing or request was successfully completed. If, when the Office attempts to debit the credit or debit card, the transaction fails for some reason, payment is considered not to have been made. This applies even when the payer was not responsible for the failure of the transaction.

4.3 Payment by current account

Decision No Ex-96-1 of the President of the Office of 11/01/1996 concerning the conditions for opening current accounts at the Office as amended in 1996, 2003 and 2006

If the payment is made through a current account held with the Office, Decision No EX-96-1 of the President, as amended, ensures that the date on which the payment is deemed to be made is fixed in order to be convenient for the party to the proceedings. For example, for the application fee of a CTM, as a rule, the fees will be debited from the current account on the last day of the one-month time limit given to pay the fee. However, the applicant/representative may instruct the Office to debit their account upon receipt of the CTM application. Likewise, upon renewal, the account holder may choose 'Debit now' or 'Debit on expiry'. If a party withdraws its action

(opposition, cancellation request, appeal, renewal application) before the end of the time limit to make the payment, fees due to be debited on expiry of the time limit to pay the fee will not be debited from the current account and the action will be deemed not to have been filed.

5 Refund of Fees

Article 7(2) and Articles 9 and 13 CTMFR Articles 84, 154 and 156 CTMR Articles 6(2) and 8(1) CDR Article 30(2) CDIR

The refund of fees is explicitly provided for in the regulations. Refunds are given by means of bank transfers or through current accounts with the Office, even when the fees were paid by debit or credit card.

5.1 Refund of application fee

Rule 9(1) and Rule (2) CTMIR Articles 10, 13 and 22 CDIR Article 43(1) CTMR

In the event of the withdrawal of a CTM application, fees are not refunded except if a declaration of withdrawal reaches the Office:

- where payment has been made by bank transfer, before or at the latest on the same day as the amount actually entered the bank account of the Office;
- where payment has been made by debit or credit card, on the same day as the application containing the debit or credit card instructions/details;
- where payment is made by current account, within the one-month time limit for paying the basic application fee or, where written instruction has been given to immediately debit the current account, before or at the latest on the same day on which that instruction was received.

Where the basic application fee has to be refunded, any additional class fees paid will be refunded as well.

The Office will only refund additional class fees on their own where they have been paid in excess of the classes indicated by the applicant in the CTM application and where such payment was not requested by the Office or where, upon examination of the classification, the Office concludes that additional classes have been included that were not required in order to cover the goods and services contained within the original application.

As regards designs, if there are deficiencies that affect the filing date, that is, the filing date is not granted due to those deficiencies, and that are not remedied by the time limit granted by the Office, the design(s) will not be dealt with as a Community design

and any fees paid will be refunded. On the contrary, under no circumstances will the fees be refunded if the design applied for has been registered.

5.2 Refund of the opposition fee

Rules 17(1), 18(5) and 19(1) CTMIR

If an opposition is deemed not entered (because it was filed after the three-month time limit) or if the opposition fee was not paid in full or was paid after the expiry of the opposition period, the Office must refund the fee, including the surcharge.

5.3 Refund of fees for international marks designating the EU

Decision No ADM-11-98 of the President of the Office related to regularisation of certain reimbursement of fees

See the Guidelines, Part M, International Marks, paragraph 3.13.

5.4 Refund of appeal fees

Provisions regarding the refund of appeal fees are dealt with under Rule 51 CTMIR and Article 35(3) and Article 37 CDIR.

5.5 Refund of renewal fees

Rule 30(6) and Rule (7) CTMIR

Fees that are paid before the start of the first six-month time limit for renewal will not be taken into consideration and will be refunded.

Where the fees have been paid, but the registration is not renewed (i.e. where the fee has been paid only after the expiry of the additional time limit, or where the fee paid amounts to less than the basic fee and the fee for late payment/late submission of the request for renewal, or where certain other deficiencies have not been remedied), the fees will be refunded.

Where the owner has instructed the Office to renew the mark, and subsequently either totally or partially (in relation to some classes) withdraws their instruction to renew, the renewal fee will only be refunded:

- if, in the case of payment by bank transfer, the Office received the withdrawal before receiving the payment;
- if, in the case of payment by debit or credit card, the Office received the withdrawal before or on the same day as receiving the debit or credit card payment;

- if, in the case of payment by current account, if already debited, the Office received the withdrawal within the six-month time limit for renewal or, where written instruction was given to debit the current account immediately, before or at the latest on the same day that the Office received the instruction.

For further information, see the Guidelines, Part E, Register Operations, Section 4, Renewal.

5.6 Refund of insignificant amounts

Article 10(1) CTMFR
Article 9(1) CDFR
Decision No EX-03-6 of the President of the Office of 20/01/2003 determining the insignificant amount of fees and charges

A fee will not be considered settled until it has been paid in full. If this is not the case, the amount already paid will be reimbursed after the expiry of the time limit allowed for payment, since in this case the fee no longer has any purpose.

However, insofar as it is possible, the Office may invite the person to complete payment within the time limit.

Where an excess sum is paid to cover a fee or a charge, the excess will not be refunded if the amount is insignificant and the party concerned has not expressly requested a refund. Insignificant amounts are fixed at EUR 15 by Decision No EX-03-6 of the President of the Office of 20/01/2003.

6 Fee Reduction for the CTM Application Filed by Electronic Means

Article 2 (1b) CTMFR
Decision No EX-13-2 of the President of the Office of 26/11/2013 as amended in 2015

According to Article 2(1b) CTMFR, the basic fee for an application for an individual mark may benefit from a reduction if the application has been filed by electronic means. The applicable rules and procedure for such an electronic filing may be found in Decision No EX-13-2 of the President of the Office of 26/11/2013 read in conjunction with the Terms and Conditions related to this Decision.

In order to be considered an application for a CTM filed by electronic means in the sense of Article 2(1b) CTMFR, the applicant has to insert all the goods and/or services to be covered by the application directly into the Office tool. Consequently, the applicant must not include the goods and/or services in an annexed document or submit them by any other means of communication. If the goods and/or services are annexed in a document or submitted to the Office by any other means of communication, the application will not be considered as having been filed by electronic means and may not benefit from the corresponding fee reduction.

7 Decisions on Costs

Article 85 CTMR Rule 94 CTMIR

7.1 Apportionment of costs

In *inter partes* proceedings, the Opposition Division, the Cancellation Division and the Boards of Appeal must take a decision on the apportionment of costs. Those costs include in particular the costs of the professional representatives, if any, and the corresponding fees. For further information relating to the apportionment of costs in opposition proceedings, see the Guidelines, Part C, Opposition, Section 1, Procedural Matters. Where the decision contains obvious mistakes as regards the costs, the parties may ask for a corrigendum (Rule 53 CTMIR) or a revocation (Article 80 CTMR), depending on the circumstances (see the Guidelines, Part A, General Rules, Section 6, Revocation of Decisions, Cancellation of Entries in the Register and Correction of Errors).

7.2 Fixing of costs

The decision fixing the amount of costs includes the lump sum provided in Rule 94 CTMIR for professional representation and fees (see above) incurred by the winning party, independently of whether they have actually been incurred. The fixing of the costs may be reviewed in a specific proceeding pursuant to Article 85(6) CTMR.

7.3. Enforcement of the decision on costs

Article 86 CTMR

The Office is not competent for enforcement procedures. These must be carried out by the competent national authorities.

7.3.1 Conditions

The winning party may enforce the decision on costs, provided that:

- the decision contains a decision fixing the costs in their favour;
- the decision has become final; the party may give evidence that the decision became final by submitting appropriate extracts from the Office's databases or individual confirmation by the Office;
- the decision bears the order of the competent national authority.

7.3.2 National authority

Each Member State will designate a national authority for the purpose of appending the order for the enforcement of Office decisions fixing the costs. The Member State will make the designation known to the Office and to the Court of Justice (Article 86(2) CTMR).

The Office publishes such designations in its Official Journal.

References can be found for:

Austria (OJ OHIM 4/2004, p. 559 and 561);
Belgium (OJ OHIM 4/2007);
Czech Republic (pending publication);
Denmark (OJ OHIM 10/2002, p. 1883);
Estonia (OJ OHIM 10/2009);
France (OJ OHIM 5/2002, p. 886);
Germany (OJ OHIM 6/2005, p. 853 and 855);
Ireland (OJ OHIM 3/2007);
Netherlands (OJ OHIM 12/1999, p. 1517);
Slovakia (OJ OHIM 11/2004, p. 1273);
United Kingdom (OJ OHIM 12/1998, p. 1381).

Certain other Member States have assigned jurisdiction to a national authority (e.g., in the case of Spain, to the General Technical Bureau of the Ministry of Justice as per Royal Decree 1523/1997) but have not yet notified the Office or the CJEU.

7.3.3 Proceedings

- a. The interested party must request the competent national authority to append the enforcement order to the decision. For the time being, the conditions on languages of the requests, translations of the relevant parts of the decision, fees and the need of a representative depend on the practice of the Member States and are not harmonised but are considered on a case-by-case basis.

The competent authority will append the order to the decision without any other formality beyond the verification of the authenticity of the decision. As to wrong decisions on costs or fixing of costs, see paragraphs 7.1 and 7.2 above.

- b. If the formalities have been completed, the party concerned may proceed to enforcement. Enforcement is governed by the rules of civil procedure in force in the territory where it is carried out. The enforcement may be suspended only by a decision of the Court of Justice of the European Union. However, the courts of the country concerned have jurisdiction over complaints that enforcement is being carried out in an irregular manner (Article 86(4) CTMR).

***GUIDELINES FOR EXAMINATION IN THE
OFFICE FOR HARMONIZATION IN THE
INTERNAL MARKET (TRADE MARKS AND
DESIGNS) ON COMMUNITY TRADE MARKS***

PART A

GENERAL RULES

SECTION 5

PROFESSIONAL REPRESENTATION

Table of Contents

1	Introduction – Principle of Representation	4
2	Who May Represent	4
2.1	Database of representatives	5
2.2	Professional representation by legal practitioners	6
2.2.1	The term ‘legal practitioner’	6
2.2.2	Qualification	6
2.2.3	Nationality and place of business	6
2.2.4	Entitlement to act in trade mark and/or design matters	7
2.3	Professional representatives admitted and entered on the lists maintained by the Office	7
2.3.1	Entitlement under national law	8
2.3.2	Nationality and place of business	9
2.3.3	Certificate	9
2.3.4	Exemptions	10
2.3.5	Procedure for entry on the list	10
2.3.6	Amendment of the list of professional representatives	10
2.3.6.1	Deletion	10
2.3.6.2	Suspension of the entry on the list	11
2.3.7	Reinstatement in the list of professional representatives	12
2.4	Representation by an employee	12
2.4.1	Employees acting for their employer	13
2.4.2	Representation by employees of a legal person with economic connections	13
2.5	Legal representation	14
3	Appointment of a Professional Representative	14
3.1	Conditions under which appointment is mandatory	14
3.1.1	Domicile and place of business	15
3.1.2	The notion of ‘in the Community’	15
3.2	Consequences of non-compliance when appointment is mandatory ..	15
3.2.1	During registration	16
3.2.2	During opposition	16
3.2.3	Cancellation	17
3.3	Appointment of a representative when not mandatory	17
3.4	Appointment of a representative	17
3.4.1	Explicit appointment	17
3.4.2	Implicit appointment	18
3.4.3	Associations of representatives	18
3.4.4	ID numbers	19
4	Communication with Representatives	19
5.	Authorisation	20

5.1	Individual authorisations	21
5.2	General authorisations.....	21
5.2.1	Registration of General Authorisations.....	21
5.3	Consequences where authorisation expressly requested by the Office is missing.....	21
6	Withdrawal of a Representative’s Appointment or Authorisation.....	22
6.1	Action taken by the person represented	22
6.2	Withdrawal by the representative.....	22
7	Death or Legal Incapacity of the Party Represented or Representative.....	22
7.1	Death or legal incapacity of the party represented	22
7.2	Death or legal incapacity of the representative.....	23

1 Introduction – Principle of Representation

Articles 92(1) and (2) and 93(1) CTMR, Rule 76 CTMIR, Article 77 CDR

Persons having their domicile or their principal place of business or a real and effective industrial or commercial establishment in the European Union are not required to be represented in any proceedings before the Office (see paragraph 3.1.1 below).

Natural persons not domiciled or legal persons that do not have their principal place of business or a real and effective industrial or commercial establishment in the European Union must be represented by a representative based within the European Union. This obligation exists in all proceedings before the Office, except for the act of filing an application for a CTM or an RCD. See paragraph 3.2.1 below on the consequences of not appointing a representative, when representation is mandatory, once the CTM application has been filed.

Representation is not required for applications to renew CTMs or RCDs or for filing an application for inspection of files.

In principle, representatives do not need to file an authorisation to act before the Office unless the Office expressly requires it, or where, in *inter partes* proceedings, the other party expressly requests it. However, employees acting on behalf of natural or legal persons must file a signed authorisation for insertion in the files.

Where a representative has been appointed, the Office will communicate solely with that representative.

For further information on specific aspects of professional representation during proceedings before the Office in relation to international marks, please consult the Guidelines, Part M, International Marks.

The first part of this section (paragraph 2) defines the different types of representatives.

The second part of this section (paragraphs 3 to 6) deals with the appointment of representatives or failure to do so and the authorisation of representatives.

2 Who May Represent

Article 92(3) and Article 93(1)(a) and (b) CTMR, Rule 76 CTMIR, Article 77(3) and Article 78(1)(a) and (b) CDR

In all Member States, representation in legal proceedings is a regulated profession and may only be exercised under particular conditions. The terminology of Article 93 CTMR encompasses different categories of representative under the heading 'Professional representatives'. In proceedings before the Office, the following categories of representative are distinguished:

Legal practitioners (Article 93(1)(a) CTMR, Article 78(1)(a) CDR) are professional representatives who, depending on the national law, are always qualified to represent third parties before national offices (See paragraph 2.2).

Other professionals (Article 93(1)(b) CTMR, Article 78(1)(b) CDR) need to comply with further conditions and need to be included on a specific list maintained by the Office for this purpose (the Office's list of professional representatives). Amongst these, two further groups need to be distinguished: those who may represent only in Community Design (CD) proceedings ('designs list') and those who may represent in both CTM and CD proceedings (see paragraph 2.3). The Office refers to these other professionals collectively as '**professional representatives**'.

Several legal practitioners and professional representatives may be organised in entities called '**associations of representatives**' (Rule 76(9) CTMIR) (see paragraph 3.4.3).

The final category of representatives is made up of **employees** acting as representatives for the party to proceedings before the Office (Article 92(3) CTMR, first alternative) (see paragraph 2.4.1) or employees of **economically linked** legal persons (Article 92(3) CTMR, second alternative) (see paragraph 2.4.2).

Employees are to be distinguished from **legal representatives** under national law (see paragraph 2.5).

2.1 Database of representatives

All persons that identify themselves as representatives for or employees of individual parties to proceedings before the Office and that fulfil the requirements provided by the regulations are entered into the database of representatives and obtain an ID number. The database has a double function, providing all relevant contact details under the specific ID number for any type of representative as well as the public information on the Office's list of professional representatives or designs list.

All representatives, including associations of representatives, must indicate the category of representative to which they belong, their name and their address in accordance with Rule 1 CTMIR.

A representative may have several IDs. For example, associations of representatives may have different IDs for different official addresses (to be distinguished from different correspondence addresses, which can be identified under a single ID; see the Guidelines, Part E, Register Operations, Section 1, Changes in a Registration). Individual representatives may have one ID as an employee representative and a different ID as a legal practitioner in their own right.

A legal practitioner cannot, in principle, appear in the database as an 'Office professional representative', since they do not need to be admitted by the Office. The Office, therefore, almost invariably refuses requests from legal practitioners to be entered on the list of Office professional representatives. The only exception is where a professional representative on the list is also a legal practitioner and such dual qualification is allowed under national law.

The database of professional representatives is available online. In the database, representatives are identified as: association, employee, lawyer (legal practitioners), and professional representative. Internally, the latter category is divided into two subcategories: type 1 consists of design attorneys exclusively entitled to represent in CD matters under Article 78 CDR and type 2 of trade mark and design attorneys under Article 93 CTMR.

2.2 Professional representation by legal practitioners

Article 93(1)(a) CTMR

A legal practitioner is a professional representative who is automatically and without any further formal recognition allowed to represent third parties before the Office provided that they meet the following three conditions:

- a) they must be qualified in one of the Member States;
- b) they must have their place of business within the European Union; and
- c) they must be entitled, within that State, to act as a representative in trade mark and/or design matters.

2.2.1 The term 'legal practitioner'

Directive 98/5/EC of the European Parliament and of the Council defines the term 'lawyer' (i.e. legal practitioner). The professional titles are identified in the column 'Terminology for legal practitioner' in Annex 1 of this section.

2.2.2 Qualification

The requirement to be qualified in one of the Member States means that the person must be admitted to the bar or be admitted to practise under one of the professional titles identified in Annex 1 pursuant to the relevant national rules. The Office will not verify this unless there are serious doubts in this regard.

2.2.3 Nationality and place of business

There is no requirement as to nationality. Therefore, the legal practitioner may be a national of a state other than one of the Member States.

The place of business must be in the European Union (for the definition of what constitutes the European Union, see paragraph 3.1.2 below). A PO box address does not constitute a place of business. The place of business need not necessarily be the only place of business of the representative. Furthermore, the place of business may be in another Member State than the one in which the legal practitioner is admitted to the bar. However, legal practitioners who have their sole place of business outside of the European Union are not entitled to represent before the Office even when they are admitted to practise in one of the Member States.

Where an association of representatives, such as a law firm or a law office, has several places of business, it may perform acts of representation only under a place of business within the European Union, and the Office will communicate with the legal practitioner only at an address within the European Union.

2.2.4 Entitlement to act in trade mark and/or design matters

The entitlement to act as a representative in trade mark and/or design matters in a state must include the entitlement to represent clients before the national industrial property office of that state. This condition applies to all Member States.

Legal practitioners referred to in Article 93(1)(a) CTMR who fulfil the conditions laid down in this article are automatically entitled as of right to represent their clients before the Office. This basically means that if a legal practitioner is entitled to act in trade mark and/or design matters before the central industrial property office of the Member State in which they are qualified, they will also be able to act before the Office. Legal practitioners are not entered on the list of professional representatives to which Article 93(2) CTMR refers, because the entitlement and the special professional qualifications referred to in those provisions relate to persons belonging to categories of professional representatives specialising in industrial property or trade mark matters, whereas legal practitioners are by definition entitled to be representatives in all legal matters.

If a legal practitioner (lawyer) who has already been attributed an identification number as a lawyer requests entry on the list, the number will be maintained but the status will be changed from 'lawyer' to 'professional representative'. The only exception is where a professional representative on the list is also a legal practitioner and is allowed, under national law, to act in both contexts.

Annex 1 gives a detailed explanation of the specific rules for each country.

2.3 Professional representatives admitted and entered on the lists maintained by the Office

Article 93(1)(b) and Article 93(2) CTMR and Article 78(1)(b) CDR
--

The second group of persons entitled to represent third parties professionally before the Office are those persons whose names appear on one of the two lists of professional representatives maintained by the Office, the Office's list of professional representatives and the designs list.

For this category of professional representatives, the entry on the Office's list of professional representatives or designs list entitles them to represent third parties before the Office. A representative who is entered on the Office's list of professional representatives, referred to in Article 93(1)(b) CTMR, is automatically entitled to represent third parties in design matters according to Article 78(1)(b) CDR and will not be entered on the special list of professional representatives in design matters ('designs list').

If a person on the list maintained under Article 93 CTMR requests entry on the designs list maintained for professional representatives authorised to act exclusively in Community Designs matters under Article 78(4) CDR, the request will be rejected.

The designs list is intended only for professional representatives who are entitled to represent clients before the Office in design matters but not trade mark matters.

Annex 2 gives a detailed explanation of the specific rules for each country.

Entry on the lists is subject to a request being completed and signed individually by the person concerned, using the form established for this purpose by the Office at: http://oami.europa.eu/pdf/forms/prorep_form93_en.pdf.

In order to be entered on the list, three requirements must be fulfilled:

- a) the representative must be a national of one of the Member States;
- b) they must have their place of business within the Community; and
- c) they must be entitled under national law to represent third parties in trade mark matters before the national industrial property office. To that end they must provide a certificate attesting this from the national industrial property office of a Member State.

2.3.1 Entitlement under national law

The conditions for entry on the Office's list of professional representatives and the designs list depend on the legal situation in the Member State concerned.

Article 93(2)(c) CTMR and Article 78(1)(b) CDR
--

In a large number of Member States, entitlement to represent third parties before the national office in trade mark matters is conditional upon possession of a special professional qualification (Article 93(2)(c) CTMR, first alternative). Therefore, in order to be entitled to act as a representative, the person must have the required qualification. In other Member States, there is no such requirement for a special qualification, that is to say, representation in trade mark matters is open to anybody. In this case, the person involved must have regularly represented third parties in trade mark or design matters before the national office concerned for at least five years (Article 93(2)(c) CTMR, second alternative). A subcategory of this category of Member States are those Member States that have a system officially recognising a professional qualification to represent third parties before the national office concerned although such recognition is not a prerequisite for the exercise of professional representation. In this case, persons so recognised are not subject to the requirement of having regularly acted as a representative for at least five years.

First alternative – Special professional qualifications

Where, in the Member State concerned, entitlement is conditional upon having special professional qualifications, persons applying to be entered on the list must have acquired this special professional qualification.

This special professional qualification (often by means of an examination) is required in Austria, Bulgaria, Croatia, the Czech Republic, Estonia, France, Germany, Hungary, Ireland, Italy, Latvia, Lithuania, Poland, Portugal, Romania, Slovakia, Slovenia, Spain and the United Kingdom.

If the person confirms that they work for two different associations of representatives or from two different addresses, then they can have two different numbers attributed. It is also possible to have two different numbers, one as a lawyer and one as an Office

professional representative where such a dual qualification is allowed under national law (e.g. this is not compatible in Belgium and France).

Second alternative – Five years' experience

Where, in the Member State concerned, the entitlement is not conditional upon possession of special professional qualifications, persons applying to be entered on the list must have regularly acted as professional representatives for at least five years before a central industrial property office of a Member State.

It is possible for the President to grant an exemption from this requirement (see paragraph 2.3.4).

This is the case for Benelux, Denmark, Malta, Finland and Sweden.

Third alternative – Recognition by a Member State

Persons whose professional qualification to represent natural or legal persons in trade mark and/or design matters before the central industrial property office of one of the Member States is officially recognised in accordance with the regulations laid down by that State shall not be subject to the condition of having exercised the profession for at least five years.

2.3.2 Nationality and place of business

Article 93(2)(a) and (b) and Article 93(4) CTMR

A professional representative requesting to be entered on the list must be a national of a Member State and must have their place of business or employment in the European Union. Entitlement to act as a representative in other Member States, and professional experience obtained therein, can be taken into account only within the scope of Article 93(4) CTMR. It is possible for the President to grant an exemption from this requirement (see paragraph 2.3.4).

2.3.3 Certificate

Article 93(3) CTMR

Fulfilment of the abovementioned conditions laid down in Article 93(2) CTMR must be attested by a certificate provided by the national office concerned. Some national offices issue individual certificates while others provide the Office with block certificates. They send regularly updated lists of professional representatives entitled to represent clients before their office (Communication No 1/95 of the President of the Office of 18/09/1995; OJ OHIM 1995, 16). Otherwise, the person concerned must accompany their request with an individual certificate (see http://oami.europa.eu/pdf/forms/prorep_form93_certificate_en.pdf).

2.3.4 Exemptions

Article 93(4) CTMR

The President of the Office may, under special circumstances, grant exemption from the requirement to be a national of a Member State and from the requirement of having regularly represented in trade mark matters for at least five years, provided that the professional representative submits proof that they have acquired the required qualification in another way. This power is of a discretionary nature.

All the cases presented to the President of the Office so far have allowed him to grant an exemption from the nationality requirement. Exemptions from the requirement for five years' experience are limited to where a qualification to act as a representative in trade mark matters acquired in another way has already been valid for the equivalent period.

For example, this comprises cases where the professional representative, before becoming an industrial property agent, was responsible for trade mark operations within a company without having personally acted before the national office concerned. The experience must have been acquired in a Member State.

2.3.5 Procedure for entry on the list

Article 93(3) CTMR and Article 78 CDR

Entry on the list is confirmed by notification of a positive decision, which contains the indication of the ID number attributed to the professional representative. Entries on the Office's list of professional representatives or designs list are published in the Official Journal of the Office.

If any of the requirements for entry on the list are not fulfilled, and after the applicant has been given the opportunity to reply to the Office's deficiency notification to that effect, a rejection decision will be issued unless the applicant remedies the said deficiency. The party concerned may file an appeal against this decision (Article 58(1) CTMR and Article 133 CTMR).

Professional representatives may obtain an additional copy of the decision without the payment of a fee. The files relating to requests for entry on the Office's list of professional representatives or designs list are not open to public inspection.

2.3.6 Amendment of the list of professional representatives

2.3.6.1 Deletion

First alternative, upon own request

Rule 78(1) and (6) CTMIR and Article 64(1) and (6) CDIR

The entry of a professional representative on the Office's list of professional representatives or designs list will be deleted at the request of that representative.

The deletion will be entered in the files kept by the Office. The notification of deletion will be sent to the representative and the deletion will be published in the Official Journal of the Office.

Second alternative, automatic deletion from the list of professional representatives

Rule 78(2) and (5) CTMIR, Article 64(2) and (5) CDIR
--

The entry of a professional representative in the Office's list of professional representatives or designs list will be deleted automatically:

- a) in the event of the death or legal incapacity of the professional representative;
- b) where the professional representative is no longer a national of a Member State; however, the President of the Office may still grant an exemption under Article 93(4)(b) CTMR;
- c) where the professional representative no longer has their place of business or employment in the EU; or
- d) where the professional representative is no longer entitled to represent third parties before the central industrial property office of a Member State.

Where the professional representative changes from a Design Attorney to a trade mark attorney they will be removed from the designs list and introduced in the Office's list of professional representatives.

The Office may be informed of the above events in a number of ways. In case of doubt, the Office will, prior to deletion from the list, seek clarification from the national office concerned. It will also hear the professional representative, in particular where there is a possibility that they are entitled to remain on the list on another legal or factual basis.

The deletion will be entered in the files kept by the Office. The decision of the deletion will be notified to the representative and the deletion will be published in the Official Journal of the Office. The party concerned can lodge an appeal against this decision (Decision 2009-1 of the Presidium of the Boards of Appeal of 16 June 2009 regarding Instructions to Parties in Proceedings before the Boards of Appeal).

2.3.6.2 Suspension of the entry on the list

Rule 78(3) and (5) CTMIR and Article 64(3) CDIR

The entry of the professional representative on the Office's list of professional representatives or designs list will be suspended of the Office's own motion where their entitlement to represent natural or legal persons before the national industrial property office of a Member State has been suspended.

The national industrial property office of the Member State concerned must, where aware of any such events, promptly inform the Office thereof. Before taking a decision to suspend the entry, which will be open to appeal, the Office will inform the representative and give them an opportunity to make comments (Decision 2009-1 of the Presidium of the Boards of Appeal of 16 June 2009 regarding Instructions to Parties in Proceedings before the Boards of Appeal).

2.3.7 Reinstatement in the list of professional representatives

Rule 78(4) CTMIR and Article 64(4) CDIR

A person whose entry has been deleted or suspended will, upon request, be reinstated in the list of professional representatives if the conditions for deletion or suspension no longer exist.

A new request must be submitted in accordance with the normal procedure for obtaining an entry on the list of professional representatives (see paragraph 2.2 above).

2.4 Representation by an employee

Article 92(3) CTMR and Article 77(3) CDR
--

Natural or legal persons whose domicile, principal place of business or real and effective industrial or commercial establishment is in the Community may act before the Office through a natural person employed by them ('employee').

A natural person whose domicile is outside the Community cannot designate an employee representative in the EU.

Employees of the abovementioned legal persons may also act on behalf of other legal persons who have economic connections with the first legal person (decision of 25/01/2012, R 0466/2011-4, FEMME LIBRE, § 10) (see paragraph 2.4.2). This applies even if those other legal persons have neither their domicile nor their principal place of business nor a real and effective industrial or commercial establishment within the EU (see paragraph 2.4.2). Where a legal person from outside the EU is represented in this way, it is not required to appoint a professional representative within the meaning of Article 93(1) CTMR, as an exception to the rule that parties to the proceedings domiciled outside the EU are obliged to appoint a professional representative.

Rule 83(1)(h) CTMIR

On the forms made available by the Office pursuant to Rule 83(1) CTMIR, the employee signing the application or request must indicate their name and tick the checkboxes relating to employees and authorisations, and fill in the field reserved for professional representatives on page 1 of the form or the sheet with details relating to professional representatives.

Rule 12(b) and Rule 84(2)(e) CTMIR

The name(s) of the employee(s) will be entered in the database and published under 'representatives' in the Community Trade Marks Bulletin.

2.4.1 Employees acting for their employer

Article 92(3) CTMR, Rule 76(2) CTMIR, Article 77(3) CDR

Where employees act for their employer, this is not a case of professional representation under Article 93(1) CTMR. As such, Rule 94(7)(d) CTMIR is not applicable for the apportionment and fixing of costs in *inter partes* proceedings (decision of 03/02/2011, R 0898/2010-1, MYBEAUTY, § 11 and 12).

Natural or legal persons party to proceedings before the Office may act through their employees, subject only to the requirement that the employee must file an authorisation (decision of 25/01/2012, R 0466/2011-4, FEMME LIBRE, § 9). No other requirements, for example that the employees be qualified to represent third parties before national offices, need be met.

The Office will not generally verify whether there actually is an employee relationship with the party to the proceedings, but may do so where it has reason to doubt that an employment relationship exists, such as when different addresses are indicated or when one and the same person is nominated as the employee of different legal persons.

2.4.2 Representation by employees of a legal person with economic connections

Article 92(3) CTMR and Article 77(3) CDR

Employees of legal persons may represent other legal persons provided that the two legal persons have economic connections with each other. Economic connections in this sense exist when there is economic dependence between the two legal persons, either in the sense that the party to the proceedings is dependent on the employer of the employee concerned, or vice versa. This economic dependence may exist:

- either because the two legal persons are members of the same group; or
- because of management control mechanisms.

In accordance with Article 2 of Commission Directive 80/723/EEC of 25/06/1980 (OJ L 195, 29/07/1980, p. 35) on the transparency of financial relations between Member States and public undertakings, and Article 10 of Commission Regulation No 240/96 of 31/01/1996 on the application of Article 85(3) of the Treaty to certain categories of technology transfer agreements (OJ L 31, 09/02/1996, p. 2), one enterprise has economic connections with another:

- if it holds more than half of the capital of the other; or
- if it holds more than half of the voting rights; or
- if it may appoint more than half the members of the managing body; or
- if it has the right to manage the affairs of the undertaking.

In accordance with the jurisprudence on Article 106 TFEU, there are also economic connections where both enterprises form an economic unit within which the subsidiary or branch does not have genuine autonomy in determining its marketing strategy.

On the other hand, the following are not sufficient to establish economic connections:

- a connection by virtue of a trade mark licensing agreement;
- a contractual relationship between two enterprises aimed at mutual representation or legal assistance;
- a mere supplier/client relationship, e.g. on the basis of an exclusive distribution or franchising agreement.

Where an employee representative wishes to rely on economic connections, they must tick the relevant section in the official form, and indicate their name and the name and address of their employer. It is recommended to give an indication of the nature of the economic connection, unless evident from the documents submitted. The Office will not generally make any enquiries in this regard, unless it has reason to doubt that economic connections exist. In this case, the Office may ask for further explanation and, where necessary, documentary evidence.

2.5 Legal representation

Legal representation refers to the representation of natural or legal persons through other persons in accordance with national law. For example, the president of a company is the legal representative of that company.

Furthermore, there is no representation within the meaning of the CTMR when, in accordance with the applicable national law, a natural or legal person acts, in particular circumstances, through a legal representative, for example when minors are represented by their parents or by a custodian, or a company is represented by a liquidator. In these cases, the person actually signing must demonstrate their capacity to sign, but is not required to provide an authorisation.

It should be borne in mind, however, that a legal person addressing the Office from outside the European Union must be represented by a professional representative within the European Union. This obligation exists for all proceedings before the Office, except for the act of filing a CTM (representation is not required for applications to renew CTMs or RCDs or for filing an application for inspection of files). See paragraph 3.2.1 below on the consequences of not appointing a representative, when representation is mandatory, once the CTM application has been filed.

3 Appointment of a Professional Representative

3.1 Conditions under which appointment is mandatory

Subject to the exception outlined in paragraph 2.4 above, the appointment of a professional representative is mandatory for parties to proceedings before the Office that have neither domicile nor their principal place of business nor a real and effective industrial or commercial establishment in the European Union. This obligation exists for all proceedings before the Office, except for the filing of a CTM.

The same applies to international registrations designating the EU. For further information on this point, please consult the Guidelines, Part M, International Marks.

3.1.1 Domicile and place of business

The criterion for mandatory representation is the domicile or place of business or commercial establishment, not nationality. For example, a French national domiciled in Japan has to be represented, but an Australian national domiciled in Belgium does not have to be. The Office will determine this criterion with respect to the address indicated. Where the party to the proceedings indicates an address outside of the EU, but relies on a place of business or establishment within the EU, it must give the appropriate indications and explanations, and any correspondence with that party will have to be made to the address in the EU. The criteria of the principal place of business or real and effective industrial or commercial establishment are not fulfilled where the party to the proceedings merely has a post office box or an address for service in the EU, nor where the applicant indicates the address of an agent with a place of business in the EU. A subsidiary is not a real and effective industrial or commercial establishment since it has its own legal personality (decision of 01/04/2014, R 1969/2013-4, DYNATRACE, § 17-19). Where the party to the proceedings indicates an address within the EU as its own address, the Office will not investigate the matter further unless exceptional reasons give rise to some doubt.

For legal persons, the domicile is determined in accordance with Article 65 TFEU. The actual seat or main domicile must be in the EU. It is not sufficient that the law governing the company is the law of a Member State.

3.1.2 The notion of 'in the Community'

Article 92(2) CTMR

In applying Article 92(2) CTMR, the relevant territory is the territory of the European Union, which refers to all of the Member States to which the TFEU applies under Article 355. It should be borne in mind that members of the European Economic Area falling outside the EU (i.e. EFTA Member States) are not considered to fulfil this requirement (decision of 22/06/2011, R 2020/2010-4, GRAND PRIX, § 13-14).

3.2 Consequences of non-compliance when appointment is mandatory

Article 93(1) CTMR

Where a party to proceedings before the Office (applicant, proprietor/holder, opponent, cancellation applicant) is in one of the situations described under paragraph 3.1, but has failed to appoint a professional representative within the meaning of Article 93(1) CTMR in the application or request, or where compliance with the representation requirement ceases to exist at a later stage (e.g. where the representative withdraws) the legal consequences depend on the nature of the proceedings concerned.

3.2.1 During registration

Article 92(2) CTMR and Rule 9(3) CTMIR

Where representation is mandatory and the CTM applicant fails to designate a professional representative in the application form, the examiner will invite the applicant to appoint a representative within a two-month time limit as part of the formality examination pursuant to Rule 9(3) CTMIR. Where the applicant fails to comply with this communication, the CTM application will be refused.

The same course of action will be taken where the appointment of a representative ceases to exist later during the registration process, up until any time before actual registration, that is to say even within the period between publication of the CTM application and registration of the CTM.

Where a specific ('secondary') request is introduced on behalf of the CTM applicant during the registration process, e.g. a request for inspection of files, a request for registration of a licence or a request for *restitutio in integrum*, the appointment of a representative need not be repeated, but the Office may in case of doubt request an authorisation. The Office will in this case communicate with the representative on file, and the representative for the recordal applicant, where different.

3.2.2 During opposition

For CTM applicants, the preceding paragraphs apply. The procedure to remedy any deficiencies relating to representation will take place outside the opposition proceedings, which are terminated by the refusal of the CTM application where the applicant fails to comply with the communication.

Rule 15(2)(h)(ii) and Rule 17(4) CTMIR

As regards the opponent, any initial deficiency relating to representation is a ground for inadmissibility of the opposition. Where the notice of opposition fails to contain the appointment of a representative, the examiner will, pursuant to Article 93(1) CTMR, invite the opponent to appoint a representative within a two-month time limit. The opposition will be rejected as inadmissible unless this requirement is satisfied within the time limit set (See paragraph 2.4.2.6 of the Guidelines, Part B, Examination, Section 1, Proceedings).

When a representative resigns, the proceedings continue with the opponent itself if it is from the EU. The other party is informed of the resignation of the representative. If the party whose representative has resigned is from outside the EU, a letter is sent informing the party concerned that, under the terms of Article 92(2) CTMR, parties not having their domicile or their place of business or a real and effective industrial or commercial establishment in the Community must be represented before the Office in accordance with Article 93(1) CTMR in all proceedings other than in filing the application, and that a new representative must be appointed within a two-month time limit.

Failure to do so will result in the opposition being rejected as inadmissible.

When there is a change of representative during opposition proceedings, the Office will inform the other party of such a change by sending a copy of the letter and of the authorisation (if submitted).

3.2.3 Cancellation

Rule 37(c)(ii) and Rule 39(3) CTMIR

In cancellation proceedings, the above paragraph concerning opposition applies *mutatis mutandis* to the applicant for revocation or declaration of invalidity of a CTM.

Where the proprietor of the CTM is no longer represented, the examiner will invite them to appoint a representative. If they do not do so, procedural statements made by them will not be taken into account, and the request will be dealt with on the basis of the evidence that the Office has before it. However, the CTM will not be cancelled simply because the CTM proprietor is no longer represented after registration.

3.3 Appointment of a representative when not mandatory

Where the party to the proceedings before the Office is not obliged to be represented, they may nevertheless, at any time, appoint a representative within the meaning of Article 92 or 93 CTMR. If they do so, paragraph 3.4 is applicable, as are the requirements concerning authorisation (see paragraph 5 below).

Where a representative has been appointed, the Office will communicate solely with that representative (see under paragraph 4 below).

3.4 Appointment of a representative

3.4.1 Explicit appointment

A representative is normally appointed in the official form of the Office initiating the procedure involved, e.g. the Application Form or the Opposition Form. More than one representative (up to a maximum of two) may be appointed by ticking the appropriate box 'multiple representatives' and giving the necessary details for each of the additional representatives.

A representative may also be appointed in a subsequent communication, whether signed by the party to the proceedings or by the representative (self-appointment). The appointment must be unequivocal.

If there is no representative in the proceedings, a communication made in respect of a particular procedure (e.g. registration or opposition), accompanied by an authorisation signed by the party to the proceedings, implies the appointment of a representative. This also applies where a General Authorisation is filed in the same way. For information about General Authorisations, see paragraph 5.2 below.

If there is already a representative in the proceedings, the represented person has to clarify if the former representative will be replaced.

3.4.2 Implicit appointment

Submissions, requests, etc. filed on behalf of the parties by a representative (hereafter: the 'new' representative) other than the one who appears in our register (hereafter: the 'old' representative) will initially be accepted.

The Office will then send a letter to the 'new' representative inviting them to confirm their appointment within one month. The letter will include a warning that if the representative does not reply within the time limit, the Office will assume that they have not been appointed as representative.

If the 'new' representative confirms their appointment, the submission will be taken into account and the Office will send further communications to the 'new' representative.

If the 'new' representative does not reply within one month or if they confirm that they are not the 'new' representative, the proceedings will go on with the 'old' representative. The submission and the answer from the 'new' representative will not be taken into account and will be forwarded to the 'old' representative for information purposes only.

In particular, when the submission leads to closure of the proceedings (withdrawals/limitations) the 'new' representative must confirm their appointment as representative so that the closure of proceedings or the limitation can be accepted. In any case, the proceedings will not be suspended.

3.4.3 Associations of representatives

Rule 76(9) CTMIR

An association of representatives (such as firms or partnerships of lawyers or professional representatives or both) may be appointed rather than the individual representatives working within that association.

This must be indicated accordingly, with only the name of the association of representatives to be indicated, and not the names of the individual representatives working within that association. Experience has shown that in many instances equivocal indications are made. In such cases, the Office will, wherever possible, interpret such indications as the appointment and authorisation of an association of representatives, but if appropriate, advise the representative for future cases.

The appointment of an association of representatives automatically extends to any professional representative who, subsequent to the initial appointment, joins that association of representatives. Conversely, any representative who leaves the association of representatives automatically ceases to be authorised under that association. It is neither required nor recommended to provide information to the Office of the names of the representatives of whom the association consists. However, it is strongly recommended that any changes and information concerning representatives leaving the association be notified to the Office. The Office reserves the right to verify whether a given representative actually works within the association if this is justified under the circumstances of the case.

Article 93(1) CTMR, Rule 76 CTMIR

The appointment of an association of representatives does not result in departure from the general rule that only professional representatives within the meaning of Article 93(1) CTMR may perform legal acts before the Office on behalf of third parties. Thus, any application, request or communication must be signed by a physical person possessing this qualification. The representative must indicate their name underneath the signature. They may indicate their individual ID number, if given by the Office, although it is not necessary to obtain an individual ID number, as the association ID number prevails.

3.4.4 ID numbers

On any form and in any communication sent to the Office, the representative's address and telecommunication details may, and preferably should, be replaced by the ID number attributed by the Office, together with the representative's name. Not only Office professional representatives entered on the list maintained by the Office (see paragraph 2.2 above), but also legal practitioners and associations of representatives, will have such ID numbers. Furthermore, where representatives or associations of representatives have several addresses, they will have a different ID number for each of those addresses.

The ID number can be found by consulting any of the files of the representative in question through our website: www.oami.europa.eu

4 Communication with Representatives

Rule 77 CTMIR

Any notification or other communication addressed by the Office to the duly authorised representative will have the same effect as if it had been addressed to the represented person, and any communication addressed to the Office by the duly authorised representative will have the same effect as if it originated from the represented person (decision of 24/11/2011, R 1729/2010-1, WENDY'S OLD FASHIONED HAMBURGERS, § 21).

Rule 1(1)(e), Rules 67(2) and 76(8) CTMIR

A party to the proceedings before the Office may appoint several representatives, in which case each of the representatives may act either jointly or separately, unless the authorisation given to the Office provides otherwise. The Office, however, will as a matter of course communicate only with the first-named representative, except in the following cases:

- where the applicant indicates a different address as the address for service in accordance with Rule 1(1)(e) CTMIR;
- where the additional representative is appointed for a specific secondary procedure (such as inspection of files or opposition), in which case the Office will proceed accordingly.

Rule 75(1) CTMIR

Where there is more than one CTM applicant, opponent or any other party to proceedings before the Office, the representative appointed by the CTM applicant, etc. that is named first in the official form will be the common representative for all those persons. If the person named first has not appointed a professional representative and one of the other persons is obliged to, and does, appoint a professional representative, that representative will be considered to be the common representative for all those persons.

Where one of the co-owners is obliged to be represented before the Office but does not appoint a professional representative, the Office will communicate with the first person named in the official form who is based within the EU.

Articles 92 and 93 CTMR and Rule 67 CTMIR

Where a representative within the meaning of Articles 92 or 93 CTMR has been appointed, the Office will communicate solely with that representative.

5. Authorisation

Articles 92(3) and 93(1) CTMR and Rule 76 CTMIR

In principle, professional representatives do not need to file an authorisation to act before the Office. However, any professional representative (legal practitioner or Office professional representative entered on the list, including an association of representatives) acting before the Office must file an authorisation for insertion in the files if the Office expressly requires this or, where there are several parties to the proceedings in which the representative acts before the Office, if the other party expressly asks for this.

In such cases, the Office will invite the representative to file the authorisation within a specific time limit (see the Guidelines, Part A, General Rules, Section 1, Means of Communication, Time Limits). The letter will include a warning that if the representative does not reply within the time limit, the Office will assume that they have not been appointed as representative and proceedings will continue directly with the party represented. Where representation is mandatory, the party represented will be invited to appoint a new representative and paragraph 3.2 above applies. Any procedural steps, other than the filing of the application, taken by the representative will be deemed not to have been taken if the party represented does not approve them within a period specified by the Office.

Employees acting on behalf of natural or legal persons must file a signed authorisation for insertion in the files.

An authorisation must be signed by the party to the proceedings. In the case of legal persons, it must be signed by a person who is entitled, under the applicable national law, to act on behalf of that person. The Office will not verify this.

Simple photocopies of the signed original may be submitted, including by fax. Original documents become part of the file and, therefore, cannot be returned to the person who submitted them.

Authorisations may be submitted in the form of individual or general authorisations.

5.1 Individual authorisations

Rule 76(1) and Rule 83(1)(h) CTMIR

Individual authorisations may be made on the form established by the Office pursuant to Rule 83(1)(h) CTMIR. The procedure to which the authorisation relates must be indicated (e.g. 'concerning CTM application number 12345'). The authorisation will then extend to all acts during the lifetime of the ensuing CTM registration. Several proceedings may be indicated.

Individual authorisations, whether submitted on the form made available by the Office or on the representative's own form, may contain restrictions as to its scope.

5.2 General authorisations

Rule 76(1) and Rule 83(1)(h) CTMIR

A 'general authorisation' authorises the representative, the association of representatives or the employee to perform all acts in all proceedings before the Office, including, but not limited to, the filing and prosecution of CTM applications, the filing of oppositions and the filing of requests for a declaration of revocation or invalidity, as well as in all proceedings concerning registered Community designs and international marks. The authorisation should be made on the form made available by the Office, or a form with the same content. The authorisation must cover all proceedings before the Office and may not contain limitations. For example, where the text of the authorisation relates to the 'filing and prosecution of CTM applications and defending them', this is not acceptable because it does not cover the authority to file oppositions and requests for a declaration of revocation or invalidity. Where the authorisation contains such restrictions, it will be treated as an individual authorisation.

5.2.1 Registration of General Authorisations

Since April 2002, and in accordance with Communication No 2/03 of the President of the Office of 10/02/2003, representatives will no longer be issued an authorisation number and will not be notified in any way regarding the internal handling of authorisations following receipt at the Office. However, termination of issuing such authorisation numbers does not affect the issuing of ID numbers to representatives entered in the database of representatives.

5.3 Consequences where authorisation expressly requested by the Office is missing

- a) If representation is not mandatory, the proceedings will continue with the person represented.
- b) If representation is mandatory, paragraph 3.2 above will apply.

6 Withdrawal of a Representative's Appointment or Authorisation

A withdrawal or change of representative may be brought about by an action of the person represented, the previous representative or the new representative.

6.1 Action taken by the person represented

Rule 79 CTMIR

The person represented may at any time revoke, in a written and signed communication to the Office, the appointment of a representative or the authorisation granted to them. Revocation of an authorisation implies revocation of the representative's appointment.

Rule 76(6) CTMIR

Where the person represented declares the revocation to their representative and not to the Office, this will have no effect on any proceedings before the Office until the revocation is communicated to the Office. Where the party to the proceedings is obliged to be represented, paragraph 3.2 above will apply.

6.2 Withdrawal by the representative

The representative may at any time declare, by a signed communication to the Office, that they withdraw as a representative. The request must indicate the number of proceedings (e.g. CTM/RCD number, opposition etc.). If they declare that representation will as from that moment be taken over by another representative, the Office will record the change accordingly and correspond with the new representative. If the represented person is obliged to be represented, paragraph 3.2 above will apply.

7 Death or Legal Incapacity of the Party Represented or Representative

7.1 Death or legal incapacity of the party represented

Rule 76(7) CTMIR

In the event of the death or legal incapacity of the authorising party, the proceedings will continue with the representative, unless the authorisation contains provisions to the contrary.

Rule 73(1)(a) CTMIR

Depending on the proceedings, the representative will have to apply for registration of a transfer to the successor in title. However, the representative may apply for an interruption to the proceedings. For more information on the interruption of opposition

proceedings following death or legal incapacity, see the Guidelines, Part C, Opposition, Section 1, Procedural Matters.

For insolvency proceedings, once a liquidator has been nominated, they will assume the capacity to act on behalf of the bankrupt person and may, or in the case of mandatory representation must, appoint a new representative, or confirm the appointment of the existing representative.

For more information on insolvency proceedings, see the Guidelines, Part E, Register Operations, Section 3, CTMs as Objects of Property, Chapter 5, Insolvency Proceedings or Similar Proceedings.

7.2 Death or legal incapacity of the representative

Rule 73(1)(c) and (3)(a) and (b) CTMIR
--

In the event of the death or legal incapacity of a representative, the proceedings before the Office will be interrupted. If the Office has not been informed of the appointment of a new representative within a period of three months after the interruption, the Office will:

- where representation is not mandatory, inform the authorising party that the proceedings will now be resumed with them;
- where representation is mandatory, inform the authorising party that the legal consequences will apply, depending on the nature of the proceedings concerned (e.g. the application will be deemed to have been withdrawn, or the opposition will be rejected), if a new representative is not appointed within two months from the date of notification of that communication (decision of 28/09/2007, R 0048/2004-4, PORTICO, par. 13, 15).

Annex 1

COUNTRY	National terminology for legal practitioner	Entitlements/specific rules for representing clients in trade mark and design matters	National terminology for person with the special qualification – patent/trade mark/design attorney (the Office PROF REP)	Entitlements/specific rules for representing clients in trade mark and design matters
Austria	Rechtsanwalt	Lawyers are fully entitled	Patentanwalt	Notaries may represent third parties before the Austrian central industrial property office because of their special professional qualification. Therefore, notaries may apply to be entered on the list of professional representatives.
Belgium	Avocat, Advocaat, Rechtsanwalt	Lawyers are fully entitled but a person cannot be a lawyer and a professional representative at the same time.	In Dutch: Merkgemachtigde In French: Conseil en Marques/Conseils en propriété industrielle In German: Patentanwalt	Falls under the Benelux Treaty for Intellectual Property (Article 4.1). Any person having an address in Benelux territory may represent clients in IP matters. The entitlement is not conditional upon the need for special professional qualifications; persons applying to be entered on the list must have regularly acted as professional representatives for at least five years before a central industrial property office of a Member State.
Bulgaria	Адвокат/Практикуващ Право Advokat/Praktikuvash Pravo	Lawyers are not entitled	Spetsialist po targovski marki/Spetsialist po dizayni Специалист по търговски марки/Специалист по дизайни	Special professional qualification is required. The Bulgarian Patent Office is able to certify that someone has acted as representative for five years.
Croatia	Odvjetnik	Lawyers are fully entitled	Zastupnik Za Žigove	Special professional qualification is required. The 'authorised representative' is the person who passed an exam for TM representatives before the Croatian Office.

COUNTRY	National terminology for legal practitioner	Entitlements/specific rules for representing clients in trade mark and design matters	National terminology for person with the special qualification – patent/trade mark/design attorney (the Office PROF REP)	Entitlements/specific rules for representing clients in trade mark and design matters
Czech Republic	Advokát	Lawyers are fully entitled	Patentový zástupce	The Czech Republic has a two-part examination. Persons who have passed part B (trade marks and appellation of origin) may act as representatives in this field and hence be entered on the list of Article 93 CTMR. Patent attorneys, who have passed both parts of the examination, are entitled to represent applicants in all procedures before the Office.
Cyprus	Δικηγόρος Dikigoros	Lawyers ONLY are entitled	nihil	Not relevant.
Denmark	Advokat	Lawyers are fully entitled	Varemaerkefuldmaegtig	The entitlement is not conditional upon the need for special professional qualifications; persons applying to be entered on the list must have regularly acted as professional representatives for at least five years before a central industrial property office of a Member State.
Estonia	Jurist, Advokaat	Lawyers are not entitled unless dually qualified as IP agent.	Patendivolinik	The examination consists of two independent parts: on the one hand, patents and utility models and, on the other, trade marks, designs and geographical indications. Both types of representatives are 'patendivolinik'. Persons who have only passed the patents part of the examination may not be entered on the list of Article 93 CTMR. Entry on the list is open to persons who have passed the trade marks, industrial designs and geographical indications part.

COUNTRY	National terminology for legal practitioner	Entitlements/specific rules for representing clients in trade mark and design matters	National terminology for person with the special qualification – patent/trade mark/design attorney (the Office PROF REP)	Entitlements/specific rules for representing clients in trade mark and design matters
Finland	Asianajaja, Advokat	Lawyers are fully entitled	In Finnish: Tavaramerkkiasiamies In Swedish: Varumaerkesombud	As from 1 July 2014, the Finnish Patent Office will issue certificates to those professional representatives who comply with the conditions laid down in Article 93(2) CTMR to be entered in the list of professional representatives.
France	Avocat	Legal practitioners are entitled but a person cannot be a lawyer and a professional representative at the same time.	Conseil en Propriété Industrielle marques et modèles ou juriste.	<p>INPI maintains two different lists: The Liste des Conseils en propriété industrielle and the Liste des Personnes qualifiées en Propriété industrielle.</p> <p>Only persons on the 'Liste des Conseils en propriété industrielle' are entitled to represent third parties before the French Patent Office. Therefore, only these persons are entitled to be on the Office professional representatives list. These people appear on the block certificate.</p> <p>A 'Conseil en PI' is the person who works for an Association (Cabinet). The 'Personne qualifiée en PI' is the person who works for a private company (e.g. in the trade marks department). They are automatically switched from one list to the other in France.</p> <p>Since the 'personne qualifiée' acquired the same professional qualifications as the 'Conseils' they are entitled to apply for entry on our list, but they have to provide an individual certificate signed by the Directeur des Affaires Juridiques et Internationales.</p>

COUNTRY	National terminology for legal practitioner	Entitlements/specific rules for representing clients in trade mark and design matters	National terminology for person with the special qualification – patent/trade mark/design attorney (the Office PROF REP)	Entitlements/specific rules for representing clients in trade mark and design matters
Germany	Rechtsanwalt	Lawyers are fully entitled	Patentanwalt	A 'Patentassessor' is not qualified to act as a professional representative. He may act as an employee representative.
Greece	Δικηγόρος - Dikigoros	ONLY Lawyers are entitled	nihil	Not relevant.
Hungary	Ügyvéd	Legal advisers are not allowed to act as legal practitioners in procedures relating to industrial property matters. Therefore, they may not be entered on the Office's list of professional representatives.	Szabadalmi ügyvivő	A special professional qualification is required to be a patent attorney. Patent attorneys are entitled to represent clients in all procedures before the Office. Notaries are not allowed to act as legal practitioners in procedures relating to industrial property matters. Therefore, they may apply to be entered on the Office's list of professional representatives.
Ireland	Barrister, Solicitor	Lawyers are fully entitled	Trade mark agent	The person has to be entered in the Register of TM Agents.
Italy	Avvocato	Lawyers are fully entitled	Consulenti abilitati/Consulenti in Proprietà Industriale	The person has to be entered in the Register of 'Consulenti in Proprietà Industriale' ('Albo') kept by the Bar ('Consiglio dell'Ordine') and the register communicated to the Italian trade mark and patent office ('UIBM').

COUNTRY	National terminology for legal practitioner	Entitlements/specific rules for representing clients in trade mark and design matters	National terminology for person with the special qualification – patent/trade mark/design attorney (the Office PROF REP)	Entitlements/specific rules for representing clients in trade mark and design matters
Latvia	Advokāts	<p>Lawyers can only represent clients whose permanent residence is in the European Union.</p> <p>Clients whose permanent residence is not in the EU have to be represented by a professional representative.</p>	Patentu pilnvarotais/Preču zīmju aģents/Profesionāls patentpilnvarotais	<p>There is a trade mark examination.</p> <p>Clients whose permanent residence is not in the EU have to be represented by a professional representative.</p> <p>Notaries cannot act as representatives by right.</p>
Lithuania	Advokatas	<p>Lawyers can only represent clients whose permanent residence is in the European Union.</p> <p>Clients whose permanent residence is not in the EU have to be represented by a professional representative.</p>	Patentinis patikėtinis	<p>Clients whose permanent residence is not in the EU have to be represented by a professional representative.</p> <p>Notaries cannot act as representatives by right.</p>

COUNTRY	National terminology for legal practitioner	Entitlements/specific rules for representing clients in trade mark and design matters	National terminology for person with the special qualification – patent/trade mark/design attorney (the Office PROF REP)	Entitlements/specific rules for representing clients in trade mark and design matters
Luxembourg	Avocat/Rechtsanwalt	Lawyers are fully entitled but a person cannot be a lawyer and a professional representative at the same time.	In French: Conseil en Marques/Conseils en propriété industrielle In German: Patentanwalt	Falls under the Benelux Treaty for Intellectual Property (Article 4.1). Any person having an address in the Benelux territory may represent clients in IP matters. The entitlement is not conditional upon the need for special professional qualifications; persons applying to be entered on the list must have regularly acted as professional representatives for at least five years before a central industrial property office of a Member State.
Malta	Avukat, Prokuratur Legali	Lawyers are fully entitled .		Anyone with a legal background, including notaries, can act as a trade mark agent. No documentary proof of the qualification of legal practitioners acting as trade mark agents is required.
Poland	Adwokat, radca prawný	Lawyers are not fully entitled . The lawyer can only represent in opposition and cancellation (invalidity) proceedings.	Rzecznik Patentowy	The representative has to be on the list of patent attorneys maintained by the Polish Patent Office. In Poland, a trade mark attorney must be appointed for any proceeding other than opposition and cancellation. Trade mark attorneys must have passed the appropriate examinations.
Portugal	Avogado	Lawyers are fully entitled .	Agente Oficial da Propriedade Industrial	Five years' experience or special qualifications. A notary is not a legal practitioner and, therefore, may apply to be entered on the list.

COUNTRY	National terminology for legal practitioner	Entitlements/specific rules for representing clients in trade mark and design matters	National terminology for person with the special qualification – patent/trade mark/design attorney (the Office PROF REP)	Entitlements/specific rules for representing clients in trade mark and design matters
Romania	Avocat	Lawyers are not fully entitled.	Consilier în proprietate industrială	In Romania, three lists are maintained. Representatives are required to have special qualifications or five years' experience and be a member of a national chamber. A special professional qualification is required to be a professional representative.
Slovakia	Advokát, Komerčný Právník	Lawyers are fully entitled.	Patentový zástupca	In Slovakia, legal practitioners ('advokáts') listed in the Slovak BAR Association may act as representatives before the Industrial Property Office of the Slovak Republic.
Slovenia	Odvetnik	Lawyers are fully entitled.	Patentni zastopnik	Legal practitioners who are not entered in the Slovenian register as patent/trade mark agents are not allowed to represent parties before the Office. Notaries are not entitled by right.
Spain	Abogado	Lawyers are fully entitled.	Agente Oficial de la Propiedad Industrial	Entry on the list is conditional upon an examination.
Sweden	Advokat	Lawyers are fully entitled.	Patentombud	Entitlement is not conditional upon the need for special professional qualifications; persons applying to be entered on the list must have regularly acted as professional representatives for at least five years before a central industrial property office of a Member State.

COUNTRY	National terminology for legal practitioner	Entitlements/specific rules for representing clients in trade mark and design matters	National terminology for person with the special qualification – patent/trade mark/design attorney (the Office PROF REP)	Entitlements/specific rules for representing clients in trade mark and design matters
The Netherlands	Advocaat	Lawyers are fully entitled but a person cannot be a lawyer and a professional representative at the same time.	Merkengemachtigde	Falls under the Benelux Treaty for Intellectual Property (Article 4.1). Any person having an address on Benelux territory can represent clients in IP matters. The entitlement is not conditional upon the need for special professional qualifications; persons applying to be entered on the list must have regularly acted as professional representatives for at least five years before a central industrial property office of a Member State.
United Kingdom	Barrister, Solicitor, Registered Trade Mark Attorney	Lawyers are fully entitled .	Registered Trade Mark Attorney	Upon examination.

Annex 2

The list below shows the countries where a title exists for a person who is only entitled to represent in design matters. If the country is not on the list it means that the relevant entitlement also covers trade mark matters and so this person would not be on the special Design list.

COUNTRY	Design Attorney
Belgium	Modellengemachtigde, Conseil en modèles
Czech Republic	Patentový zástupce (the same denomination as trade mark agent)
Denmark	Varemaerkefuldmaegtig
Estonia	Patendivolinik
Finland	Mallioikeusasiamies/ Mönsterrättsombud
Ireland	Registered Patent Agent
Italy	Consulente in brevetti
Latvia	Patentpilnvarotais dizainparaugu lietas
Luxembourg	Conseil en Propriété Industrielle
Romania	Consilier de proprietate industrială
The Netherlands	Modellengemachtigde
United Kingdom	Registered Patent Agent

***GUIDELINES FOR EXAMINATION IN THE
OFFICE FOR HARMONIZATION IN THE
INTERNAL MARKET (TRADE MARKS AND
DESIGNS) ON COMMUNITY TRADE MARKS***

PART B

EXAMINATION

SECTION 2

FORMALITIES

1	Introduction	5
2	Filing of Applications	5
2.1	Applicants	5
2.2	Where a Community trade mark application can be filed	5
3	The Fees	5
3.1	Fees in general	5
3.2	Basic fee deficiency	6
3.3	Class fee deficiency	6
3.4	Fee refunds upon withdrawal	7
4	Filing Date	7
4.1	Filing date requirements	7
4.1.1	Fee	7
4.1.2	Request	8
4.1.3	Applicant	8
4.1.4	Representation of the mark	8
4.1.5	List of goods and services	8
4.2	Filing date receipt	9
4.2.1	Applications filed electronically	9
4.2.2	Applications received directly by the Office	9
4.2.3	Applications filed through national offices (intellectual property office of a Member State or Benelux Office)	9
5	Goods and Services	9
5.1	Classification	9
5.2	Specific formality deficiency for e-filing	10
6	Signature	10
7	Languages/Translations	11
7.1	First and second languages	11
7.2	The correspondence language	11
7.3	Reference language for translations	12
7.4	Translation of multilingual elements	12
7.5	Restriction of goods and services	14
8	Owner, Representative and Address for Correspondence	14
8.1	Applicant	14
8.2	Representative	15
8.3	Change of name/address	15
8.4	Transfer of ownership	15

9	Kind of Mark	16
9.1	Individual marks	16
9.2	Collective marks	16
9.2.1	Character of collective marks	16
9.2.2	Applicants for collective marks	16
9.2.3	Documents to be filed.....	17
9.2.4	Examination of formalities relating to collective marks.....	17
9.2.4.1	Regulations governing use not submitted.....	17
9.2.4.2	Regulations governing the use submitted but with deficiencies.....	17
9.2.5	Changes of the kind of mark (from collective to individual).....	17
10	Mark Type	18
10.1	Word marks	18
10.2	Figurative marks	19
10.3	Three-dimensional marks	21
10.4	Sound marks	23
10.4.1	Electronic sound file	24
10.4.2	Musical notations	24
10.4.3	Sonographs	24
10.5	Colour per se	25
10.6	Holograms	27
10.7	Smell/Olfactory marks	27
10.8	Other marks	27
10.8.1	Animated marks (movement)	27
10.8.2	Position marks	28
10.8.3	Tracer marks.....	30
10.9	Correction of the mark type	31
10.9.1	General rules	31
10.9.2	Examples of recurring mark type deficiencies.....	31
10.9.2.1	Word marks	31
10.9.2.2	Figurative marks.....	31
11	Series Marks	33
11.1	Multiple figurative representations	33
12	Indication of Colour	34
13	Mark Descriptions	36
14	Disclaimer	40
15	(Convention) Priority	41
15.1	Principle of first filing	43
15.2	Triple identity	44
15.2.1	Identity of the marks	44
15.2.2	Identity of the goods and services	44
Guidelines for Examination in the Office, Part B, Examination		Page 3

15.2.3 Identity of the owner	45
15.3 Priority requirements not satisfied	45
15.4 Priority documents not provided	45
15.5 Language of previous application.....	46
15.6 Priority date check after changing of the filing date.....	46
15.7 Examples of priority claims	46
15.7.1 First filing	46
15.7.2 Comparison of the marks	47
15.7.3 Comparison of the goods and services	51
15.7.4 Priority claims based on series marks.....	52
15.7.5 Claiming priority for three-dimensional or 'other' marks.....	53
15.7.6 Priority claims involving collective marks	53
16 Exhibition Priority.....	53
17 Seniority	54
17.1 Harmonised seniority information	54
17.2 Seniority examination	55
17.3 Identity of the marks	56
17.4 Goods and services	56
17.5 Treatment of seniority examination deficiencies	57
17.6 Examples of seniority claims.....	57
18 Transformation	58
19 Amendments to the CTM Application	58
19.1 Amendments to the representation of the mark.....	58
20 Conversion.....	60
Annex 1:	61
Required format for seniorities	61

1 Introduction

Every Community trade mark (CTM) application must abide by certain formality rules. The purpose of these Guidelines is to lay down Office practice in relation to those formality rules.

2 Filing of Applications

2.1 Applicants

Article 5 CTMR

Any natural or legal person, including authorities established under public law, may apply for a CTM, irrespective of their nationality or domicile.

2.2 Where a Community trade mark application can be filed

Article 25(1) CTMR
Rule 82 CTMIR
Decision EX-05-3 and EX-13-2 of the President of the Office

The applicant may file the application for a CTM directly with the Office, with the central industrial property office of a Member State or with the Benelux Office.

CTM applications may be sent to the Office electronically (through e-filing), by fax, by regular mail or private delivery services, or handed in personally at the Office's reception desk. If the user decides to file an application electronically, the Office offers the possibility of an accelerated procedure known as Fast Track (for more details please check the Office's website).

3 The Fees

Articles 2, 7 and 8 CTMFR
Article 27 CTMR
Rule 4 and Rule 9(5) CTMIR
Decision EX-96-1, amended in 1996, 2003 and 2006; Decision EX-13-2 of the President of the Office

3.1 Fees in general

For the application of a CTM the following fees are applicable:

Trade Mark	Basic Fee up to 3 Classes	Additional Class Fee
E-filed	EUR 900	EUR 150
Paper filed	EUR 1 050	EUR 150

Trade Mark	Basic Fee up to 3 Classes	Additional Class Fee
Collective	EUR 1 800	EUR 300

The fee must be paid in euros. Payments made in other currencies are not valid. There is no fee reduction for filing a collective mark electronically.

For more information on fees, see the Guidelines, Part A, General Rules, Section 3, Payments of Fees, Costs and Charges.

3.2 Basic fee deficiency

If the basic fee is not paid within one month from the date the Office received the application, the provisional filing date will be lost (see below under paragraph 4, Filing Date).

However, the filing date can be maintained if evidence is submitted to the Office that the person who made the payment (a) duly gave an order within the relevant period for payment to a banking establishment to transfer the amount of the payment, and (b) paid a surcharge of 10 % of the total amount due (up to a maximum amount of EUR 200).

The surcharge will not be due if the person submits proof that the payment was initiated more than 10 days before expiry of the one-month time limit.

3.3 Class fee deficiency

Where the application covers more than three classes of goods and/or services, an additional class fee is payable for each additional class.

- Where the fees paid or the amount covered by the current account is less than the total sum of fees due for the classes selected in the application form, a deficiency letter will be issued setting a two-month time limit for payment. If payment is not received within the time limit specified, the application will be deemed to be withdrawn for the classes not covered by the fee paid. In the absence of other criteria to determine which classes are intended to be covered by the amount paid, the Office will take the classes in the order of the classification (starting with the lowest).
- Where additional class fees become payable following the rectification of a classification deficiency, a deficiency letter will be issued setting a two-month time limit for payment. If payment is not received within the time limit specified, the application will be deemed to have been withdrawn for those classes resulting from the re-classification not covered by the fees actually paid. In the absence of other criteria to determine which classes are intended to be covered by the amount paid, the Office will take the classes in the order of the classification (starting with the lowest).

3.4 Fee refunds upon withdrawal

On withdrawal of the CTM application the application fee (basic and class fees) will only be refunded in certain circumstances.

For more information on this see the Guidelines, Part A, General Rules, Section 3, Payment of Fees, Costs and Charges.

4 Filing Date

Article 25(3), Articles 26 and 27 CTMR Rule 9(1) CTMIR

4.1 Filing date requirements

A filing date is accorded where the application fulfils the following requirements:

- the application fee has been paid;
- the application is a request for the registration of a CTM;
- the application contains information to identify the applicant;
- the application contains a representation of the trade mark;
- the application contains a list of goods/services.

If any of the above requirements are not met, a deficiency letter will be sent out requesting the applicant to provide the missing item within two months of the notification of the deficiency letter. This time limit is not extendable. If the deficiency is not remedied, the CTM application will be 'deemed not filed' and all fees already paid will be reimbursed. If the missing information is provided within the time limit set in the deficiency letter, the filing date will be changed to the date on which all mandatory information is complete, including the payment.

In some cases, applicants file more than one representation of the mark (in this context see below under paragraph 10.3, Three-dimensional marks and paragraph 11, Series Marks). As the application does contain a representation of the mark, this is not to be considered a filing-date deficiency. Rather, the applicant is required to indicate which of the representations filed should be used as the representation of the CTM application; this should be done via a deficiency letter, and the Office will set a two-month time limit for the applicant to specify the correct representation.

4.1.1 Fee

Article 26(2) CTMR Rule 4 and Rule 9(1)(b) CTMIR

The basic fee and, where appropriate, class fees, must be paid within one month of the filing of the application. Where the fee is not paid within one month the Office will issue a deficiency letter (see paragraph 3.2 above).

4.1.2 Request

Article 26(1)(a) CTMR
Rule 1(1)(a), Rule 9(1)(a)(i) and Rule 83(1)(e) CTMIR

The application must contain a request for the registration of a CTM.

It is strongly recommended that the CTM application is filed using the Office's e-filing form, available in the official languages of the European Union. Forms are also made available to the public, free of charge and in all the official languages of the European Union.

4.1.3 Applicant

Article 26(1)(b) CTMR
Rule 1(1)(a) and Rule 9(1)(a)(ii) CTMIR

The application must contain information identifying the applicant, specifically: the name, address and nationality of the applicant and the State in which it is domiciled or has its seat or an establishment. If the applicant has previously been allocated an ID number by the Office, it is sufficient to indicate that ID number and the applicant's name.

4.1.4 Representation of the mark

Article 26(1)(d) CTMR
Rule 1(1)(d), Rule 3 and Rule 9(1)(a)(iv) CTMIR

The application must contain a representation of the mark in accordance with Rule 3 CTMIR. For further information on the different types of marks, please see paragraph 10 below.

4.1.5 List of goods and services

Article 26 and Article 43(2) CTMR
Rule 1(1)(c), Rule 2 and Rule 9(1)(a)(iii) CTMIR

The presence of a list of goods and services is a filing-date requirement. A reference in the respective field of the CTM application form to a previous CTM may be used to indicate the list of goods and services.

For applications filed electronically, please also see paragraph 5.2 below.

4.2 Filing date receipt

4.2.1 Applications filed electronically

For electronically filed CTM applications, the system issues an immediate automatic electronic filing receipt, which contains the provisional filing date. The applicant should save or print this receipt.

4.2.2 Applications received directly by the Office

When an application is received by the Office by any other means than electronically (see paragraph 4.2.1 above), a provisional filing date is accorded and the Office issues a receipt with this filing date. The filing date will be considered the reception date if the application fulfils the filing date requirements (see paragraph 4.1 above).

4.2.3 Applications filed through national offices (intellectual property office of a Member State or Benelux Office)

If a CTM application is filed with the central industrial property office of a Member State or with the Benelux Office for Intellectual Property, it will have the same effect as if it had been filed with the Office on that same day, provided that it is received by the Office within two months from the date it was filed at the national office.

If the CTM application does not reach the Office within two months, it will be deemed to have been filed on the date that it is received by the Office.

5 Goods and Services

5.1 Classification

Every CTM application must contain a list of goods and services as a condition for according a filing date (see paragraph 4.1.5 above).

The list must be classified in accordance with the Nice Agreement (Article 28 CTMR and Rule 2(1) CTMIR).

The scope of protection defined by the original list of goods and services cannot be extended. If an applicant wants to protect additional goods or services after filing, a new application must be filed.

For further information on the classification of goods and services please refer to the Guidelines, Part B, Examination, Section 3, Classification.

5.2 Specific formality deficiency for e-filing

Rule 82(1) and Rule 9(3)(a) and Rule 9(4) CTMIR
Decision EX-13-2 of the President of the Office of 26 November 2013 concerning electronic communication with and by the Office ('Basic Decision on Electronic Communication')

Applications filed electronically are subject to the terms and conditions concerning electronic communication with and by the Office within the User Area as established in Decision EX-13-2 (Basic Decision on Electronic Communication).

For applications filed electronically, the list of goods and services must be entered in the text fields provided for that purpose. Lists of goods and services filed as an attachment to the e-filing application, or filed separately, will not be considered to comply with the terms and conditions concerning electronic communication with and by the Office.

In such cases the Office will issue a deficiency letter requesting the payment of the difference between the reduced basic fee for applications filed by electronic means and the standard basic fee, that is to say, EUR 150.

If the deficiency is not remedied within the period set by the Office in its notification, the application will be deemed to have been withdrawn for the goods and services that were filed as an attachment to the application form or separately. If there are no goods and services entered in the text fields provided, and the deficiency is not remedied, the application will be refused.

This specific formality deficiency will not apply to collective marks.

Where available, a reference in the respective field of the CTM application form to a previous CTM may be used to indicate the list of goods and services. In this case, the list of goods and services will be imported automatically.

6 Signature

Rules 80(3) and 82(3) CTMIR

Application forms lodged by fax, post, private delivery service or personal delivery must be signed either on the form itself or on an accompanying letter. The signature may be that of the applicant or the representative. If an application communicated to the Office is not signed, the Office will invite the party concerned to correct the irregularity within a two-month time limit. If the deficiency is not remedied within the time limit, the application will be rejected.

If an application is filed electronically, the indication of the name of the sender is deemed to be equivalent to a signature.

7 Languages/Translations

Articles 119 and 120 CTMR
Communication 4/04 of the President of the Office

A CTM application may be filed in any of the official languages of the European Union. A second language must be indicated on the application form, which must be one of the five languages of the Office, namely, English, French, German, Italian or Spanish.

A different language version of the application form from the language chosen as the first language may be used. However, the application form must be completed in that first language, including the list of goods and services, indication of colour(s), mark description and disclaimer, where appropriate.

7.1 First and second languages

All information on the application form must be in the first language; otherwise, a deficiency letter is sent. If the deficiency is not remedied within two months, the application will be rejected.

The second language serves as a potential language for opposition and cancellation proceedings. The second language must be different from the language selected as the first language. Under no circumstances can the choice of first and second language be changed once filed.

When filing the application, the applicant may choose to provide a translation into the second language of the list of goods and services and, where relevant, any mark description, disclaimer and colour indication. Where such a translation is submitted on its own motion, the applicant is responsible for ensuring that the translation corresponds to the first language. It is very important for the applicant to ensure the accuracy of the translation as, in particular, the translation submitted by the applicant may be used as the basis for the translation of the application into all the remaining languages of the European Union (see paragraph 7.3, Reference language for translations below). In the case of any discrepancy, the question as to which language version prevails depends on whether the first language is one of the five Office languages or not. If the first language of the application is one of the five Office languages, the first language version prevails. If the first language of the application is not one of the five Office languages, the second language prevails.

7.2 The correspondence language

The correspondence language is the language used in correspondence between the Office and the applicant in examination proceedings until registration of the mark.

If the language that the applicant has selected as the first language is one of the five languages of the Office, then this will be used as the correspondence language.

Only where the language selected as the first language is not one of the five Office languages can the applicant indicate that it wants the correspondence language to be the second language. This request can be made on the application form by ticking the respective box or can be requested later on, either by explicit request, or implied by

sending a communication to the Office in the second language. However, such a request will be refused where the Office has already issued a deficiency or objection letter in the first language.

In cases where the applicant selects one of the five Office languages as the first language but then indicates that the second language is to be the correspondence language, the Office will change the correspondence language to the first language and inform the applicant.

Example		
First language selected	Second language selected	Correspondence language selected
French	English	English
The correspondence language will be changed to French.		

For more information on languages, please refer to the Guidelines, Part A, General Rules, Section 4, Language of Proceedings.

7.3 Reference language for translations

The list of goods and services are translated into the official languages of the EU. The source language for translations is defined as the reference language. If the first language of the application is one of the five Office languages, it will always be the reference language.

If the first language of the application is not one of the five Office languages and the applicant has submitted a translation of the goods and services in the second language, the reference language will be the second language. If no translation is submitted, the first language will be the reference language.

7.4 Translation of multilingual elements

Multilingual elements contain information on the application that needs, in principle, to be translated. These elements are mark descriptions, colour indications and disclaimers.

If a translation of goods and services is supplied in the second language, the Office will check that all relevant multilingual elements (mark description, colour indication, disclaimer) have also been translated; However, the accuracy of the translation will not be checked by the Office. If the applicant has only submitted a partial translation, a deficiency letter will be sent to the applicant, requesting that the additional translations be submitted within two months from notification of the deficiency. If the applicant fails to submit the omitted translations, then all translations submitted by the applicant will be disregarded and the Office will proceed as if no translation had been submitted. Translations of simple colours will be added by the Office.

Before sending the application for translation, the Office will ensure that the information contained in the multilingual elements is correct and acceptable. The details can be seen below in the relevant paragraphs on colour indications, mark descriptions and disclaimers (paragraphs 12, 13 and 14 respectively). Furthermore, before requesting

translation of an application, ‘non-translatable elements’ will be identified as such by putting them into inverted commas (“”), as agreed as a formatting rule with the Translation Centre for the Bodies of the European Union (CdT).

The following elements are **not** to be translated and will be put into inverted commas:

1. mark descriptions: where the acceptable mark description refers to a verbal element of the mark, this element should not be translated:

Mark description	Mark
<p>CTM 10 003 317</p> <p>The word “Rishta” in a stylised script on a diamond-shaped background with a shadow effect and the words “Premium Quality” in a smaller font on a rectangular block positioned above the word “Rishta” and below the upper point of the diamond shape.</p>	

(For information on the examination of mark descriptions see paragraph 13 below.)

2. colour indications: where the colour indication includes a reference to an international coding system (e.g. “Pantone”), this must be identified with inverted commas, as it should not be translated:

Colour indication	Mark
<p>CTM 10 171 452</p> <p>Blå (“Pantone 3115”), Grå (“Cool Grey 9”).</p>	

(For information on the examination of colour indications see paragraph 12 below.)

3. disclaimers: if a word element of the mark is disclaimed, this word element should be identified with inverted commas, as it must not be translated:

Disclaimer	Mark
<p>“socks”</p>	<p>DOODAH SOCKS</p>

(For information on the examination of disclaimers see paragraph 14 below.)

7.5 Restriction of goods and services

Article 43(2) CTMR
Rule 95(a) CTMIR

If the first language of the CTM application is one of the five Office languages, a restriction in examination proceedings can only be accepted in the first language of the application.

In cases where the first language of the application is not one of the five Office languages, a restriction in examination proceedings can only be accepted in the second language if the second language has been indicated as the correspondence language.

Example of acceptable restriction request	
First language NL	Second language EN
A restriction sent to the Office in English would be accepted provided that English has been indicated as the correspondence language of the application.	

Example of unacceptable restriction request	
First language IT	Second language EN
A restriction sent to the Office in English would not be accepted, as in this case Italian is one of the five languages of the Office and is therefore the only language in which a restriction will be accepted.	

8 Owner, Representative and Address for Correspondence

Articles 3, 5 and 92 CTMR
Rule 1(1)(b), Rules 26 and 76 CTMIR

8.1 Applicant

Any natural or legal person, including authorities established under public law (e.g. a university) may be the proprietor of a CTM. Filings in the name of a legal entity in the process of foundation will be accepted.

In a CTM application the applicant must state its name, address, nationality and the State in which it is domiciled or has its seat or establishment. The Office strongly recommends indicating the State of Incorporation for US companies, where applicable, in order to differentiate clearly between different owners in its database. Names of natural persons must be indicated by the person's family name and given name(s). The names of legal entities must be given in full and only its legal forms may be abbreviated in a customary manner, for example, PLC, S.A. If the legal form is not specified or is incorrectly indicated, a deficiency letter requesting this information will be issued. If the missing or the correct legal form is not given, the application will be rejected.

The address should contain, if possible, the street, street number, city/town or state/county, postal code and country. The applicant should indicate only one address,

but if there are several the first one listed will be recorded as the address for service, unless the applicant specifically designates a different one.

If the applicant has been given an ID number by the Office in a previous case, it will be sufficient for it to indicate that number together with the name of the applicant.

For more information on communication with the Office, please refer to the Guidelines, Part A, General Rules, Section 1, Means of Communication, Time Limits.

8.2 Representative

If the applicant has its domicile, principal place of business or a real and effective industrial or commercial establishment in the EU, there is no obligation for it to be represented.

If the applicant does not have its domicile, principal place of business or a real and effective industrial or commercial establishment in the EU, regardless of its nationality, representation must be sought to act for it in all proceedings except the filing of the CTM application and the payment of the application fee. Every representative in the sense of Article 93 CTMR who files an application with the Office is placed on the Representative database and given an ID number. If the representative has been allocated an identification number by the Office, it is sufficient to indicate only that ID number and the name.

For more information on representation, see the Guidelines, Part A, General Rules, Section 5, Professional Representation.

8.3 Change of name/address

The name and address of the applicant may be amended. A change in the name of the applicant is a change that does not affect the identity of the applicant, whereas a transfer is a change in the identity of the applicant. For more information on the definition of a change of name and its comparison to a transfer, see the Guidelines, Part E, Register Operations, Section 3, CTMs as Objects of Property, Chapter 1, Transfer.

8.4 Transfer of ownership

Article 17(5), Articles 24 and 87 CTMR Rule 31(8) and Rule 84(3)(g) CTMIR
--

CTM registrations and applications may be transferred from the previous proprietor/applicant to a new proprietor/applicant, primarily by way of assignment or legal succession. The transfer may be limited to some of the goods and/or services for which the mark is registered or applied for (partial transfer). Upon request, transfers of registered CTMs are entered in the Register and transfers of CTM applications are noted in the files.

For more information on the recording of transfers of ownership see the Guidelines, Part E, Register Operations, Section 3, CTMs as Objects of Property, Chapter 1, Transfer.

9 Kind of Mark

The CTM regulation distinguishes between two kinds of marks: individual and collective.

9.1 Individual marks

Article 5 CTMR

Any natural or legal person, or person equivalent to these persons under the national law applicable to them, including authorities established under public law, may be the proprietor of a Community individual trade mark, irrespective of their nationality.

9.2 Collective marks

Articles 66 to 68 CTMR Rules 3 and 43 CTMIR
--

9.2.1 Character of collective marks

A collective mark is a specific type of trade mark that indicates that the goods or services bearing that mark originate from members of an association, rather than from just one trader. Collective does not mean that the mark belongs to several persons (co-applicants/co-owners) nor that it designates/covers more than one country.

Collective marks can be used to publicise products that are characteristic of a particular region, and may be used together with the individual mark of the producer of a given good. This allows members of an association to differentiate their own products from those of competitors.

For further information as to the substantive requirements of Community collective marks see the Guidelines, Part B, Examination, Section 4, Absolute Grounds for Refusal and Community Collective Marks.

9.2.2 Applicants for collective marks

Associations of manufacturers, producers, suppliers of services, or traders that under the terms of the law governing them have the capacity in their own name to have rights and obligations of all kinds, to make contracts or accomplish other legal acts and to sue or be sued, as well as legal persons governed by public law, may apply for a collective mark. There are essentially two criteria to be met. Firstly, the applicant must be an association or a public body and secondly it must exist as an entity in itself.

For further information as to the substantive requirements of Community collective marks please see the Guidelines, Part B, Examination, Section 4, Absolute Grounds for Refusal and Community Collective Marks.

9.2.3 Documents to be filed

In addition to the information to be filed when applying for an individual trade mark, applications for a Community collective trade mark require regulations governing use of the mark. These regulations must specify:

1. the name of the applicant and its office address;
2. the object of the association or the object for which the legal person governed by public law is constituted;
3. the bodies authorised to represent the association or the said legal person;
4. the conditions for membership;
5. the persons authorised to use the mark;
6. where appropriate, the conditions governing use of the mark, including sanctions;
7. if the mark designates the geographical origin of goods or services, authorisation for any person whose goods or services originate in the geographical area concerned to become a member of the association.

9.2.4 Examination of formalities relating to collective marks

9.2.4.1 Regulations governing use not submitted

If the regulations are not submitted with the application, a deficiency letter will be sent, setting a time limit of two months to provide them.

If the regulations are not submitted within this two-month time limit, the application will be rejected

9.2.4.2 Regulations governing the use submitted but with deficiencies

If the regulations have been submitted but fail to specify the required information as listed in paragraph 9.2.3 above, a deficiency letter will be sent, setting a time limit of two months to provide the missing information.

If the deficiency is not remedied within this two-month time limit, the application will be rejected.

9.2.5 Changes of the kind of mark (from collective to individual)

If a natural person has applied for a collective mark by mistake, that is to say, they have erroneously entered/selected the kind of mark as 'collective' on the application form, they may change the mark from collective to individual, since collective marks cannot be granted to natural persons. The fee surplus will also be refunded.

Where a legal person claims to have applied for a collective mark by mistake, the amendment will also be allowed and the fee surplus refunded. However, the filing of a collective mark would not be seen as an obvious error, and the amendment request

would be rejected, where there are indications that the applicant intended to apply for this kind of mark, for example:

- the mark representation includes the words 'collective mark'; or
- the name of the applicant states that it is an association; or
- regulations of use of the collective mark are submitted.

10 Mark Type

Articles 4 and 26, Article 7(1)(a) CTMR Rule 3 CTMIR

The categorisation of marks serves a number of functions. Firstly, it establishes the legal requirement for the mark to be represented; secondly, it can help the Office understand what the applicant is seeking to register; and finally, it facilitates research in the Office database.

A trade mark may consist of any sign capable of being represented graphically. It is a requirement of filing that there is a representation of the mark on the application form. The mark must be represented graphically and this representation cannot be replaced by a description of the mark. If the applicant fails to graphically represent its mark, a deficiency letter is sent and a filing date will not be recorded (see paragraph 4 above, Filing Date).

Where the application contains a representation of the mark without specifying the desired mark type, the Office will, based on the representation provided and any mark description, accord the appropriate mark type and inform the applicant in writing, setting a two-month time limit for observations.

Where the applicant has selected a mark type that does not correspond to the mark representation, together with any mark description provided, the mark type will be corrected following the indications set out below under paragraph 10.9, Correction of the mark type.

The examples of mark types in these Guidelines are given only in the context of formalities' issues without prejudice to the outcome of the examination proceedings.

Verbal elements consist of letters in the alphabet of any official EU language and keyboard signs. Where a mark, other than a word mark, contains any such verbal element that is visible from the representation, it must be included in the respective field. This allows for the mark to be searched for within the database and also forms the basis of the language check for marks that is carried out in all official languages of the EU.

10.1 Word marks

A word mark is a typewritten mark with elements including letters (either lower or upper case), words (either in lower or upper case letters), numerals, keyboard signs or punctuation marks written across a single line. The Office accepts the alphabet from any official EU language as a word mark. A mark consisting of text written across more

than one line will not be categorised as a word mark, as these marks are considered to be figurative.



Examples of acceptable word marks (for formalities' purposes)	
CTM 6 892 351	europadruck24
CTM 6 892 806	TS 840
CTM 6 907 539	4 you
CTM 2 221 497	ESSENTIALFLOSS
CTM 0 631 457	DON'T DREAM IT, DRIVE IT
CTM 1 587 450	?WHAT IF!
CTM 8 355 521	ΕΙΔ ΕΛΛΗΝΙΚΟ ΙΝΣΤΙΤΟΥΤΟ ΔΙΑΤΡΟΦΗΣ (Greek)
CTM 8 296 832	Долината на тракийските царе (Cyrillic)

10.2 Figurative marks

A figurative mark is a mark consisting of:

- exclusively figurative elements;
- a combination of verbal and figurative or otherwise graphical elements;
- verbal elements in non-standard fonts;
- verbal elements in colour;
- verbal elements on more than one line;
- letters from non-EU alphabets;
- signs that cannot be reproduced by a keyboard;
- combinations of the above.

Marks depicting a pattern are 'figurative' marks in accordance with Office practice.

Examples of figurative marks (for formalities' purposes)	
<p>CTM 1 414 366</p> <p>Purely graphic element with no colour</p>	
<p>CTM 9 685 256</p> <p>Purely graphic element in colour</p>	
<p>CTM 4 705 414</p> <p>Combination of graphic element and text in standard font, no colour</p>	

Examples of figurative marks (for formalities' purposes)	
<p>CTM 9 687 336</p> <p>Combination of stylised font and figurative elements, no colour</p>	
<p>CTM 4 731 725</p> <p>Combination of stylised font and figurative elements in colour</p>	
<p>CTM 9 696 543</p> <p>Verbal element in stylised font with no colour</p>	
<p>CTM 2 992 105</p> <p>Verbal elements in stylised font with no colour</p>	
<p>CTM 9 679 358</p> <p>Verbal elements in different fonts in colour</p>	
<p>CTM 9 368 457</p> <p>Verbal elements only, over more than one line</p>	
<p>CTM 9 355 918</p> <p>Slogan in two different fonts, letters in different sizes, on more than one line, and in colour</p>	
<p>CTM 9 681 917</p> <p>Verbal element in non-EU alphabet (Chinese)</p>	
<p>CTM 0 015 602</p> <p>Pattern</p>	

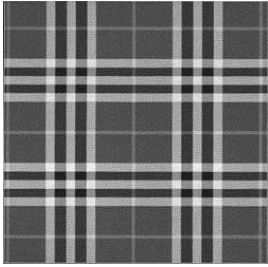
Examples of figurative marks (for formalities' purposes)	
CTM 7 190 929 Pattern	

10.3 Three-dimensional marks

Article 43(2) CTMR; Rule 3(4) CTMIR
 Communication 2/98 of the President of the Office

A three-dimensional mark is a mark consisting of a three-dimensional shape (including containers, packaging and the product itself). The photographic or graphic representation may consist of up to six perspectives of the same shape that must be submitted in one single JPEG file in the case of e-filed applications or on one single A4 sheet in the case of paper-filed applications. While up to six perspectives may be filed, a single view of the shape is sufficient where the shape to be protected can be ascertained from that single view.



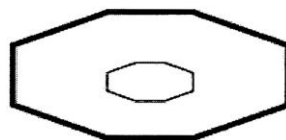

In some cases, applicants file different perspectives of a three-dimensional object on several sheets of paper (e.g. one page per picture/perspective). In such a case, a deficiency should be raised, setting a time limit for the applicant to indicate which of the representations filed should be used as the representation of the CTM application.

Applicants applying for registration of a three-dimensional mark must make a corresponding indication in the application. If no mark type is indicated and only one view of the object has been provided and the mark description — if any — does not say that the mark filed is three-dimensional, the Office will treat it as a figurative trade mark.

Example

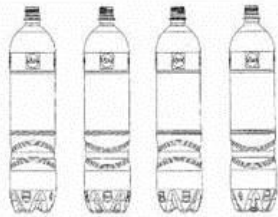

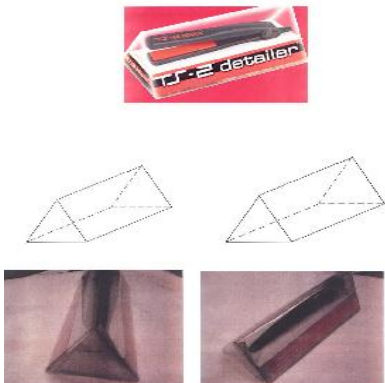

No mark type was selected for this sign and no mark description was provided. The Office will treat this as a figurative mark.

Examples of acceptable representations of three-dimensional marks (for formalities' purposes)	
<p>CTM 4 883 096</p> <p>Four different drawings of the same object</p>	
<p>CTM 4 787 693</p> <p>Six photographs of the same object from different perspectives, with text</p>	
<p>CTM 30 957</p> <p>Two photographs in colour showing different perspectives of the same object</p>	
<p>CTM 8 532 475</p> <p>Six views in colour showing six different perspectives of the same object</p>	

Examples of marks that are not acceptable as three-dimensional marks (for formalities' purposes)	
<p>CTM 6 910 021</p> <p>Five views, but not showing the same object</p>	

Examples of marks that are not acceptable as three-dimensional marks (for formalities' purposes)

<p style="text-align: center;">CTM 7 469 661</p> <p>No text in addition to the representation of the mark is allowed (text below the photo of the bottle)</p>	
<p style="text-align: center;">CTM 9 739 731</p> <p>The first and third bottles show two different perspectives of the same bottle, both with a grey lid. The second bottle has a blue lid, and is therefore a different object to those pictured in the first and third bottles. The fourth image is completely different, showing two bottle tops and a label. Of the four perspectives, only the first and third are views of the same object.</p>	

Where the views filed for the application of a three-dimensional CTM consist of different objects depicted on a single sheet of A4 paper or in one JPEG file, the deficiency cannot be remedied since the deletion of one or more of these different objects would mean a considerable alteration of the mark representation (see below under paragraph 19, Amendments to the CTM Application). In this case, the application must be rejected as the representation does not show a single three-dimensional shape.

10.4 Sound marks

Article 4 CTMR; Decision EX-05-3 of the President of the Office

A sound mark must be represented graphically using the standard methods for reproducing sound graphically, in particular musical notation. A description of the sound in words is not sufficient (decision of 27/09/2007, R 0708/2006-4, TARZAN YELL). The lyrics of a song combined with musical notations and the tempo is acceptable. A sonograph alone is not an acceptable graphical representation of a sound mark if it is not accompanied by an electronic file containing the sound. Where the sound applied for cannot be depicted in conventional musical notation, for example the roar of a lion, a sonograph together with a sound file is the only means of representing the mark.

10.4.1 Electronic sound file

The attachment of an MP3 sound file is optional where musical notation has been provided and this is only possible in e-filings. The Office will not accept the filing of an electronic sound file on its own, since a graphical representation is required. Where an application does not include a graphic representation of the mark, a filing date deficiency will be raised (for more information on filing dates, see paragraph 4 above).



The sound file must be in MP3 format and its file size cannot exceed two megabytes. Office requirements do not allow the sound to stream or loop. Any other attachments or attachments that do not comply with these criteria will be deemed not to have been filed.

10.4.2 Musical notations

The applicant may file musical notation alone. This will satisfy the requirement for graphically representing the mark. In these cases an electronic sound file may be attached but it is not mandatory.

10.4.3 Sonographs

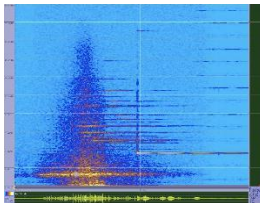
The applicant cannot file a sonograph alone (decision of 27/09/2007, R 0708/2006-4, TARZAN YELL). In these cases an electronic sound file is mandatory, since the Office and third parties cannot deduce the sound from the sonograph alone. Any colours used in a sonograph are not part of the mark, as the applicant is applying for a sound mark. Therefore, no colour indication is to be recorded and where such indication is provided, it will be deleted by the Office.

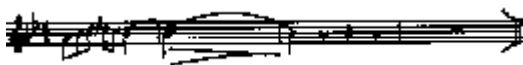
Examples of acceptable sound marks (for formalities' purposes)	
<p>CTM 8 116 337</p> <p>Sonograph that was accompanied by a sound file</p>	
<p>CTM 9 199 134</p> <p>Sonograph that was accompanied by a sound file</p>	
<p>CTM 1 637 859</p> <p>Musical notation</p>	

Examples of acceptable sound marks (for formalities' purposes)	
CTM 6 596 258 Musical notation including musical directions	





10.5 Colour per se

Colour per se means that trade mark protection is sought for one or several colours, regardless of any specific shape or configuration. What is protected is the shade of colour(s) and, in the case of more than one colour, the ratio and position of the various colours, which must be systematically arranged by associating them in a predetermined and uniform way (judgments of 24/06/2004, C-49/02, Blau/Gelb, EU:C:2004:384, § 33 and 14/06/2012, T-293/10, Colour per se, EU:T:2012:302, § 50). The representation of a colour per se mark must consist of a representation of the colour or colours without contours. Where there is more than one colour, the proportion of each colour must be specified in the mark description field. If this has not been done in the application, the Office will notify the deficiency, allowing two months for the information to be provided.

If the representation contains other matter, such as words or images, it is not a colour per se mark but a figurative mark. For information on correction of the mark type, see paragraph 10.9 below.

When applying for a colour per se mark, the provision of a mere sample of the colour on its own is not sufficient; the colour or colours that are the subject of the mark must be described in words in the 'Indication of Colour(s)' field. Furthermore, it is highly recommended also to provide internationally recognised colour codes (judgment of 06/05/2003, C-104/01, Libertel, EU:C:2003:244, § 31-38). For more on indication of colour see paragraph 12 below.

Pursuant to Rule 3(3) CTMIR, an application for a colour per se mark may be represented by showing the colour or colours as they will be applied to the goods and services concerned. In such cases, a mark description is required in order to clarify the nature of the mark.

Examples of acceptable colour per se marks (for formalities' purposes)	
<p style="text-align: center;">CTM 962 076</p> <p><u>Colour indicated:</u> Brown</p>	
<p style="text-align: center;">CTM 31 336</p> <p><u>Colour indicated:</u> Lilac/violet</p> <p><u>Description:</u> Lilac/violet, single colour as shown in the representation. The values (specific coordinates in the colour space) for the present mark are: L => 53,58 /- 08; A => 15,78 /- 05; B => 31,04 /- 05. The mark can be located in Pantone's Process Book between the shades with number E 176-4 and E 176-3.</p>	
<p style="text-align: center;">CTM 8 298 499</p> <p><u>Colours indicated:</u> Green, Pantone 368 C, anthracite, Pantone 425 C, orange, Pantone 021 C</p> <p><u>Description:</u> The trade mark consists of the colours green: Pantone 368 C; anthracite: Pantone 425 C; orange: Pantone 021 C, as shown in the illustration; the colours are applied to a basic component of the exterior of vehicle service stations (petrol stations) in the ratio green 60 %, anthracite 30 % and orange 10 %, creating the impression of a green and anthracite-coloured petrol station (green predominating) with small orange accents.</p>	
<p style="text-align: center;">CTM 4 381 471</p> <p><u>Colours indicated:</u> Blue (Pantone 2747 C) and silver (Pantone 877 C)</p> <p><u>Description:</u> Protection is claimed for the colours blue (Pantone 2747 C) and silver (Pantone 877 C) juxtaposed as shown in the representation of the colour mark applied for. The ratio of the colours is approximately 50 %-50 %.</p>	
<p style="text-align: center;">CTM 11 055 811</p> <p><u>Colours indicated:</u> Very light green, light green, medium green, dark green, very dark green</p> <p><u>Description:</u> The mark consists of five stripes of colours positioned horizontally directly one above the other, their length being several times larger than their height. The colour distribution from the top to the bottom is the following: very light green, light green, medium green, dark green and very dark green. Proportion of the five colours: 20 % each.</p>	

10.6 Holograms

Holograms are particularly difficult to represent graphically since a paper representation does not allow the image to 'change' as it would naturally on holographic paper. However, with a clear mark description and sufficient views of the mark, a hologram can be graphically represented. Therefore, where a hologram is applied for, more than one mark representation can be filed, provided all different views are on a single A4 sheet in the case of paper filings or in a single JPEG file in the case of e-filing.

10.7 Smell/Olfactory marks

Smell or olfactory marks are not currently acceptable. This is because a graphic representation must be clear, precise, self-contained, easily accessible, intelligible, durable and objective (judgment of 12/12/2002, C-273/00, Methylcinnamat, EU:C:2002:748). As in the case of all the other types of marks, a mark description cannot replace the graphic representation. Although it may be graphic, a description of a smell is neither clear, precise nor objective and therefore no filing date can be attributed because the mark cannot be graphically represented. Such cases (decision of 04/08/2003, R 0120/2001-2, The taste of artificial strawberry flavour) will not be rejected but rather deemed not filed. Where a purported graphic representation is filed, the application will be refused under absolute grounds for refusal (see the Guidelines, Part B, Examination, Section 4, Absolute Grounds for Refusal).

10.8 Other marks

Other marks must contain an indication in the mark description of what is meant by 'other'. 'Other' marks can be, for example, animated marks (movement marks), position marks or tracer marks (coloured stripes or threads applied to certain products).



For more information refer to the Guidelines, Part B, Examination, Section 4, Absolute Grounds for Refusal.

10.8.1 Animated marks (movement)

The number of mark representations is practically unlimited as long as they are all on a single A4 sheet in the case of paper filings, or in a single JPEG document in the case of e-filing. As the applicant's aim is to protect the specific movement of the mark, a mark description indicating that it is a 'movement mark' is a formality requirement.

The representations together with the mark description must clearly explain the movement that is to be protected. Where the movement cannot be perceived (e.g. the representations are out of sequence), or the mark description does not match the sequence of representations, the Office will issue a deficiency allowing two months for the representations and/or description to be clarified. If the deficiency is not remedied within the time limit, the application will be rejected.

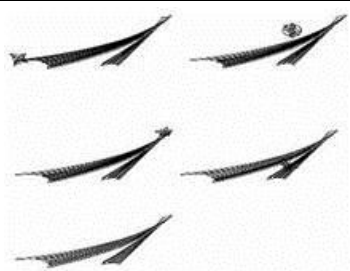
Where the representations include colour, the colour(s) used must be indicated in words.

Examples of acceptable animated marks (movement) (for formalities' purposes)	
<p style="text-align: center;">CTM 5 338 629</p> <p><u>Description:</u> The mark is an animated sequence with two flared segments that join in the upper right portion of the mark. During the animation sequence, a geometric object moves up adjacent to the first segment and then down adjacent to the second segment, while individual chords within each segment turn from dark to light. Stippling down in the mark is for shading only. The entire animated sequence lasts between one and two seconds.</p>	 <p><u>Representations:</u> Mark representation in black and white and shades of grey only; no colour indication.</p>
<p style="text-align: center;">CTM 13 225 107</p> <p><u>Description:</u> All of the representations are on a white surface. At the outset only the text 'Hotel?' is readable on the white background. This text is in blue, yellow and red. The characters are divided into pairs of characters, with each pair being in a single colour. The entirety of the text is tilting forwards towards the viewer. As a result of the rotation, the previous text 'Hotel?' turns into 'trivago'. This text has the same colours (blue, yellow and red) as the previous text.</p> <p>Colours: Blue, red, black, white, yellow.</p>	

10.8.2 Position marks

A position mark is a sign positioned on a particular part of a product in a constant size or particular proportion to the product. The sign must be represented graphically. As the applicant is aiming to protect the placement or 'position' of the mark, a mark description detailing its positioning is a formality requirement. The mark description must also contain an indication that it is a 'position mark' and, where a representation in colour is submitted, the colour(s) used must be indicated in words.

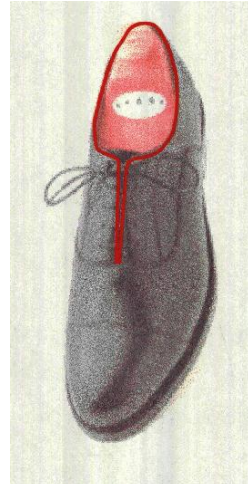
Examples of acceptable position marks (for formalities' purposes)	
<p style="text-align: center;">CTM 4 717 914</p> <p><u>Colour indication:</u> Red</p> <p><u>Description:</u> Red edging, 2 mm in width, running along the edge of the ankle opening and the lace-up section.</p>	

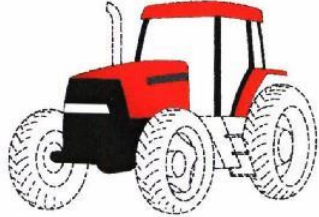
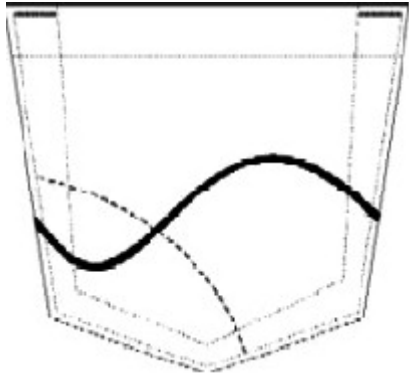
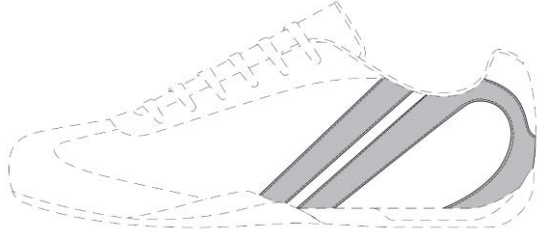
Examples of acceptable position marks (for formalities' purposes)	
<p style="text-align: center;">CTM 9 045 907</p> <p><u>Colours indicated:</u> Red, black and grey</p> <p><u>Description:</u> The mark consists of the combination of the colours red, black and grey as applied to the exterior surfaces of a tractor, namely red as applied to the bonnet, roof and wheel arches, light and dark grey as applied to the bonnet in a horizontal stripe and black as applied to the front bonnet grill, chassis and vertical trim — as depicted in the illustrative representation attached to the application.</p>	
<p style="text-align: center;">CTM 6 900 898</p> <p><u>Description:</u> Two Curves Crossed in One Point Design inserted in a Pocket; the mark consists of a decorative stitching made of Two Curves Crossed in One Point Design inserted in a Pocket; one of the curves is characterized by an arched form, drawn with a fine stroke, while the second one is characterized by a sinusoidal form, drawn with a thick stroke; the unevenly broken lines represent the perimeter of the pocket to which the applicant makes no claim and which serves only to indicate the position of the mark on the pocket.</p>	
<p style="text-align: center;">CTM 8 586 489</p> <p><u>Description:</u> The trade mark is a position mark. The mark consists of two parallel lines positioned on the outside surface of the upper part of a shoe. The first line runs from the middle of the sole edge of a shoe and slopes backwards towards the instep of a shoe. The second line runs parallel with the first line and continues in a curve backwards along the counter of a shoe to the heel of a shoe and ends at the sole edge of a shoe. The dotted line marks the position of the trade mark and does not form part of the mark.</p>	

Position marks are not acceptable if the description shows that the position may vary — e.g. ‘The mark consists of [description of the device] applied to the outside of the goods’. The position of the mark must be clearly defined and evident from the representation and description.

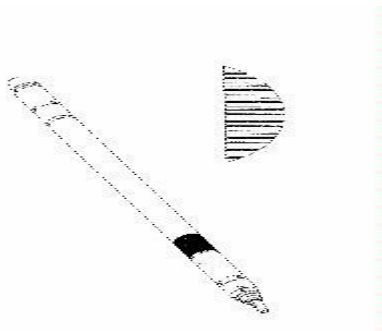
Examples of unacceptable position marks/descriptions (for formalities' purposes)	
<p>CTM 8 682 213</p> <p><u>Description:</u> Trade mark protection is claimed for a stripe positioned on the casing of a soil displacement hammer (so-called displacement mole), the stripe being shown in the isometric overall view of the soil displacement hammer as a black, circular band, which is set off from the other parts of the casing by means of the pattern visible in the additional view, which shows an enlarged (semi-circular) detail of this stripe in a side view of the soil displacement hammer, the pattern being formed by a multitude of circular grooves; the stripe is positioned on a section of the casing, which, viewed from the cone point of the soil displacement hammer, equals the second quarter of the total length of the soil displacement hammer; other forms visible in the representation and/or arrangements are not part of the mark.</p>	<p>Depiction together with description do not clearly define what the sign is and how it is to be placed on the goods:</p>  <p>(It is unclear from the representation from which perspective a semi-circular detail should be visible.)</p>

10.8.3 Tracer marks

Tracer marks are coloured lines or threads applied to certain products. These marks are popular in the textile industry. Other examples are coloured lines on hoses or cables. The mark description should indicate that the mark is a 'tracer mark' and any colours must be indicated in words.

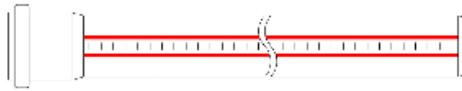
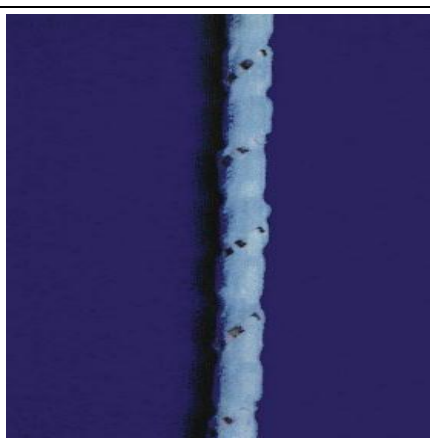
Examples of acceptable tracer marks (for formalities' purposes)	
<p>CTM 7 332 315</p> <p><u>Description:</u> The trade mark consists of a pipe, tube or extruded profile with continuous thin black horizontal lines set at an equal distance apart on the exterior of the pipe, tube or extruded profile, between two parallel red lines running along the length of the pipe, tube or extruded profile.</p>	
<p>CTM 3 001 203</p> <p><u>Colours indicated:</u> Gold on a light background</p> <p><u>Description:</u> Golden band incorporated into a light-coloured functional band, in particular a lead band, for curtains, drapes, table covers and similar goods as an identifying marking.</p>	

10.9 Correction of the mark type

10.9.1 General rules

Where the indication of the mark type in the application is clearly wrong or where there is an obvious contradiction between the mark type selected and the representation, including any mark description, the Office will correct the mark type and inform the applicant, giving a two-month time limit for observations. If there is no response, the correction made by the Office is considered accepted by the applicant. If the applicant disagrees with the amendment, the Office will restore the original indication of type of mark; however, the application may then be rejected as the nature of the mark is not clear.

10.9.2 Examples of recurring mark type deficiencies

10.9.2.1 Word marks

Where the mark type chosen is 'word', but the mark is actually a 'figurative' mark such as in the examples in paragraph 10.2 above (representation in several lines, stylised fonts, etc.), the Office will correct the mark type and update the figurative image in the system. The Office will send a letter to the applicant informing them of the amendment and setting a two-month time limit for observations. If the applicant does not reply within the time limit, the amendment will be deemed to have been accepted. If the applicant files observations objecting to the amendment, and the Office disagrees with the observations, the mark type will be changed back to 'word' mark, but the application will be rejected.

10.9.2.2 Figurative marks

If no mark type has been indicated at all and the mark is clearly figurative corresponding to the examples given above, the type of mark is inserted by the Office and the applicant is informed accordingly.

Sometimes 'figurative' marks in colour are erroneously filed as 'colour marks'. Furthermore, the differences in typology of the miscellaneous marks within the EU Member States may lead to a mark type deficiency, in particular with regard to marks combining a word and a figurative element, which are often incorrectly filed as 'other' rather than as 'figurative' marks. In such cases, the Office will correct the mark type to 'figurative' and inform the applicant, setting a two-month time limit for observations.



Example 1

A **figurative** mark applied for as a **colour per se** mark.

The Office will change the mark type from **colour per se** to **figurative** and send a letter confirming the amendment. If the applicant disagrees, they may submit observations. If the Office disagrees with the observations, it will restore the original indication of the mark type, but the application will then be rejected. If, however, there is no response within the time limit, the change of mark type will be considered as accepted and the application will proceed.

Example 2

The following marks were applied for as mark type 'other':

CTM 9 328 121	
CTM 9 323 346	

When the applicant has chosen as the type of mark 'other', instead of ticking 'figurative', and has added in the explanatory field of the 'other mark' terms like 'text and logo', 'marque sémi-figurative', 'marca mixta', 'Wort-Bild-Marke', or even 'colour per se' (because its mark contains elements in colour), but the mark applied for is clearly a figurative trade mark as defined above, the Office will change the mark type from **other** to **figurative** and send a letter to the applicant informing them of the amendment and giving two months for observations to be filed. If the applicant does not reply within the two-month time limit, the change of mark type will be deemed to have been accepted and the application will proceed. If the applicant files observations objecting to the amendment, and the Office disagrees with the observations, the Office will restore the original indication of the mark type, but the application will then be rejected.

Example 3

In some cases, marks may be filed as, for example, 'figurative', but the representation and/or mark description show that a three-dimensional mark is intended.

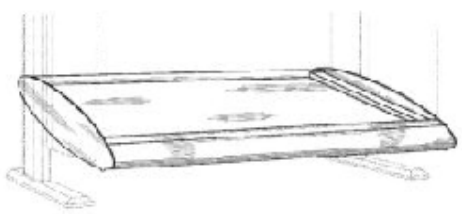
<p>CTM application 10 318 897</p> <p><u>Mark type chosen:</u> Figurative</p> <p><u>Description:</u> The mark consists of a shape for a shelf for the goods. The ends of the shelf have an elliptical shape. The front edge of the shelf has a tapered shape. The portion of the mark shown in dotted lines is not part of the mark and serves only to show positioning or placement of the mark.</p>	
--	--

In this case the mark description, which refers to 'a shape for a shelf', is contradictory to the mark type 'figurative'. Therefore, the applicant was requested to amend the mark type to 'three-dimensional' or to delete the mark description.

11 Series Marks

Unlike some national systems, the CTMR does not allow for series marks. When different versions of a trade mark are required, a separate CTM application is required for each of those versions.

Example 1

A **word** mark filed as 'BRIGITTE brigitte Brigitte' will **not** be 'interpreted' as 'the word 'Brigitte', written either in upper case letters or in lower case letters or in 'normal' script'; it will be seen as the word mark containing the female name 'Brigitte' three times. No deficiency letter will be sent and no changes to the mark will be accepted.

Example 2

A **word** mark filed as 'Linea Directa/Direct Line/Ligne Directe' will **not** be 'interpreted' as 'the term 'direct line', either in Spanish or in English or in French'; it will be seen as a word mark containing all three language versions in the same sequence as applied for. No deficiency letter will be sent and no changes to the mark will be accepted.

11.1 Multiple figurative representations

In an application submitted through e-filing, the reproduction of the mark must be uploaded as a single JPEG file. When the paper application form is used, the mark reproduction must be attached on a single A4 sheet.

The A4 sheet or JPEG file must contain only one representation of the mark as applied for and no additional information whatsoever (except the indication of the correct position of the mark where this is not obvious, see Rule 3(2) CTMIR).

When a paper-filed application contains more than one A4 sheet showing different marks, albeit very similar ones, the Office issues a deficiency letter requesting the applicant to choose one mark from among the different variations. If the applicant wants to protect the others as well, it will have to file a new application for each of the other marks it wishes to register. When there is no response to the deficiency letter within the time limit set therein, the application will be rejected.

Where an application, filed electronically or on paper, contains a JPEG file or an A4 sheet showing what might be seen as more than one mark representation, the combination as a whole of all those variations, as they appear on that one page, will be deemed as the mark for which protection is sought. Changes to the mark representation are not allowed.



Since the JPEG file attached to the above application contained all of the above images on a single page, the entirety of variations of logos and colours and texts is deemed one single trade mark.

12 Indication of Colour

Rule 3(5) and Rule 80 CTMIR

Word marks and sound marks cannot be in colour, since it is the word(s) and the sound(s) that are protected even if a sonograph is represented in colour.

Figurative, three-dimensional, holograms and other marks can be applied for in colour or without colour.

Colour per se marks are a specific type of trade mark and are explained in paragraph 10.5 above.

When a mark is to be registered in colour, a coloured mark representation must be filed with the application and the colours used indicated in words. An international colour code such as a Pantone number can be added to the colour indication, although it cannot replace the indication in words (green, blue, red).

Black, grey and white may be claimed as 'colours'. The indication of the colours made by the applicant ('black and white' or 'black, grey and white', etc.) is subject to the same rules as any other colour indication.

Where a coloured representation is supplied, the Office considers that the applicant implicitly claims colour and the application is therefore considered to be for registration of a mark in colour. After filing in colour, it is not possible to change the application to a black and white mark (decision of 25/08/2010, R 1270/2010-4, Form von Prüfköpfen (3D)). The only option for the applicant is to file a new application with a black and white representation.

If, in an application for a mark in colour, the colours grey, black and white are used other than for contrasting or delimiting, these must also be claimed.

Expressions like ‘multicolour’, ‘of various colours’, ‘in any possible combination’ or ‘in any proportion’ are not acceptable (decision of 25/08/2010, R 1270/2010-4, Form von Prüfköpfen (3D)).

Where the indication of colour(s) has been omitted, the Office will propose the colour(s) to the applicant, setting a time limit for reply. If no reply is received before expiry of the time limit, the insertion of the colour(s) indicated by the Office will be deemed to have been accepted. If the applicant disagrees with the insertion of the colours, the Office will delete the indication. However, in such cases if the applicant fails to indicate the colours accurately, the application will be rejected.

If it is not possible to establish the colour(s), the Office will request that the applicant provides the colours. If the applicant fails to submit an accurate colour indication within the time limit, the application will be rejected (Rules 9(4) and 3(5) CTMIR).





If the application contains a colour claim but no mark representation in colour has been received, there is a formal discrepancy between the trade mark applied for and the colour(s) claimed. Any colour indication will be corrected by the Office (i.e. to black, white and/or grey) and the applicant will be informed.

The **only exception to this rule** is when the application is filed by fax, in which case the applicant must (on its own motion) send a representation in colour by post within one month of sending the application. This one-month time limit cannot be extended. When the representation in colour is received within this time limit, the original representation in black and white will be substituted by the new representation in colour. If the applicant does not send the representation of the mark in colour, the Office will not request it. If a colour representation is not submitted within the one-month time limit, any colour indication will be corrected to black, white and/or grey as appropriate and the applicant will be informed.

When the mark representation is filed by other means than fax and in black and white — including grey — it cannot be altered into a mark in colour even if the black and white mark was filed along with a colour claim, a colour indication and /or a description referring to colours.

It is to be noted that indications like ‘transparent’ or ‘without colour’, ‘colourless’ are not indications of colours and will not be accepted. When a mark representation shows, for example, a ‘colourless’ object made of glass or a similar material before a coloured background, the mark description is the appropriate place to explain that the object in question is colourless and shown in front of a coloured background that is not part of the mark.

Examples of colour indications (for formalities' purposes)	
CTM 10 275 519	
<p><u>No colour indication</u></p> <p>No colour indication required. However, black and white may be claimed by the applicant if these colours are to be considered a feature of the mark.</p>	

Examples of colour indications (for formalities' purposes)	
<p>CTM 8 401 572</p> <p><u>Colour indication:</u> Cream, blue, orange, brown, red, pink, yellow, black, green, maroon</p> <p>Black must be indicated as the application is for a mark in colour and black is not only used for contrasting and delimiting, but also for the tail, eye, nose and ears.</p>	
<p>CTM 10 456 762</p> <p><u>No colour indication</u></p> <p>No colour indication required. However, black, white and grey may be claimed if these colours are to be considered a feature of the mark.</p>	
<p>CTM 9 732 793</p> <p><u>Colour indication:</u> Red, orange, yellow, mint green, sea green, blue, purple, pink</p> <p>Black should be claimed in this application as this is a mark in colour and black is used other than for contrasting and delimiting, i.e. for the letters.</p>	
<p>CTM 10 336 493</p> <p><u>Colour indication:</u> Purple, blue, yellow, white, orange, red and black.</p> <p>Black is claimed, however, the Office would accept the colour indication without black as it is used only for delimiting — around the words 'POP-UP!'</p>	

In cases where the colour indication includes information that is not relevant to this field but is relevant to another field of the application, the Office will move the text to the relevant field. Examples of this are where the colour indication includes a mark description, disclaimer or list of goods and services.

13 Mark Descriptions

Rule 3(3) CTMIR

A mark description is mandatory for CTM applications for mark type 'other'. This is because an explanation of what is meant by 'other' is required to clarify the scope of protection (define the nature of what is to be protected). If the description is missing or unclear, a deficiency will be raised. If it is not remedied, the mark will be rejected.

Likewise, where colour per se combinations are applied for, the specification of the ratio of the colours must be provided.

Word marks cannot have a mark description; if a description is included, it will be removed by the Office and the applicant will be informed.

For the remaining mark types, a mark description is not mandatory, but it may be useful in assisting the Office to determine the nature of the mark or clarify the representation. If the description does not match the representation of the mark, the applicant will be asked to delete or amend it. The representation cannot be changed to match the mark description.

Where the CTM application is intended to be used as the basis for an international application, the applicant should consider including a mark description in its CTM application, since a description is a formality requirement in some countries. For more information on international applications, see the Guidelines, Part M, International Marks.

A mark description can only define what can be seen in the mark representation or heard in a sound mark. It must not contain an interpretation of what is meant by a certain combination of letters or graphic elements or what the designer had in mind or an indication that the mark will only be used in certain Member States, etc. Nor is it possible to state in a mark description that the mark can contain, for example, the colours blue and green or red and yellow; the description should state either blue/green or red/yellow — namely what can be seen in the coloured mark representation.

The representation of the mark together with a description, if any, must be sufficient for the Office to see and understand what is being sought to be registered.

A mark that consists of or includes letters from a non-EU alphabet, for which the applicant provides a transliteration or translation together with a transliteration of the term in the mark description, is acceptable.

Where the mark description does not match the representation of the mark, the Office will raise a deficiency, which the applicant will have two months to remedy. If the deficiency is not remedied:

1. the Office will reject the CTM application (for ‘colour **per se** combinations’ and ‘other’ marks that require a mark description to explain the scope of protection);
2. the Office will delete the description (in all other cases, as the description is not mandatory).

When a mark description is deleted, the applicant will be informed. In no case can the mark representation be changed to match the mark description.

Where the mark description includes information that is not a relevant description and the information is not relevant to any other field on the application form (e.g. the text interprets the meaning/symbolism of the mark or indicates in which Member States the mark will be used), the Office will delete the mark description and inform the applicant.

Where the mark description includes information that is not a relevant description and the information is relevant to another field, the Office will move the text to the relevant field.



Examples of this are where colours are mentioned in the mark description field, are valid as a colour indication and will be keyed-in in the relevant field for the indication of colours. Where goods and services are mentioned in the mark description field rather than in the field for goods and services, the Office will delete them from the mark

description and, if the goods and services are not already covered in the specification, the Office will inform the applicant that it may add the goods and services.

This principle applies *mutatis mutandis* in all cases where necessary information on the mark is included in the wrong field of the application.

A mark description can be amended or added after the filing of the mark in order to more clearly describe the content of the mark, for example, the movement depicted. However, such an amendment must not alter the nature of the mark substantially. An amendment of the description is not possible after registration.

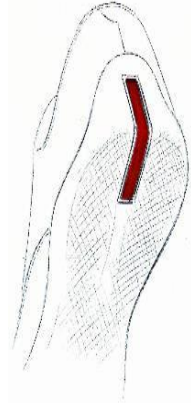
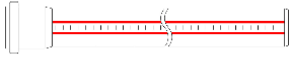
Examples of accepted mark descriptions (for formalities' purposes)	
<p>CTM 1 915 248</p> <p><u>Mark type:</u> Figurative</p> <p><u>Description:</u> Trade mark consisting of the word 'ALBALUNA' written in special lettering, in which the letter 'L' is superimposed on the outline of a quarter moon.</p>	
<p>CTM 2 023 950</p> <p><u>Mark type:</u> Figurative</p> <p><u>Description:</u> The trade mark consists of the word 'AIA' in red, stylised upper case lettering, with the letter 'I' surmounted by a red circle, inserted in a white oval delimited by a green rectangular frame, the whole outlined by a gold border.</p>	
<p>CTM 8 837 502</p> <p><u>Mark type:</u> Other (Position)</p> <p><u>Description:</u> The position mark consists of a logo comprising a rectangle with rounded corners with an encircling light-coloured border and the two light-coloured letters PP arranged next to one another on a dark background. The logo is displayed on a screen during the broadcasting of a television programme or other programme in the upper right-hand corner of the screen.</p>	
<p>CTM 6 453 104</p> <p><u>Mark type:</u> Three-dimensional</p> <p><u>Description:</u> Three-dimensional trade mark consisting of a bottle shape that is wider in the centre than at the base. This bottle has a distinctive spiral decoration made up of a golden dotted line, interrupted by golden butterflies; at the end of the line, at the front, there are two butterfly figures, one large and one small, in red with a black and gold double outline. Below these two figures is the word 'BELLAGIO' in upper case white letters with a red outline; below this are the words 'The Beautiful Life' in gold. The bottle is closed with a burgundy red cap on which there are several aligned golden butterflies.</p>	

Examples of accepted mark descriptions (for formalities' purposes)	
<p style="text-align: center;">CTM 1 027 747</p> <p><u>Mark type:</u> Other (position)</p> <p><u>Description:</u> Red stripe placed longitudinally along an item of footwear partly covering the rear area of the sole and partly the rear area of the item of footwear. Any moulding seen on the sole or on the rear part of the item of footwear and/or production characteristics are not part of the trade mark.</p>	
<p style="text-align: center;">CTM 7 332 315</p> <p><u>Mark type:</u> Other (tracer mark)</p> <p><u>Description:</u> The trade mark consists of a pipe, tube or extruded profile with continuous thin black horizontal lines set at an equal distance apart on the exterior of the pipe, tube or extruded profile, between two parallel red lines running along the length of the pipe, tube or extruded profile.</p>	
<p style="text-align: center;">CTM 2 818 334</p> <p><u>Mark type:</u> Other (movement)</p> <p><u>Description:</u> Two hands form a 'T', in which, from the position of the viewer, the right hand, stretched out flat with fingertips pointing upwards (so that only the narrow edge of the hand is visible) moves from the upper left of the image to the centre, while the left hand, also stretched out flat with fingertips pointing upwards and viewed from the side, moves from the upper right of the image to the centre; both hands then meet in the centre of the image with the upwards-pointing fingertips of the right hand touching the surface of the left hand roughly in the centre; the viewer therefore sees a side view of the descending left hand coming to rest on the fingertips of the ascending right hand; as a result of this movement, the viewer is able at this point to recognise the letter 'T'.</p>	

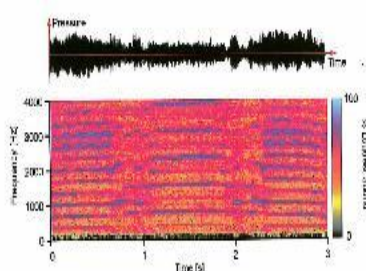
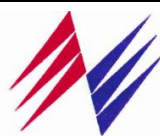
Examples of accepted mark descriptions (for formalities' purposes)	
<p style="text-align: center;">CTM 5 090 055</p> <p><u>Mark type:</u> Sound</p> <p><u>Description:</u> The mark consists of the yell of the fictional character TARZAN, the yell consisting of five distinct phases, namely sustain, followed by ululation, followed by sustain, but at a higher frequency, followed by ululation, followed by sustain at the starting frequency, and being represented by the representations set out below, the upper representation being a plot, over the time of the yell, of the normalised envelope of the air pressure waveform and the lower representation being a normalised spectrogram of the yell consisting of a three-dimensional depiction of the frequency content (colours as shown) versus the frequency (vertical axis) over the time of the yell (horizontal axis), the mark also being reproduced in the attached electronic file containing the sound.</p>	
<p><u>Mark type:</u> Figurative</p> <p><u>Description:</u> The mark consists of three blue shapes and three red shapes, facing in opposite directions.</p>	

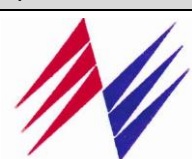
Example of a mark description that would not be accepted (for formalities' purposes)	
<p><u>Mark type:</u> Figurative</p> <p>Mark Description: The mark consists of two hands grasping the air.</p>	

14 Disclaimer

Article 37 CTMR
Rule 1(3) CTMIR

A disclaimer is a statement by the applicant that they disclaim any exclusive right to an element of the trade mark representation that is not distinctive.

An applicant cannot disclaim use of its trade mark on a particular good or service in its specification. If the applicant wishes to reduce the scope of the goods and services that the CTM application has protection for, it will need to request a restriction to the list of the goods and services.

Typically, elements that designate the kind, quality, quantity, value or geographical origin of goods or services need not be disclaimed. Similarly, ordinary words that would be common to many marks ('the', 'of', etc.) or other non-distinctive matter (borders, commonplace shapes of containers, etc.) do not need to be disclaimed. Where a trade mark consists of a combination of elements, each of which in itself is clearly not distinctive, there is no need for a disclaimer of the separate elements. For example, if a

periodical had as its trade mark 'Alicante Local and International News', the individual elements within it would not need to be disclaimed.

This is not a mandatory field on the application form. The Office only inserts the element of the trade mark representation requested as a disclaimer; no additional text such as 'the applicant does not claim any exclusive right to element x' is to be added in this field.

Example of an acceptable disclaimer (for formalities' purposes)		
Mark	Goods	Disclaimer
DOODAH SOCKS	Class 25	'socks'

Examples of unacceptable disclaimers (for formalities' purposes)		
Mark	Goods and services	Disclaimer
DOODAH SOCKS	Classes 1 to 45	The mark will not be used in Germany
Mark	Goods	Disclaimer
DOODAH SOCKS	Socks in Class 25.	The applicant disclaims any use of the mark for men's socks
This is not a disclaimer, but a limitation of the goods, and the text will be deleted.		
Mark	Goods in Class 30: Ice cream; ice-cream products; ice cream drinks; ice-cream cakes; ice cream mixes; instant ice cream mixes; ice; binding agents for ice.	Disclaimer
Gelamondo		Softeis (Soft ice-cream)
This is not a disclaimer and the text will be deleted.		

Disclaimers may be added to the trade mark application at a later stage, if appropriate (e.g. if the application is being opposed and the parties agree on a disclaimer to reach a friendly settlement).

More on disclaimers can be found in the Guidelines, Part C, Opposition, Section 2, Identity and Likelihood of Confusion, Chapter 4, Distinctiveness .

If the disclaimer is objectionable on formality grounds, a deficiency letter will be sent to the applicant to remedy the deficiency. If the deficiency is not remedied, the disclaimer will be deleted.

15 (Convention) Priority

Articles 29 and 31 CTMR
 Rules 6 and 9 CTMIR
 Decision EX-03-5 and Decision EX-05-05 of the President of the Office

The effect of the right of priority is that the date of priority will count as the date of filing of the Community trade mark application for the purposes of establishing which rights take precedence.

The principles of priority were first laid down in the Paris Convention for the Protection of Industrial Property of March 20, 1883, which has been revised several times and was last amended in 1979 and ratified by many Contracting States. Article 4 of this Convention — with regard to trade marks — corresponds to Article 29 CTMR.

The ‘convention priority’ right is a right limited in time, which is triggered by the first regular filing of a trade mark. A regular national filing is any filing that is adequate to establish the date on which the application was filed in the country concerned, whatever may be the subsequent fate of the application. (Article 4(3) of the Paris Convention). It may be claimed during the six months following the first filing, provided the country of first filing was a party to the Paris Convention or to the WTO, or a country with a reciprocity agreement (cf. Rule 101 CTMIR — reciprocity findings by the Commission).

The States and other entities mentioned below, inter alia, are not members of any of the relevant conventions nor do they benefit from reciprocity findings. Therefore, priority claims based on filings in these countries will be **rejected**.

Independent States (not member of PC, WTO or reciprocity agreement):

- Afghanistan (AF)
- Aruba (AW)
- Cook Islands (CK)
- Eritrea (ER)
- Ethiopia (ET)
- Kiribati (KI)
- Marshall Islands (MH)
- Micronesia (Federated States of) (FM)
- Nauru (NR)
- Palau (PW)
- Somalia (SO)
- Tuvalu (TV).

Other entities (not member of PC, WTO or reciprocity agreement):

- Abkhazia (GE-AB)
- American Samoa (AS)
- Anguilla (AI)
- Bermuda (BM)
- Cayman Islands (KY)
- Falkland Islands (FK)
- Guernsey (Channel Island) (GC)
- Isle of Man (IM)
- Jersey (Channel Island) (JE)
- Montserrat (MS)
- Pitcairn Island (PN)
- Saint Helena (SH)
- Somalia (SO)
- Turks and Caicos Islands (TC)
- (British) Virgin Islands (VG).

A priority claim of a previous CTM is acceptable if that CTM was granted a filing date. A priority claim of an international registration is not acceptable. This is because the principle of first filing applies (Article 29(4) CTMR — see paragraph 15.1 below) and the priority claim can only be based on the relevant basic mark.

The applicant may claim the priority of one or more previous trade mark applications, namely a national (or Benelux) application filed in or for a State party to the Paris Convention, a Member of WTO, a State for which the Commission has confirmed reciprocity, or a CTM application. See paragraph 15.1, 'Principle of first filing' for information on applications that claim the priority of more than one earlier application.

Any filing that is equivalent to a regular national filing under the domestic law applicable to it will be recognised as giving rise to the right of priority.

Priority claims may be filed either in the CTM application or subsequent to the filing of the application, in which case the applicant must submit the declaration of priority, indicating the date on which and the country in which the previous application was made, within a time limit of two months from the filing date.

The claim may be implicit so that the submission of the priority documents (within the time limit of two months) will be construed as a declaration of priority. Simple filing receipts containing the **country** and **date** of the earlier application(s) are accepted.

Within three months of the receipt of the declaration of priority at the Office, the applicant must provide the Office with the **file number(s)** of the previous application(s).

If the mark concerned is in colour, the submission of colour photocopies concerning the earlier application(s) is mandatory.

Priority will be granted if the following requirements are met:

1. the previous application(s) is a first regular filing ('first filing');
2. the mark in the earlier application(s) and the CTM applied for are the same;
3. the goods and services are identical or are contained within those of the earlier application(s) (it is sufficient that one good or service is the same);
4. the proprietor is the same;
5. the filing date of the CTM is within six months of the filing date of the earlier application;
6. the priority must be claimed with the application or within two months from the filing date.

It is possible to claim both priority and seniority based on the same prior application/registration if the first filing was registered in due time.

15.1 Principle of first filing

The previous application must be a first regular filing and cannot bear the same date as the CTM application. The Office will therefore check (i) that there was no priority claim made on the prior application(s) and (ii) that no seniority claim made for the CTM application relates to a mark that has a filing date prior to that of the application(s) from which priority is claimed. The Office will also check that the CTM application is filed no later than six months from the date of filing of the earlier application(s).

Where priority of more than one earlier application is claimed, the goods and/or services covered by each of those applications must be different in order for the principle of first filing to be met. For examples, please see paragraph 15.8.1 below.

15.2 Triple identity

The Office will check that the CTM application and the priority documents contain the same mark, refer to the same applicant and have at least one product or service in common.

15.2.1 Identity of the marks

The Office and a number of trade mark offices of the European Union have agreed on a common practice under the European Trade Mark and Design Network concerning the identity of trade marks filed in black and white and/or greyscale as compared to those filed in colour. The offices believe that the Common Practice Note is a reflection of the current case-law that a trade mark filed in black and white and/or greyscale is, for the purposes of assessing priority, not identical to the same mark filed in colour unless the differences in colour or in the shades of the grey are so insignificant that they could go unnoticed by the average consumer (judgments of 19/01/2012, T-103/11, Justing, EU:T:2012:19, § 24, 20/02/2013, T-378/11, Medinet, EU:T:2013:83 and 09/04/2014, T-623/11, Milanówek cream fudge, EU:T:2014:199). An insignificant difference between two marks is one that a reasonably observant consumer will perceive only upon examining the marks side by side.

The principle described above applies to all cases where marks are compared for the purpose of priority claims. In relation to word marks, the mark applied for will in most cases be deemed to be the same as the earlier mark where there is a difference only in respect of typeface or where one mark is in upper case letters and the other in lower case. Furthermore, a difference in punctuation or the addition of a space separating two words will not usually prevent the marks from having identity (decisions of 09/10/2012, R 0797/2012-2, Water Jel and 15/07/1998, R 0010/1998-2, THINKPAD).

The Office will also check the mark type of the earlier application, because a different mark type may mean that the CTM application is different from the earlier mark. For example, a figurative mark is not the same as a three-dimensional mark or a position mark. However, a word mark can be considered to be the same as a figurative mark if standard type is used in the figurative mark (see the examples in paragraph 15.8.2 below).

In assessing the marks, the Office will also consider any colour indication in the earlier application.

15.2.2 Identity of the goods and services

The Office will check that there is at least one corresponding product or service in the lists covered by the first filing and the CTM application. The examination will not extend to all the goods and services covered under the lists, nor will it be limited to class numbers only.

15.2.3 Identity of the owner

Priority can be claimed by the applicant of the first application or its successor in title. In the latter case, the transfer must have taken place prior to the filing date of the CTM application and documentation to this effect must be provided. The right of priority as such may be transferred independently of whether or not the first application as a whole is transferred. Priority can therefore be accepted even if the owners of the CTM application and the earlier right are different, provided evidence of the assignment of the priority right is supplied; in this case, the execution date of the assignment must be prior to the filing date of the CTM application.

Subsidiary or associated companies of the applicant are not considered the same as the CTM applicant.

Where the applicant of the first application states that it has changed its name since the first filing and files the CTM application under its new name, the applicant is considered to be the same person.

For the distinction between a change of name and a transfer, see the Guidelines, Part E, Register Operations, Section 3, CTMs as Objects of Property, Chapter 1, Transfer.

15.3 Priority requirements not satisfied

If the priority claim does not satisfy any of the above requirements, the applicant will be invited to remedy the deficiency or make observations within the time limit set by the Office.

If there is no response, or if the deficiencies are not remedied within the time limit set, the Office will notify the loss of rights to the applicant and set a two-month time limit during which the applicant may request a formal, appealable decision on the loss of rights.

If the applicant formally requests a decision within the time limit, the Office will issue a formal decision on the loss of rights.

15.4 Priority documents not provided

If the priority documents are not submitted with the application, the Office will check to determine if the relevant information can be found online. If the information to grant the priority claim cannot be found online, the Office will send a letter to the applicant requesting it. The applicant will be given a time limit of two months to remedy the deficiency; as a rule, this time limit will not be extended. Usually, the deficiency letter will be issued before expiry of the original time limit to submit the priority documents (three months from date of receipt of the priority claim). In this case, the two-month deficiency time limit will be calculated from the date of expiry of the original time limit for submission of the priority documents. In accordance with Decision EX-03-5, certified copies are not necessary. Simple filing receipts that do not contain all the necessary information for examining the priority claim (e.g. they only contain class numbers for the goods and services of the prior application and not the full text version indicating all the goods and services) are not acceptable.

15.5 Language of previous application

If the language of the previous application is not one of the official EU languages, the Office will invite the applicant to file a translation within three months. The time limit for filing the translation may be extended at the request of the applicant. An extension in this case may be for up to two months.

15.6 Priority date check after changing of the filing date

If the CTM application has a filing date change, the Office must check that the new filing date is still within six months of the priority claim.

15.7 Examples of priority claims

15.7.1 First filing

In the example below, the priority claim of more than one earlier application is acceptable because the goods covered by each of those earlier applications are different and therefore the principle of first filing is met.

First filing	Country	Goods/services	CTM filed	Goods/services
6 April	Italy	Perfumes	11 September	Perfumes, Bags, Clothing
9 May	Germany	Bags		
23 May	Spain	Clothing		

In the example below, the two earlier trade mark applications were filed for exactly the same goods. The priority claim based on the Greek application has to be rejected since the trade mark was applied for in Spain first; thus the Greek application is no longer a first filing.







First filing	Country	Goods/services	CTM filed	Goods/services
6 April	Spain	Cheese, wine		Cheese, wine
7 April	Greece	Cheese, wine	4 October	Cheese, wine



In the example below, priority cannot be claimed from a first filing in Somalia, since Somalia is not a Member State of the Paris Convention or the World Trade Organisation and has no reciprocity agreement confirmed by the EU Commission. Therefore, the first filing in Italy is the one considered for the priority claim; the other filing cannot be taken into consideration.



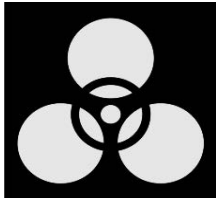

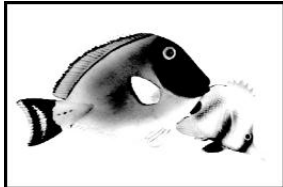
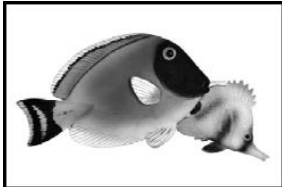

First filing	Country	Goods/services	CTM filed	Goods/services
5 April	Somalia	Cars, T-shirts		Cars, T-shirts
7 July	Italy	Cars, T-shirts	2 October	Cars, T-shirts









--	--	--	--	--

15.7.2 Comparison of the marks

Examples of acceptable priority claims (for formalities' purposes)	
CTM application (word mark) EVAL	Priority claim (word mark) EVAL
CTM application (word mark) Luna	Priority claim (word mark) <i>Luna</i>
CTM application (figurative mark) 	Priority claim (figurative mark) 
CTM application (figurative mark) 	Priority claim (figurative mark) 
CTM application (figurative mark) 	Priority claim (figurative mark) 
CTM application (figurative mark) 	Priority claim (figurative mark) 

Examples of acceptable priority claims (for formalities' purposes)	
<p>CTM application (figurative mark)</p> 	<p>Priority claim (figurative mark)</p> 

Examples of unacceptable priority claims (for formalities' purposes)	
<p>CTM application (colour per se)</p> 	<p>Priority claim (colour per se)</p> 
<p>CTM application (word mark)</p> <p>Chocolate Dream</p>	<p>Priority claim (word mark)</p> <p>Chocalate Dream</p>
<p>CTM application (figurative mark)</p> 	<p>Priority claim (figurative mark)</p> 
<p>CTM application (figurative mark)</p> 	<p>Priority claim (figurative mark)</p> 

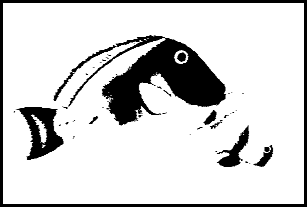
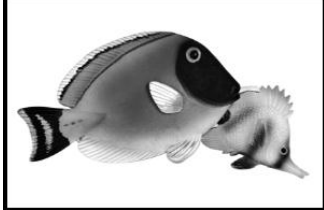





Examples of unacceptable priority claims (for formalities' purposes)	
<p>CTM application (figurative mark)</p> 	<p>Priority claim (figurative mark)</p> 
<p>CTM application (figurative mark)</p> 	<p>Priority claim (figurative mark)</p> 
<p>CTM application (figurative mark)</p> 	<p>Priority claim (figurative mark)</p> 
<p>CTM application (figurative mark)</p> 	<p>Priority claim (figurative mark)</p> 
<p>CTM application (figurative mark)</p> 	<p>Priority claim (figurative mark)</p> 

Further examples with regard to word marks (for formalities' purposes)			
First trade mark	CTM application	the same	not the same
Word mark Percy & Reed	Word mark Percy + Reed		X
Word mark Percy & Reed	Word mark Percy and Reed		X
Word mark Percy & Reed	Word mark Percy & Reed	X	
Word mark Percy & Reed	Word mark Percy & REED	X	
Word mark Percy & Reed	Word mark PERCY & REED	X	
Word mark Percy & Reed	Word mark <i>Percy & Reed</i>	X	
Word mark POPEYE	Word mark POPeYe	X	
Word mark POPEYE	Word mark PopEye	X	
Word mark POPEYE	Word mark POP-EYE	X	
Word mark: POPEYE	Word mark: POP EYE	X	
Word mark POPEYE®	Word mark POPEYE	X*	
Word mark POPEYE	Word mark POPEYE!?		X
Word mark POPEYE	Word mark POPEYE·	X	

* The symbols ™ and ® are not considered parts of the mark.

Examples regarding identity between figurative signs as compared to word marks (for formalities' purposes)			
First trade mark	CTM application	the same	not the same
Word mark Percy & Reed	Figurative mark Percy & Reed (figurative mark in standard type face)	X	

Examples regarding identity between figurative signs as compared to word marks (for formalities' purposes)			
First trade mark	CTM application	the same	not the same
Word mark Percy & Reed	Figurative mark Percy & Reed (words distributed over several lines)		X
Word mark Percy & Reed	Figurative mark Percy & Reed (colour claim)		X

Further examples with regard to figurative marks (for formalities' purposes)			
First trade mark	CTM application	the same	not the same
			X
			X
		X*	

* The symbols TM and ® are not considered parts of the mark.

15.7.3 Comparison of the goods and services

The first example below is the most usual situation: The prior application corresponds fully to the CTM application.

First filing	Country	G&S	CTM filed	G&S CTM
5 April	UK	Hats, shoes	1 October	Hats, shoes

In the next example, both priority claims can be accepted since application number XY 1234 is the first filing with respect to 'cars' and application number XY 1235 is the first filing with regard to 'airplanes'.

First filing	Country	JP application No	G&S	CTM filed	G&S CTM
5 April	Japan	XY 1234	Cars		

First filing	Country	JP application No	G&S	CTM filed	G&S CTM
5 April	Japan	XY 1235	Airplanes	2 October	Cars, airplanes

In the next example, the priority claim concerns 'hats' and 'shoes', which are common to the first filing and the CTM application. No priority will apply with respect to 'bags'.



First filing	Country	G&S	CTM filed	G&S CTM
5 April	USA	Cars, hats, shoes	1 October	Hats, shoes, bags

In the last example, priority is claimed for first filings in France, Canada and China. The CTM application has been filed within six months of each of the first filings and the priority claims will be accepted although, the Canadian application does not constitute a first filing for 'hats' ('hats' appear in the French application, which had been filed before). Comparing the dates and the lists of goods and services of the three priorities, the priority claims will be accepted.

First filing	Country	G&S	CTM filed	G&S CTM
5 April	France	Hats, shoes		
6 April	Canada	Cars, hats, beer	5 October	
7 April	China	Wine, telecommunication services		Hats, shoes, cars, beer, wine, telecommunication services

15.7.4 Priority claims based on series marks

A series of trade marks means a number of trade marks that resemble each other in material details and differ only in terms of non-distinctive character. Whereas the CTMR does not allow for the filing of series marks, some national offices (e.g. the United Kingdom, Australia, etc.) do, and such a series of marks filed in one single application can contain numerous very similar marks. When the first filing consists of a series mark, two or more slightly different mark representations will be seen. The priority claim is acceptable with regard to the one reproduction that is identical to that showing the mark applied for as a CTM.

Examples of priority claims based on series marks		
First filing	CTM	Priority claim acceptable
Series of marks 		Yes
Series of marks Café@Home CAFÉ@HOME Café@Home CAFÉ@HOME	CAFÉ@HOME	Yes

15.7.5 Claiming priority for three-dimensional or 'other' marks

Some national IP offices do not allow the filing of more than four representations in the case of three-dimensional or other marks.

If a CTM application claims priority of such a first filing, and six (or more, in the case of 'other' marks) depictions/perspectives of the mark are filed with the CTM application, the marks in question will still be considered identical if the presentations of the first filing coincide with a part of what was sent for the CTM application and if the object is undoubtedly the same.

15.7.6 Priority claims involving collective marks

Priority can be claimed from a collective mark when applying for an individual Community trade mark and vice versa.

16 Exhibition Priority

Article 33 CTMR; Rule 7 CTMIR

Exhibition priority entails claiming as priority date of the CTM application the date on which the goods or services covered by the CTM application were displayed at an officially recognised exhibition under the mark as filed. The applicant can claim exhibition priority within six months of the first display. Evidence of the display must be filed.

Like 'convention priority', exhibition priority can be claimed either in the application or subsequently to the filing of the CTM application. Where the applicant wishes to claim an exhibition priority subsequent to the filing of the application, the declaration of priority indicating the name of the exhibition and the date of first display of the goods or services must be submitted within a time limit of two months of the filing date.

Within three months of the receipt of the declaration of priority the applicant must provide the Office with a certificate issued at the exhibition by the responsible authority. This certificate must state that the mark was in fact used for the goods or services, the opening date of the exhibition and, where the first public use did not coincide with the opening date of the exhibition, the date of the first public use. The certificate must be accompanied by an identification of the actual use of the mark, duly certified by the authority.

Priority can only be granted where the application for a CTM is filed within six months of first display at an exhibition recognised for this purpose, namely a world exhibition within the meaning of the Convention of 22 November 1928. These exhibitions are very rare and Article 33 CTMR does not protect the display at other, national, exhibitions. The exhibitions can be found on the website of the Paris Bureau International des Expositions: <http://www.bie-paris.org/site/en/>.

As to the triple identity of the trade mark, applicant and list of goods and services, the same criteria apply as for 'convention priorities' mentioned in paragraph 15 above.

The claim may be implicit. Where there is no indication of the claim in the application, the submission of the exhibition priority documents (within the time limit of two months) will be construed as a declaration of priority.

17 Seniority

Article 34 CTMR
Rules 8, 28 and Rule 96(2) CTMIR
Communication 2/00, Decision EX-03-5 and Decision EX-05-5 of the President of the Office

The proprietor of an earlier trade mark registered in a Member State, including a trade mark registered in the Benelux countries, or registered under international arrangements having effect in a Member State, who applies for an identical trade mark for registration as a CTM for goods or services that are identical to or contained within those for which the earlier trade mark has been registered, may claim for the CTM application the seniority of the earlier trade mark in respect of the Member State in or for which it is registered.

Seniority has the sole effect that, where the proprietor of a CTM surrenders the earlier trade mark for which seniority has been claimed or allows it to lapse, the proprietor will be deemed to continue to have the same rights as he or she would have had if the earlier trade mark had continued to be registered.

This means that the CTM application represents a consolidation of earlier national registrations. If an applicant claims seniority for one or more earlier registered national marks and the seniority claim is accepted, the applicant may decide not to renew the earlier national registrations but still be in the same position as if the earlier trade mark had continued to be registered in those Member States where the earlier marks were registered.

Seniority under Article 34 CTMR must be claimed with the application or within two months from the filing date of the CTM application. The documents in support of the claim must be submitted within three months of the claim. The seniority claim may be implicit. If the applicant sends only the documents concerning the earlier registrations within two months from the filing date of the CTM application, the Office will construe this as a seniority claim concerning these earlier registrations.

Seniority may be claimed not only for earlier national registrations, but also for an international registration with effect in an EU country. No seniority claim is possible, however, for an earlier CTM registration or local registrations, even if the territory is part of the European Union (e.g. Gibraltar).

17.1 Harmonised seniority information

In order to be able to properly manage seniorities, all seniority entries in the system need to have the same format as that used in the databases of the national offices.

To enhance harmonisation between the Office and participating IP offices, a list with the required format for seniorities has been established (see Annex 1). This list

provides a description of the format/formats used in each of the national offices, insofar as this has been determined.

Therefore, when checking seniority, the Office must verify if the format of the seniority corresponds to the format used at the national level.

17.2 Seniority examination

A valid claim must contain the indications of:

1. the Member State or Member States of the EU in or for which the earlier mark for which seniority has been claimed is registered;
2. the filing date of the relevant registration;
3. the number of the relevant registration;
4. the goods or services for which the mark is registered.

Pursuant to Decision EX-05-5 of 01/06/2005, the proprietor is not required to file a copy of the registration if the required information is available online. If the copy of the registration is not submitted, the Office will first search for the necessary information on the respective website and only if the information is not available there will ask the proprietor for a copy by means of a deficiency letter. Pursuant to Article 3 of Decision EX-03-5, the copy of the relevant registration must consist of a copy (simple photocopies suffice) of the registration and/or renewal certificate or extract from the Register, or an extract from the relevant national gazette, or an extract or printout from an official database. Extracts and printouts from private databases are not accepted. Examples of extracts that are not accepted are DEMAS, MARQUESA, COMPUSERVE, THOMSON, OLIVIA, PATLINK or COMPUMARK, and SAEGIS.

Seniority may only be claimed for an earlier **registration**, not for an earlier application.

The Office must check both that the earlier mark was registered at the time the CTM application was filed and that the earlier registration had not lapsed at the moment the claim was made (on the duration of protection of national marks see the Guidelines, Part C, Opposition, Section 1, Procedural Matters).

If the earlier registration had lapsed at the moment the claim was made, seniority cannot be claimed, even if the relevant national trade mark law provides for a six-month 'grace' period for renewal. While some national legislation allows for a grace period, if the renewal is not paid, the mark is considered to be not registered from the day it was due for renewal. Therefore, the claim is not acceptable, unless the applicant shows that it has renewed the earlier registration(s).

The seniority claimed for the Community trade mark will lapse if the earlier trade mark the seniority of which is claimed is declared to have been revoked or to be invalid or if it is surrendered prior to the registration date of the Community trade mark (Article 34(3) CTMR).

In the context of an **enlargement** of the EU, the following details have to be borne in mind. Where a national trade mark of, or an international registration with effect in, a new Member State was registered before the seniority claim is made, **seniority may be claimed even though the priority, filing or registration date of the CTM to which the seniority claim relates predates the priority, filing or registration date of the national mark/IR with effect in the new Member State**. This is because the CTM at

issue only has effect in the new Member State from the date of accession. The national trade mark/IR with effect in the new Member State for which seniority is claimed is therefore 'earlier' than the CTM within the sense of Article 35 CTMR, **provided** the national trade mark/IR with effect in the new Member State enjoys a priority, filing or registration date **prior to the accession date**.

Examples of acceptable seniority claims for new Member States			
CTM	Filing date	Seniority claim country	Filing date of earlier right
2 094 860 TESTOCAPS	20/02/2001	Cyprus	28/02/2001
2 417 723 PEGINTRON	19/10/2001	Hungary	08/11/2001
352 039 REDIPEN	02/04/1996	Bulgaria	30/04/1996
7 073 307 HydroTac	17/07/2008	Croatia	13/10/2009

Explanation: In all cases, although the filing date of the CTM application is earlier than the filing date of the mark for which seniority is claimed, as all countries concerned acceded to the European Union after the filing date of the CTM application (i.e. on 01/05/2004 for Cyprus and Hungary and on 01/01/2007 for Bulgaria and Romania) and it is from that date that the CTM application has protection in those Member States, seniority can be claimed for any national marks filed prior to the date of accession.

If the claim to seniority is in order, the Office will accept it and — once the CTM application has been registered — inform the relevant central industrial property office(s) of the Member State(s) concerned (Rule 8(3) CTMIR).

Seniority can also be claimed after the CTM is registered under Article 35. For further details, see the Guidelines, Part E, Register Operations, Section 1, Changes in a Registration.

17.3 Identity of the marks

Examination of seniority claims is limited to the formal requirements and to the identity of the marks (see Communication of the President No 2/00 of 25/02/2000).

As regards the triple-identity requirement (same owner, same mark, same goods and services), it is for the applicant to ensure that these requirements are met. The Office will examine only whether the marks are the same.

The comparison of the mark representations for the purposes of seniority claims is the same as that for priority claims detailed above in paragraph 15.2.1.

17.4 Goods and services

Applicants may claim seniority for part of the goods and services of the earlier registration(s). Effectively, the claim to seniority will be valid to the extent that there is an overlap between the goods and services of the CTM application and the registration relied on. The applicant is not required to specify those goods and services, but may simply claim 'seniority for all the goods that are found in the earlier mark to the extent they are also found in the CTM application' (generic seniority claim).

17.5 Treatment of seniority examination deficiencies





If the claim is not valid, the earlier registration is not identical to the CTM application, the seniority is claimed out of time (i.e. after the two-month time limit following the filing of the CTM application) or the seniority documents are not acceptable and the relevant information cannot be found online, the Office will issue a deficiency letter.

If the deficiencies are not remedied within the time limit set by the Office, the applicant will be notified in writing of the loss of rights. At the same time the applicant will be informed that it can ask for a formal decision within two months of the notification.

If the applicant formally requests a decision within the time limit, the Office will issue a formal decision on the rejection of the seniority claim.

17.6 Examples of seniority claims

Example of an acceptable seniority claim (for formalities' purposes)	
CTM application (word mark) CELOTAPE	Seniority claim (word mark) Celotape
CTM application (word mark) Daisys Gingerbread	Seniority claim (word mark) Daisy's Gingerbread

Examples of unacceptable seniority claims (for formalities' purposes)	
CMTA: 9 817 735 (figurative mark) 	Seniority Claim (figurative mark) 
CTM application (word mark) Great changes in education PLC	Seniority claim (word mark) Grate changes in education PLC
CTM application 8 786 485 (figurative mark) 	Seniority claim (figurative mark) 

For further examples of acceptable and unacceptable seniority claims, see paragraph 15.8.2 above.

18 Transformation

Transformation is a legal feature introduced in the Madrid Protocol to soften the consequences of the five-year dependency period between the international registration and the basic mark. In the event that the international registration designating the EU is cancelled at the request of the office of origin in respect of all or some of the goods and services, the holder of the international registration may file a CTM application for the registration of the same mark in relation to the goods and services that have been cancelled. That application will be treated as if it had been filed on the date of the designation of the EU in the international registration and will enjoy the same priority, if any. For more details on transformation, see the Guidelines, Part M, International Marks.

19 Amendments to the CTM Application

Articles 43 and 44 CTMR
Rule 3 and Rule 13(a) CTMIR

The applicant may at any time withdraw its CTM application or restrict the list of goods and services covered by it. Other changes are only foreseen to correct certain mistakes.

Any change requested on the same day of filing of the CTM application will be accepted.

This part of the Guidelines will only describe the Office practice concerning amendments of the mark representation. For further details on withdrawal or restrictions, see the Guidelines, Part B, Examination, Section 1, Proceedings.

19.1 Amendments to the representation of the mark

The Office's practice on amendments of the mark representation is very strict. The two conditions for allowing a change to the mark once filed are cumulative:

- the mistake must be obvious, **and**
- the amendment must not substantially change the mark as filed.

Even if the amendment is not a substantial one, if the mistake is not obvious, the Office will not accept the amendment.

In cases where the desired positioning of a mark is not obvious, the representation of the mark must indicate the correct position by adding the word 'top' to the reproduction of the sign. Where the application is filed by electronic means, the unusual positioning may be indicated in the mark description.

In cases where the desired positioning of a mark is not obvious (e.g. a mark containing a verbal element is filed in a vertical position) and there is no indication of the intended positioning in the application, the applicant will be allowed to amend the position of the mark upon request. This is because the unusual positioning of the mark will be considered an obvious mistake.



If a priority or seniority claim is filed at the same time as the CTM application, an obvious error may be proven by comparing the 'correct' mark in the claim with the mark on the CTM application. However, if the priority or seniority claim is filed after the CTM application, no evidence from these claims can be taken into account.

If the mistake is obvious, the mark must then be assessed by the next criterion, namely whether the requested change substantially alters the mark as filed.

Example of an acceptable amendment (for formalities' purposes)	
CTM 546 010 Mark filed as 'TOPFLOW'	Proposed change 'TOP FLOW'
In the application form, the applicant claimed priority for the mark 'TOP FLOW', meaning that it was obvious that a typographical error had been made. The amendment was not considered to be a substantial alteration of the mark as the addition of a space between the words 'TOP' and 'FLOW' does not alter the meaning and pronunciation of the mark and the visual impact of the amendment is low (decision of 05/08/2002, R 0851/1999-2, TOP FLOW)	

Examples of unacceptable amendments (for formalities' purposes)	
CTM 321 109 Mark filed as 'RANIER'	Proposed change 'RAINIER'
This change will not be allowed since the correction shows the addition of another letter 'I', which would substantially change the mark as filed. 'RANIER' and 'RAINIER' are two different words.	
CTM 6 013 668 Mark filed as 'ELECTROLITIC BOLUS'	Proposed change 'ELECTROLITYC BOLUS'
This change will not be allowed as the correct English spelling for this word is 'ELECTROLYTIC'. Consequently the mark as filed had one erroneous letter whilst the amendment proposal would have two erroneous letters. This would substantially alter the mark and therefore is unacceptable.	

In the case of figurative elements, only elements of minor importance can be amended and this will be dealt with on a case-by-case basis. Giving a 'fresh look' to a figurative mark (this is a frequent practice in the industry to adapt the appearance of a figurative mark to current design and fashion trends from time to time) will not be allowed.

<p>CTM 6 538 524</p> <p>CTM as filed</p> 	<p>Proposed change</p> 
<p>The applicant filed a priority claim with the CTM application which showed that the first filing consisted of the single representation of the mark. In addition, the CTM application contained a mark description that described the single representation and not the two images that had been filed. Therefore, the mistake was considered to be obvious. The amendment request was, however, rejected as the amendment would substantially change the mark from that which was filed.</p>	

Notwithstanding the aforementioned principles and examples, any alteration of the mark that would be allowable after registration will also be allowable in respect of a CTM application.

Regarding alterations of a registered CTM, please refer to the Guidelines, Part E, Register Operations, Section 1, Changes in a Registration.

20 Conversion

Articles 112(1) and 113(1) CTMR
Rule 44(1)(f) CTMIR

The applicant of a CTM application or proprietor of a registered CTM may request the conversion of its CTM application or registered CTM. For more information on conversion see the Guidelines, Part E, Section 2, Conversion.

Annex 1:

Required format for seniorities

<p>Color key</p> <ul style="list-style-type: none"> Registration number Complete as per example Please give year 	<ul style="list-style-type: none"> Complete with given letter Complete if value is given Unused or undefined box (for the moment) 	<p> Zeros must added in front if the registration number of digits is lower than expected.</p>
--	--	--

AT Example: 0 0 0 2 9 1 A
Position: 1 2 3 4 5 6 7 8 9 10 11 12 13

AT: The number could be followed by one letter (A, B, C ... representing the first, second ... partial transfer)

BG Example: B 0 0 0 0 3 6 5 5 Y A S T
Position: 1 2 3 4 5 6 7 8 9 10 11 12 13

BG: If there is, the first letter indicates it is a 'mirror entry' in the Bulgarian registry. In that case the number ends also with 'ST' (which stands for 'seniority'). The number could be followed by one or two letters before the letters ST: letter 'Y' was used until 1999 to differentiate trade marks registered only for services AND/OR letter A, B, C, D ... indicates a partial transfer of the trade mark.

BX Example: 1 9 2 8 6 9 7
Position: 1 2 3 4 5 6 7 8 9 10 11 12 13
Since 1971

CY Example: 6 5 3 1 4
Position: 1 2 3 4 5 6 7 8 9 10 11 12 13

CZ Example: 6 1 3 1 5 9 A
Position: 1 2 3 4 5 6 7 8 9 10 11 12 13

CZ: The number could be followed by one letter (A, B, C ... representing the first, second, third ... partial transfer)

DE Example: D D 6 5 2 3 8 4
Position: 1 2 3 4 5 6 7 8 9 10 11 12 13
Used in GDR only

DE: The first two positions must always be two 'D' followed by the digits in the number.

DE Example: 6 1 3 5 2 3
Position: 1 2 3 4 5 6 7 8 9 10 11 12 13
Until 10/1994

DE Example: 3 9 5 0 1 3 2 5
Position: 1 2 3 4 5 6 7 8 9 10 11 12 13
From 1994 to 2007

DE: The first position must always be '3', the next obligatory 2 positions identify the year 'yy' followed by 5 obligatory digits (zeros must be added in front if the number has less than 5 digits). If number ends with a 'dot' and a 'number' then delete both.

DE Example: 3 0 2 0 1 1 0 1 3 3 6 0
Position: 1 2 3 4 5 6 7 8 9 10 11 12 13
Since 2008

DE: The first 2 positions must always be '3' and '0', the next obligatory 4 positions identify the year 'yyyy' followed by 6 obligatory digits (zeros must be added in front if the number has less than 6 digits). If number ends with a 'dot' and a 'number' then delete both.

DK Example: V R 2 0 1 0 0 0 3 8 2
Position: 1 2 3 4 5 6 7 8 9 10 11 12 13
Since 1894

DK: The first 3 positions must always be 'VR' (registered individual trade mark), 'VG' (registered regular trade mark in old law), or 'FR' (registered collective trade mark) AND a space ' ', the next obligatory four positions identify the year 'yyyy' followed by a space ' ', followed by 5 obligatory digits (zeros must be added in front if the number has less than 5 digits).

EE Example: 0 1 3 1 5
Position: 1 2 3 4 5 6 7 8 9 10 11 12 13

ES Example: M 0 0 0 0 3 6 5 B 1
Position: 1 2 3 4 5 6 7 8 9 10 11 12 13
Since 10/03/1982

ES: The first position must always be 'M', the next obligatory seven digits identify the registration identifier (zeros must be added in front if the number has less than 7 digits), followed by a letter 'B', 'C', 'D' ... and a number if there are and used in case of partial transfer / division.

FI Example: 2 5 0 8 4 1 E
Position: 1 2 3 4 5 6 7 8 9 10 11 12 13

FI: The number could be followed by one letter (A, B, C ... representing the first, second, third ... partial transfer/division)

FR Example: 1 8 5 8 0 0 4
Position: 1 2 3 4 5 6 7 8 9 10 11 12 13
From 1976 to 1991 and as from 2000

FR Example: 9 2 4 5 6 8 0 1
Position: 1 2 3 4 5 6 7 8 9 10 11 12 13
From 1992 to 1999

FR: Two obligatory positions which identify the year 'yy' followed by 6 obligatory digits

GB Example: 4 1 1 0 0 2 3 A
Position: 1 2 3 4 5 6 7 8 9 10 11 12 13

GB: The number could be followed by one letter (A, B, C ..., depending on how many parts - used in case the ID is divided).

GR Example: 2 5 1 1 1 2
Position: 1 2 3 4 5 6 7 8 9 10 11 12 13

HR Example: Z 9 5 0 0 3 2
Position: 1 2 3 4 5 6 7 8 9 10 11 12 13
Until 2000

HR Example: Z 2 0 0 0 1 0 2 2
Position: 1 2 3 4 5 6 7 8 9 10 11 12 13
From 2000

HR: The first position must always be 'Z', the next obligatory positions identify the year (2 or 4 digits) followed by 4 obligatory digits.

HU Example: 0 2 0 8 6 9
Position: 1 2 3 4 5 6 7 8 9 10 11 12 13

IE Example: 7 7 0 8 6 9 B
Position: 1 2 3 4 5 6 7 8 9 10 11 12 13
Since 1989

IE: The number could be followed by one letter.

IT Example: 0 0 0 1 3 7 5 2 6 2
Position: 1 2 3 4 5 6 7 8 9 10 11 12 13

LT Example: 3 4 6 8 8 A
Position: 1 2 3 4 5 6 7 8 9 10 11 12 13
Since 10/1993

LT: The number could be followed by one letter (A, B, C ... representing the first, second, ... partial transfer)

LV Example: M 1 0 1 2 6
Position: 1 2 3 4 5 6 7 8 9 10 11 12 13
Since 1992

LV: The first two positions must always be 'M', and a space ' ', the next two positions are obligatory (zeros must be added in front if the number has less than 2 digits) and are followed by a space ' '. The last 3 positions are obligatory (zeros must be added in front if the number has less than 3 digits).

MT Example: 4 5 6 8
Position: 1 2 3 4 5 6 7 8 9 10 11 12 13
Since 05/1900

PL Example: 1 7 4 8 4 6
Position: 1 2 3 4 5 6 7 8 9 10 11 12 13
Since 28/12/1918

PL: Only the number must appear (letters or characters must NOT be considered)

PT Example: 5 5 1 1 1
Position: 1 2 3 4 5 6 7 8 9 10 11 12 13

RO Example: 0 4 8 9 0 3 A
Position: 1 2 3 4 5 6 7 8 9 10 11 12 13

RO: If there are, the first 2 positions (one digit and/or letter 'R' e.g. '2R') must NOT be considered. The number could be followed by one letter (A, B, C ... representing the first, second, third ... partial transfer).

SE Example: 6 9 2 5 6 6
Position: 1 2 3 4 5 6 7 8 9 10 11 12 13

SI Example: 9 9 7 5 6 8 0
Position: 1 2 3 4 5 6 7 8 9 10 11 12 13
Until 1999

SI: Two obligatory digits which identify the year of registration 'yy' followed by the number (a value greater or equal than 70000).

SI Example: 2 0 0 0 8 5 6 8 0
Position: 1 2 3 4 5 6 7 8 9 10 11 12 13
Since 2000

SI: Four obligatory digits which identify the year of registration 'yyyy' followed by the number (a value greater or equal than 70000).

SK Example: 1 3 3 1 9 6 F
Position: 1 2 3 4 5 6 7 8 9 10 11 12 13

SK: The number could be followed by one letter (A, B, C ... representing the first, second ... partial transfer).

INTERNATIONAL REGISTRATION (WIPO)

Example: 0 1 6 5 7 1 2 B
Position: 1 2 3 4 5 6 7 8 9 10 11 12 13

If there are, the first 2 positions (one digit and/or letter 'R' e.g. '2R') must NOT be considered. The number could be followed by one letter A, B, C, ... indicating that the IR was subject to a partial transfer ('partial assignment' in the language of the Madrid Agreement)

***GUIDELINES FOR EXAMINATION IN THE
OFFICE FOR HARMONIZATION IN THE
INTERNAL MARKET (TRADE MARKS AND
DESIGNS) ON COMMUNITY TRADE MARKS***

PART B

EXAMINATION

SECTION 4

ABSOLUTE GROUNDS FOR REFUSAL

1	General Principles	5
1.1	Reasoned objection	5
1.2	Dialogue with the applicant	5
1.3	Decision	6
	European criteria	7
1.5	Irrelevant criteria	7
1.5.1	Term not used	8
1.5.2	Need to keep free	8
1.5.3	Factual monopoly	8
1.5.4	Double meaning	8
1.6	Scope of objections on the goods and services	9
1.7	Timing of objections	10
1.8	Disclaimers	10
2	Absolute Grounds (Article 7 CTMR)	11
2.1	Article 7(1)(a) CTMR	11
2.1.1	General remarks	11
2.1.2	Examples of trade mark applications refused or accepted under Article 7(1)(a) CTMR	13
2.1.2.1	Smell/olfactory marks	13
2.1.2.2	Taste marks	14
2.1.2.3	Sound marks	14
2.1.2.4	Movement marks	16
2.1.2.5	Colour marks	18
2.1.2.6	Position mark	19
2.1.2.7	3D representation of a space	20
2.1.3	Relationship with other CTMR provisions	20
2.2	Distinctiveness (Article 7(1)(b) CTMR)	20
2.2.1	General remarks	20
2.2.2	Word elements	21
2.2.3	Titles of books	22
2.2.4	Colours	23
2.2.4.1	Single colours	23
2.2.4.2	Colour combinations	24
2.2.5	Single letters	25
2.2.5.1	General considerations	25
2.2.5.2	Examples	26
2.2.6	Slogans: assessing distinctive character	27
2.2.7	Simple figurative elements	31
2.2.8	Commonplace figurative elements	32
2.2.9	Typographical symbols	32
2.2.10	Pictograms	33
2.2.11	Common/non-distinctive labels	34
2.2.12	Three-dimensional trade marks	35
2.2.12.1	Preliminary remarks	35
2.2.12.2	Shapes unrelated to the goods or services themselves	36
2.2.12.3	Shape of the goods themselves or shapes related to the goods or services	36
2.2.12.4	Shape of the packaging	41

2.2.13	Pattern marks	42
2.2.14	Position marks	46
2.2.15	Sound marks.....	47
2.3	Descriptiveness (Article 7(1)(c) CTMR).....	49
2.3.1	General remarks	49
2.3.1.1	The notion of descriptiveness	49
2.3.1.2	The reference base	49
2.3.1.3	Characteristics mentioned under Article 7(1)(c) CTMR	51
2.3.2	Word marks	52
2.3.2.1	One word.....	52
2.3.2.2	Combinations of words	53
2.3.2.3	Misspellings and omissions	56
2.3.2.4	Abbreviations and acronyms	57
2.3.2.5	Slogans	58
2.3.2.6	Geographical terms	59
2.3.2.7	Terms describing subject matter in goods or services.....	63
2.3.2.8	Single letters and numerals	66
2.3.2.9	Names of colours	68
2.3.2.10	Plant variety names.....	68
2.3.2.11	Names of banks and newspapers/magazines	70
2.3.2.12	Names of hotels	70
2.3.2.13	Combinations of names of countries/cities with a number indicating a year	71
2.3.2.14	INN codes.....	71
2.3.3	Figurative marks	72
2.3.4	Figurative threshold	73
2.3.4.1	Preliminary remarks	73
2.3.4.2	Assessment of the figurative threshold.....	74
2.4	Customary signs or indications (Article 7(1)(d) CTMR).....	79
2.4.1	General remarks	79
2.4.2	Point in time of a term becoming customary	80
2.4.3	Assessment of customary terms	80
2.4.4	Applicability of Article 7(1)(d) CTMR in relation to plant variety names	81
2.5	Shapes with an essentially technical function, substantial aesthetic value or resulting from the nature of the goods (Article 7(1)(e) CTMR).....	81
2.5.1	General remarks	81
2.5.2	Shape that results from the nature of the goods	83
2.5.3	Shape of goods necessary to obtain a technical result.....	84
2.5.4	Shape that gives substantial value to the goods	86
2.6	Acquired distinctiveness	88
2.6.1	Introduction	88
2.6.2	Request	88
2.6.3	The point in time	88
2.6.3.1	Examination proceedings	88
2.6.3.2	Cancellation Proceedings.....	89
2.6.4	Consumer	89
2.6.5	Goods and Services	90
2.6.6	Territorial Aspects.....	90
2.6.6.1	Special provisions with respect to the accession of new Member States..	91
2.6.6.2	3D marks, colours per se and figurative trade marks	91
2.6.6.3	Language area	91
2.6.6.4	Extrapolation	92
2.6.7	Standard of proof.....	94

2.6.8	Assessment of the evidence.....	95
2.6.8.1	Opinion polls and surveys	96
2.6.8.2	Market share, advertising and turnover	97
2.6.8.3	Declarations, affidavits and written statements	97
2.6.8.4	Prior registrations on acquired distinctiveness	98
2.6.8.5	Other means of evidence	98
2.6.8.6	Manner of use	99
2.6.8.7	Length of use.....	99
2.6.8.8	Post-filing date evidence	100
2.6.9	Consequences of Acquired Distinctiveness	100

1 General Principles

1.1 Reasoned objection

When there is an absolute ground for refusal, a reasoned objection will be issued that specifies the individual grounds for refusal and provides clear and distinct reasoning for each ground separately. Piecemeal objections (so-called step-by-step objections) should be avoided.

Each of the grounds for refusal listed in Article 7(1) CTMR is independent of the others and calls for separate examination.

Even when some grounds for refusal overlap, each ground of refusal must be given separate reasoning in the light of the general interest underlying each of them.

For example, where a word mark is found to have a semantic meaning that makes it objectionable under both Article 7(1)(b) and (c) CTMR, the notification of grounds of refusal should deal with each of these grounds in separate paragraphs. In such a case, it will be clearly indicated whether the lack of distinctiveness arises out of the same, or different, considerations from those that lead to the mark being deemed descriptive.

Any one of the grounds listed in Article 7(1) CTMR is sufficient for refusal of a Community trade mark. However, the Office will list all the grounds for refusal that are applicable at each stage.

Occasionally, arguments brought forward by the applicant, or a restriction (partial withdrawal) of the list of goods and services will lead to the application of other grounds for refusal. In these cases, the party will always be given the opportunity to comment thereon.

1.2 Dialogue with the applicant

During examination proceedings, the Office will seek a dialogue with the applicant.

At all stages of the proceedings, the observations submitted by the applicant will be considered carefully.

The Office will likewise consider, of its own motion, new facts or arguments that plead in favour of acceptance of the mark. The application can only be refused if the Office is convinced that the objection is well founded at the point in time when the decision is taken.

If several grounds for refusal are raised, the applicant must overcome all of them, since a refusal can be based on a single ground for refusal (judgment of 19/09/2002, C-104/00 P, Companyline, EU:C:2002:506, § 28).

- No observations submitted by the applicant

Where the applicant has not submitted any observations, if the application is to be refused, the notification to the applicant will include the original objection letter(s), state that the application is 'hereby refused', and contain a notice on the availability of an appeal.

- Observations submitted by the applicant

If the applicant contests the reasons given in the original notification, the refusal will first provide the original reasoning given, and then address the arguments of the applicant.

Where the Office needs to provide new facts or arguments to sustain a refusal, the applicant must be given the opportunity of commenting on these before a final decision is taken.

- Restriction of goods and services

Where the applicant tries to overcome the objection by restricting the list of goods and services, it is possible that the restriction may give rise to a new ground for refusal, for example, deceptiveness in addition to descriptiveness. In this case another objection letter will be issued, so as to give the applicant the opportunity to comment on all grounds for refusal found pertinent.

A specification of goods or services that is restricted by a condition that the goods or services do not possess a particular characteristic should not be accepted (judgment of 12/02/2004, C-363/99, Postkantoor, EU:C:2004:86, § 114). For example, in respect of the trademark 'Theatre', a specification claiming '*books, except for books about theatre*' should not be accepted. In contrast, restrictions that are worded in a positive way are usually acceptable, such as 'books about Chemistry'.

- Proof of acquired distinctiveness

As regards the proof of acquired distinctiveness (Article 7(3) CTMR), the applicant has the right to claim that its mark has acquired distinctiveness through use and submit the relevant proof of use.

The point in time where the applicant must send its proof of use is after the objection letter and before the final decision is taken by the Office. In that regard, the applicant may file a request for an extension of time limits after the objection letter pursuant to Rule 71 CTMIR.

If the mark is accepted on the basis of Article 7(3) CTMR, then no refusal letter will be sent.

If the proof of use does not demonstrate acquired distinctiveness, the refusal will contain the reasoning as to why the mark falls foul of any of the grounds mentioned in Article 7(1) CTMR and separate reasoning as to why the applicant's claim of acquired distinctiveness has failed.

1.3 Decision

After the dialogue with the applicant has taken place, the Office will take a decision to refuse the application if it considers that the objection is well founded despite the facts and arguments submitted by the applicant.

The decision will include the original objection, summarise the applicant's arguments, address the applicant's arguments and submissions, and give reasons and a detailed explanation as to why they are not convincing.

If the applicant has submitted evidence of acquired distinctiveness by use and this is considered **sufficient** to overcome the objection, then the Office will issue a communication that rebuts any new argument raised by the applicant and maintains the objection(s), but accepts the trade mark based on the acquisition of distinctiveness by use. If the evidence is **not considered sufficient**, a decision will be issued. It will contain a separate reasoning on the claim of acquired distinctiveness.

The objection can be waived in part if the Office considers that (i) **some** of the grounds have been overcome or (ii) **all** grounds have been overcome for some of the goods and services.

The decision will state that the application has been refused (either in its entirety or partly, with an indication of the rejected goods and services) and will contain a notice of the availability of an appeal.

1.4 European criteria

Article 7(1) CTMR is a European provision and has to be interpreted on the basis of a common European standard. It would be incorrect to apply different standards of distinctiveness, based on different national traditions, or to apply different (i.e. more lenient or stricter) standards on the breach of public order or morality, depending on the country concerned.

However, Article 7(2) CTMR excludes an application from registration if a ground for refusal pertains in only part of the European Union ('EU').

That means that it suffices for a refusal if the trade mark is descriptive, or lacks distinctive character, in any official language of the EU (judgment of 03/07/2013, T-236/12, Neo, EU:T:2013:343, § 57).

As regards other languages, a refusal will be raised if the trade mark is objectionable under Article 7(1) CTMR in a language understood by a significant section of the relevant public in at least a part of the European Union (see below under paragraph 2.3.1.2. The reference base, and judgment of 13/09/2012, T-72/11, Espetec, EU:T:2012:424, § 35-36).

Where the objection is not based on a semantic meaning of a word, the ground for refusal will normally pertain to the European Union as a whole. However, the perception of the sign by the relevant public, the practice in trade, or the use of the goods and services claimed may be different in some parts of the European Union.

1.5 Irrelevant criteria

Applicants often advance arguments that have already been declared irrelevant by the courts. These arguments should be rejected and the corresponding passages of the applicable judgments cited.

1.5.1 Term not used

The fact that a descriptive use of the term applied for cannot be ascertained is irrelevant. Examination of Article 7(1)(c) CTMR has to be made by means of prognostics (assuming that the mark will be used with respect to the goods or services claimed). It follows clearly from the text of Article 7(1)(c) CTMR that it suffices if the mark 'may serve' to designate characteristics of the goods and services (judgment of 23/10/2003, C-191/01 P, Doublemint, EU:C:2003:579, § 33).

1.5.2 Need to keep free

It is frequently claimed that other traders do not need the term applied for, can use more direct and straightforward indications or have synonyms at their disposal to describe the respective characteristics of the goods. All these arguments must be refused as irrelevant.

Although there is a public interest underlying Article 7(1)(c) CTMR that descriptive terms should not be registered as trade marks so as to remain freely available to all competitors, it is not necessary for the Office to show that there is a present or future need or concrete interest of third parties to use the descriptive term applied for (no 'konkretes Freihaltebedürfnis') (judgments of 04/05/1999, C-108/97 and C-109/97, Chiemsee, EU:C:1999:230, § 35; 12/02/2004, C-363/99, Postkantoor, EU:C:2004:86, § 61).

Whether there are synonyms or other even more usual ways of expressing the descriptive meaning is thus irrelevant (judgment of 12/02/2004, C-265/00, Biomild, EU:C:2004:87, § 42).

1.5.3 Factual monopoly

The fact that the applicant is the only person offering the goods and services for which the mark is descriptive is not relevant for Article 7(1)(c) CTMR. However, in this case the applicant will be more likely to succeed on acquired distinctiveness.

1.5.4 Double meaning

The frequent argument of applicants that the terms applied for have more than one meaning, one of them not being descriptive for the goods/services, should be rejected. It suffices for a refusal under Article 7(1)(c) CTMR if at least one of the possible meanings of the term is descriptive in relation to the relevant goods and services (judgment of 23/10/2003, C-191/01 P, Doublemint, EU:C:2003:579, § 32; confirmed by judgment of 12/02/2004, C-363/99, Postkantoor, EU:C:2004:86, § 97).

Given that the examination must focus on the goods/services covered by the application, arguments concerning other possible meanings of the word/s making up the trade mark applied for (which are unrelated to the goods/services concerned) are irrelevant. Equally, when the trade mark applied for is a composite word mark, what matters for examination purposes is the meaning, if any, associated with the sign considered as a whole, and not the possible meanings of its individual elements considered separately (judgment of 08/06/2005, T-315/03, Rockbass, EU:T:2005:211, § 56).

1.6 Scope of objections on the goods and services

Almost all absolute grounds for refusal, and in particular the most pertinent ones of lack of distinctiveness, descriptiveness, genericness and deceptiveness, have to be assessed with respect to the goods and services actually claimed.

If an objection is raised, the Office must state specifically which ground (or grounds) for refusal apply to the mark in question, for each product or service claimed.

It is sufficient that a ground for refusal applies to a single homogenous category of goods and/or services. A homogenous category is considered a group of goods and/or services that have a sufficiently direct and specific link to each other (judgment of 02/04/2009, T-118/06, Ultimate fighting championship, EU:T:2009:100, § 28). Where the same ground or grounds for refusal is/are given for a category or group of goods or services, only general reasoning for all of the goods and/or services concerned may be used (judgment of 15/02/2007, C-239/05, The Kitchen Company, EU:C:2007:99, § 38).

Sign	Case number
BigXtra	C-253/14 P
The Court confirmed the refusal in respect of goods and services in Classes 16, 35, and 41 to 43 by means of a general reasoning because of a sufficiently concrete and direct link for all these goods and services. For all of them, 'BigXtra' will be perceived as indicating price reductions or other advantages (para. 48).	
Sign	Case number
PIONEERING FOR YOU	T-601/13
The Court allowed general reasoning in respect of goods and services in Classes 7, 9, 11, 37 and 42 because the promotional meaning of the sign applied for would be perceived identically for each of them (paras 36-37).	

As regards descriptiveness, an objection applies not only to those goods/services for which the term(s) making up the trade mark applied for is/are directly descriptive, but also to the broad category that (at least potentially) contains an identifiable subcategory or specific goods/services for which the mark applied for is directly descriptive. In the absence of a suitable restriction by the applicant, the descriptiveness objection necessarily affects the broad category as such. For example, 'EUROHEALTH' is to be refused for 'insurances' as a whole and not only for health insurances (judgment of 07/06/2001, T-359/99, EuroHealth, EU:T:2001:151, § 33).

An objection also arises for those goods and services that are directly linked to those for which the descriptive meaning pertains. Furthermore, if the descriptive meaning applies to an activity involving the use of several goods or services mentioned separately in the specification, then the objection arises for all of them (see judgment of 20/03/2002, T-355/00, Tele Aid, EU:T:2002:79, for a number of goods and services that are in conjunction with, or are applied in, offering aid to car drivers at a distance).

It is possible to claim goods and services as so-called auxiliary goods or services in the sense that they are meant to be used with, or support the use of, the main goods or services. Typically, this covers paper and instruction manuals for the goods to which they belong or which are packed in them, advertisement or repair. In these cases, the auxiliary goods are by definition intended to be used and sold together with the main product (e.g. vehicles and instruction manuals). It follows that if the CTM is found to be descriptive of the main goods, logically it is also descriptive of the auxiliary goods which are so closely related.

1.7 Timing of objections

Objections should be raised as early as possible. In the majority of cases, the Office raises its objection *ex officio* before the publication of the CTMA.

In any event, the Office can reopen examination of the CTMA at any time before registration, that is to say, even after publication (judgment of 08/07/2004, T-289/02, Telepharmacy Solutions, EU:T:2004:227, § 60), for example:

- when the Office receives **observations from third parties** relating to the existence of an absolute ground for refusal. The Office can then decide to reopen the examination procedure as a result of these observations (Article 40 CTMR). See the Guidelines, Part B, Examination, Section 1, Proceedings, paragraph 3.1.
- in rare cases where the mark **had been clearly published by mistake**.

In the case of international registrations designating the EU, the Office can raise an objection as long as the opposition period (six months after republication) has not started (Rule 112(5) CTMIR) and any interim status declaration previously sent would be revoked.

1.8 Disclaimers

Article 37(2) CTMR allows for the possibility of the Office requesting, as a condition of registration, that an element of a mark that is not distinctive should be disclaimed. In practice, the Office will generally avoid recourse to this provision.

Provided a mark is judged to be neither exclusively descriptive nor devoid of distinctive character, it will generally be accepted without a disclaimer.

As a general rule, a disclaimer will not help to overcome an absolute grounds objection.

Where a trade mark consists of a combination of elements, each of which in itself is clearly not distinctive, there is no need for a disclaimer of the separate elements. For example, if a periodical had as its trade mark ‘Alicante Local and International News’ with a figurative distinctive element, the individual word elements within it would not need to be disclaimed.

If the applicant’s disclaimer does not overcome the ground for refusing registration or the applicant does not agree to the condition, then the application must be refused to the extent that is required.

Where the applicant has made a disclaimer of a non-distinctive element in its application, the disclaimer should stay even if the Office does not consider it

necessary. **Disclaimers of distinctive elements must be refused by the Office** since they would result in a trade mark with an unclear scope of protection.

The following paragraphs address each individual subsection of Article 7(1) CTMR in alphabetical order, beginning with Article 7(1)(a) CTMR and ending with Article 7(1)(e) CTMR. This is followed by a paragraph regarding Article 7(3) CTMR (acquired distinctiveness).

The second part addresses the remaining individual subsections of Article 7(1) CTMR from Article 7(1)(f) to (k) CTMR and ends with a paragraph covering collective marks.

2 Absolute Grounds (Article 7 CTMR)

2.1 Article 7(1)(a) CTMR

2.1.1 General remarks

Article 7(1)(a) CTMR reflects the Office's obligation to refuse signs that do not conform to the requirements of Article 4 CTMR.

According to Article 4 CTMR, a Community trade mark may consist of any sign capable of being represented graphically, particularly words, including personal names, designs, letters, numerals, the shape of goods and their packaging, provided that such signs are capable of distinguishing the goods or services of one undertaking from those of other undertakings.

To be capable of constituting a trade mark for the purposes of Article 4 CTMR, the subject matter of an application must satisfy three conditions:

- (a) it must be a sign,
 - (b) it must be capable of being represented graphically,
- it must be capable of distinguishing the goods or services of one undertaking from those of others (judgment of 25/01/2007, C-321/03, Transparent bin, EU:C:2007:51, § 28).

a) Signs

According to Article 4 CTMR, a trade mark may consist of any sign, subject to certain conditions. Although the particular examples listed in this provision are all signs that are two- or three-dimensional and are capable of being perceived visually, the list is not exhaustive.

However, in order not to deprive Article 4 CTMR of any substance, this provision cannot be interpreted so broadly as to allow any non-specific subject matter to necessarily qualify as a sign. Thus, abstract concepts and ideas or general characteristics of goods are not specific enough to qualify as a sign, as they could apply to a variety of different manifestations (judgment of 21/04/2010, T-7/09, Spannfutter, EU:T:2010:153, § 25).

For this reason, the Court rejected, for example, an application for a 'transparent collecting bin forming part of the external surface of a vacuum cleaner', as the subject

matter was not a particular type of a bin, but rather, in a general and abstract manner, all conceivable shapes of a transparent bin with a multitude of different appearances (judgment of 25/01/2007, C-321/03, Transparent bin, EU:C:2007:51, § 35, 37).

b) Graphic representation

A sign that is not capable of being represented graphically will be excluded from registration as a Community trade mark under Article 7(1)(a) CTMR.

The function of the requirement of graphic representation is to define the mark itself in order to determine the precise subject matter of the protection afforded by the registered mark to its proprietor.

It has been clearly established by case-law that a graphic representation in terms of Article 2 of the Trade Mark Directive, which corresponds to Article 4 CTMR, must enable the sign to be represented visually, particularly by means of images, lines or characters, and that the representation is clear, precise, self-contained, easily accessible, intelligible, durable and objective (judgment of 12/12/2002, C-273/00, Methylcinnamat, EU:C:2002:748, § 46-55, and judgment of 06/05/2003, C-104/01, Libertel, EU:C:2003:244, § 28-29).

The requirement of ‘objectivity’ means that the sign must be perceived unambiguously and consistently over time in order to function as a guarantee of indication of origin. The object of the representation is specifically to avoid any element of subjectivity in the process of identifying and perceiving the sign. Consequently, the means of graphic representation must be unequivocal and objective.

Moreover, in cases where a sign is defined by both a graphic representation and a textual description, in order for the representation to be precise, intelligible, and objective, it must coincide with what can be seen in the graphic representation (decision of 23/09/2010, R 443/2010-2, RED LIQUID FLOWING IN SEQUENCE OF STILLS (al.)).

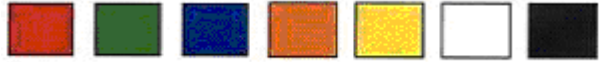
Sign	Case number
 <p data-bbox="236 1496 847 1688"><u>Description:</u> ‘Six surfaces being geometrically arranged in three pairs of parallel surfaces, with each pair being arranged perpendicularly to the other two pairs characterised by: (i) any two adjacent surfaces having different colours and (ii) each such surface having a grid structure formed by black borders dividing the surface into nine equal segments’.</p>	<p data-bbox="916 1496 1315 1581">CTM 8 316 184 14/06/2012, T-293/10, Colour per se, EU:T:2012:302</p>
<p data-bbox="236 1733 1370 1892">The General Court considered that the mark’s description was too difficult to understand. A sign so defined is not a colour mark per se but a three-dimensional mark, or figurative mark, that corresponds to the external appearance of a particular object with a specific form — a cube covered in squares with a particular arrangement of colours. Even if the description had been clear and easily intelligible — which it was not — it would still have contained an inherent contradiction insofar as the true nature of the sign is concerned (paras 64 and 66).</p>	

c) Distinguishing character

Article 4 CTMR refers to the capacity of a sign to distinguish the goods of one undertaking from those of another. Unlike Article 7(1)(b) CTMR, which concerns the distinctive character of a trade mark with regard to specific goods or services, Article 4 CTMR is merely concerned with the abstract ability of a sign to serve as a badge of origin, regardless of the goods or services.

Only in very exceptional circumstances is it conceivable that a sign could not possess even the abstract capacity to distinguish the goods or services of one undertaking from those of another. A conceivable example for the lack of abstract capacity in the context of any goods or services could be, e.g. the word 'Trademark'.

2.1.2 Examples of trade mark applications refused or accepted under Article 7(1)(a) CTMR

For formalities issues regarding some of the types of marks mentioned below, see the Guidelines, Part B, Examination, Section 2, Formalities, paragraph 9.

2.1.2.1 Smell/olfactory marks

The requirements of graphic representation of an olfactory mark are not satisfied by a chemical formula, by a description in written words, by the deposit of an odour sample or by a combination of those elements (judgment of 12/12/2002, C-273/00, Methylcinnamat, EU:C:2002:748, § 69-73).

There is currently no means of graphically representing smells in a satisfactory way. There is no generally accepted international classification of smells that would make it possible, as with international colour codes or musical notation, to identify an olfactory sign objectively and precisely through the attribution of a name or a precise code specific to each smell (judgment of 27/10/2005, T-305/04, Odeur de fraise mûre, EU:T:2005:380, § 34).

The following are examples of possible ways of graphically representing a smell but none is satisfactory:

- *Chemical formula*

Few people would recognise the odour in question from such a formula.

- *Odour sample*

A deposit of an odour sample would not constitute a graphic representation for the purposes of Article 4 CTMR, as an odour sample is not sufficiently stable or durable.

- *Graphic representation and description in word*

The requirements of graphical representation are not satisfied by:

- a graphic representation of the smell
- a description of the smell in words
- a combination of both (graphic representation and description in words).

Sign	Case No
 <p>Mark description: Smell of ripe strawberries</p>	<p>CTMA 1 122 118</p>
<p>27/10/2005, T-305/04, Odeur de fraise mûre, EU:T:2005:380, § 34 The Court considered that the smell of strawberries varies from one variety to another and the description 'smell of ripe strawberries' can refer to several varieties and therefore to several distinct smells. The description was found neither unequivocal nor precise and did not eliminate all elements of subjectivity in the process of identifying and perceiving the sign claimed. Likewise, the image of a strawberry represents only the fruit that emits a smell supposedly identical to the olfactory sign at issue, and not the smell claimed, and therefore does not amount to a graphic representation of the olfactory sign.</p>	

2.1.2.2 Taste marks

The arguments mentioned above under paragraph 2.1.2.1 are applicable in a similar way for taste marks (decision of 04/08/2003, R 120/2001-2, The taste of artificial strawberry flavour (gust.)).

2.1.2.3 Sound marks

According to the judgment of 27/11/2003, C-283/01, Musical notation, EU:C:2003:641, § 55, a sound must be represented graphically 'particularly by means of images, lines or characters' and its representation must be 'clear, precise, self-contained, easily accessible, intelligible, durable and objective'.

The following **are not valid means** to graphically represent a sound:

- *Description of a sound in words*

A description such as certain notes of a musical play, e.g. 'the first 9 bars of *Für Elise*', or a description of the sound in words, e.g. 'the sound of a cockcrow', is not sufficiently precise or clear and therefore does not make it possible to determine the scope of the protection sought (judgment of 27/11/2003, C-283/01, Musical notation, EU:C:2003:641, § 59).

- *Onomatopoeia*

There is a lack of consistency between the onomatopoeia itself, as pronounced, and the actual sound or noise, or the sequence of actual sounds or noises, that it purports to imitate phonetically (judgment of 27/11/2003, C-283/01, Musical notation, EU:C:2003:641, § 60).

- *Musical notes alone*

A sequence of musical notes alone, such as E, D#, E, D#, E, B, D, C, A, does not constitute a graphical representation. Such a description, which is neither clear, nor precise nor self-contained, does not make it possible, in particular, to

determine the pitch and the duration of the sounds forming the melody for which registration is sought and that constitute essential parameters for the purposes of knowing the melody and, accordingly, of defining the trade mark itself (judgment of 27/11/2003, C-283/01, Musical notation, EU:C:2003:641, § 61).

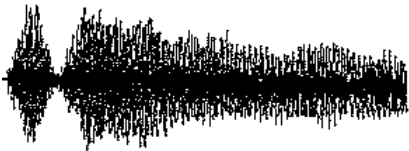
Example of an unacceptable sound mark	
<p style="text-align: center;">CTM 143 891 R 0781/1999-4 ('ROARING LION')</p> <p>The (alleged) sonograph was considered incomplete, as it did not contain a representation of scale of the time axis and the frequency axis (para. 28).</p>	

The following **are valid means** of representing a sound graphically:

- *Musical notations (stave)*

A stave divided into bars and showing, in particular, a clef (a treble, bass, alto or tenor clef), musical notes and rests whose form (for the notes: semibreve, minim, crotchet, quaver, semiquaver, etc.; for the rests: semibreve rest, minim rest, crotchet rest, quaver rest, etc.) indicates the relative value and, where appropriate, accidentals (sharp, flat, natural) – all of this notation determining the pitch and duration of the sounds – constitutes a faithful representation of the sequence of sounds forming the melody in respect of which registration is sought (judgment of 27/11/2003, C-283/01, Musical notation, EU:C:2003:641, § 62).

- *MP3 files with another suitable graphic representation*

The applicant may file one sound file as an attachment to the electronic application form (Decision No EX-05-3 of the President of the Office of 10 October 2005 concerning electronic filing of sound marks, Article 2(2)). However such sound files must be filed together with a suitable graphic representation.

One graphic representation that may be filed along with an electronic file is a sonogram, i.e. a graphical representation of a sound, showing the distribution of energy at different frequencies, especially as a function of time, as long as the diagram itself indicates the scaling, orientation (rotation) and translation of the axes (time and frequency).

Examples of graphical representations which are **acceptable**:

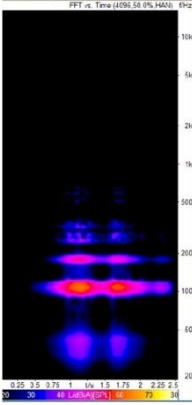
Sign	Reasoning	Case No
	<p>Stave divided into bars and showing, in particular, a clef, musical notes and rests</p>	<p>CTM 1 637 859</p>
	<p>Sonogram indicating time (x-axis), frequency (y-axis) and intensity (in colour), along with an electronic file</p>	<p>CTMA 11 923 554</p>

2.1.2.4 Movement marks

A movement mark **may only be refused** registration under Article 7(1)(a) CTMR when a ‘reasonably observant person with normal levels of perception and intelligence would, upon consulting the CTM register, [not be] able to understand precisely what the mark consists of, without expending a huge amount of intellectual energy and imagination (decision of 23/09/2010, R 443/2010-2, RED LIQUID FLOWING IN SEQUENCE OF STILLS (al.), para. 20).

Therefore, in most cases, in order for the representation of a movement mark to be clear, precise, intelligible, and objective, the graphic representation must be accompanied by a **description**. The description must clearly **explain the movement** for which protection is sought and must be coherent with what can be seen in the representation of the sign.

The **number of stills** will depend on the movement concerned. No limit has been imposed.

Examples of graphical representations that are **acceptable for movement marks**:

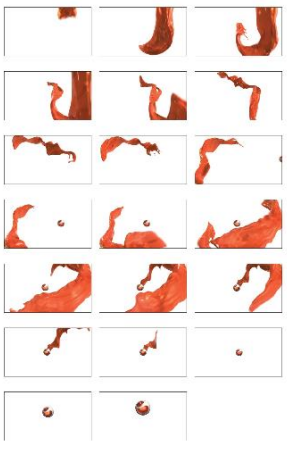
Sign	Case No
	<p style="text-align: center;">CTM 8 581 977 RED LIQUID FLOWING IN SEQUENCE OF STILLS (MOVEMENT MARK)</p> <p style="text-align: center;">R 443/2010 2</p>

Description: This is a motion mark in colour. The nature of the motion is that of a trailing ribbon with a liquid-like appearance ('ribbon'). The ribbon flows around and ultimately into a spherical shape ('sphere'). The motion takes approximately 6 seconds. The stills in the sequence are spaced approximately 0.3 seconds apart and are evenly spaced from the beginning to the end of sequence. The first still is at top left. The last still (20th) is the middle one in the bottom row. The stills follow a progression from left to right within each row, before moving down to the next row. The precise sequence of the stills is as follows: In the 1st still, the ribbon enters the frame in the upper edge of the frame and flows down the right edge of the frame, before flowing upward in the 2nd to 6th stills. During that phase of motion (in the 4th still) the end of the ribbon is shown, producing the effect of a trailing ribbon. In the 6th to 17th stills, the ribbon flows counterclockwise around the frame. From the 9th still onwards, the sphere appears in the centre of the frame. The interior of the sphere is the same colour as the ribbon. The ribbon flows around the sphere. In the 14th still, the ribbon enters the sphere, as if being pulled inside. In the 15th to 17th stills, the ribbon disappears inside the sphere. In the 19th and 20th stills, the sphere moves toward the viewer, gaining in size and ending the motion.

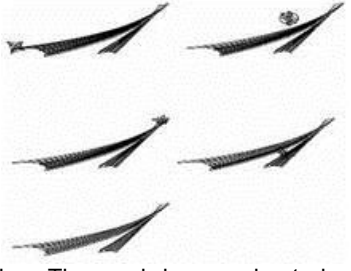
Sign	Case No
 <p>Description: The mark is an animated sequence with two flared segments that join in the upper right portion of the mark. During the animation sequence, a geometric object moves upwards adjacent to the first segment and then downwards adjacent to the second segment, while individual chords within each segment turn from dark to light. The stippling in the mark is for shading only. The entire animated sequence lasts between one and two seconds.</p>	<p style="text-align: center;">CTM 5 338 629</p>

Examples of graphical representations that are **not acceptable for movement marks**:

Sign	Case
 <p data-bbox="233 562 767 696"><u>Description:</u> The mark comprises a moving image consisting of a toothbrush moving towards a tomato, pressing onto the tomato without breaking the skin, and moving away from the tomato.</p>	<p data-bbox="986 450 1155 472">CTM 9 742 974</p>
<p data-bbox="261 712 1334 768">The Office rejected the application as it was not possible to establish the precise movement from the description provided along with the graphic representation</p>	

2.1.2.5 Colour marks

The formless and shapeless combination of two or more colours ‘in any manifestation’ does not satisfy the requirements under the ‘Sieckmann’ and ‘Libertel’ cases regarding the clarity and constancy of a graphical representation, which is a condition for the ability to act as a trade mark (see also decision of 27/07/2004, R 730/2001-4, YELLOW/BLUE/RED(col.)).

The mere juxtaposition of two or more colours, without shape or contours, or a reference to two or more colours ‘in every conceivable form’, does not exhibit the qualities of precision and uniformity required by Article 4 CTMR (judgment of 24/06/2004, C-49/02, Blau/Gelb, EU:C:2004:384, § 34).

Moreover, such representations would allow numerous different combinations, which would not permit the consumer to perceive and recall a particular combination, thereby enabling him to repeat with certainty the experience of a purchase, any more than they would allow the competent authorities and economic operators to know the scope of the protection afforded to the proprietor of the trade mark.

A graphic representation consisting of two or more colours, designated in the abstract, without contours and arranged by associating the colours concerned in a predetermined and uniform way will satisfy the requirement of graphical representation (judgment of 14/06/2012, T-293/10, Colour per se, EU:T:2012:302, § 50).

Example of a sign that is **acceptable**:

Sign	Case number
 <p>Colours indicated: Green, Pantone 368 C, anthracite, Pantone 425 C, orange, Pantone 021 C</p> <p>Description: The trade mark consists of the colours green: Pantone 368 C; anthracite: Pantone 425 C; orange: Pantone 021 C, as shown in the illustration; the colours are applied to a basic component of the exterior of vehicle service stations (petrol stations) in the ratio green 60 %, anthracite 30 % and orange 10 %, creating the impression of a green and anthracite-coloured petrol station (green predominating) with small orange accents.</p>	<p>CTM 8 298 499</p>

2.1.2.6 Position mark

In order to satisfy the requirements of graphical representation and be clear, precise, intelligible, and objective, the mark's representation must be filed with a description. This must indicate that the application is indeed for a position mark and detail its positioning.

The application could be objectionable for some of the goods if the positioning on those goods is unclear.

Examples of graphical representations of a trade mark filed as a position mark:

Sign	Case Number
 <p>Initial description: 'a copper ring between two metal layers, which is visible at the upper rim of the body of a cooking utensil like a pot or a pan'.</p> <p>Final Description: <i>The trade mark is a positional trade mark whereby a narrow copper ring is positioned visibly between two metal layers on the upper rim of the body of a pot or pan.</i></p>	<p>CTM 8 316 184</p>

The Office raised an objection on the basis of Article 7(1)(a) CTMR. The applicant had chosen to apply for an 'other' type of mark. The interpretation of the mark description in combination with the representation of the mark did not allow the Office to understand the scope of the right claimed, i.e. it was not clear what 'a copper ring' was or what 'like a pot or pan' meant. The applicant was requested to file a more precise and detailed mark description.

The description was modified by the applicant during the examination proceedings (see above) and the objection under Article 7(1)(a) CTMR was waived as a consequence of the new description.

2.1.2.7 3D representation of a space

Following the judgment of 10/07/2014, C-421/13, Apple, EU:C:2014:2070, it cannot be excluded that the requirements of graphic representation of the layout of a retail store are satisfied by a design alone, combining lines, curves and shapes, without any indication of the size or the proportions. The Court indicated that in such a case, the trade mark could be registered provided that the sign is capable of distinguishing the services of the applicant for registration from those of other undertakings and if no other grounds for refusal apply.

Sign	Case number
	<p>10/07/2014, C-421/13, Apple, EU:C:2014:2070</p>

2.1.3 Relationship with other CTMR provisions

Article 7(1)(a) CTMR reflects the Office's obligation to refuse signs that do not conform to the requirements of Article 4 CTMR. If the sign does not meet these requirements, there is no acceptable graphical representation and the application will be examined in the light of the other absolute grounds for refusal.

According to Article 7(3) CTMR, the absolute grounds for refusal under Article 7(1)(a) CTMR cannot be overcome through acquired distinctiveness in consequence of the use of the mark.

2.2 Distinctiveness (Article 7(1)(b) CTMR)

2.2.1 General remarks

According to settled case-law, distinctiveness of a trade mark within the meaning of Article 7(1)(b) CTMR means that the sign serves to identify the product and/or services in respect of which registration is applied for as originating from a particular undertaking, and thus to distinguish that product from those of other undertakings (judgments of 29/04/2001, joined cases C-468/01 P to C-472/01 P, Tabs, EU:C:2004:259, § 32; 21/10/2004, C-64/02 P, Das Prinzip der Bequemlichkeit, EU:C:2004:645, § 42; and 08/05/2008, C-304/06 P, Eurohypo, EU:C:2008:261, § 66; and 21/01/2010, C-398/08 P, Vorsprung durch Technik, EU:C:2010:29, § 33).
Guidelines for Examination in the Office, Part B, Examination. Page 20

According to settled case-law, such distinctiveness can be assessed only by reference first to the goods or services in respect of which registration is sought and, second, to the relevant public's perception of that sign (judgments of 29/04/2001, joined cases C-468/01 P - C-472/01 P, *Tabas*, EU:C:2004:259, § 33; of 08/05/2008, C-304/06 P, *Eurohypo*, EU:C:2008:261, § 67; and of 21/01/2010, C-398/08 P, *Vorsprung durch Technik*, EU:C:2010:29, § 34) (judgments of 14/06/2012, T-293/10, *Colour per se*, EU:T:2012:302; and of 12/07/2012, C-311/11 P, *Wir machen das Besondere einfach*, EU:C:2012:460, § 23).

According to the case-law of the European courts, a word mark that is descriptive of characteristics of goods or services for the purposes of Article 7(1)(c) CTMR is, on that account, necessarily devoid of any distinctive character with regard to the same goods or services for the purposes of Article 7(1)(b) CTMR (judgment of 12/06/2007, T-190/05, *TWIST & POUR*, EU:T:2007:171, § 39).

In a similar vein, even though a given term might not be clearly descriptive with regard to the goods and services concerned, as to the point that an objection under Article 7(1)(c) CTMR would not apply, it would still be objectionable under Article 7(1)(b) CTMR on the ground that it will be perceived by the relevant public as only providing information on the nature of the goods and/or services concerned and not as indicating their origin. This was the case with the term 'medi', which was considered as merely providing information to the relevant public about the medical or therapeutic purpose of the goods or of their general reference to the medical field (judgment of 12/07/2012, T-470/09, *Medi*, EU:T:2012:369, § 22).

An objection under Article 7(1)(b) CTMR would also apply in those cases where the lexical structure employed, although not correct from a grammatical point of view, can be considered to be common in advertising language and in the commercial context at issue. This was the case of the combination 'ECO PRO', where the laudatory element PRO is placed after the descriptive element ECO and which would be perceived by the relevant public as an indication that the designated goods are intended for 'ecological professionals' or are 'ecological supporting' (judgment of 25/04/2013, T-145/12, *ECO PRO*, EU:T:2013:220, § 29-32).

2.2.2 Word elements

Words are non-distinctive or cannot convey distinctiveness to a composite sign if they are so frequently used that they have lost any capacity to distinguish goods and services. The following terms, alone or in combination with other unregistrable elements, fall foul of this provision.

Terms merely denoting a particular **positive or appealing quality or function** of the goods and services should be refused if applied for either alone or in combination with descriptive terms:

- **ECO** as denoting 'ecological' (judgments of 24/04/2012, T-328/11, *EcoPerfect*, EU:T:2012:197, § 25 and of 15/01/2013, T-625/11, *ecoDoor*, EU:T:2013:14, § 21);
- **MEDI** as referring to 'medical' (judgment of 12/07/2012, T-470/09, *medi*, EU:T:2012:369);

- **MULTI** as referring to ‘much, many, more than one’ (decisions of 21/07/1999, R 0099/1999-1, MULTI 2 ‘n 1; 17/11/2005, R 0904/2004-2, MULTI);
- **MINI** as denoting ‘very small’ or ‘tiny’ (decision of 17/12/1999, R 0062/1999-2, MINIRISC);
- **Premium/PREMIUM** as referring to ‘best quality’ (judgments of 22/05/2012, T-60/11, Patrizia Rocha, EU:T:2013:162, § 46-49, 56 and 58; and of 17/01/2013, joined cases T-582/11 and T-583/11, PREMIUM XL/ PREMIUM L, EU:T:2013:24, § 26);
- **PLUS**, as denoting ‘additional, extra, of superior quality, excellent of its kind’. (decision of 15/12/1999, R 0329/1999-1, PLATINUM PLUS);
- **ULTRA**¹ as denoting ‘extremely’ (decision of 09/12/2002, R 333/2002-1, ULTRAFLEX);
- **UNIVERSAL** as referring to goods that fit for general or universal use (judgment of 02/05/2012, T-435/11, UniversalPHOLED, EU:T:2012:210, § 22 and 28).

Top level domain endings, such as ‘.com’, only indicate the place where information can be reached on the internet and thus cannot render a descriptive or otherwise objectionable mark registrable. Therefore, www.books.com is as objectionable for printed matter as the term ‘books’ alone. This has been confirmed by the General Court in its judgment of 21/11/2012, T-338/11, photos.com, EU:T:2012:614, § 22, where it was stated that the element ‘.com’ is a technical and generic element, the use of which is required in the normal structure of the address of a commercial internet site. Furthermore, it may also indicate that the goods and services covered by the trade mark application can be obtained or viewed online, or are internet-related. Accordingly, the element in question must also be considered to be devoid of distinctive character in respect of the goods or services concerned.

Abbreviations of the **legal form of a company** such as Ltd., GmbH, etc. cannot add to the distinctiveness of a sign.

Names of individual persons are distinctive, irrespective of the frequency of the name and even in the case of the most common surnames (such as Jones or García, judgment of 16/09/2004, C-404/02, Nichols, EU:C:2004:538, § 26 and 30) or in the case of prominent persons (including heads of states). However, an objection will be raised if the name can **also** be perceived as a non-distinctive term in relation to the goods and services (e.g. ‘Baker’ for pastry products).

2.2.3 Titles of books

Trade marks consisting solely of a famous story or book title may be non-distinctive under Article 7(1)(b) CTMR in relation to goods and services that could have that story as their subject matter. The reason for this is that certain stories (or their titles) have

¹ Amended on 23/06/2010.

become so long established and well known that they have 'entered into the language' and are incapable of being ascribed any meaning other than that of a particular story.

For example, 'Peter Pan' or 'Cinderella' or 'The Iliad' are perfectly capable of being distinctive trade marks for paint, clothing or pencils, for instance. However, they are incapable of performing a distinctive role in relation to books or films, for example, because consumers will simply think that these goods refer to the story of Peter Pan or Cinderella, this being the only meaning of the terms concerned.

Objections should only be raised in such cases where the title in question is famous enough to be truly well known to the relevant consumer and where the mark can be perceived in the context of the goods/services as primarily signifying a famous story or book title. A finding of non-distinctiveness in this regard will be more likely where it can be shown that a large number of published versions of the story have appeared and/or where there have been numerous television, theatre and film adaptations reaching a wide audience.

Depending on the nature of the mark in question, an objection may be taken in relation to printed matter, films, recordings, plays and shows (this is not an exhaustive list).

2.2.4 Colours

This paragraph is concerned with single colours or combinations of colours as such ('colour per se').

Where colours or colour combinations as such are applied for, the appropriate examination standard is whether they are distinctive either if applied to the goods or their packaging, or if used in the context of delivery of services. It is a sufficient ground for a mark to be refused if the mark is not distinctive in either of these situations. For colour combinations, examination of distinctiveness should be based on the assumption that the colour combination in the way it is filed appears on the goods or their packaging, or in advertisements or promotional material for the services.

2.2.4.1 Single colours

As regards the registration as trade marks of colours *per se*, the fact that the number of colours actually available is limited means that a small number of trade mark registrations for certain services or goods could exhaust the entire range of colours available. Such an extensive monopoly would be incompatible with a system of undistorted competition, in particular because it could have the effect of creating an unjustified competitive advantage for a single trader. Nor would it be conducive to economic development or the fostering of the spirit of enterprise for established traders to be able to register the entire range of colours that is in fact available for their own benefit, to the detriment of new traders (judgment of 06/05/2003, C-104/01, Libertel, EU:C:2003:244).

As has been confirmed by the Court of Justice, consumers are not in the habit of making assumptions about the origin of goods based on their colour or the colour of their packaging, in the absence of any graphic or word element, because as a rule a colour *per se* is not used as a means of identification in current commercial practice (judgment of 06/05/2003, C-104/01, Libertel, EU:C:2003:244). A colour is not normally inherently capable of distinguishing the goods of a particular undertaking (para. 65).

Therefore, single colours are not distinctive for any goods and services except under very special circumstances.

Such very special circumstances require the applicant to demonstrate that the mark is absolutely unusual or striking in relation to these specific goods. These cases will be extremely rare, for example in the case of the colour black for milk. It is not necessary for a refusal that one of the factors listed in paragraph 2.2.4.2 below is present, but if this is the case, it should be used as a further argument in support of the refusal. Where the single colour is found to be commonly used in the relevant sector(s) and/or to serve a decorative or functional purpose, the colour must be refused. The public interest is, according to the Court, an obstacle to the monopolisation of a single colour irrespective of whether the relevant field of interest belongs to a very specific market segment (judgment of 13/09/2010, T-97/08, Orange II, EU:T:2010:396, § 44-47).

2.2.4.2 Colour combinations

Where a combination of colours per se is applied for, the graphic representation filed must spatially delineate these colours so as to determine the scope of the right applied for. The graphic representation should clearly indicate the proportion and position of the various colours, thus systematically arranging them by associating the colours in a predetermined and uniform way (judgments of 24/06/2004, C-49/02, Blau/Gelb, EU:C:2004:384, § 33 and of 14/06/2012, judgment of 06/05/2003, C-104/01, Libertel, EU:C:2003:244).

For example, a mark comprising a small yellow stripe on top of red is different from red and yellow presented in even proportions, with red on the left side. An abstract claim, in particular to two colours 'in any possible combination' or 'in any proportion', is not allowable and leads to an objection under Article 7(1)(a) CTMR (decision of 27/07/2004, R 0730/2001-4, 'GELB/BLAU/ROT', § 34). This must be distinguished from the indication of how the colour combination would appear on the product, which is not required because what matters in connection with the assessment of inherent distinctiveness is the subject matter of the registration, not the way it is or can be used on the product.

In the case of colour combination, a refusal can only be based on specific facts or arguments, and where such specific arguments to refuse are not established, the mark must be accepted. If one of the two colours is either the commonplace colour for the product or the natural colour of the product, that is to say, a colour is added to the usual or natural colour of the product, an objection applies in the same way as if there were only one colour. Example: grey is the usual colour for the grip of gardening tools, and white is the natural colour of washing tablets. Therefore, a washing tablet which is white with another layer in red is in fact to be judged as a case that involves the addition of a colour.

The situations in which a combination of two colours should nevertheless be refused include the following.

- In many instances, a colour would merely be a decorative element of the goods or comply with the consumer's request (e.g. colours of cars or T-shirts), irrespective of the number of colours concerned.
- A colour can be the nature of the goods (e.g. for tints).

- A colour can be technically functional (e.g. colour red for fire extinguishers, various colours used for electric cables).
- A colour may also be usual or generic (e.g. again, red for fire extinguishers, yellow for postal services).
- A colour may indicate a particular characteristic of the goods such as a taste (yellow for lemon taste, pink for strawberry taste).
- A colour combination should also be refused if the existence of the colour combination can already be found on the market, in particular if used by several different competitors (e.g. we were able to demonstrate that the colour combination red and yellow is used by various enterprises on beer or soft drink cans).

In all these cases the trade mark should be objected to but with careful analysis of the goods and services concerned and the situation on the market.

The criteria to assess the distinctiveness of colour marks designating services should not be different from those applicable to colour marks designating goods (as recalled by the General Court in its judgment of 12/11/2010, T-404/09, *Grau/Rot*, EU:T:2010:466). In this case, the colour combination applied for was considered not to differ for the relevant consumer in a perceptible manner from the colours usually used for the services concerned. The General Court concluded that the colour combination applied for was very close to the combination 'white/red' used on the railway crossing gates and traffic signs associated with train traffic and that the sign, as a whole, would be recognised by the relevant public as a functional or decorative element and not as an indication of the commercial origin of the services.

The higher the number is, the less distinctiveness is likely, because of the difficulty of memorising a high number of different colours and their sequence.

For the names of colours see paragraph 2.3.2.9 below.

2.2.5 Single letters²

2.2.5.1 General considerations

In its judgment of 09/09/2010, C-265/09 P (α), EU:C:2010:508, the Court of Justice ruled that, in the case of trade marks consisting of single letters represented in standard characters with no graphic modifications, it is necessary to assess whether the sign at issue is capable of distinguishing the different goods and services in the context of an examination, based on the facts, focusing on the goods or services concerned (para. 39).

The Court recalled that, according to Article 4 CTMR, letters are among the categories of signs of which a Community trade mark may consist, provided that they are capable

² This part deals with single letters under Article 7(1)(b) CTMR. For single letters under Article 7(1)(c) CTMR, see paragraph 2.3.2.8 below.

of distinguishing the goods or services of one undertaking from those of other undertakings (para. 28), and emphasised that registration of a sign as a trade mark does not require a specific level of linguistic or artistic creativity or imaginativeness on the part of the applicant.

Although acknowledging that it is legitimate to take into account the difficulties in establishing distinctiveness that may be associated with certain categories of trade marks because of their very nature, and that it may prove more difficult to establish distinctiveness for marks consisting of a single letter than for other word marks (para. 39), the Court clearly stated that these circumstances do not justify laying down specific criteria supplementing or derogating from application of the criterion of distinctiveness as interpreted in the case-law (paras 33-39).

As to the burden of proof, the Court stated that when examining absolute grounds for refusal, the Office is required under Article 76(1) CTMR to examine, of its own motion, the relevant facts that might lead it to raise an objection under Article 7(1) CTMR and that that requirement cannot be made relative or reversed to the detriment of the CTM applicant (paras 55-58). Therefore, it is for the Office to explain, with motivated reasoning, why a trade mark consisting of a single letter represented in standard characters is devoid of any distinctive character.

It is therefore necessary to carry out a thorough examination based on the specific factual circumstances of the case in order to assess if a given single letter represented in standard characters can function as a trade mark in respect of the goods/services concerned. This need for a factual assessment implies that it is not possible to rely on assumptions (such as that consumers are generally not accustomed to seeing single letters as trade marks).

Consequently, when examining single letter trade marks, generic, unsubstantiated arguments such as those relating to the availability of signs should be avoided, given the limited number of letters. The Office is obliged to establish, on the basis of a factual assessment, why the applied for trade mark would be objectionable.

It is therefore clear that the examination of single letter trade marks should be thorough and stringent, and that each case calls for careful examination of whether a given letter can be considered inherently distinctive for the goods and/or services concerned.

2.2.5.2 Examples

For instance, in technical domains such as those involving computers, machines, motors and tools, it is more likely that single letters will be perceived as technical, model or catalogue references rather than as indicators of origin, although the fact that this is the case should result from a factual assessment.

Depending on the outcome of the prior examination, a trade mark consisting of a single letter represented in standard characters might be objectionable under Article 7(1)(b) CTMR on the ground that it is devoid of inherent distinctiveness for the goods and/or services concerned or part thereof.

This would be the case, for example, for a trade mark consisting of the single letter 'C' for 'fruit juices', as this letter is commonly used to designate vitamin C. The relevant public would not perceive it as a sign distinguishing the commercial origin of the goods in question.

Other examples of lack of distinctiveness would be single-letter trade marks applied for in respect of toy cubes, which are often used to teach children how to construct words by combining letters appearing on the cubes themselves, without however describing the product as such, or single letters applied for in respect of lottery services, a sector in which letters are often used to indicate different series of numbers.

Although in both the above cases there is no direct descriptive relationship between the letters and the goods/services, a trade mark consisting of a single letter would lack distinctiveness, because when it comes to toy cubes and lotteries, consumers are more used to seeing single letters as having either a functional or a utilitarian connotation, rather than as indicators of commercial origin.

However, if it cannot be established that a given single letter is devoid of any distinctive character for the goods and/or services concerned, then it should be accepted, even if represented in standard characters or in a fairly basic manner.



For example, the letter  was accepted in respect of 'transport; packaging and storage of goods; travel arrangement' in Class 39 and 'services for providing food and drink; temporary accommodation' in Class 43 (decision of 30/09/2010, R 1008/2010-2, § 12-21).

For further examples see paragraph 2.3.2.8 below.

2.2.6 Slogans: assessing distinctive character

The Court of Justice has ruled that it is inappropriate to apply to slogans stricter criteria than those applicable to other types of signs when assessing their distinctive character (judgment of 12/07/12, C-311/11 P, WIR MACHEN DAS BESONDERE EINFACH, EU:C:2012:460 and case-law cited).

Advertising slogans are objectionable under Article 7(1)(b) CTMR when the relevant public perceives them as a mere promotional formula. However, they are deemed to be distinctive if, apart from their promotional function, the public perceives them as an indication of the commercial origin of the goods or services in question.

The Court of Justice has provided the following criteria that should be used when assessing the distinctive character of a slogan (judgments of 21/01/2010, C-398/08 P, VORSPRUNG DURCH TECHNIK, EU:C:2010:29, § 47, and of 13/04/2011, T-523/09, WIR MACHEN DAS BESONDERE EINFACH, EU:T:2011:175, § 37).

An advertising slogan is likely to be distinctive whenever it is seen as more than a mere advertising message extolling the qualities of the goods or services in question because it:

- has a number of meanings and/or
- constitutes a play on words and/or
- introduces elements of conceptual intrigue or surprise, so that it may be perceived as imaginative, surprising or unexpected, and/or
- has some particular originality or resonance and/or

- triggers in the minds of the relevant public a cognitive process or requires an interpretative effort.

In addition to the above, the following characteristics of a slogan may contribute towards a finding of distinctiveness:

- unusual syntactic structures
- the use of linguistic and stylistic devices such as alliteration, metaphors, rhyme, paradox, etc.

However, the use of unorthodox grammatical forms must be carefully assessed because advertising slogans are often written in a simplified form, in such a way as to make them more concise and snappier (inter alia, judgment of 24/01/2008, T-88/06, SAFETY 1ST, EU:T:2008:15, § 40). This means that a lack of grammatical elements such as definite articles or pronouns (THE, IT, etc.), conjunctions (OR, AND, etc.) or prepositions (OF, FOR, etc.) may not always be sufficient to make the slogan distinctive. In 'SAFETY 1ST', the Court considered that the use of '1ST' instead of 'FIRST' was not sufficiently unorthodox to add distinctiveness to the mark.

A slogan whose meaning is vague or impenetrable or whose interpretation requires considerable mental effort on the part of the relevant consumers is also likely to be distinctive since consumers would not be able to establish a clear and direct link with the goods and services claimed.

The fact that the relevant public is a specialist one and its degree of attention is higher than average cannot decisively influence the legal criteria used to assess the distinctive character of a sign. As stated by the Court of Justice, 'it does not necessarily follow that a weaker distinctive character of a sign is sufficient where the relevant public is specialist' (judgment of 12/07/12, C-311/11 P, WIR MACHEN DAS BESONDERE EINFACH, EU:C:2012:460, § 48).

Moreover, according to well-established case-law from the General Court, the level of attention of the relevant public may be **relatively low** when it comes to promotional indications, whether what is involved are average end consumers or a more attentive public made up of specialists or circumspect consumers. This finding is applicable even for goods and/or services where the level of attention of the relevant public is generally high, such as financial and monetary services (judgments of 29/01/2015, T-609/13 SO WHAT DO I DO WITH MY MONEY, EU:T:2015:54, § 27 and T-59/14 INVESTING FOR A NEW WORLD, EU:T:2015:56, § 27 and quoted case-law).

The following examples show some of the different functions that slogans may serve and the arguments that can support an objection under Article 7(1)(b) CTMR.

CTM	Main function	Case No
CTM No 5 904 438 MORE THAN JUST A CARD for Class 36 (bank, credit and debit card services)	Customer service statement	R 1608/2007-4
Objected to under Article 7(1)(b) CTMR The slogan merely conveys information about the goods and services applied for. It is the kind of language an English speaker would use to describe a bank card that is a little out of the ordinary. It conveys the notion that the card has welcome features that are not obvious at first sight. The fact that the slogan leaves open what these features are, that is to say that the mark does not describe a specific service or characteristic of the 'card', does not make the mark distinctive.		

CTM	Main function	Case No
CTM No 7 394 414 WE PUT YOU FIRST. AND KEEP YOU AHEAD for Class 40	Customer service statement	(Examiner's decision without BOA case)
<p>Objected to under Article 7(1)(b) CTMR</p> <p>The mark is a promotional laudatory message, highlighting the positive aspects of the services, namely that they help to procure the best position in the business and maintain this position in the future.</p>		
CTM	Main function	Case No
CTM No 6 173 249 SAVE OUR EARTH NOW for Classes 3, 17, 18, 20, 22, 24, 25 and 28	Value statement or political motto	R 1198/2008-4
<p>Objected to under Article 7(1)(b) CTMR</p> <p>The sign is a simple and straightforward appeal to take action and contribute to the earth's well-being by favouring the purchase of environment-friendly products. Contrary to the appellant's contentions that the word 'now' constitutes an original element since nobody will believe that by purchasing the goods in question they will literally save the Earth now, the word 'NOW' is an emotional word commonly used in marketing to urge consumers to consume, to get what they want without waiting; it is a call to action. The relevant consumer will immediately recognise and perceive the sign as a promotional laudatory expression indicating that the goods represent an environment-friendly alternative to other goods of the same sort, and not as an indication of commercial origin.</p>		
CTM	Main function	Case No
CTM No 4 885 323 DRINK WATER, NOT SUGAR for Classes 32 and 33	Inspirational or motivational statement	R 718/2007-2
<p>Objected to under Article 7(1)(b) CTMR</p> <p>The mark is a banal slogan that merely conveys the idea that the consumer will be drinking real water rather than a sugary drink. The mark lacks any secondary or covert meaning, has no fanciful elements, and its message to the consumer is plain, direct and unambiguous. For these reasons, it is unlikely to be perceived as a sign of trade origin. It is easily seen that the mark consists merely of good counsel, namely that it is better from a health point of view to drink water that has not been sugared. What better way to promote such goods than by an expression such as DRINK WATER, NOT SUGAR? Consumers will read this with approval, but will look elsewhere on the product for the trade mark.</p>		
CTM	Main function	Case No
DREAM IT, DO IT! Classes 35, 36, 41 and 45	Inspirational or motivational statement	T-186/07
<p>The relevant English-speaking public will see this as an invitation or encouragement to achieve their dreams and will understand the message that the services covered by that trade mark will allow them to do so.</p>		
CTM	Main function	Case No
VALORES DE FUTURO for Class 41	Value statement	Judgment of 06/12/2013, T-428/12
<p>Objected to under Article 7(1)(b) CTMR</p> <p>The relevant public when confronted with the expression VALORES DE FUTURO will perceive a laudatory message whose only objective is to give a positive view of the services involved.</p>		

Absolute Grounds for Refusal

CTM	Main function	Case No
INVESTING FOR A NEW WORLD Classes 35 and 36	Value statement	Judgment of 29/01/2015, T-59/14
<p>Objected to under Article 7(1)(b) CTMR</p> <p>The sign INVESTING FOR A NEW WORLD, considered as a whole, may be easily understood by the relevant public, in view of the common English words of which it consists, as meaning that the services offered are intended for a new world's needs. Given that the services covered by the mark applied for are all related to activities connected with finance and have a close link with the word 'investing', the Board of Appeal was right to find that the message conveyed by the expression 'investing for a new world' was that, when purchasing the services in question, the money or capital invested created an opportunity in a new world, which carried a positive connotation. The Court also found that the fact that the expression at issue could be interpreted in a number of ways did not alter its laudatory nature.</p>		
CTM	Main function	Case No
SO WHAT DO I DO WITH MY MONEY Classes 35 and 36	Value statement	Judgment of 29/01/2015, T-609/13
<p>Objected to under Article 7(1)(b) CTMR</p> <p>The expression 'so what do I do with my money' prompts consumers to ask themselves what they should do with their financial resources and assets. In the present case, the average reasonably well-informed and reasonably observant and circumspect consumer of the services covered by the application for registration will, on reading or hearing that expression, ask himself/herself whether he/she is using his/her money effectively.</p>		
CTM	Main function	Case No
PIONEERING FOR YOU Classes 7, 9, 11, 37 and 42	Value statement	Judgment of 12/12/2014, T-601/13
<p>Objected to under Article 7(1)(b) CTMR</p> <p>The sign would be understood as 'innovative for you'. The meaning of the sign is clear and does not leave any doubts. The structure of the sign is grammatically correct and does not trigger any mental process in order to arrive at its meaning. It is, as a whole, a simple message that could be attributed to any producer or service provider with the natural consequence that it does not indicate the origin of the goods or services</p>		

Some examples of accepted slogans:

CTM	Classes	Case No
SITEINSIGHTS	Classes 9 and 42	R 879/2011-2, CTM No 9 284 597
CTM	Classes	Case No
THE PHYSICIAN DRIVEN IMAGING SOLUTION	Classes 9, 16 and 42	IR No 01 096 100
CTM	Classes	Case No
WET DUST CAN'T FLY	Classes 3, 7 and 37	T-133/13
<p>The concept of 'wet dust' is literally inaccurate, since dust is no longer dust when it is wet. Consequently, the juxtaposition of those two words gives that concept a fanciful and distinctive character.</p>		





A slogan is objectionable under Article 7(1)(c) CTMR if it immediately conveys information about the kind, quality, intended purpose or other characteristics of the goods or services (see paragraph 2.3.2.5 below).

2.2.7 Simple figurative elements

Simple geometric devices such as circles, lines, rectangles or common pentagons are unable to convey any message that can be remembered by consumers and will accordingly not be seen by them as a trade mark.

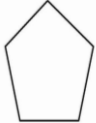
As set out by the Court, an extremely simple sign, composed of a basic geometric figure such as a circle, a line, a rectangle or a pentagon is not capable, as such, of conveying a message that consumers can remember, with the result that they will not consider it as a trade mark (T-304/05, § 22).

Examples of refused trade marks

Sign	G&S	Reasoning	Case
	Class 33	The sign consists merely of a normal pentagon, a simple geometric figure. The geometric form, if it happened to be the form of the label, would be perceived as having a functional or aesthetic purpose rather than an origin function.	Judgment of 12/09/2007, T-304/05, Pentagon, EU:T:2007:271
	Classes 9, 14, 16, 18, 21, 24, 25, 28, 35-39, 41-45	The sign will be perceived as an excessively simple geometric shape, essentially as a parallelogram. To fulfil the identification function of a trade mark, a parallelogram should contain elements which singularise it in relation to other parallelograms' representations. The two characteristics of the sign are the fact that it is slightly inclined towards the right and that the base is slightly rounded and stretched out towards the left. Such nuances would not be perceived by the general consumer.	Judgment of 13/04/2011, T-159/10, Parallelogram, EU:T:2011:176
	Classes 14, 18, 25	The sign does not contain any elements that may be easily and instantly memorised by an attentive relevant public. It will be perceived only as a decorative element, regardless of whether it relates to goods in Class 14 or to those in Classes 18 and 25.	Judgment of 29/09/2009, T-139/08, Smiley, EU:T:2009:364
	Class 9	The sign consists of a basic equilateral triangle. The inverted configuration and red outline of the triangle do not serve to endow the sign with distinctive character. The sign's overall impact remains that of a simple geometric shape that is not capable of transmitting a trade mark message prima facie.	International registration No 01 091 415
	Classes 3, 18, 24, 43, 44	The sign consists of merely a simple geometric figure in green. The specific colour is commonly and widely used in advertising and in the marketing of goods and services for the power to attract without giving any precise message.	Judgment of 09/12/2010, T-282/09, Carré convexe vert, EU:T:2010:508

Example of an accepted trade mark

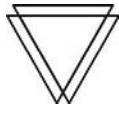
Sign	G&S	Reasoning	Case
	Classes 35, 41	The sign consists of a design featuring overlapping triangular elements. The overall impression created is far more complex than that of a simple geometric shape.	CTM No 10 948 222

2.2.8 Commonplace figurative elements

The following representation of a vine leaf is not distinctive for wine:



Similarly, the following representation of a cow for milk products is not distinctive:





CTM No 11 345 998, claiming Classes 29 (milk and milk products, etc.) and 35.

The above sign was refused, as representations of cows are commonly used in relation to milk and milk products. The fact that the subject mark consists of an 'aerial' picture of a cow is not sufficient to confer distinctive character to the sign, as slight alterations to a commonplace sign will not make that sign distinctive. The same reasoning would be applicable also to related goods such as 'milk chocolate'.

2.2.9 Typographical symbols

Typographical symbols such as a dot, comma, semicolon, quotation mark or exclamation mark will not be considered by the public as an indication of origin. Consumers will perceive them as a sign meant to catch the consumer's attention but not as a sign that indicates commercial origin. A similar reasoning applies to common currency symbols, such as the €, £, \$ signs; depending on the goods concerned, these signs will only inform consumers that a specific product or service is traded in that currency.



The following marks were objected to.

Sign	G&S	Reasoning	Case
	<p>Classes 14, 18 and 25</p>	<p>The GC confirmed the finding of the BoA that the trade mark applied for is devoid of the necessary degree of distinctive character. It consists merely of a punctuation mark with no special additional features immediately apparent to customers, and is a commonplace sign that is frequently used in business or in advertising. In view of its frequent use, the relevant consumer will see the exclamation mark as being merely laudatory advertising or something to catch the eye (see judgment of 30/09/2009, T-75/08, !, EU:T:2009:374).</p>	<p>CTM No 5 332 184</p>
	<p>Classes 29, 30, 31 and 32</p>	<p>The sign applied for was refused because, in the case of the claimed goods (foodstuff and beverages), percentages are particularly important in relation to the price. For example, the percentage sign indicates clearly that there is a favourable cost/benefit ratio because the price has been reduced by a particular percentage in comparison with the normal price. Such a per cent sign in a red circle is also frequently used in connection with clearance sales, special offers, stock clearances or cheap no-name products, etc. The consumer will regard the sign merely as a pictogram conveying the information that the goods claimed are sold at a reduced price (see decision of 16/10/2008, R 998/2008-1, 'Prozentzeichen').</p>	<p>CTM No 5 649 256</p>

2.2.10 Pictograms

Pictograms are basic and unornamented signs and symbols that will be interpreted as having purely informational or instructional value in relation to the goods or services concerned. Examples would be signs that indicate mode of use (like a picture of a telephone in relation to pizza delivery services) or that convey a universally understandable message (like a knife and fork in relation to the provision of food).

Commonly used pictograms, for example a white 'P' on a blue background to designate a parking place (this sign could also be objectionable under Article 7(1)(d)) or the design of an ice cream to designate that ice cream is sold in the vicinity, are not distinctive in relation to the goods or services in respect of which they are used.

Sign	Reasoning	Case
	<p>Taking into account the kind of goods and services applied for in Classes 9, 35, 36, 38 and 42 (for example cash dispensers, banking services), the public will see the sign as a practical indication or as directional arrows showing where the magnetic card has to be inserted into the distributor. The association of the triangles to the other elements of the trade mark applied for means that the public concerned will perceive them as directional arrows. Consumers see this type of practical information every day in all kinds of places, such as banks, supermarkets, stations, airports, car parks, telephone boxes, etc. (paras 37-42).</p>	<p>Judgment of 02/07/2009, T-414/07, Main tenant une carte, EU:T:2009:242</p>
 <p>CTM No 9 894 528 for goods in Class 9</p>	<p>The above sign was refused as it is identical to the core of the international safety symbol known as 'high voltage symbol' or 'caution, risk of electric shock'. It has been officially defined as such by ISO 3864 as the standard high voltage symbol, whereby the device applied for is contained within the triangle that denotes that it is a hazard symbol. Because this sign essentially coincides with the customary international sign to indicate a risk of high voltage, it was refused under Article 7(1)(b) CTMR.</p>	<p>Decision of 21/09/2012, R 2124/2011-5, 'Device of lightning bolt'</p>

2.2.11 Common/non-distinctive labels

A figurative sign may be composed of shapes, designs or figures that will be perceived by the relevant public as non-distinctive labels. Moreover, in this case the reason for the refusal lies in the fact that such figurative elements are not capable of impressing themselves in the consumer's mind, since they are too simple and/or commonly used in connection with the goods/services claimed.

See the following examples

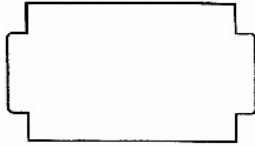
Sign	Reasoning	Case
 <p>CTM No 4 373 403, filed as a three-dimensional mark claiming goods in Class 16 (Adhesive labels; adhesive labels for use with hand labelling appliances; and labels (not of textile))</p>	<p>The mark applied for is 'devoid of any distinctive character' and was refused under Article 7(1)(b) CTMR as it is as banal and ordinary as it is possible to get in relation to adhesive labels. The sign says a lot about the nature of the goods and very little, if anything, about the identity of the producer (para. 11).</p>	<p>Decision of 22/05/2006, R 1146/2005-2</p>

Sign	Reasoning	Case
 <p data-bbox="236 517 539 600">CTM No 9 715 319 for goods in Classes 6, 7, 8, 9 and 20</p>	<p data-bbox="555 241 1093 763">The mark was refused, as its basic shape combined only with a bright colour yellow could not, in the minds of the relevant professional and general public, serve to distinguish the goods applied for as originating from a particular undertaking. Here, the colour yellow may be perceived as a decoration for the goods, as well as for the purpose of attracting attention to the goods without giving any specific information or precise message as to the commercial origin of the goods. In addition, as is generally known, the bright colour yellow is commonly used in a functional way in relation to a wide range of goods, i.e., inter alia, for increasing the visibility of objects, highlighting or warning. For these reasons, the relevant consumers will not recognise this colour as a trade mark, but will perceive it in its alerting function or its decorative function.</p>	<p data-bbox="1106 436 1355 573">Decision of 15/01/2013, R 0444/2012-2, Device of a label in yellow colour</p>

In the same way, the following marks were rejected.

 <p data-bbox="258 1144 576 1196">CTM No 11 177 912 claiming Classes 29, 30 and 31</p>	 <p data-bbox="639 1144 954 1196">CTM No 11 171 279 claiming Classes 29, 30 and 31</p>	 <p data-bbox="1015 1111 1342 1189">CTM No 10 776 599 claiming, inter alia, goods in Classes 32 and 33</p>
--	--	--

In the three preceding cases, both the colour and the shape of the labels are quite commonplace. The same reasoning applies to the stylised representation of the fruits in the last of the three cases. Furthermore, the said figurative element represents or at least strongly alludes to the ingredients of some of the claimed goods, such as, for example, fruit juices.

2.2.12 Three-dimensional trade marks

2.2.12.1 Preliminary remarks

Article 7(1)(b) CTMR does not distinguish between different categories of trade marks in determining whether a trade mark is capable of distinguishing the goods or services of one undertaking from those of other undertakings (see judgment of 05/03/2003, T-194/01, Soap device, EU:T:2003:53, § 44). In applying this uniform legal standard to different trade marks and categories of trade marks, a distinction must be made in accordance with consumer perception and market conditions.

For signs consisting of the shape of the goods themselves, no stricter criteria shall apply than for other marks, but it may be more difficult to come to a finding of distinctiveness, as such marks will not necessarily be perceived by the relevant public

in the same way as a word or figurative mark (see judgment of 08/04/2002, C-136/02 P, *Torches*, EU:C:2004:592, § 30).

Three-dimensional trade marks can be grouped into three categories:

- shapes unrelated to the goods and services themselves
- shapes that consist of the shape of the goods themselves or part of the goods
- the shape of packaging or containers.

2.2.12.2 Shapes unrelated to the goods or services themselves

Shapes that are unrelated to the goods or services themselves (e.g. the Michelin Man) are usually distinctive.

2.2.12.3 Shape of the goods themselves or shapes related to the goods or services.

The case-law developed for three-dimensional marks that consist of the representation of the shape of the product itself is also relevant for figurative marks consisting of two-dimensional representations of the product or elements of it (see judgment of 14/09/2009, T-152/07, *Uhr*, EU:T:2009:324).

For a shape that is the shape or the packaging of the goods applied for, the examination should be conducted in the three following steps.

Step 1: Article 7(1)(e) CTMR analysis

In principle, the examiner should first examine whether one of the grounds for refusal under Article 7(1)(e) CTMR applies, as those cannot be overcome through acquired distinctiveness. With regard to this first step, see paragraph 2.5 below.

Step 2: Identifying the elements of the three-dimensional trade mark

In the second step, the examiner should determine whether the representation of the three-dimensional trade mark contains **other elements** such as words or labels that might give the trade mark a distinctive character. As a general principle, any element that on its own is distinctive will lend the 3D trade mark distinctive character as long as it is perceivable in the normal use of the product. Typical examples are words or figurative elements or a combination of these that appear on the exterior of the shape and remain clearly visible, such as labels on bottles. Consequently, even the standard shape of a product can be registered as a 3D trade mark if a distinctive word mark or label appears on it.

Sign	Case
	<p>R 1354/2007-1</p>
<p>The clearly legible words 'BEN BRACKEN' on the base of the bottle suffice on their own to impart distinctive character to the trade mark as a whole (para. 19).</p>	

However, non-distinctive elements or descriptive elements combined with a standard shape will not endow distinctiveness upon that shape (judgment of 18/01/2013, T-137/12, Vibrator, EU:T:2013:26, § 34-36).

Sign	Case
	<p>T-323/11</p>

An image depicting certain stones is embossed on the central part of the bottle.

The Court confirmed the BoA decision when it considered that the applicant had failed to prove that European consumers have sufficient information and knowledge to recognise that the embossing on the central part of the bottle at issue depicts the twelve-angle stones used in Inca constructions. Without that proof, European consumers will merely perceive the embossing as such without being aware of its significance, from which it follows that they will simply perceive it as a mere decoration without any distinctive character, because it is not particularly original or striking and, therefore, it will not serve to differentiate the bottle in question from the other bottles widely used in the packaging of beers (para. 25 and following).

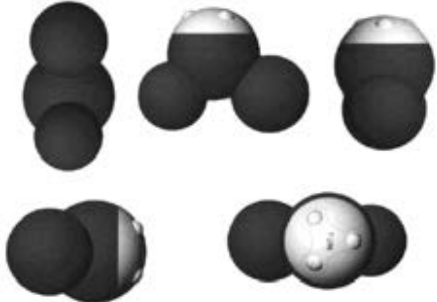
Sign	Case
	<p>T-137/12</p>

The Court considered that the descriptive element 'fun' could not confer distinctiveness on the 3D sign. Moreover, BoA was right not to take into account the element 'factory' written above the word 'fun' as it

Sign	Case
was illegible in the application (para. 34 and following).	
Sign	Case
	<p>R 1511/2013-2 (T-390/14 appeal pending)</p>
<p>BoA confirmed that the figurative element 'KANGOO JUMPS' (in both the upper spring layer and the lower spring layer) and the letters 'KJ' and 'XR' (at the ends of the intermediate elastic plastic straps) could only be seen with great difficulty or were not visible at all. Therefore, parts that can only be noticed by detailed analysis, like the present ones, will, in general, not be perceived as an indication of origin (para. 29).</p>	

Step 3: Criteria for distinctiveness of the shape itself

Lastly, the criteria for **distinctiveness of the shape itself** must be checked. The basic test is whether the shape is so materially different from basic, common or expected shapes that it enables a consumer to identify the goods just by their shape and to buy the same item again if he has had positive experiences with the goods. Frozen vegetables in the form of a crocodile are a good example for this.

The following criteria are relevant when examining the distinctiveness of three-dimensional trade marks consisting exclusively of the shape of the goods themselves:

- A shape is non-distinctive if it is a basic shape (judgment of 19/09/2001, T-30/00, TABS-SQUARE/RED/WHITE, EU:T:2001:223) or a combination of basic shapes (see BoA decision of 13/04/2000, R 0263/1999-3).
- To be distinctive, the shape must depart significantly from the shape which is expected by the consumer, and it must depart significantly from the norm or customs of the sector. The more closely the shape resembles the shape that is most likely to be taken by the product in question, the greater the likelihood that it is not distinctive (judgment of 08/04/2002, C-136/02 P, Torches, EU:C:2004:592, § 31).
- It is not enough for the shape to be just a variant of a common shape or a variant of a number of shapes in an area where there is a huge diversity of designs (judgments of 08/04/2002, C-136/02 P, Torches, EU:C:2004:592, § 32 and 07/02/2002, T-88/00, Torches, EU:T:2002:28, § 37).

- Functional shapes or features of a three-dimensional mark will be perceived by the consumer as such. For example, for washing tablets, bevelled edges avoid damage to the laundry, and layers of different colours represent the presence of different active ingredients.

While the public is accustomed to recognising a three-dimensional mark as an indicator of source, this is not necessarily the case where the three-dimensional sign is indistinguishable from the product itself. Consequently, an assessment of distinctive character cannot result in different outcomes for a three-dimensional mark consisting of the design of the product itself and for a figurative mark consisting of a faithful representation of the same product (judgment of 19/09/2001, T-30/00, TABS-SQUARE/RED/WHITE, EU:T:2001:223, § 49).

Specific case: 3D toys, dolls and play figures

Applications for 3D marks in respect of toys, dolls and play figures in Class 28, or for figurative marks consisting of a faithful representation of such goods, must be assessed in the **same way as other 3D marks**.

To be distinctive, the shape must depart significantly from the shape that is expected by the consumer. In other words, it must depart significantly from the norm or customs of the sector so that it enables a consumer to identify the goods just by their shape.





This may be complicated by the sheer volume and proliferation of toy animals, figures, dolls and assorted characters in this market sector. Simply adding a **basic** set of **clothing or basic human characteristics** such as eyes or a mouth to a common plush toy such as a rabbit or a cat will generally not suffice. It is commonplace to present toy dolls and animals in clothing and to provide separately a range of clothing options, so that the user of such goods can change the appearance of the toy. It is also common to humanise the toys to make them more attractive. Within such a high-volume marketplace, the presentation of these goods in such a way will invariably leave the relevant consumer struggling, without prior exposure, to perceive a badge of origin in such marks.

The more basic the character, the more unusual the additional elements must be in order to create a whole that serves to ensure that the relevant public is able to distinguish the applicant's goods from similar goods provided by other undertakings. The final conclusion must be based on the **appearance of the sign as a whole**.

Examples

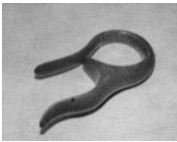
The following is a list of examples of shapes of goods applied for and an analysis of them.

Sign	Reasoning	Case
	<p>Figurative marks showing a graphic representation of a naturalistic reproduction of the goods themselves are not distinctive in relation to such goods. The representation of a tablet for 'washing or dishwashing preparations in tablet form' was refused. The shape, namely a rectangular tablet, is a basic shape and an obvious one for a product intended for use in washing machines or dishwashers. The slightly rounded corners of the tablet are not likely to be perceived by the consumer as a distinctive feature of the shape at issue (judgment of 19/09/2001, T-30/00, TABS-SQUARE/RED/WHITE, EU:T:2001:223, § 44 and 53). The same approach has been confirmed by several judgments, including the judgment of 04/10/2007, C-144/06 P, Tabs, EU:C:2001:577.</p>	<p>Judgment of 19/09/2001, T-30/00, TABS - SQUARE/RED/WHITE EU:T:2001:223</p>
	<p>This shape was refused as it is merely a variant of a common shape of this type of product, i.e. flashlights (para. 31).</p>	<p>Judgment of 08/04/2002, C-136/02 P, Torches, EU:C:2004:592</p>
	<p>This shape was refused because it does not depart significantly from the norm or customs of the sector. Even though the goods in this sector typically consist of long shapes, various other shapes exist in the market that are spherical or round (para. 29). The addition of the small descriptive word element 'fun factory' does not remove the overall shape from the scope of non-distinctiveness (para. 36).</p>	<p>Judgment of 18/01/2013, T-137/12, Vibrator, EU:T:2013:26.</p>
	<p>The Court of Justice confirmed the refusal of this three-dimensional sign as being not sufficiently different from the shapes and colours of those commonly used in the sweets and chocolate sectors. The combination with figurative elements will not lead to the application of the criteria for two-dimensional marks.</p>	<p>Judgment of 06/09/2012, C-96/11 P, Milchmäuse, EU:C:2012:537</p>

Sign	Reasoning	Case
	<p>This three-dimensional mark consisting of a handle, applied to goods in Class 8 (hand-operated implements used in agriculture, horticulture and forestry, including secateurs, pruning shears, hedge clippers, shearers (hand instruments)), was refused.</p>	<p>Judgment of 16/09/2009, T-391/07, Teil des Handgriffes, EU:T:2009:336</p>
	<p>The Court confirmed the case-law on non-distinctiveness of three-dimensional trade marks in the form of a product or its packaging. Even if the oval shape in the CTMA has a complex hollow on its surface, this cannot be considered as a significant difference to the shapes of confectionery available on the market.</p>	<p>Judgment of 12/12/2013, T-156/12 Oval, EU:T:2013:642</p>
	<p>The parrot figure applied for, on its own, does not depart from the usual form of parrot toys sufficiently to be seen as a trade mark. Its coat colour resembles the green colour quite common among parrots. Its head is bigger than normal and it is standing on its hind legs, but in the Board's opinion, the majority of consumers would perceive the parrot shape as an ordinary parrot-shaped toy design, a rather banal toy, but not as an indication of origin (para. 16).</p>	<p>R 2131/2013-5</p>
	<p>Accepted</p>	<p>CTM No 10 512 218</p>

Analogous criteria, *mutatis mutandis*, apply to shapes related to services, for example the device of a washing machine for laundry services.

2.2.12.4 Shape of the packaging

The same criteria apply for the shape of bottles or containers for the goods. The shape applied for must be materially different from a combination of basic or common elements and must be striking. Also in the area of containers, regard must be had to any functional character of a given element. As in the field of containers and bottles, the usage in trade might be different for different types of goods, it is recommended to make a search as to which shapes are on the market, by choosing a sufficiently broad category of the goods concerned (i.e. in order to assess the distinctiveness of a milk container, the search must be carried out in relation to containers for beverages in general; see, in that regard, the opinion of the Advocate General of 14/07/2005 in C-173/04, Standbeutel, EU:C:2006:20).

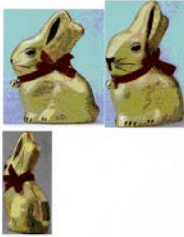
Sign	Reasoning	Case
	<p>The shape applied for was refused as it was considered that bunny-shaped chocolate with gold wrapping is a common phenomenon on the market corresponding to the concerned industry. An analysis of the individual elements, that is, the shape of a rabbit, the gold foil wrapping and the red ribbon with a bell, were held both individually and cumulatively devoid of distinctive character (paras 44-47).</p>	<p>Judgment of 24/05/2012, C-98/11 P, Hase, EU:C:2012:307</p>

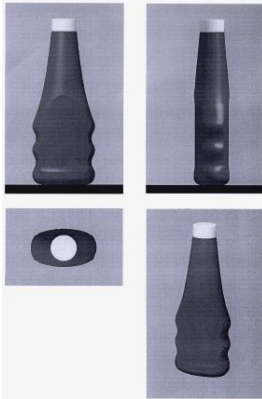
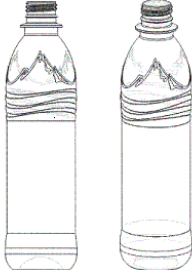
Sign	Reasoning	Case
	<p>The mark, the representation of a twisted wrapper serving as packaging for sweets (and thus not the product itself) was refused registration as it is a 'normal and traditional shape for a sweet wrapper and ... a large number of sweets so wrapped could be found on the market' (para. 56). The same applies in respect of the colour of the wrapper in question, namely 'light brown (caramel)'. This colour is not unusual in itself, and neither is it rare to see it used for sweet wrappers (para. 56). Therefore, the average consumer will not perceive this packaging in and of itself as an indicator of origin, but merely as a sweet wrapper.</p>	<p>Judgment of 10/11/2004, T-402/02, Bonbonverpackung, EU:T:2004:330</p>
	<p>The refusal of the shape applied for was confirmed by the General Court. The elongated neck and the flattened body do not depart from the usual shape of a bottle containing the claimed goods, namely food products including <i>juices, condiments and dairy products</i>. In addition, neither the length of the neck, its diameter nor the proportion between the width and thickness of the bottle is in any way individual (para. 50). Furthermore, even if the ridges around the sides of the bottle could be considered distinctive, these alone are insufficient to influence the overall impression given by the shape applied for to such an extent that it departs significantly from the norm or customs of the sector (para. 53).</p>	<p>Judgment of 15/03/2006, T-129/04, Plastikflaschenform, EU:T:2006:84</p>
	<p>It is a well-known fact that bottles usually contain lines and creases on them. The relief at the top is not sufficiently striking but will be perceived as a mere decorative element. As a whole, a combination of the elements is not sufficiently distinctive. The average consumer of the goods in Class 32 would not consider the shape as an indicator of origin of goods in Class 32.</p>	<p>Judgment of 19/04/2013, T- 347/10, Getränkeflasche, EU:T:2013:201 'Shape of a drinking bottle'</p>

2.2.13 Pattern marks

A figurative trade mark can be considered as a 'pattern' mark when it consists of a set of elements that are repeated regularly.

Pattern marks may cover any kind of goods and services. However, in practice they are more commonly filed in relation with goods such as paper, fabrics, clothing articles, leather goods, jewellery, wallpaper, furniture, tiles, tyres, building products, etc., that is to say, goods that normally feature designs. In these cases, the pattern is nothing else than the outward appearance of the goods. In this regard it must be noted that, although patterns may be represented in the form of square/rectangular labels, they should nonetheless be assessed as if they covered the entire surface of the goods applied for.

It must also be taken into account that when a pattern mark claims goods such as beverages or fluid substances in general, that is to say goods that are normally distributed and sold in containers, the assessment of the design should be made as if it covered the outward surface of the container/packaging itself.

It follows from the above that, as a rule, in the assessment of the distinctive character of patterns the examiner should use the same criteria that are applicable to three-dimensional marks that consist of the appearance of the product itself (see judgment of 19/09/2012, T-329/10, *Stoffmuster*, EU:T:2012:436).

With regard to services, examiners should bear in mind that pattern marks will be used in practice on letterheads and correspondence, invoices, internet web sites, advertisements, shop signs, etc.





In principle, if a pattern is commonplace, traditional and/or typical, it is devoid of distinctive character. In addition, patterns that consist of basic/simple designs usually lack distinctiveness. The reason for the refusal lies in the fact that such patterns do not convey any 'message' that could make the sign easily memorable for consumers. Paradoxically, the same applies to patterns composed of extraordinarily complex designs. In these cases the complexity of the overall design will not allow the design's individual details to be committed to memory (judgment of 09/10/2002, T-36/01, *Glass pattern*, EU:T:2002:245, § 28). Indeed, in many cases the targeted public would perceive patterns as merely decorative elements.

In this regard, it must be taken into account that usually the average consumer tends not to look at things analytically. A trade mark must therefore enable average consumers of the goods/services in question, who are reasonably well informed and reasonably observant and circumspect, to distinguish the product concerned from those of other undertakings without conducting an analytical or comparative examination and without paying particular attention (judgments of 12/02/2004, C-218/01, *Perwoll*, EU:C:2004:88, § 53, and of 12/01/2006, C-173/04, *Standbeutel*, EU:C:2006:20, § 29).

The fact that the pattern may also have other functions and/or effects is an additional argument to conclude that it lacks distinctive character. By contrast, if a pattern is fanciful, unusual and/or arbitrary, departs from the norm or customs of the sector or is, more generally, capable of being easily memorised by the targeted consumers, it usually deserves protection as a CTM.

As seen above, the distinctive character of pattern marks must usually be assessed with regard to goods. Nevertheless, a pattern mark that has been considered devoid of distinctive character for the goods it covers must also be regarded as lacking distinctiveness for services that are closely connected to those goods. For example, a stitching pattern that is devoid of distinctive character for clothing articles and leather goods must be regarded as lacking distinctiveness also for retail services concerning those goods (see by analogy decision of 29/07/2010, R 868/2009-4, *Device of a pocket*). The same considerations would apply to a fabric pattern with regard to services such as *manufacture of fabrics*.

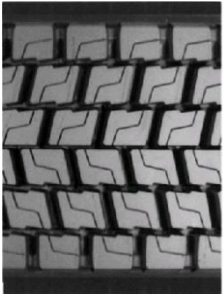
The following is a non-exhaustive list of examples of pattern marks.

Sign	Reasoning	Case
 <p data-bbox="236 622 539 703">CTM No 8 423 841, filed as a figurative mark in Classes 18, 24 and 25</p>	<p data-bbox="555 331 1093 685">The criteria for three-dimensional marks consisting of the appearance of the product itself are also applicable to figurative marks consisting of the appearance of the product itself. In general, a mark consisting of a decorative pattern that is simple and commonplace is considered devoid of any element that could attract the consumers' attention, and insufficient to indicate the source or origin of goods or services. The above pattern mark was a textile pattern and therefore considered to comprise the appearance of the products itself, as the mark was applied for in Classes 18, 24 and 25.</p>	<p data-bbox="1118 443 1353 573">Judgment of 19/09/2012, T-326/10, Stoffmuster, EU:T:2012:436, § 47 and 48</p>
 <p data-bbox="236 1037 539 1120">CTM No 8 423 501, filed as a figurative mark in Classes 18, 24 and 25</p>	<p data-bbox="555 896 1093 949">In this case, similarly to the previous case, the General Court confirmed the refusal of the mark.</p>	<p data-bbox="1118 869 1353 976">Judgment of 19/09/2012, T-329/10, Stoffmuster, EU:T:2012:436</p>
 <p data-bbox="236 1462 539 1545">CTM No 5 066 535 filed as a figurative mark in Class 12 (tyres)</p>	<p data-bbox="555 1205 1093 1482">Where the mark consists of a stylised representation of the goods or services, the relevant consumer will see <i>prima facie</i> the mere representation of a specific part of or the entire product. In this case of an application for <i>tyres</i>, the relevant consumer would perceive the mark as merely a representation of the grooves of a tyre, and not an indication of source or origin. The pattern is banal and the mark cannot fulfil its function as indicator of origin.</p>	<p data-bbox="1118 1317 1353 1370">Examiner's decision without BOA case</p>
 <p data-bbox="236 1854 539 1966">CTM No 9 526 261, filed as a figurative mark (Series of stylised V letters), claiming goods in Classes 16, 18, 25</p>	<p data-bbox="555 1657 1093 1904">The mark was rejected for Classes 18 and 25. It was accepted for Class 16. Though the sign was described as a 'series of stylised V letters', the sign would most probably be perceived by the relevant public either as a series of zigzag stitching or as a set of rhomboidal geometric figures. In any case, the pattern is quite simple and banal and thus devoid of any distinctive character.</p>	<p data-bbox="1118 1758 1353 1812">Examiner's decision without BOA case</p>

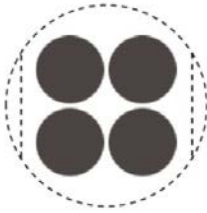
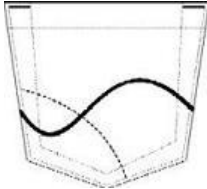
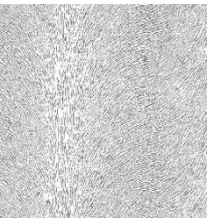
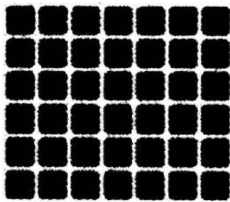
Sign	Reasoning	Case
 <p>CTM No 9 589 219, filed as a figurative mark for goods in Class 9</p>	<p>The sign, applied for in respect of 'multi-well plates that can be used in chemical or biological analysis using electrochemiluminescence for scientific, laboratory or medical research use', was refused as it does not serve the purpose of indicating origin. The application described the mark as corresponding to a pattern contained on the bottom of the goods, and the examiner was found to be correct in stating that due to the lack of any eye-catching features, the consumer would be unable to perceive it as anything other than a mere decoration of the goods.</p>	<p>Decision of 09/10/2012, R 412/2012-2, Device of four identically sized circles</p>
 <p>CTM No 6 900 898, for goods in Classes 18 and 25</p>	<p>The above mark was refused, as patterns stitched on pockets are commonplace in the fashion sector, and this particular pattern does not contain any memorable or eye-catching features likely to confer a minimum degree of distinctive character such as to enable a consumer to perceive it as anything other than a mere decorative element.</p>	<p>Judgment of 28/09/2010, T-388/09, DESIGN OF TWO CURVES CROSSED AT ONE POINT INSERTED ON A POCKET (FIG. MARK) EU:T:2010:410, § 19-27</p>
 <p>CTM No 3 183 068, filed as a figurative mark, for goods in Classes 19 and 21</p>	<p>The mark, which was to be applied to glass surfaces, was refused under Article 7(1)(b) CTMR. It was reasoned that the relevant consumer is not used to perceiving designs applied to glass surfaces as an indication of origin and that the design is recognisable as a functional component to make the glass opaque. Furthermore, the complexity and fancifulness of the pattern are insufficient to establish distinctiveness, attributable to the ornamental and decorative nature of the design's finish, and do not allow the design's individual details to be committed to memory or to be apprehended without the product's inherent qualities being perceived simultaneously.</p>	<p>Judgment of 09/10/2002, T-36/01, Glass pattern, EU:T:2002:245, § 26-28</p>
 <p>CTM No 10 144 848, filed as a figurative mark for goods in Classes 3, 5, 6, 10, 11, 12, 16, 18, 20 and 21</p>	<p>The mark was refused as it is composed of very simple elements and is a basic and banal sign as a whole. For the claimed goods, such as <i>cleaning cloths</i> and <i>antiseptic wipes</i>, the sign applied for can represent their appearance in the sense that the fabric used may have this structure. The sign is merely a repetition of identical squares that does not display any element or noticeable variation, in particular in terms of fancifulness or as regards the way in which its components are combined, that would distinguish it from the usual representation of another regular pattern consisting of a different number of squares. Neither the shape of each individual square nor the way they are combined are immediately noticeable features that could catch the average consumer's attention and cause the consumer to perceive the sign as a distinctive one.</p>	<p>Decision of 14/11/2012, R 2600/2011-1, Device of a black and white pattern</p>

 <p>CTM No 370 445 Class 18</p>	<p>The chequerboard pattern is a basic and commonplace figurative pattern, since it is composed of a regular succession of squares of the same size that are differentiated by alternating different colours, in this case brown and beige. The pattern thus does not contain any notable variation from the conventional representation of chequerboards and is the same as the traditional form of such a pattern. Even applied to goods such as those falling within Class 18, the pattern in question does not differ from the norm or customs of the sector inasmuch as such goods are generally covered with fabrics of different kinds, and the chequerboard pattern, due to its great simplicity, might constitute precisely one of those patterns (para. 37).</p>	<p>T-359/12, Device of a chequered pattern (maroon & beige), EU:T:2015:215 and T-360/12, Coty Germany, EU:C:2014:1318</p>
--	--	---

2.2.14 Position marks

Applications for position marks effectively seek to protect a sign that consists of elements (figurative, colour, etc.) positioned on a particular part of a product and in a particular proportion to the size of the product. The representation of the mark applied for must be accompanied by a description indicating the exact nature of the right concerned.

The factors to be taken into account when examining three-dimensional marks are also relevant for position marks. In particular, the examiner must consider whether the relevant consumer will be able to identify a sign that is different from the normal appearance of the products themselves. A further relevant consideration in dealing with position marks is whether the positioning of the mark upon the goods is likely to be understood as having a trade mark context.

Note that even where it is accepted that the relevant public may be attentive to the different aesthetic details of a product, this does not automatically imply that they will perceive it as a trade mark. In certain contexts, and given the norms and customs of particular trades, a position mark may appeal to the eye as an independent feature being distinguishable from the product itself and thus communicating a trade mark message.

The following are examples of the assessment of position marks.

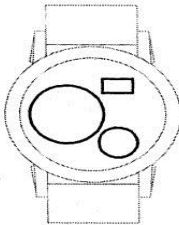
Sign	Reasoning	Case
	<p>In this case, the General Court upheld an objection under Article 7(1)(b) CTMR. The mark description specified that 'The mark consists of the position of the circular and rectangular fields on a watch face'. The Court considered that the mark was not independent or distinguishable from the form or design of the product itself and that the positioned elements were considered not substantially different from other designs on the market.</p>	<p>Judgment of 14/09/2009, T-152/07, Uhr, EU:T:2009:324</p>

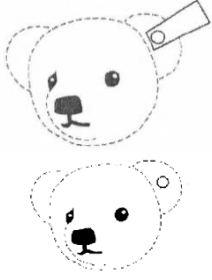
Sign	Reasoning	Case
	<p>In this case involving hosiery consisting of an orange strip covering the toe area, the General Court considered that there was no evidence to suggest that the colouring of this part of the product would normally be perceived as having trade mark character. On the contrary it was considered that this feature would be likely to be perceived as a decorative feature falling within the norms and customs of the market sector. The Article 7(1)b CTMR objection was therefore maintained.</p>	<p>Judgment of 15/06/2010, T-547/08, Strumpf, EU:T:2010:235</p>
	<p>Buttons are common decorative elements of soft toys. A button is a simple geometrical form which does not depart from the norm or customs of the sector. It is not uncommon to attach badges, rings, ribbons, loops and embroideries to the ears of a soft toy. The relevant public will therefore perceive the two signs applied for as ornamental elements but not as an indication of commercial origin.</p>	<p>Judgments of 16/01/2014 T-433/12, Knopff im Stofftierohr, EU:T:2014:8 and T-434/12, Fähnchen im Stofftierohr, EU:T:2014:6</p>

2.2.15 Sound marks

The acceptability of a sound mark must, like words or other types of trade marks, depend upon whether the sound is distinctive per se, that is, whether the average consumer will perceive the sound as a memorable one that serves to indicate that the goods or services are exclusively associated with one undertaking.

Consumers are not in the habit of making assumptions about the origin of goods in the absence of any graphic or word element, because generally a sound per se is not commonly used in any field of commercial practice as a means of identification.







The perception of the relevant public is not necessarily the same in the case of a sign consisting of a sound per se as it is in the case of a word or figurative mark consisting of a sign that bears no relation to the appearance of the goods it denotes. While the public is accustomed to perceiving word or figurative marks instantly as signs identifying the commercial origin of the goods, the same is not necessarily true where the sign is merely a sound (by analogy, judgment of 04/10/2007, C-144/06 P, Tabs, § 36). By the same token, **only a sound that departs significantly from the norm or customs of the sector and thereby fulfils its essential function of indicating origin** is not devoid of any distinctive character for the purposes of Article 7(1)(b) CTMR (by analogy, judgment of 24/05/2012, C-98/11 P, Hase, EU:C:2012:307, § 42).

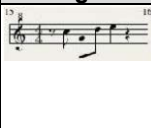

The kinds of sound marks that are **unlikely** to be accepted without evidence of factual distinctiveness include:

- a) very simple pieces of music consisting of only one or two notes (see examples below);
- b) sounds that are in the common domain (e.g. La Marseillaise, Für Elise);
- c) sounds that are too long to be considered as an indication of origin;
- d) sounds typically linked to specific goods and services (see examples below).

Where the sign applied for consists of a non-distinctive sound but includes **other distinctive elements**, such as words or lyrics, it will be considered as a whole.

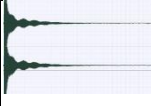
Examples

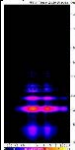
Sign	Description	G&S	Result	Reasoning	Case
	sequence of four different tones initially falling by a fourth and then rising and ending on the mediant	16, 35, 42	Distinctive	jingle-like sound sequences, are capable of identifying goods and services.	R 2056/2013-4
	The first two shorter A notes sound less powerful than the following long and higher C note. The higher and longer C note is thus accentuated on account of its pitch, length and strength.	9, 16, 35, 36, 41, 42	Distinctive	According to general life experience, jingle-like sound sequences, enable distinction between goods and services.	R 0087/2014-5
	Piece of music, three seconds long, combining different tones	9, 14, 16, 21, 25, 28, 35, 38, 41, 43	Distinctive		CTM 11 074 705
	Computer-generated sound of ten seconds	9, 28, 41	Distinctive		CTM 11 654 209
	Computer-generated sound of nearly 30 seconds including the sounds of animals followed by the sound of a motor	9, 12	Distinctive		CTM 10 654 374
	Two musical notes, F and C	35, 36, 38, 39, 41, 42	Not distinctive	A two note 'tune' has no impact on the consumer and will only be perceived by the consumer as a very banal sound, such as the 'ding-dong' of a doorbell.	CTMA 4 010 336
	Two extremely short blips	9, 38	Not distinctive	Machine generated blip that is commonly emitted by computers and other electronic devices	CTMA 9 199 167
	'Ping' sound, resembling a warning signal	9, 16, 28	Not distinctive	Sound constitutes a warning signal and a direct characteristic of the goods applied for	R 2444/2013-1

	Machine-generated synthesised sound	9, 12, 35	Not distinctive	Sound typically linked to the goods and services applied for	R 1338/2014-4
	The first 13 notes of 'La Marseillaise'	Any	Not distinctive	A national anthem is in the public domain	Invented example

2.3 Descriptiveness (Article 7(1)(c) CTMR)

2.3.1 General remarks

2.3.1.1 The notion of descriptiveness

A sign must be refused as descriptive if it has a meaning which is immediately perceived by the relevant public as providing information about the goods and services applied for. This is the case where the sign provides information about, among other things, the quantity, quality, characteristics, purpose, kind and/or size of the goods or services. The relationship between the term and the goods and services must be sufficiently direct and specific (judgments of 20/07/2004, T-311/02, *Limo*, EU:T:2004:245, § 30; 30/11/2004, T-173/03, *Nurseryroom*, EU:T:2004:347, § 20), as well as concrete, direct and understood without further reflection (judgment of 26/10/2000, T-345/99, *Trustedlink*, EU:T:2000:246, § 35). If a mark is descriptive, it is also non-distinctive.

Article 7(1)(c) CTMR does not apply to those terms that are only suggestive or allusive as regards certain characteristics of the goods and/or services. Sometimes this is also referred to as vague or indirect references to the goods and/or services (judgment 31/01/2001, T-135/99, *Cine Action*, EU:T:2001:30, § 29).

The public interest underlying Article 7(1)(c) CTMR is that exclusive rights should not exist for purely descriptive terms that other traders might wish to use as well. However, it is not necessary for the Office to show that there is already a descriptive use by the applicant or its competitors. Consequently, the number of competitors that could be affected is totally irrelevant. Therefore, if a word is descriptive in its ordinary and plain meaning, this ground for refusal cannot be overcome by showing that the applicant is the only person who produces, or is capable of producing, the goods in question.

2.3.1.2 The reference base

The **reference base** is the ordinary understanding of the relevant public of the word in question. That can be corroborated by **dictionary entries**, examples of the use of the term in a descriptive manner found on internet **websites**, or it may clearly follow from the **ordinary understanding** of the term.

It is not necessary for the Office to prove that the word is the subject of a dictionary entry in order to refuse a sign. In particular for composite terms, dictionaries do not mention all possible combinations. What matters is the ordinary and plain meaning. In addition, terms used as specialised terminology to designate the respective relevant characteristics of the goods and services are to be considered descriptive. In these cases it is not required to demonstrate that the meaning of the term is immediately apparent to the relevant consumers to which the goods and services are addressed. It

suffices that the term is meant to be used, or could be understood by part of the relevant public, as a description of the claimed goods or services, or a characteristic of the goods and services (judgment of 17/09/2008, T-226/07, Pranahaus, EU:T:2008:381, § 36).

The following principles in respect of both language and dictionary use apply, with regards to the reference base.

The sign must be refused if it is descriptive in any of the official languages of the European Union, regardless of the size or population of the respective country. Systematic language checks are only performed in the official languages of the European Union.

- Should there be convincing evidence that a given term has a meaning in a language other than the official languages of the Union and is understood by a significant section of the relevant public in at least a part of the European Union, this term must also be refused pursuant to Article 7(2) CTMR (judgment of 13/09/2012, T-72/11, Espetec, EU:T:2012:424, § 35-36). For example, the term HELLIM is the Turkish translation of the word 'Halloumi', a type of cheese. Since Turkish is an official language in Cyprus, it is a language that is understood and spoken by part of the population of Cyprus, and therefore the average consumer in Cyprus may understand that HELLIM is a descriptive term for cheese (judgment of 13/06/2012, T-534/10, Hellim, EU:T:2012:292).

The evidence can come by individual knowledge of the particular examiner, or is produced via third-party observations or by way of documentation included in cancellation requests.

- An internet search is also a valid means of evidence for the descriptive meaning, in particular for new terms, technical jargon or slang words, but the evidence should be carefully assessed in order to find out whether the word is actually used in a descriptive manner, as often the difference between descriptive and trade mark use on the internet is vague and the internet contains a vast amount of unstructured, unverified information or statements.
- The objection should clearly state which language or languages are concerned, which makes the ground for refusal applicable at least for the Member State in which this language is the official language or one of the official languages, and excludes conversion for that Member State (see Rule 45(4) CTMIR).

Article 7(1)(c) CTMR also applies to transliterations. In particular, transliterations into Latin characters of Greek words must be treated in the same way for the purpose of examining absolute grounds for refusal as words written in Greek characters and vice versa (judgment of 16/12/2010, T-281/09, Chroma, EU:T:2010:537, § 34). This is because the Latin alphabet is known to Greek-speaking consumers. The same applies to the Cyrillic alphabet, which is used in the EU by Bulgarians, who are also familiar with Latin characters.

2.3.1.3 Characteristics mentioned under Article 7(1)(c) CTMR

Kind of goods and services

This includes the goods or services themselves, that is, their type or nature. For example, 'bank' for financial services, 'Perl  ' for wines and sparkling wines (judgment of 01/02/2013, T-104/11, 'Perle') or 'Universaltelefonbuch' for a universal telephone directory (judgment of 14/06/2001, T-357/99 and T-358/99, Universaltelefonbuch, EU:T:2001:162) or constituent parts or components of the goods (judgment of 15/01/2013, T-625/11, EcoDoor, EU:T:2013:14, § 26).

Quality

This includes both laudatory terms, referring to a superior quality of the respective goods or services, as well as the inherent quality of the goods or services. It covers terms such as 'light', 'extra', 'fresh', 'hyper light' for goods that can be extremely light (decision of 27/06/2001, R 1215/00-3, Hyperlite). In addition, figures may refer to the quality of a product or a service, such as 24/7 for service availability; '2000', which refers to the size of the motor or '75', which refers to the horse power (kW) of the motor.

Quantity

This covers indications of the quantity in which the goods are usually sold, such as 'six pack' for beer, 'one litre' for drinks, '100' (grams) for chocolate bars, Only quantity measurements relevant in trade, not those that are hypothetically possible, count. For example, 99.999 for bananas would be acceptable.

Intended purpose

The intended purpose is the function of a product or service, the result that is expected from its use or, more generally, the use for which the good or service is intended. An example is 'Trustedlink' for goods and services in the IT-sector aimed at securing a safe (trusted) link (judgment of 26/10/2000, T-345/99, Trustedlink, EU:T:2000:246). Marks that have been refused registration on this basis include 'Therapy' for massage tools (decision of 08/09/1999, R 0144/99-3, THERAPY) and 'SLIM BELLY' for fitness training apparatus, sport activities, medical and beauty care services (judgment of 30/04/2013, T-61/12, Slim belly, EU:T:2013:226). This objection also applies as regards accessories: a term that described the type of goods also describes the intended purpose for accessories to those goods. Therefore, 'New Born Baby' is objectionable for accessories for dolls and 'Rockbass' for accessories for rock guitars (judgment of 08/06/2005, T-315/03, Rockbass, EU:T:2005:211 (appeal C-301/05 P settled)).

Value

This covers both the (high or low) price to be paid, as well as the value in quality. It covers therefore not only expressions such as 'extra' or 'top', but also expressions such as 'cheap' or 'more for your money'. It also covers expressions indicating, in common parlance, goods or services that are superior in quality.

Geographical origin

See paragraph 2.3.2.6 below.

Time of production of the goods or of rendering of the service

This covers expressions concerning the time at which services are rendered, either expressly ('evening news', '24 hours') or in a usual manner (24/7). It also covers the time at which goods are produced if that is relevant for the goods (late vintage for wine). For wine, the numeral '1998' indicating the vintage year would be relevant, but not for chocolate.

Other characteristics

This covers other characteristics of the goods or services and shows that the preceding list of items in Article 7(1)(c) is not exhaustive. In principle, any characteristic of the goods and services must lead to a refusal under Article 7(1)(c) CTMR. It does not matter whether the characteristics of the goods or services are commercially essential or merely ancillary or whether there are synonyms of those characteristics (judgments of 12/02/2004, C-363/99, Postkantoor, EU:C:2004:86, § 102; 24/04/2012, T-328/11, EcoPerfect, EU:T:2012:197, § 41).

Examples of 'other characteristics'

- the subject matter contained within the claimed goods or services: (see paragraph 2.3.2.7 below)
- the identification of the targeted consumer: 'children' or 'ellos' (judgment of 27/02/2002, T-219/00, Ellos, EU:T:2002:44) for *clothing*.

2.3.2 Word marks

2.3.2.1 One word

Descriptive terms are those that merely consist of information about the characteristics of the goods and services. This means that descriptive terms cannot fulfil the function of a trade mark. Consequently, the ground for refusal applies irrespective of whether a term is already used by other competitors in a descriptive manner for the goods and services at issue.

In particular, a word is descriptive if either for the general public (if the goods or services target them) or for a specialised public (irrespective of whether the goods or services also target the general public) the trade mark has a descriptive meaning:

- The term 'RESTORE', is descriptive for surgical and medical instruments and apparatus; stents; catheters; and guide wires (judgment of 17/01/2013, C-21/12 P, Restore, EU:C:2013:23)

- 'CONTINENTAL' is descriptive for 'live animals, i.e., dogs' and 'the keeping and breeding of dogs, i.e. puppies and animals for breeding'. Indeed, the word 'Continental' indicates a breed of bulldogs (judgment of 17/04/2013, T-383/10, Continental, EU:T:2013:193).

Furthermore, as seen above, objections should also be raised against terms that describe desirable characteristics of the goods and services.

However, it is important to distinguish laudatory terms that describe — although in general terms — desirable characteristics of goods and services as being cheap, convenient, of high quality, etc. and which are excluded from registration, from those terms that are laudatory in a broader sense, that is to say, they refer to vague positive connotations or to the person of the purchaser or producer of the goods without specifically referring to the goods and services themselves.

Not descriptive:

- 'BRAVO', as it is unclear who says 'BRAVO' to whom, and what is being praised (judgment of 04/10/2001, C-517/99, Bravo, EU:C:2001:510).

2.3.2.2 Combinations of words

As a general rule, a mere combination of elements, each of which is descriptive of characteristics of the goods or services themselves, remains descriptive of those characteristics. Merely bringing those elements together without introducing unusual variations, in particular as to syntax or meaning, cannot result in anything other than a descriptive sign.

However, if due to the unusual nature of the combination in relation to the goods or services a combination creates an impression **that** is sufficiently far removed from that produced by the mere combination of meanings lent by the elements of which it is composed, that combination will be considered more than the sum of its parts (judgment of 12/02/2004, C-265/00, Biomild, EU:C:2004:87, § 39 and 43). These notions, 'unusual nature of the combination', 'impression sufficiently far removed' and 'more than the sum of its parts' have to be interpreted as meaning that Article 7(1)(c) CTMR does not apply when the way in which the two descriptive elements are combined is in itself fanciful.

The following examples have been refused registration:

'Biomild' for yoghurt being mild and organic (judgment of 12/02/2004, C-265/00, Biomild, EU:C:2004:87);

'Companyline' for insurance and financial affairs (judgment of 19/09/2002, C-104/00 P, Companyline, EU:C:2002:506);

'Trustedlink' for software for e-commerce, business consulting services, software integration services and education services for e-commerce technologies and services (judgment of 26/10/2000, T-345/99, Trustedlink, EU:T:2000:246);

'Cine Comedy' for the broadcast of radio and television programmes, production, showing and rental of films, and allocation, transfer, rental and other exploitation

of rights to films (judgment of 31/01/2001, T-136/99, Cine Comedy, EU:T:2001:31);

‘Teleaid’ for electronic devices for transferring speech and data, repair services for automobiles and vehicle repair, operation of a communications network, towing and rescue services and computing services for determining vehicle location (judgment of 20/03/2002, T-355/00, Tele Aid, EU:T:2002:79);

‘Quickripp’ for hand tools, clamps and parts for tools and clamps (order of 27/05/2004, T-61/03, Quick-Grip, EU:T:2004:161);

‘Twist and Pour’ for hand held plastic containers sold as an integral part of a liquid paint containing, storage and pouring device (judgment of 12/06/2007, T-190/05, Twist & Pour, EU:T:2007:171);

‘CLEARWIFI’ for telecommunications services, namely high-speed access to computer and communication networks (judgment of 19/11/2009, T-399/08, Clearwifi, EU:T:2009:458);

‘STEAM GLIDE’ for electric irons, electric flat irons, electric irons for ironing clothes, parts and fittings for the aforementioned goods (judgment of 16/01/2013, T-544/11, Steam Glide, EU:T:2013:20);

- ‘GREENWORLD’ for, inter alia, gas fuels, fuels, electric power, gas for lighting, retail services in the areas of fuels, transmission and transport of electrical energy, heat, gas or water (judgment of 27/02/2015, T-106/04, Greenworld, EU:T:2015:123);
- ‘ecoDOOR’ for products on which doors have a significant impact, such as dishwashers, washing machines, vending machines, apparatus for cooking (judgment of 10/07/2014, C-126/13 P, EcoDoor, EU:C:2014:2065).

In the same way, combinations of the prefix ‘EURO’ with purely descriptive terms must be refused where the ‘EURO’ element reinforces the descriptiveness of the sign as a whole or where there is a reasonable connection between that term and the goods or services concerned. This is in line with the judgment of 07/06/2001, T-359/99, EuroHealth, EU:T:2001:151.

The following examples have been **accepted for** registration:

- GREENSEA for goods and services in Classes 1, 3, 5 and 42;
- MADRIDEXPORTA for Classes 16, 35, 36, 38, 39, 41 and 42 (judgment of 16/09/2009, T-180/07, Madridexporta, EU:T:2009:334);
- DELI FRIENDS for Classes 29, 30 and 35.

Combinations not following grammatical rules

A combination of words can be considered a descriptive indication even though it does not follow the usual grammatical rules. If, however, the combination does amount to more than the mere sum of its parts, it may be acceptable (judgment of 17/10/2007, T-105/06, WinDVD Creator, EU:T:2007:309, § 34).

- 'HIPERDRIVE' is considered descriptive of the intended purpose of setting devices for tools, despite the misspelling of the adjective 'hyper' as 'hiper' (judgment of 22/05/2014, T-95/13, Hiperdrive, EU:T:2014:270, § 33-42).

'CARBON GREEN' is descriptive for reclaimed rubber, namely, recycled carbonaceous materials, namely plastic, elastomeric, or rubber filled materials obtained from pyrolysed tire char and plastic, elastomeric, or rubber compounds formulated using such filler material, even though adjectives precede nouns in English (judgment of 11/04/2013, T-294/10, Carbon green, EU:T:2013:165).

Furthermore, in the world of advertising, definite articles and pronouns (the, it, etc.), conjunctions (or, and, etc.) or prepositions (of, for, etc.) are frequently omitted. This means that a lack of these grammatical elements will sometimes not be sufficient to make the mark distinctive.

Combinations of adjectives + nouns or verbs

For combinations consisting of nouns and adjectives, it should be assessed whether the meaning of the combination changes if its elements are inverted. For example, 'Vacations direct' (not registrable, decision of 23/01/2001, R 0033/2000-3) is tantamount to 'direct vacations', whereas 'BestPartner', is not the same thing as 'PartnerBest'.

The same reasoning applies to words consisting of the combination of an adjective and a verb. Therefore, the word 'ULTRAPROTECT' must be considered descriptive for sterilising and sanitary preparations, even though it consists of the combination (grammatically incorrect) of an adjective (ULTRA) with a verb (PROTECT), since its meaning remains clearly understandable (decision of 03/06/2013, R 1595/2012-1; see also judgment of 06/03/2012, T-565/10, Highprotect, EU:T:2012:107).

Combinations of words in different languages

Combinations made up of words from different languages may still be objectionable if the relevant consumers will understand the descriptive meaning of all the elements without further effort. This may be the case, in particular, when the sign contains basic terms in a language that will be understood easily by the speakers of another language, or if the terms are similar in both languages. For instance, if a mark is composed of one basic descriptive term belonging to language 'A' and another descriptive word in language 'B', the sign as a whole will remain descriptive when it is assumed that the speakers of language 'B' will be able to grasp the meaning of the first term.

Applications that consist of descriptive words or expressions repeated in various languages are a special case in the sense that they are mere translations of each other. These trade marks should be considered descriptive if the relevant consumer will grasp that each of the words or expressions is in fact merely the translation of a descriptive meaning, for example, because the proximity of the terms contained in the mark to each other will lead the consumer to understand that they all have the same descriptive meaning in different languages. For instance:

- CTM No 3 141 017 ‘Le salon virtuel de l’industrie — Industry virtual exhibition — Die virtuelle Industriemesse — Il salon virtuale dell’industria — El salon virtual de la industria’ for services in Classes 35, 38 and 42.

The following examples have been **refused** registration.

- CTM No 12 596 169 ‘BABYPATAUGEOIRE’ for Classes 20 and 42 related to chairs and design of chairs for babies. The sign is composed of an EN and a FR term that will be immediately understood by the French-speaking part of the public (the term ‘baby’ will be understood by the French-speaking part of the public).
- ‘EURO AUTOMATIC PAIEMENT’, for Classes 9 and 36 (judgment of 05/09/2012, T-497/11, Euro automatic paiement, EU:T:2012:402, combination of English and French terms).

2.3.2.3 Misspellings and omissions

A misspelling does not necessarily change the descriptive character of a sign. First of all, words may be misspelt due to influences of another language or the spelling of a word in non-EU areas, such as American English, in slang or to make the word more fashionable. Examples of signs that have been refused:

- ‘Xtra’ (decision of 27/05/1998, R 0020/1997-1),
- ‘Xpert’ (decision of 27/07/1999, R 0230/1998-3),
- ‘Easi-Cash’ (decision of 20/11/1998, R 0096/1998-1),
- ‘Lite’ (judgment of 27/02/2002, T-79/00, Lite, EU:T:2002:42),
- ‘Rely-able’ (judgment of 30/04/2013, T-640/11, Rely-able, EU:T:2013:225),
- ‘FRESHHH’ (judgment of 26/11/2008, T-147/06, Freshhh, EU:T:2008:528).

Furthermore, consumers will, without further mental steps, understand the ‘@’ as the letter ‘a’ or the word ‘at’ and the ‘€’ as the letter ‘e’. Consumers will replace specific numerals by words, for example, ‘2’ as ‘to’ or ‘4’ as ‘for’.

However, if the misspelling is fanciful and/or striking or changes the meaning of the word (accepted: ‘D’LICIOUS’, CTM No 13 729 348 (instead of ‘delicious’), ‘FANTASTICK’, CTM No 13 820 378 (instead of ‘fantastic’)), the sign is acceptable.

As a rule, misspellings endow the sign with a sufficient degree of distinctive character when:

- they are striking, surprising, unusual, arbitrary and/or,
- they are capable of changing the meaning of the word element or require some mental effort from the consumer in order to make an immediate and direct link with the term that they supposedly refer to.

The following marks were refused:

Sign	Reasoning	Case
<p>ACTIVMOTION SENSOR</p> <p>CTM No 10 282 614 for goods in Class 7 (swimming pool and spa cleaning equipment, namely, sweepers, vacuums, and parts therefor)</p>	<p>The mark merely consists of 'ACTIV', an obvious misspelling of the word 'ACTIVE', 'MOTION' and 'SENSOR'. Combined, the words form a perfectly comprehensible and plainly descriptive combination, and was thus refused.</p>	<p>Decision of 06/08/2012, R 0716/2012-4 – 'ACTIVMOTION SENSOR', § 11</p>
<p>XTRAORDINARIO</p> <p>International registration designating the EU No 930 778, for goods in Class 33 (tequila)</p>	<p>The above term is a non-existent word but closely resembles the Spanish adjective 'extraordinario'. Spanish and Portuguese consumers will perceive the sign as a misspelling of a word meaning 'remarkable', 'special', 'outstanding', 'superb' or 'wonderful', and as such, attribute a descriptive meaning to the sign.</p>	<p>Decision of 08/03/2012, R 2297/2011-5 – 'Xtraordinario', § 11-12</p>

However, the following marks were **accepted**:

Sign	Reasoning	Case
<p>LINQ</p> <p>CTM No 1 419 415 covering goods and services in Classes 9 and 38</p>	<p>This word is an invented word, not existing in any known dictionary, and it was not shown that this word is a common misspelling used in the trade circles of interest to the appellant. Additionally, because the word is short, the ending letter 'Q' will be noticed as a peculiar element, and thus the fanciful spelling is obvious</p>	<p>Decision of 04/02/2002, R 0009/2001-1 – 'LINQ', § 13</p>
<p>LIQID</p> <p>CTM No 5 330 832 initially covering goods in Classes 3, 5 and 32</p>	<p>In this word mark, the combination 'QI' is highly uncommon in the English language, as the letter 'Q' is normally followed by a 'U'. The striking misspelling of the word 'liquid' would allow even a consumer in a hurry to notice the peculiarity of the word 'LIQID'. Furthermore, the spelling would not only have an effect on the visual impression produced by the sign, but also the aural impression, as the sign applied for will be pronounced differently from the word 'liquid'.</p>	<p>Decision of 22/02/2008, R 1769/2007-2 – 'LIQID', § 25</p>

2.3.2.4 Abbreviations and acronyms

Abbreviations of descriptive terms are in themselves descriptive if they are used in that way, and the relevant public, whether general or specialised, recognises them as being identical to the full descriptive meaning. The mere fact that an abbreviation is derived from a descriptive term is not sufficient (judgment of 13/06/2014, T-352/12, Flexi, EU:T:2014:519).

The following signs were refused because the descriptive meaning for the relevant public could clearly be shown:

- SnTEM (judgment of 12/01/2005, T-367/02 to T-369/02, SnTEM, SnPUR & SnMIX, EU:T:2005:3),

- TDI (judgment of 03/12/2003, T-16/02, TDI, EU:T:2003:327 (appeal C-82/04 P was settled),
- LIMO (judgment of 20/07/2004, T-311/02, Limo, EU:T:2004:245),
- BioID (judgment of 05/12/2002, T-91/01, BioID, EU:T:2002:300 (appeal C-37/03 P set aside GC judgment and dismissed decision of 2nd BoA)).

Note that use of internet databases such as 'AcronymFinder.com' as a reference base should be made with the greatest care. Use of technical reference books or scientific literature are preferable, for example, in the field of computing. Alternatively, use of the abbreviation by a number of traders in the appropriate field on the internet is sufficient to substantiate actual use of the abbreviation.

Signs consisting of an independently non-descriptive acronym that precedes or follows a descriptive word combination should be objected to as descriptive if it is perceived by the relevant public as merely a word combined with an abbreviation of that word combination, for example 'Multi Markets Fund MMF'. This is because the acronym and word combination together are intended to clarify each other and to draw attention to the fact that they are linked (judgment of 30/06/2009, T-285/08, Natur-Aktien-Index, EU:T:2009:230, § 32 and 40). This will be the case even where the acronym does not account for the mere 'accessories' in the word combination, such as articles, prepositions or punctuation marks, demonstrated in the following examples:

- 'NAI – Der Natur-Aktien-Index',
- 'The Statistical Analysis Corporation – SAC'.

While the above rule will cover most cases, not all instances of descriptive word combinations juxtaposed with an abbreviation of that word will be considered descriptive as a whole. This will be the case where the relevant public will not immediately perceive the acronym as an abbreviation of the descriptive word combination, but rather as a distinctive element that will make the sign as a whole more than the sum of its individual parts, as demonstrated in the following example:

- 'The Organic Red Tomato Soup Company — ORTS'.

2.3.2.5 Slogans

A slogan is objectionable under Article 7(1)(c) CTMR when it immediately conveys the kind, quality, intended purpose or other characteristics of the goods or services.

The criteria established by case-law for the purpose of determining whether a slogan is descriptive or not are identical to those applied in the case of a word mark containing only a single element (judgment of 06/11/2007, T-28/06, Vom Ursprung her vollkommen, EU:T:2007:330, § 21). It is inappropriate to apply criteria to slogans that are stricter than those applicable to other types of signs, especially considering that the term 'slogan' does not refer to a special subcategory of signs (judgment of 12/07/2012, C-311/11 P, Wir machen das Besondere einfach, EU:C:2012:460, § 26 and 40).

Example of a descriptive slogan

- An application in Class 9 (*satellite navigation systems*, etc.) for 'FIND YOUR WAY', (decision of 18/07/2007, R 1184/2006-4) was objected to under Article 7(1)(b) and (c) CTMR. The expression FIND YOUR WAY in relation to the

goods applied for in Class 9 is clearly intended to inform the relevant consumer that the appellant's goods help consumers to identify geographical locations in order to find their way. The message conveyed by the sign applied for directly refers to the fact that consumers will discover the route for travelling from one place to another when using the specified goods.

- BUILT TO RESIST could have only one possible meaning in relation to *paper, paper goods and office requisites* in Class 16, *leather, imitations of leather, travel articles not included in other classes and saddlery* in Class 18 and *clothing, footwear and headgear* in Class 25, namely that the goods are manufactured to last and are, therefore, tough and resistant to wear and tear (judgment of 16/09/2009, T-80/07, Built to resist, EU:T:2009:332, § 27-28).

2.3.2.6 Geographical terms

A geographical term is every existing name of a place, for example a country, region, city, lake or river. This list is not exhaustive. Adjectival forms are not sufficiently different from the original geographical term to cause the relevant public to think of something other than that geographical term (judgment of 15/10/2003, T-295/01, Oldenburger, EU:T:2003:267, § 39). For example, 'German' will still be perceived as referring to Germany, and 'French' will still be perceived as referring to France. Furthermore, outdated terms such as 'Ceylon', 'Bombay' and 'Burma' fall within this scope if they are still commonly used or generally understood by consumers as a designation of origin.

It is in the **public interest** that signs that may serve to designate the geographical origin of goods or services remain available, not least because they may be an indication of the quality and other characteristics of the categories of goods concerned, and may also, in various ways, influence consumer preferences by, for instance, associating the goods or services with a place that may elicit a favourable response (judgments of 15/01/2015, T-197/13, MONACO, EU:T:2015:16, § 47; 25/10/2005, T-379/03, Cloppenburg, EU:T:2005:373, § 33).

This paragraph (2.3.2.6.) uses the words 'geographical term' to refer to **any** geographical indication in a Community trade mark application, whereas the terms 'protected geographical indication' and 'protected designation of origin' are used **only** in the context of specific legislation protecting them. Designations of origin and geographical indications protected under specific EU Regulations are dealt with under the section on Article 7(1)(j) and (k) CTMR.

If the sign contains other non-descriptive or distinctive elements, the registrability of the combination (of the sign in its entirety) must be assessed in the same manner as in cases where descriptive elements are coupled with distinctive or non-descriptive elements (see paragraph 2.3.4 below).

Assessment of geographical terms

The registration of geographical names as trade marks is not possible where such a geographical name is either **already famous**, or is **known for the category of goods concerned**, and is therefore **associated** with those goods or services in the mind of the relevant class of persons, or is liable to be used by undertakings and must remain available to such undertakings as indications of the geographical origin of the goods

and services concerned (judgments of 15/01/2015, T-197/13, MONACO, EU:T:2015:16, § 48; 25/10/2005, T-379/03, Cloppenburg, EU:T:2005:373, § 34).

As with all other descriptive terms, the test is whether the geographical term describes objective characteristics of the goods and services. The assessment must be made with reference to the claimed goods and services and with reference to the perception by the relevant public. The descriptive character of the geographical term may relate to:

- the place of production of the goods;
- the subject matter of a good (e.g. the city or region a travel guide is about);
- the place where the services are rendered;
- the kind of cuisine (for restaurants); or
- the place that influences consumer preferences (e.g. lifestyle) by eliciting a favourable response (15/01/2015, T-197/13, MONACO, EU:T:2015:16, § 47 and Cloppenburg, EU:T:2005:373, § 33).

a) First step: term understood by the relevant public

The first step in assessing a geographical term is to determine whether it is understood as such by the relevant public. Article 7(1)(c) CTMR does not in principle preclude the registration of geographical names that are unknown to the relevant public — or at least unknown as the designation of a geographical location (15/01/2015, T-197/13, MONACO, EU:T:2015:16, § 49; T-379/03, Cloppenburg, EU:T:2005:373, § 36). Whether or not this is the case will be determined by taking as a basis a reasonably well-informed consumer who has sufficient common knowledge but is not a specialist in geography. For an objection to be raised, the Office must prove that the geographical term is known by the relevant public as designating a place (15/01/2015, T-197/13, MONACO, EU:T:2015:16, § 51).

b) Second step: term designates a place associated with the goods and services

The second step is to determine whether the geographical term applied for designates a place that is currently associated with the claimed goods or services in the mind of the relevant public or whether it is reasonable to assume that such a name may, in the mind of the relevant public, designate the geographical origin of that category of goods or services (15/01/2015, T-197/13, MONACO, EU:T:2015:16, § 51, T-379/03, Cloppenburg, EU:T:2005:373, § 38), or if it will *reasonably be associated* with those goods or services *in the future* (judgment of 04/05/1999, C-108/97 & C-109/97, Chiemsee, EU:C:1999:230, § 31).

In establishing whether such an association exists, the Court has clarified that the following **factors** should be taken into account (judgment of 04/05/1999, C-108/97 & C-109/97, Chiemsee, EU:C:1999:230, § 32 and 37, T-379/03, EU:T:2005:373, § 38 *in fine*):

- the degree of familiarity of the relevant public with the geographical term
- the characteristics of the place designated by the term, and
- the category of goods or services.

It is not necessary to establish that the name actually designates the **true** geographical origin of the goods. It is enough to demonstrate that the connection between the name of the place and the goods may enable the relevant public to perceive the contested

sign as an indication of the origin of those goods (judgment of 15/10/2003, T-295/01, Oldenburger, EU:T:2003:267, § 43). For example, ‘Milano’ should be refused for *clothing*, Switzerland for *financial services* and Islas Canarias for *tourist services*.

With regard to *reasonable future association*, an Article 7(1)(c) CTMR refusal cannot be based solely on the argument that the goods or services can theoretically be produced or rendered in the place designated by the geographical term (judgment of 08/07/2009, T-226/08, Alaska, EU:T:2009:257). The abovementioned factors should be assessed (degree of familiarity of the relevant public with the geographical term, the characteristics of the place designated by the term, and the category of goods or services). In particular, such an assessment must take into account the relevance of the geographical origin of the goods in question, and the customs of the trade in using geographical names to indicate the origin of the goods or to refer to certain qualitative and objective criteria of the goods.

Sign	Reasoning	Case
BRASIL	The Board recognised that the mere existence of whisky production in Brazil was not sufficient in itself to presume that relevant consumers of whisky will associate the sign with the goods. However, it had to be assessed whether it was reasonable to assume that such an association might be established in the future. The BoA assessed a number of factors, including the fact that it is current practice in trade to indicate the geographical origin of whiskies and whisky-based beverages. It concluded that the designation ‘Brasil’ would be understood as an informative indication for whisky and whisky-based beverages (para. 29).	R 0434/2013-1
Class 32: Beers; Mineral and aerated waters and other non-alcoholic beverages; Fruit beverages and fruit juices; Syrups and other preparations for making beverages. Class 33: Whisky; whisky-based beverages.		

Sign	Reasoning	Case
THE SPIRIT OF CUBA	The GC considered that the sign would be understood by the relevant public as a reference to the alcoholic spirit of Cuba or to an alcoholic beverage from Cuba, despite the structure of the sign (‘the’, singular form, ‘of’ instead of ‘from’) (para. 26)	T-207/13
Class 33: Alcoholic beverages.		

Sign	Reasoning	Case
PORT LOUIS	The GC annulled a BoA decision because it had not established that the city of Port Louis (capital of the Republic of Mauritius) was sufficiently known by the relevant public of the former colonial powers of France and the United Kingdom. Nor was it established that Port Louis had a reputation for the relevant goods (textile manufacture) amongst the relevant public (paras 40-54)	T-230/06, ‘Port Louis’

Sign	Reasoning	Case
Class 18: Leather and imitations of leather, goods made of these materials and not included in other classes; animal skins, hides; trunks and traveling bags; umbrellas, parasols, canes and walking sticks; saddlery, harness and whips; horse blankets Class 24: Household textiles; bed and table covers; bedclothes; bath linen (except clothing); household linens; shower curtains of textile; curtains of textile or plastic; blinds of textile; coverlets; wax table cloths Class 25: Clothing, footwear, headgear.		

Geographical terms that are **merely allusive or fanciful should not be objected to** on this basis. For example, while the North Pole and Mont Blanc are commonly known geographical terms, they would not be understood in the context of ice cream or sports cars as possible places of production, but as merely allusive and fanciful terms. The same applies to the fashionable use of city/country names for goods and services unrelated to what the city/country is known for (e.g. ‘Hollywood’ for *chewing gum*, ‘Greenland’ for *fresh fruits and vegetables* (R 0691/2000-1, GREENLAND), ‘Sudan’ for *paints* (R 0594/1999-2, SUDAN), and ‘Denver’ for *lighting equipment* (R 2607/2011-2, DENVER)) and the use of names of fashionable suburbs or shopping streets (‘Champs Élysées’ for *bottled water*, ‘Manhattan’ for *tomatoes*). The same applies by analogy to ‘Port Louis’ for *textiles*.

Finally, there are some geographical terms, such as **major geographical places or regions as well as countries**, which may be refused merely because of their **widespread recognition and fame for the high quality** of their goods or services. In such cases no detailed assessment of the association between the place and the goods and services is necessary (judgment of 15/12/2011, T-377/09, *Passionately Swiss*, EU:T:2011:753, § 43-45).

Sign	Reasoning	Case
Passionately Swiss	The GC held that BoA did not need to go into a detailed assessment of the association between the sign and each of the goods and services. It based its finding on Switzerland’s reputation for quality, exclusiveness and comfort, which can be associated with the services in Classes 35, 41, 43 and 44 and the goods in Class 16 (para. 45).	T-377/09

Sign	Reasoning	Case
MONACO	The General Court found that the word 'monaco' corresponds to the name of a globally known principality, not least due to the renown of its royal family and its organisation of a Formula 1 Grand Prix and a circus festival. The Court considered that the trade mark MONACO had to be refused for goods and services in Classes 9, 16, 39, 41 and 43 as the word 'monaco' could be used, in trade, to designate origin, geographical destination or the place of supply of services. The trade mark was thus descriptive for the goods and services concerned.	T-197/13

The mere fact that a geographical term is used by only one producer is not sufficient to overcome an objection, although it is an important argument to be taken into account in assessing acquired distinctiveness.

2.3.2.7 Terms describing subject matter in goods or services

Where a sign consists exclusively of a word that describes what may be the subject matter or content of the goods or services in question, it should be objected to under Article 7(1)(c) CTMR. Commonly known terms likely to be linked to a particular thing, product or activity by the relevant public are capable of describing subject matter and should therefore be kept free for other traders (judgment of 12/06/2007, T-339/05, Lokthread, EU:T:2007:172, § 27).

The essential question is whether the sign applied for **may be used in trade in relation to the goods or services applied for** in a manner that will be undoubtedly perceived by the relevant public as descriptive of the subject matter of those claimed goods or services, and should therefore be kept free for other traders.

For example, a widely known name such as 'Vivaldi' will immediately create a link to the famous composer, just as the term 'skis' will immediately create a link to the sport of skiing. While Class 16 (books) is a prime example of a category of goods which contains subject matter or content, an objection made under this section may occur also with respect to other goods and services, such as data carriers, DVDs, CD-ROMs or editorial services. With regard to this section, the terms 'subject matter' and 'content' are used interchangeably. See also paragraph 2.2.3 above.

Names of famous persons (in particular musicians or composers) can indicate the category of goods, if due to wide spread use, the time lapse, the date of death, or the popularisation, recognition, multiple performers, or musical training, the public can understand them as generic. This would be the case, for example, with respect to 'Vivaldi', whose music is played by orchestras all over the world and the sign 'Vivaldi' will not be understood as an indicator of origin for music.

Objections based on the above:

- will apply only to goods (e.g. books) or services (e.g. education) that contain subject matter regarding other things, products and/or activities (e.g. a book about history, or an educational course on history),

- when the sign consists exclusively of the word identifying that subject matter (e.g. 'VEHICLES' or 'HISTORY'), and
- will be made on a case-by-case basis by assessing multiple factors, such as the relevant public, the degree of attention or the descriptive character of the term in question (see below).

Goods and services that may contain subject matter

For most cases, the goods or services that may consist of or contain objectionable subject matter are the following:

- Class 9: *Magnetic data carriers, software, recording discs, electronic publications (downloadable).*
 - Objectionable
 - STATISTICAL ANALYSIS for software
 - ROCK MUSIC for CDs.
- Class 16: Printed matter, photographs and teaching materials as long as these include printed matter.
 - Objectionable
 - HISTORY for books
 - PARIS for travel guides
 - CAR for magazines
 - ANIMALS for photographs
 - TRANSCENDENTAL MEDITATION for *instructional and teaching material.*
- Class 28: *Board games*
 - Objectionable
 - — 'Memory' (order of 14/03/2011, C-369/10).
- Class 35: Trade fairs, advertising, retail services.
 - Objectionable
 - ELECTRONICA for trade fairs related to electronic goods (judgment of 05/12/2000, T-32/00, Electronica, EU:T:2000:283, § 42-44)
 - LIVE CONCERT for advertising services
 - CLOTHING for retail services.
- Class 38: Telecommunications
 - Objectionable

- NEWS for telecommunications
- MATH for providing online forums.
- Class 41: Education, training, entertainment, electronic publications (non-downloadable).
 - Objectionable
 - GERMAN for language courses
 - HISTORY for education
 - COMEDY for television programmes
 - TRANSCENDENTAL MEDITATION for *education services*.

The above list of Nice classes is not exhaustive, although it will apply to the vast majority of cases. Consequently, objections based on descriptive subject matter should be raised primarily in the context of the goods and services listed above.

Where the sign applied for is a descriptive term for a particular characteristic of goods or services, a designation of goods or services that excludes that particular characteristic described by the sign applied for will not avoid an objection based on subject matter. This is because it is unacceptable for an applicant to make a claim of goods or services subject to the condition that they do not possess a particular characteristic (judgment of 12/02/2004, C-363/99, Postkantoor, EU:C:2004:86, § 114-116). The following invented examples illustrate designations of goods or services that will not avoid an objection:

- COMEDY for television broadcasting, except for comedy *programming*
- PENGUINS (in plural!) for books, except for books about *penguins*
- TECHNOLOGY for classes, except for classes about computers and *technology*.

Distinguishable from the examples above are positive claims of goods or services, under which it is impossible for the sign applied for to describe any subject matter or content. For example, the following invented examples would not be objectionable, at least with regards to signs being descriptive of subject matter:

- COMEDY for television broadcasting of economic news, politics and *technology*
- PENGUIN for comic books with country western, medieval and ancient Roman *themes*
- TECHNOLOGY for classes about creative fiction *writing*.

2.3.2.8 Single letters and numerals

Single letters³

General considerations

In its judgment of 09/09/2010, C-265/09 P (' α '), the Court stated that when examining absolute grounds for refusal, the Office is required, under Article 76(1) CTMR, to examine, of its own motion, the relevant facts which might lead it to raise an objection under Article 7(1) CTMR and that that requirement cannot be made relative or reversed, to the detriment of the CTM applicant (paras 55-58). Therefore, it is for the Office to explain, with motivated reasoning, why a trade mark consisting of a single letter represented in standard characters is descriptive.

Consequently, when examining single letter trade marks, generic, unsubstantiated arguments such as those relating to the availability of signs, given the limited number of letters, should be avoided. Similarly, it would not be appropriate to base an objection on speculative reasoning as to the different meanings that a sign could possibly have. The Office is obliged to establish, on the basis of a factual assessment, why the trade mark applied for would be objectionable.

It is therefore clear that the examination of single letter trade marks should be thorough and stringent, and that each case calls for a careful examination.

Examples

For instance, in technical domains such as those involving computers, machines, motors and tools, it may be that particular letters have a descriptive connotation if they convey sufficiently precise information about the goods and/or services concerned.

The letter 'E' was also considered to be descriptive in respect of 'wind power plants and parts thereof, generators, rotor blades for wind power plants, rotors for wind power plants' in Class 7, 'control switches for wind power plants, frequency converters, measuring, signalling and checking (supervision) instruments' in Class 9 and 'towers for wind power plants' in Class 19, since it may be seen as a reference to 'energy' or 'electricity' (judgment of 21/05/2008, T-329/06, E, EU:T:2008:161, § 24-31 and decision of 08/09/2006, R 0394/2006-1, § 22-26).

An objection might be justified also in respect of goods and/or services meant for a broader public. For example, the letters 'S', 'M' or 'L' in respect of clothing would be objectionable as these letters are used to describe a particular size of clothing, namely as abbreviations for 'Small', 'Medium' or 'Large'.

However, if it cannot be established that a given single letter is descriptive for the goods and/or services concerned, and provided that the applied for trade mark is not open to objection under another provision of Article 7(1) CTMR, then the application should be accepted.

³ This part deals with single letters under Article 7(1)(c) CTMR. For single letters under Article 7(1)(b) CTMR, see paragraph 2.2.5.

See paragraph 2.2.5.2 above for further examples of where an objection under Article 7(1)(b) CTMR may be raised.

Numerals

In its judgment of 10/03/2011, C-51/10 P, '1000', the Court of Justice ruled that signs composed exclusively of numerals with no graphic modifications may be registered as trade marks (paras 29-30).

The Court referred by analogy to its previous judgment of 09/09/2010, C-265/09 P, (α) in respect of single letters (para. 31) and emphasised that trade marks consisting of numerals must be examined by with specific reference to the goods and/or services concerned (para. 32).

Therefore, a numeral may be registered as a Community trade mark only if it is distinctive in relation to the goods and services covered by the application for registration (para. 32) and is not merely descriptive or otherwise non-distinctive in respect of those goods and services.

For example, the Board confirmed the refusal of the trade mark '15' applied for in respect of 'clothing, footwear, headgear' in Class 25, on the ground that the numeral '15' is linked directly and specifically to these goods, as it contains obvious and direct information regarding their size. The Board also confirmed the refusal of this sign in respect of 'beers' in Class 32, as practical experience of the marketing of the relevant goods — relied upon by the Office — showed that a number of very strong beers with an alcohol content of 15 % vol. exist on the Community market (decision of 12/05/2009, R 0072/2009-2 '15', § 15-22).

It is well known that numerals are often used to convey relevant information as to the goods and/or services concerned. For example, in the following scenarios an objection would apply on the ground that the sign applied for is descriptive since it refers to:

- the **date** of production of goods/provision of services, when this factor is relevant in respect of the goods/services concerned. For instance, 1996 or 2000 for *wines* would be objectionable, since the age of the wine is a very relevant factor when it comes to the purchasing choice; 2020 would be objectionable also for 'events' as it could be considered the year of an event.
- **size**: 1600 for cars, 185/65 for tyres, 10 for women's clothing in the UK, 32 for women's clothing in France,
- **quantity**: 200 for cigarettes,
- **telephone codes**: 0800 or 0500 in the UK, 800 in Italy, 902 in Spain, etc.,
- the **time** of provision of services: 24/7,
- the **power** of goods: 115 for engines or cars,
- **alcoholic content**: 4.5 for lager, 13 for wines,
- the **number of pieces**: 1 000 for puzzles.

However, where the numeral does not appear to have any possible meaning in respect of the goods and services, it is acceptable, that is to say, '77' for financial services or '333' for 'clothing'.

2.3.2.9 Names of colours

A sign consisting exclusively of the name of a colour must be objected to under Article 7(1)(c) CTMR when the application claims any goods for which the colour can reasonably be perceived by the public as a description of one of its characteristics. For example, the name of the colour BLUE in relation to cheese describes a specific kind of cheese, the colour GREEN describes a specific kind of tea. The name of the colour BROWN in relation to sugar describes the colour and kind of the sugar. This rule applies mainly to common colours, for example, primary colours or SILVER and GOLD. When the claimed goods concern colorants, such as paint, ink, dyes, cosmetics, etc., the name of colours may describe the actual colour of the goods, and signs consisting exclusively of a colour should be objected to under Article 7(1)(c) CTMR. In these cases, names of colours would not be seen as trade marks but merely as elements describing the principal characteristic of the goods.

The following guidelines should generally be applied:

- Where colour is a typical feature of the goods and relevant for consumer choice, such as clothing and motor cars, colour names such as EMERALD or APRICOT, which, although having alternative meanings, are recognised as having a strong connotation with definite colours, and should be objected to;
- Words such as SAPPHIRE, FLAMINGO or LAPISLAZULI do not have a sufficiently strong colour connotation to overwhelm the other non-colour meaning, and thus should generally not be objected to if they are not likely to be perceived as having a colour meaning with respect to the claimed goods or services (decision of 12/12/2013, 7950 C).

Colours in combination with other words may be registrable if the sign as a whole is distinctive: ICE COFFEE, VANILLA ICE and MISTY BLUE. Descriptive combinations such as DEEP BLUE should not be accepted. Dictionary words that are descriptive but obscure and unlikely to be used by others can be accepted: LUNA (alchemists' name for silver) and CARNELIAN (an alternative name for CORNELIAN, a red gem stone that is less well known).

2.3.2.10 Plant variety names

Plant variety names describe cultivated varieties or subspecies of live plants or agricultural seeds. As such, they will not be perceived as trade marks by the relevant public.

This section only concerns plant variety names that happen to be used in trade but which are not simultaneously registered by the Community Plant Variety Office in accordance with Council Regulation (EC) No 2100/94 of 27/07/1994. How to deal with CTMs applied for that contain or consist of a registered plant variety name is explained in another section of the Guidelines, in the context of Article 7(1)(f) CTMR (see paragraph 2.6.1.2 below).

The criteria for assessing the descriptiveness of a trade mark for plants are no different from those applicable to other categories of trade marks. The provisions of trade mark law apply to plants in the same way as they apply to other categories of goods. It follows that the name of a plant variety must be rejected under Article 7(1)(c) CTMR unless it has acquired distinctiveness under the conditions of Article 7(3) CTMR.

Whenever a CTM application consists of wordings for live plants, agricultural seeds, fresh fruits, fresh vegetables or equivalent ones, the Office will have to verify, by means of a search on the internet, whether the term making up the trade mark applied for coincides with the name of a specific plant variety that happens to be already used in trade.

If the search discloses that the term in question is already used in trade either in the EU or in another jurisdiction, then the Office must raise an objection under Article 7(1)(c) CTMR, objecting that the term in question describes the nature of the goods concerned.

Depending on the circumstances of the case, and provided the evidence available demonstrates that the term in question has been used to such an extent as to have become customary in trade in the EU, then an objection both under Article 7(1)(c) and (d) CTMR would be appropriate (see also paragraph 2.4.4 below).

For example, in its decision of 01/03/2012, R 1095/2011-5 SHARBATI, the Fifth Board of Appeal confirmed the refusal of the trade mark 'SHARBATI' applied for in respect of *rice; flour and preparations made from cereals, bread, pastry and confectionery* in Class 30, since it is descriptive thereof: Sharbati is a type of rice as well as a type of wheat that gives its name to a certain kind of flour, known in India.

Even though most of the evidence provided had its source in India, part of it referred to export trade on commodities markets. Therefore, the fact that a certain word is the name of a rice variety in India was already a strong indication that the product would be distributed in the European Union.

However, the Board considered that there was not sufficient evidence that the term SHARBATI had become generic in the European Union. Even though it had been demonstrated that Sharbati rice or Sharbati wheat had been offered to traders in the European Union, actually imported into the European Union and that there was no other precise name for that product, there was insufficient evidence that, at the filing date of the CTM application, the products were known to the extent required under Article 7(1)(d) CTMR.

An objection should also be raised when the applied for trade mark is only a **slight variation** (i.e. minor differences that do not alter the visual and aural perception of the sign) of the plant variety name used in trade, thus inducing consumers to believe that they are confronted with the descriptive or generic name of a plant variety.

Another example in this respect is to be found in decision of 03/12/2009, R 1743/2007-1, VESUVIA. The Board held that evidence that had its source in the United States and Canada was sufficient to conclude that the name 'Vesuvius' of a variety of roses *may* become a descriptive indication within the European Union in the sense of Article 7(1)(c) CTMR and that the trade mark applied for, 'VESUVIA', came close to it. The Board justified its refusal with the fact that roses are usually referred to in the feminine form.

Lastly, it should be noted that an objection should be raised not only in respect of applied for trade marks that are identical to (or are slight variations of) a plant variety name that is already used in trade, but also in respect of any good and/or service **that** can be directly linked to the plant variety name in question (for example, import-export of the plant variety in question).

2.3.2.11 Names of banks and newspapers/magazines

In the field of banks, newspapers and magazines, consumers are accustomed to recognising descriptive combinations of terms as badges of origin. This is due to:

- the relevant entity being identified as the only one with the right to use the combination (see, for example 'BANK OF ENGLAND' or 'BANCO DE ESPAÑA' or other central/national banks names) or
- the combination being likely to identify a specific entity (see, for example, 'DIARIO DE LAS PROVINCIAS DE VALENCIA', 'BANCO AZTECA' or 'BANCO GALLEGO')

In these cases, no objection should be raised. Nevertheless, descriptive combinations such as 'ONLINEBANK', 'E-BANK' or 'INTERNETNEWS' remain objectionable since they do not create, at least prima facie, the impression of a clearly identifiable entity.

2.3.2.12 Names of hotels

In the hotel sector, hotel names often consist of the combination of the word 'HOTEL' together with a geographical term (i.e. the name of an island, a city, a country etc.). They usually indicate specific establishments that do not have any link with the geographical term they refer to, since they are not situated in that specific location. Consequently, due to these trade habits, consumers would not perceive expressions such as 'HOTEL BALI', 'HOTEL BENIDORM' or 'HOTEL INGLATERRA' as descriptive indications (describing that the services are provided by a hotel that is situated in that specific location) but rather as badges of origin.

Indeed, such expressions are not equivalent to the grammatically correct ones 'HOTEL IN BALI', 'HOTEL DE BENIDORM' or 'HOTEL EN INGLATERRA', which are clearly objectionable. This is even truer in cases where the hotel name consists of the names of two different cities, (or of two geographical terms in general), for example 'HOTEL LONDRES SAN SEBASTIAN'. Indeed, in this case the presence of the wording SAN SEBASTIAN (a city in the north of Spain) clearly indicates that 'HOTEL LONDRES' must be regarded as a fanciful expression. Therefore, no objection should be raised.

Nevertheless, in those cases where the geographical term precedes the word 'HOTEL', the situation may change according to the different languages. For example, in English the wording 'BALI HOTEL', would be perceived as an expression merely indicating any hotel located in the island of Bali, which is clearly objectionable. Consequently, each case should be assessed on its own merits. Finally, descriptive combinations such as 'LEADING HOTELS' remain objectionable since they do not create, at least prima facie, the impression of a clearly identifiable entity.

2.3.2.13 Combinations of names of countries/cities with a number indicating a year

Marks consisting of the combination of the name of a country/city with a number indicating a year must be refused under Article 7(1)(b) and (c) CTMR for all the goods and services claimed.

As an example, the mark 'GERMANY 2006' has been considered as a descriptive indication for a wide list of goods and services, ranging from *unexposed films* in Class 1 to *vehicle maintenance* in Class 37. In particular, the decision in case R 1467/2005-1 of 21/07/2008 stated that this mark:

- is descriptive of the kind and content of those services 'of actually preparing, organising and promoting an event in Germany in 2006' (*ibidem*, para. 29, referring to the organisation of sporting events related to or associated with football championships, etc.);
- is descriptive of 'the purpose and thereby in part the level of quality of goods or services, during such competitions in Germany in the year 2006, as being suitable for competitions of the highest standard or that it has been successfully used in the context of such competitions' (*ibidem*, para. 30, referring to medical instruments, soccer balls, etc.);
- qualifies the goods as souvenir articles (*ibidem*, para. 31, referring to goods such as stickers, confetti, pyjamas, etc.).

With regard to souvenir articles, the Board underlined that 'merchandising and co-branding is not limited to "classic" souvenir products. It is public knowledge that there is a tendency to try to find new markets by combining various goods with the brand of some other unrelated popular event or names' (*ibidem*, para. 34, referring to goods such as eyeglasses, televisions, toilet paper, etc., all related to or associated with football championships).

2.3.2.14 INN codes

International Nonproprietary Names (INN) are assigned to pharmaceutical substances by the World Health Organisation (WHO), so that each substance can be recognised by a unique name. These names are needed for the clear identification, safe prescription and dispensing of medicines, and for communication and exchange of information among health professionals. INNs can be used freely because they are in the public domain. Examples of INNs are alfacalcido, calcifediol, calcipotriol.

Stems define the pharmacologically related group to which the INN belongs. INN stems serve to indicate the mode of action of groups of drugs. These stems and their definitions have been selected by WHO experts and are used when selecting new international non-proprietary names. An example of a stem is 'calci'.

The criteria for assessing the descriptiveness of a trade mark for pharmaceuticals are no different from those applicable to other categories of trade marks. The provisions of trade mark law apply to pharmaceuticals in the same way as to other categories of goods. The European Medicines Agency (EMA) assesses the single name under which a medicinal product will be marketed as part of its marketing authorisation for the European Union. EMA's assessment is based on public health concerns and takes into account the WHO World Health Assembly resolution (WHA46.19) on protection of

INNs/INN stems to prevent any potential risk of confusion. The Office's assessment of the registrability of pharmaceutical trade marks, however, has no specific legal basis for taking such health-related concerns into consideration (by analogy, judgment of 05/04/2006, T 202/04, Echinaid, EU:T:2006:106, § 31-32).

Considering the descriptive nature of INN codes and stems, an objection should be raised for Class 5 in the following scenarios:

- where the CTM is an INN (the general rules on misspellings also apply, see paragraph 2.3.2.3 above); or
- where an INN appears within a CTM and the other elements of the CTM are descriptive/non-distinctive too (for instance BIO, PHARMA, CARDIO, MED, DERMA); or
- where the CTM consists only of a stem.

A list of INN codes can be accessed after online registration on MedNet (<https://mednet-communities.net>). A list of common stems is available at the following link: http://www.who.int/medicines/services/inn/StemBook_2011_Final.pdf.

Office practice is to accept figurative trade marks containing INN codes or stems, applying the same criteria as to any other figurative trade mark containing descriptive word elements (i.e. whether the stylisation and/or the graphical features of a sign are sufficient for it to act as a trade mark).

An objection may also be based on Article 7(1)(g) CTMR in the unlikely scenario that the list of goods in Class 5 refers to a different kind of drug from that covered by the INN. Where the list in Class 5 includes *pharmaceuticals*, the Office assumes good faith and no objection under Article 7(1)(g) CTMR will be raised.

2.3.3 Figurative marks

Signs represented in languages other than Latin, Greek or Cyrillic are considered for formality purposes as figurative trade marks. However, this does not mean that the semantic content of these signs will not be taken into consideration for the purpose of the application of Article 7(1)(c).

Where a figurative mark consists exclusively of a basic natural form that is not significantly different from a true-to-life portrayal that serves to indicate the kind, intended purpose or other characteristic of the goods or services, it should be objected to under Article 7(1)(c) CTMR as descriptive of a characteristic of the goods or services in question.

Sign	Case
	<p>Judgment of 08/07/2010, T-385/08 'Representation of a dog'</p>

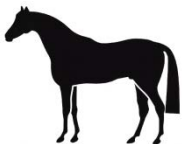
Sign	Case
	<p>Judgment of 08/07/2010, T-386/08 'Representation of a horse'</p>

In these cases the General Court held that for goods in Classes 18 and 31, the depiction of a dog or horse, respectively, serves to indicate the type of animal for which the goods are intended.

In the first case, the Court noted that the goods in Class 18 were specially produced for dogs, such as dog leads, dog collars and other dog accessories including bags. In the field of animal accessories, it is common practice for true-to-life or stylised but realistic portrayals of animals to be used for indicating the type of animal concerned. Therefore, for the goods in Class 18, the relevant public will immediately perceive the image's message that those goods are for dogs, without any further mental steps. The portrayal of a dog, therefore, indicates an essential characteristic of the goods concerned. The sign applied for is, therefore, descriptive (paras 25-28).

The same applies to goods in Class 31. As foodstuffs for domestic animals include dog food, the mark applied for is a descriptive indication for the goods at issue that will be immediately understood by the relevant public (para. 29).

In the second case, the Court held that for *clothing, headgear and belts* in Class 25, the portrayal of a horse was descriptive of the kind or intended purpose of the goods, namely that they are particularly developed or suitable for horse riding. As the relevant public would make a direct link between a horse and horse riding, the Court maintained that there was an immediate and concrete link between the portrayal of a horse and the goods concerned (paras 35-38).

By way of example, the sign below was held to be sufficiently highly stylised to significantly differ from a true-to-life portrayal serving to indicate the kind or intended purpose of the goods or services, and, thus, was registered.

Sign	CTM No	Goods and services
	<p>CTM No 844</p>	<p>Classes 1, 3, 5, 6, 7, 8, 9, 11, 16, 17, 18, 19, 20, 21, 22, 26, 28, 31, 41, 42</p>

2.3.4 Figurative threshold

2.3.4.1 Preliminary remarks

Terms or signs that are non-distinctive, descriptive or generic may be brought out of the scope of a refusal based on Article 7(1)(b), (c) or (d) CTMR if combined with other elements that make the sign as a whole distinctive. In other words, refusals based on Article 7(1)(b), (c) and/or (d) may not apply to signs consisting of a non-distinctive,

descriptive or generic element combined with other elements that take the sign as a whole beyond a minimum level of distinctiveness.

In practice this means that one of the main questions that the Office must answer is whether the mark is figurative enough to reach the minimum degree of distinctive character that is required for registration.

Finally, the fact that a sign contains figurative elements does not prevent it from still being misleading or contrary to public order or accepted principles of morality or from falling under other grounds of refusal, such as those set forth by Article 7(1)(h), (i), (j) and (k) CTMR.

Sign	CTM No	Goods and services
	<p>CTM No 8 384 653</p>	<p>Classes 33, 35 and 39</p>
<p>(09/03/2012, T-417/10, ¡Que buena ye! Hijoputa, EU:T:2012:120)</p> <p>The application was rejected since 'Hijoputa' is an offensive and vulgar word in Spanish. The application was considered to be against accepted principles of morality (irrespective of the figurative elements of the sign) protected under Article 7(1)(f) CTMR.</p>		

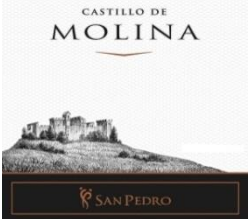
Sign	CTM No	Goods and services
	<p>CTM No 11 402 781</p>	<p>Class 33</p>
<p>The application was refused on the basis of Article 7(1)(j) CTMR, because it contains the protected geographical indication for wines 'MOLINA' (protected under the agreement <i>establishing an association between the European Community and its Member States, of the one part, and the Republic of Chile, of the other part</i>). The distinctive figurative elements of the sign are irrelevant.</p>		

2.3.4.2 Assessment of the figurative threshold

The presence of figurative elements may give distinctive character to a sign consisting of a descriptive and/or non-distinctive word element so as to render it eligible for registration as a CTM. Therefore, the question to be considered is whether the stylisation and/or the graphical features of a sign are sufficiently distinctive for the sign to act as a badge of origin.

The examples below are taken from CP3 (Convergence Programme 3), where The IP offices of the European Trade Mark and Design Network agreed on a Common Practice in relation to when a figurative mark, containing purely descriptive/non-distinctive words, should pass the absolute grounds examination because the figurative element renders sufficient distinctive character.

The signs containing 'Flavour and aroma' seek protection for coffee in Class 30, the signs containing 'Fresh sardine' and 'Sardines' seek protection for sardines in Class 29, the sign containing 'DIY' seeks protection for **kits of parts for assembly into furniture** in Class 20 the signs containing 'Pest control services' seek protection for pest control services in Class 37, and the sign containing 'Legal advice services' seeks protection for legal services in Class 45.

Stylised word elements

- Typeface and font

In general, descriptive/non-distinctive word elements appearing in basic/standard typeface, lettering or handwritten style typefaces — with or without font effects (bold, italics) — are not registrable.

Non-distinctive examples:

Fresh Sardine *Fresh Sardine* FrEsh SaRdine
Flavour and aroma *Flavour and aroma* *Flavour and aroma*

Where standard typefaces incorporate elements of graphic design as part of the lettering, those elements need to have sufficient impact on the mark as a whole to render it distinctive. When these elements are sufficient to distract the attention of the consumer from the descriptive meaning of the word element or likely to create a lasting impression of the mark, the mark is registrable.

Distinctive examples:

flavour and aroma **FLAVOUR AND AROMA** **DIY**

- Combination with colour

The mere 'addition' of a single colour to a descriptive/non-distinctive word element, either to the letters themselves or as a background, will not be sufficient to give the mark distinctive character.

Use of colours is common in trade and would not be seen as a badge of origin. However, it cannot be excluded that a particular arrangement of colours, which is unusual and can be easily remembered by the relevant consumer, could render a mark distinctive.

Non-distinctive examples:



- Combination with punctuation marks and other symbols

In general, the addition of punctuation marks or other symbols commonly used in trade does not add distinctive character to a sign consisting of descriptive/non-distinctive word elements.

Non-distinctive examples:

FreshSardine .™ “**Flavour and aroma**”

- Position of the word elements (sideways, upside-down, etc.)

In general, the fact that the word elements are arranged in vertical, upside-down or in one or more lines is not sufficient to endow the sign with the minimum degree of distinctive character that is necessary for registration.

Non-distinctive examples:

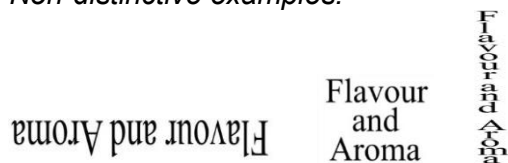

However the way in which the word elements are positioned can add distinctive character to a sign when the arrangement is of such a nature that the average consumer focuses on it rather than immediately perceiving the descriptive message.

Distinctive examples:



Word element(s) and additional figurative element(s)

- Use of simple geometric shapes

Descriptive or non-distinctive verbal elements combined with simple geometric shapes such as points, lines, line segments, circles, triangles, squares, rectangles, parallelograms, pentagons, hexagons, trapezia and ellipses are unlikely to be acceptable, in particular when the abovementioned shapes are used as a frame or border.

Non-distinctive examples:



However, geometric shapes can add distinctiveness to a sign when their presentation, configuration or combination with other elements creates a global impression that is sufficiently distinctive.

Distinctive examples:

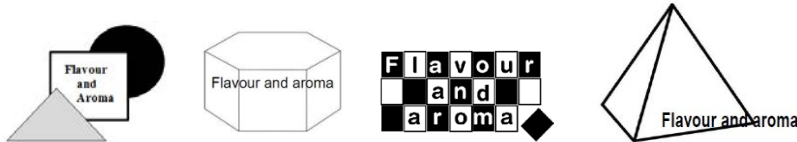

- Position and proportion (size) of the figurative element in relation to the word element

In general, when a figurative element that is distinctive on its own is added to a descriptive and/or non-distinctive word element, then the mark is registrable, provided that said figurative element is, due to its size and position, clearly recognisable in the sign.

Non-distinctive examples:

Flavour and aroma *Fresh Sardine*

Distinctive example:



- the figurative element is a representation of, or has a direct link with, the goods and/or services

A figurative element is considered to be descriptive and/or devoid of distinctive character whenever:

- It is a true-to-life portrayal of the goods and services.
- It consists of a symbolic/stylised portrayal of the goods and services that does not depart significantly from the common representation of said goods and services.

Non-distinctive examples:



Distinctive examples:



A figurative element that does not represent the goods and services but has a direct link with the characteristics of the goods and services will not render the sign distinctive, unless it is sufficiently stylised.

Non-distinctive example:



Distinctive example:



the figurative element is commonly used in trade in relation to the goods and/or services applied for

In general, figurative elements that are commonly used or customary in trade in relation to the goods and/or services claimed do not add distinctive character to the mark as a whole.

Non-distinctive examples:



Stylised word elements and additional figurative element(s)

In general, a combination of figurative elements and word elements, which if considered individually are devoid of distinctive character, does not give rise to a distinctive mark.

Nevertheless, a combination of such elements when considered as a whole could be perceived as a badge of origin due to the presentation and composition of the sign. This will be the case when the combination results in an overall impression that is sufficiently far removed from the descriptive/non-distinctive message conveyed by the word element.

Examples: In order for a sign to be registrable, it must have a minimum level of distinctiveness. The purpose of the scale is to illustrate where that threshold is. The examples below from left to right contain elements with an increasing impact on the distinctiveness of the marks, resulting in marks which are either non-distinctive in their totality (red column) or distinctive in their totality (green column).

<p>1.</p>	
<p>2.</p>	
<p>3.</p>	

2.4 Customary signs or indications (Article 7(1)(d) CTMR)

2.4.1 General remarks

Article 7(1)(d) CTMR excludes from registration signs that consist exclusively of words or indications that have become customary in the current language or in the bona fide and established practices of the trade at the relevant point in time (see paragraph 2.4.2 below). In this context, the customary nature of the sign usually refers to something other than the properties or characteristics of the goods or services themselves.

Although there is a clear overlap between the scope of Article 7(1)(d) and Article 7(1)(c) CTMR, signs covered by Article 7(1)(d) CTMR are excluded from registration not because they are descriptive, but on the basis of their current usage in trade sectors covering the goods or services for which the mark is applied for (judgment of 04/10/2001, C-517/99, Bravo, EU:C:2001:510, § 35).

Moreover, signs or indications that have become customary in the current language or in the bona fide and established practices of the trade to designate the goods or services covered by that sign are not capable of distinguishing the goods or services of one undertaking from those of other undertakings and do not, therefore, fulfil the essential function of a trade mark (judgment of 16/03/2006, T-322/03, Weisse Seiten, EU:T:2006:87, § 52).

This ground for refusal also covers words **that** originally **had** no meaning or had another meaning, for example, 'weiße Seiten' (= 'white pages'). It also covers certain abbreviations that have entered informal or jargon usage and have thereby become customary in trade.

Furthermore, a refusal based on Article 7(1)(d) CTMR also covers figurative elements that are either frequently used pictograms or similar indications or have even become the standard designation for goods and services, for example a white 'P' on a blue background for parking places, the Aesculapian staff for pharmacies, or the silhouette of a knife and fork for restaurant services.

Sign	Reasoning	Case No
 <p data-bbox="236 555 539 607">CTM No 9 894 528 covering goods in Class 9</p>	<p data-bbox="555 275 1093 633">'This device is identical to the international safety symbol known as "high voltage symbol" or "caution, risk of electric shock" ... It has been officially defined as such by the ISO 3864 as the standard high voltage symbol, whereby the device applied for is contained within the triangle which denotes that it is a hazard symbol ... Consequently, since it essentially coincides with the customary international sign to indicate a risk of high voltage, the Board deems it to be ineligible for registration as a Community trade mark in accordance with Article 7(1)(d) CTMR' (paragraph 20)</p>	<p data-bbox="1153 409 1315 439">R 2124/2011-5</p>

2.4.2 Point in time of a term becoming customary

The customary character must be assessed with reference to the filing date of the CTMA (judgments of 05/03/2003, T-237/01, BSS, EU:T:2003:54, § 46; 05/10/2004, C-192/03 P, BSS, EU:C:2004:587, § 39-40). Whether a term or figurative element was non-descriptive or distinctive long before that date, or when the term was first adopted, will in most cases be immaterial, since it does not necessarily prove that the sign in question had not become customary by the filing date (judgment of 05/03/2003, T-237/01, BSS, EU:T:2003:54, § 47; similarly, judgment of 21/05/2014, T-553/12, BATEAUX MOUCHES, EU:T:2014:264).

In some cases, a sign applied for may become customary after the filing date. Changes in the meaning of a sign that lead to a sign becoming customary after the filing date do not lead to a declaration for invalidity *ex tunc* under Article 52(1)(a) CTMR, but can lead to a revocation with effect *ex nunc* under Article 51(1)(b) CTMR. For example, the CTM registration 'STIMULATION' was cancelled on the grounds that it had become a term customarily used in relation to energy drinks. For further information, see the Guidelines, Part D, Cancellation, Section 2, Substantive Provisions.

2.4.3 Assessment of customary terms

Whether a mark is customary must be assessed, firstly, by reference to the goods or services in respect of which registration is sought, and, secondly, on the basis of the target public's perception of the mark (judgment of 07/06/2011, T-507/08, 16PF, EU:T:2011:253, § 53).

As regards the **link with the goods and services** in respect of which registration is sought, Article 7(1)(d) CTMR will not apply where the mark consists of a more general laudatory term that has no particular customary link with the goods and services concerned (judgment of 04/10/2001, C-517/99, Bravo, EU:C:2001:510, § 27, 31).

As regards the relevant public, the customary character must be assessed by taking account of the expectations that the average consumer, who is deemed to be reasonably well informed and reasonably observant and circumspect, is presumed to have in respect of the type of goods in question (judgment of 16/03/2006, T-322/03, Weisse Seiten, EU:T:2006:87, § 50). The Court has clarified a number of issues in this respect:

The relevant public to be taken into account in determining the sign's customary character comprises not only all consumers and end users but also, depending on the features of the market concerned, all those in the trade who deal with that product commercially (judgments of 29/04/2004, C-371/02, Bostongurka, EU:C:2004:275, § 26; 06/03/2014, C-409/12, Kornspitz, EU:C:2014:130, § 27).

- Where the trade mark targets both **professionals and non-professionals** (such as intermediaries and end users), it is sufficient for a sign to be refused or revoked if it is perceived to be a usual designation by any one sector of the relevant public, notwithstanding the fact that another sector may recognise the sign as a badge of origin (judgment of 06/03/2014, C-409/12, Kornspitz, EU:C:2014:130, § 23-26).

The General Court has held that Article 7(1)(d) CTMR is not applicable when the sign's use in the market is by one **sole** trader (other than the CTM applicant) (judgment of 07/06/2011, T-507/08, 16PF, EU:T:2011:253). In other words, a mark will not be regarded as customary purely for the simple reason that a competitor of the CTM applicant also uses the sign in question. For customary character to be demonstrated, it is necessary for the examiner to provide evidence (which will generally come from the internet) that the relevant consumer has been exposed to the mark in a non-trade mark context and that, as a result, they recognise its customary significance vis-à-vis the goods and services claimed.

2.4.4 Applicability of Article 7(1)(d) CTMR in relation to plant variety names

The issue of generic character may arise in the context of the examination of trade marks that consist exclusively of the name of a plant variety that is not simultaneously registered by the Community Plant Variety Office in accordance with Regulation No 2100/94. In the latter case, the mark would be objectionable under Article 7(1)(f) CTMR.

Therefore, if the evidence available shows that a given plant variety name has become customary in the European Union as the generic denomination of the variety in question, then the examiners — in addition to objecting to the trade mark applied for under Article 7(1)(c) and (b) CTMR on the ground that the trade mark applied for is descriptive — should also object under Article 7(1)(d) CTMR on the additional ground that the trade mark consists exclusively of a term that has become generic in the relevant field of trade in the European Union. See paragraphs 2.3.2.10 and 2.6.1.2, Plant variety names.

2.5 Shapes with an essentially technical function, substantial aesthetic value or resulting from the nature of the goods (Article 7(1)(e) CTMR)

2.5.1 General remarks

Article 7(1)(e) CTMR excludes from registration signs that consist exclusively of (i) the shape that results from the nature of the goods themselves; (ii) the shape of goods that is necessary to obtain a technical result; or (iii) the shape that gives substantial value to the goods.

The wording of this provision infers that it does not apply to signs for which registration is sought in respect of services.

Article 7(1)(e) CTMR does not define the category of mark that must be considered as a shape within the meaning of that provision. It makes no distinction between **2D or 3D** shapes, or **2D** representations of **3D shapes**. Therefore, the applicability of Article 7(1)(e) CTMR is not confined to 3D shapes but also applies to other categories of marks such as figurative signs representing shapes (judgment of 6/03/2014, C-337/12, Surface covered with circles, EU:C:2014:129, § 55).

The **objective** pursued by Article 7(1)(e) CTMR is the same for all of its three grounds, namely to prevent the exclusive and permanent rights that a trade mark confers from serving to extend the life of other rights indefinitely, such as patents or designs, which the EU legislature has sought to make subject to limited periods (judgments of 18/09/2014, C-205/13, Hauck, EU:C:2014:2233, § 19-20; 14/09/2010, C-48/09 P, Lego brick, EU:C:2010:516, § 43; 6/10/2011, T-508/08, Loudspeaker, EU:T:2011:575, § 65).

Importantly, unlike in the situation covered by Article 7(1)(b) CTMR, the **average consumer's perception is not a decisive element** when applying the ground for refusal under Article 7(1)(e) CTMR, but, **at most**, may be a relevant criterion for assessment by the Office when the latter identifies the sign's essential characteristics (judgment of 18/09/2014, C-205/13, Hauck, EU:C:2014:2233, § 34).

For these reasons, **an objection under Article 7(1)(e) CTMR** to marks consisting of shapes that follow from the nature of the goods, shapes that are necessary to obtain a technical result or shapes giving substantial value to the goods cannot **be** overcome by demonstrating that they have acquired distinctive character. In other words, Article 7(3) CTMR is not applicable to such shapes, regardless of whether that particular shape might actually be distinctive in the marketplace.

It is therefore advisable to **undertake a prior examination of the sign under Article 7(1)(e) CTMR where several of the absolute grounds for refusal provided for in Article 7(1) CTMR may apply** (judgment of 6/10/2011, T-508/08, Loudspeaker, EU:T:2011:575, § 44).

For the sake of sound administration and economy of proceedings, the Office will raise any objections to registration of the sign under Article 7(1) CTMR, including Article 7(1)(e) CTMR, as soon as possible and preferably all at once, even if an objection under Article 7(1)(e) CTMR based on the facts in question is less evident than, for instance, an objection for a lack of distinctiveness under Article 7(1)(b) CTMR.

It may also be the case that following an initial objection under Article 7(1)(b) and/or (c) CTMR, the evidence submitted by the applicant shows that the sign consists exclusively of a shape as listed in Article 7(1)(e) CTMR. In these cases, a further objection under Article 7(1)(e) should be raised as well.

A sign consists '**exclusively**' of the shape of goods when all its essential characteristics – that is, its most important elements – result from the nature of the goods (Article 7(1)(e)(i) CTMR), perform a technical function (Article 7(1)(e)(ii) CTMR) or give substantial value to the goods (Article 7(1)(e)(iii) CTMR). The presence of one or more minor arbitrary elements, therefore, will not alter the conclusion (judgment of 18/09/2014, C-205/13, Hauck, EU:C:2014:2233, § 21-22; judgment of 14/09/2010, C-48/09 P, Lego brick, EU:C:2010:516, § 51-52). However, an objection under Article 7(1)(e) CTMR would not be justified if the sign applied for were to consist of a

shape combined with additional, distinctive matter (whether word and/or figurative elements) as the sign in its entirety would then not consist exclusively of a shape (see the Guidelines, Part B, Examination, Section 4, Absolute Grounds for Refusal, paragraph 2.2.12.3, Step 3).

The correct application of Article 7(1)(e) CTMR requires that the **essential characteristics of the sign at issue be properly identified**, and that the assessment may be based either on the overall impression that it produces or an examination of each of its components (judgments of 18/09/2014, C-205/13, Hauck, EU:C:2014:2233, § 21; 14/09/2010, C-48/09 P, Lego brick, EU:C:2010:516, § 70).

This identification may, depending on the case and particularly in view of its degree of difficulty, be carried out by means of a simple visual analysis of the sign or, on the other hand, be based on a detailed examination in which relevant assessment criteria may be taken into account, such as surveys or expert opinions, or data relating to intellectual property rights conferred previously for the goods concerned such as patents (judgment of 14/09/2010, C-48/09 P, Lego brick, EU:C:2010:516, § 71, 85).

Once the sign's essential characteristics have been identified, it will have to be established whether they all **fall under the respective ground set out in Article 7(1)(e) CTMR** (judgment of 14/09/2010, C-48/09 P, Lego brick, § 72). In this respect, each of the three grounds must be applied independently of the others. In addition, where none of those grounds is fully applicable for the entire shape, they do not preclude registration of the sign (judgment of 18/09/2014, C-205/13, Hauck, EU:C:2014:2233, § 39, 42). Therefore, if parts of the shape are necessary to obtain a technical result within the meaning of Article 7(1)(e)(ii) CTMR, for instance, and the remaining parts merely give substantial value to the goods under Article 7(1)(iii) CTMR, neither of these two provisions bars the registration of the shape as a sign.

2.5.2 Shape that results from the nature of the goods

Under Article 7(1)(e)(i) CTMR, signs that consist exclusively of the shape that results from the nature of the goods themselves cannot be registered.

This ground of refusal will apply when the sign, whether 2D or 3D, consists exclusively of the only natural shape possible for the goods: for example, the realistic representation below of a banana for bananas:



Furthermore, the application of Article 7(1)(e)(i) CTMR cannot be limited to apply only to signs that consist exclusively of shapes that are indispensable to the function of the goods in question. Apart from **'natural' products** (which have no substitute) and **'regulated' products** (the shape of which is prescribed by legal standards), all shapes with essential characteristics that are **inherent to the generic function or functions** of such goods must, in principle, also be denied registration (judgment of 18/09/2014, C-205/13, Hauck, EU:C:2014:2233, § 23-25).

The Court of Justice has not given any further guidance about exactly when a shape is inherent to the generic function(s) of goods. In the absence of any case-law in this respect, the examples given by the Advocate General may be referred to: legs with a horizontal level for a table; an orthopaedic-shaped sole with a V-shaped strap for flip-flops (opinion of 14/05/2014, C-205/13, § 59). Even considering that the opinion of the Advocate General is not binding, it can give useful guidance.

In all cases where the CTM applied for consists exclusively of the shape of the goods that follows from their nature, an objection may additionally be raised under Article 7(1)(b) and/or (c) CTMR, on the ground that the shape in question lacks distinctive character and/or is descriptive of the nature of the goods.

2.5.3 Shape of goods necessary to obtain a technical result

Article 7(1)(e)(ii) CTMR excludes from registration signs that consist exclusively of the shape of goods that is necessary to obtain a technical result.

The Court of Justice has rendered two leading judgments concerning the subject of essentially functional shapes, which provide guidance concerning the examination of trade marks consisting exclusively of functional shapes (preliminary ruling of 18/06/2002, C-299/99, Remington, EU:C:2002:377, and judgment of 14/09/2010, C-48/09 P, Lego brick, EU:C:2010:516), interpreting, inter alia, Article 3(1) TMD, which is the equivalent of Article 7(1) CTMR.

A sign consists ‘exclusively’ of the shape of goods that is necessary to obtain a technical result when all the essential characteristics of a shape perform a technical function, the presence of non-essential characteristics with no technical function being irrelevant in that context (judgment of 14/09/2010, C-48/09 P, Lego brick, § 51). The fact that there may be alternative shapes, with other dimensions or another design, capable of achieving the same technical result does not in itself preclude the application of this provision (judgment of 14/09/2010, C-48/09 P, Lego brick, EU:C:2010:516, § 53-58).

In assessing a CTM application against Article 7(1)(e)(ii) CTMR, consideration should be given to the meaning of the expression ‘technical result’. This expression should be interpreted broadly and includes shapes that, for example:

- fit with another article;
- give the most strength;
- use the least material;
- facilitate convenient storage or transportation.

In the ‘Red Lego Brick’ case, following a cancellation action, two instances of the Office declared the 3D shape of a building block in a construction toy set as invalid:

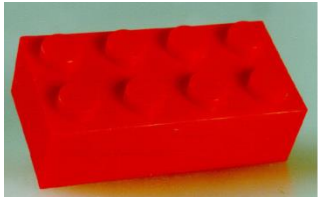
Sign	CTM No	Goods and services
	CTM No 107 029 R 856/2004 G T-270/06 C-48/09 P	Class 28 (construction toys)

In particular, the Grand Board held that the various features of the ‘Red Lego brick’ all performed particular technical functions, namely (i) *the bosses [studs]*: height and diameter for clutch power; number for fixing versatility; layout for fixing arrangement; (ii) *the secondary projections*: clutch-power; the number for best clutch-power in all positions; the thickness of the wall to act as a spring; (iii) *the sides*: connected with sides of other bricks to produce a wall; (iv) *the hollow skirt*: to mesh with the bosses and to enable fixing for clutch power and (v) *the overall shape*: brick shape for building; size for children to hold (decision of 10/07/2006, R 0856/2004-G, § 54).

The General Court dismissed the appeal against the above decision and confirmed the findings of the Grand Board, holding that the latter had correctly applied Article 7(1)(e)(ii) CTMR (judgment of 12/11/2008, T-270/06, Lego brick, EU:T:2008:483).

Following an appeal, the Court of Justice, in its ruling of 14/09/2010, C-48/09 P, ‘Lego brick’, confirmed the judgment of the General Court, holding that:

... the solution incorporated in the shape of goods examined is the technically preferable solution for the category of goods concerned. If the three-dimensional sign consisting of such a shape were registered as a trade mark, it would be difficult for the competitors of the proprietor of that mark to place on the market shapes of goods constituting a real alternative, that is to say, shapes which are not similar and which are nevertheless attractive to the consumer from a functional perspective’ (para. 60).

The fact that the shape concerned is, or has been, the subject of a claim in a registered patent or patent application constitutes *prima facie* evidence that those aspects of the shape identified as being functional in the patent claim are necessary to achieve a technical result (this approach has been followed by the Boards of Appeal, for example, in their decision of 17/10/2013, R 0042/2013-1).

A case regarding the following shape for ‘knives and knife handles’ provides an example of how to identify the essential characteristics of a shape and how to assess if all of those characteristics perform a technical function:

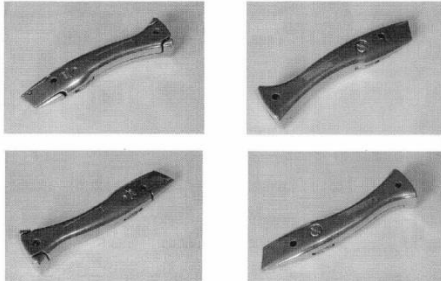
Sign	Case
	<p>Judgment of 19/09/2012, T-164/11, ‘Shape of knife handles’</p>

In this case, the shape applied for was described as

... a slightly curved knife handle characterised by a small angle of 5 to 10 degrees between the knife blade and the longitudinal axis of the shell grip, which has a middle section with a somewhat rounded outer cross section,

which broadens towards a tapered rear end. The handle also incorporates a knurled screw in the shell of the knife.

The Court stated that

As is apparent from that patent [relied upon by the invalidity applicant], the technical effect of the angle between the knife blade and the longitudinal axis of the mother-of-pearl handle is to facilitate cutting. The intermediate section is of particular importance for long cuts. It makes the cut more precise while allowing greater pressure to be exerted. Finally, the knurled screw allows the shell to be opened and the blades of the knife to be changed without using other tools and without hindering manipulation of the knife during use (para. 30).

and concluded that the most important elements of the sign, constituting its essential characteristics, are all exclusively functional (para. 33).

2.5.4 Shape that gives substantial value to the goods

Under Article 7(1)(e)(iii) CTMR, signs that consist exclusively of the shape that gives substantial value to the goods cannot be registered, or if registered they are liable to be declared invalid.

Whereas the same shape can, in principle, be protected both as a design and as a trade mark, Article 7(1)(e)(iii) CTMR only refuses trade mark protection for shapes in certain specific cases, namely, when the sign consists exclusively of a shape that gives substantial value to the product.

The concept of 'value' should be interpreted not only in commercial (economic) terms, but also in terms of 'attractiveness', that is to say, the likelihood that the goods will be purchased *primarily because of* their particular shape. When other characteristics may give the product significant value in addition to this aesthetic value, such as functional value (for instance safety, comfort and reliability), Article 7(1)(e)(iii) CTMR cannot be ruled out automatically. Indeed, the concept of 'value' cannot be limited purely to the shape of products having only artistic or ornamental value (judgment of 18/09/2014, C-205/13, Hauck, EU:C:2014:2233, § 29-32).

The concept of 'value' should not be interpreted as meaning 'reputation', since application of this absolute ground for refusal is justified exclusively by the effect on the value added to the goods *by the shape* and not by other factors, such as the reputation of the word mark that is also used to identify the goods in question (see in this regard, decision of 16/01/2013, R 2520/2011-5, § 19).

Furthermore, the fact that the shape may be **pleasing or attractive** is not sufficient to exclude it from registration. If that were the case, it would be virtually impossible to imagine any trade mark of a shape, given that in modern business there is no product of industrial utility that has not been the subject of study, research and industrial design before its eventual launch on the market (decision of 03/05/2000, R 0395/1999-3, Gancino quadrato singolo, § 1-2 and 22-36).

In assessing the value of the goods, account may be taken of **criteria** such as the nature of the category of goods concerned, the artistic value of the shape in question, its dissimilarity from other shapes in common use on the market concerned, a

substantial price difference compared with similar products, and the development of a promotion strategy that focuses on accentuating the aesthetic characteristics of the product in question (judgment of 18/09/2014, C-205/13, Hauck, EU:C:2014:2233, § 35).

For the examination of these trade marks, a **case-by-case approach is necessary**. In most of these cases a proper examination will only be possible where there is evidence that the aesthetic value of the shape can, in its own right, determine the commercial value of the product and the consumer's choice to a large extent.

If a shape derives its appeal from the fame of its designers and/or marketing efforts rather than from the aesthetic value of the shape itself, Article 7(1)(e)(iii) CTMR will not apply (decision of 14/12/2010, R 0486/2010-2, SHAPE OF CHAIR, § 20-21).

A leading case when it comes to shapes bestowing substantial value on the goods concerns the three-dimensional representation below of a loudspeaker.

Sign	Case	Goods
	<p>Decision of 10/09/2008, R 0497/2005-1</p> <p>Judgment of 06/10/2011, T-508/08</p> <p>'Representation of a loudspeaker'</p>	<p>Apart from loudspeakers, other apparatus for the reception, processing, reproduction, regulation or distribution of sound signals in Class 9 as well as music furniture in Class 20.</p>

The General Court confirmed the Board of Appeal's finding that the sign at issue fell within the scope of Article 7(1)(e)(iii) CTMR (judgment of 06/10/2011, T-508/08, Loudspeaker, EU:T:2011:575).

The General Court held that for goods such as those listed above, the design was an element that would be very important in the consumer's choice even if the consumer took other characteristics of the goods at issue into account. After having stated that the shape for which registration was sought revealed a very specific design and that it was an essential element of the applicant's branding, which increased the appeal of the product and, therefore, its value, the General Court also noted that it was apparent from the evidence on record, namely extracts from the distributors' websites and online auction or second-hand websites, that the aesthetic characteristics of that shape were emphasised first and that the shape was perceived as a kind of pure, slender, timeless sculpture for music reproduction, which made it an important selling point (judgment of 06/10/2011, T-508/08, Loudspeaker, EU:T:2011:575, § 75). The General Court thus concluded that, independently of the other characteristics of the goods at issue, the shape for which registration was sought bestowed substantial value on the goods concerned.

It follows from the above judgment that it is important to determine whether the aesthetic value of a shape can, in its own right, determine the commercial value of the product and the consumer's choice to a large extent. It is immaterial whether the overall value of the product is also affected by other factors, if the value contributed by the shape itself is substantial.

2.6 Acquired distinctiveness

2.6.1 Introduction

In accordance with Article 7(3) CTMR, a trade mark may still be registered despite the fact that it does not comply with Article 7(1)(b), (c) or (d) CTMR, provided that it 'has become distinctive in relation to the goods or services for which registration is requested in consequence of the use which has been made of it'.

Article 7(3) CTMR constitutes an exception to the rule laid down in Articles 7(1)(b), (c) or (d) CTMR, whereby registration must be refused for trade marks that are per se devoid of any distinctive character, for descriptive marks, and for marks that consist exclusively of indications that have become customary in the current language or in the bona fide and established practices of the trade.

Distinctive character acquired through use means that although the sign *ab initio* lacks inherent distinctiveness with regard to the goods and services claimed, owing to the use made of it on the market, the relevant public has come to see it as identifying the goods and services claimed in the CTM application as originating from a particular undertaking. Thus, the sign has become capable of distinguishing goods and services from those of other undertakings because they are perceived as originating from a particular undertaking. In this way, a sign originally unable to be registered under Article 7(1)(b), (c) or (d) CTMR can acquire a new significance, and its connotation, no longer purely descriptive or non-distinctive, permits it to overcome those absolute grounds for refusal of registration as a trade mark.

2.6.2 Request

The Office will only examine acquired distinctive character following a request from the CTM applicant. This request may be filed at any time during the examination proceedings. The Office is not bound to examine facts showing that the mark claimed has become distinctive through use within the meaning of Article 7(3) CTMR unless the applicant has pleaded them (judgment of 12/12/2002, T-247/01, Ecopy, EU:T:2002:319, § 47).

2.6.3 The point in time

The evidence must prove that distinctiveness through use was acquired prior to the CTMA's filing date. In the case of an IR, the relevant date is the date of registration by the International Bureau or, if the designation takes place at a later stage, the designation date. Where priority is claimed, the relevant date is the priority date. Hereafter, all these dates are referred to as the 'filing date'.

2.6.3.1 Examination proceedings

Since a trade mark enjoys protection as of its filing date, and since the filing date of the application for registration determines the priority of one mark over another, a trade mark must be registrable on that date. Consequently, the applicant must prove that distinctive character has been acquired through use of the trade mark prior to the date

of application for registration (judgments of 11/06/2009, C-542/07 P, Pure Digital, EU:C:2009:362, § 49 and 51; and 07/09/2006, C-108/05, Europol, EU:C:2006:530, § 22). Evidence of use made of the trade mark after this date should not be automatically disregarded, to the extent that it may provide indicative information regarding the situation prior to the date of application (judgment of 28/10/2009, T-137/08, Green/Yellow, EU:T:2009:417, § 49).

2.6.3.2 Cancellation Proceedings

In cancellation proceedings, a trade mark that was registered in breach of the provisions of Article 7(1)(b), (c) or (d) CTMR may nevertheless no longer be declared invalid if, in consequence of the use that has been made of it, it has, after registration, acquired distinctive character for the goods or services for which it is registered (Article 52(2) CTMR).

The precise purpose of this norm is to maintain the registration of those marks that, due to the use that has been made of them, have in the meantime — that is to say, after their registration and in any event before the application for an invalidity request — acquired distinctive character for the goods or services for which they were registered, in spite of the fact that, when registration took place, it was contrary to Article 7 CTMR (judgments of 14/12/2011, T-237/10, Clasp lock, EU:T:2011:741, § 52, 53 and 86; 15/10/2008, T-405/05, Manpower, EU:T:2008:442, § 127, 146; 10/12/2008 T-365/06, Bateaux Mouches, EU:T:2008:559, § 37 and 38).

2.6.4 Consumer

Distinctive character of a sign, including that acquired through use must be assessed in relation to the presumed perception of the average consumer for the category of goods or services in question. These consumers are deemed to be reasonably well informed, and reasonably observant and circumspect. The definition of the relevant public is linked to an examination of the intended purchasers of the goods or services concerned, since it is in relation to those purchasers that the mark must perform its essential function. Consequently, such a definition must be arrived at by reference to the essential function of a trade mark, namely to guarantee the identity of the origin of the goods or services covered by the mark to consumers or end users by enabling them, without any possibility of confusion, to distinguish the goods or services from others of another origin (judgment of 29/09/2010, T-378/07, RED/BLACK/GREY (Surface of a tractor), EU:T:2010:413, § 33, 38).

The relevant consumer includes, therefore, not only persons who have actually purchased the goods and services but also any potentially interested person in the strict sense of prospective purchasers (judgment of 29/09/2010, T-378/07, RED/BLACK/GREY (Surface of a tractor), EU:T:2010:413, § 41 et seq.).

Prospective purchasers are defined by the precise product or service for which registration is sought. If the claimed goods or services are broad (for example, bags or watches), it is irrelevant that the actual products offered under the sign are extremely expensive luxury items — the public will include all the prospective purchasers for the goods claimed in the CTMA, including non-luxury and cheaper items if the claim is for the broad category.

2.6.5 Goods and Services

Since one of the main functions of a trade mark is to guarantee the origin of goods and services, acquired distinctiveness must be assessed in respect of the goods and services at issue. Consequently, the applicant's evidence must prove a link between the sign and the goods and services for which the sign is applied for, establishing that the relevant class of persons, or at least a significant proportion thereof, identify goods as originating from a particular undertaking because of the trade mark (judgments of 04/05/1999, C-108/97 & C-109/97, Chiemsee, EU:C:1999:230, § 52; and 19/05/2009, T-211/06, Cybercredit et al., EU:T:2009:160, § 51).

2.6.6 Territorial Aspects

Pursuant to Article 1 CTMR, a Community trade mark has a unitary character and has equal effect throughout the European Union. Article 7(2) CTMR provides that a trade mark must be refused registration if an absolute ground exists only in part of the European Union.

As a logical consequence, acquired distinctiveness must be established throughout the territory in which the trade mark did not, *ab initio*, have such character (judgments of 22/06/2006, C-25/05 P, Bonbonverpackung, EU:C:2006:422, § 83, 86; and 29/09/2010, T-378/07, RED/BLACK/GREY (Surface of a tractor), EU:T:2010:413, § 30). Evidence from Non-EU states is irrelevant, except insofar as it might enable conclusions to be drawn about use within the EU (judgment of 24/07/2014, T-273/12, Ab in den Urlaub, EU:T:2014:568, § 45).

This is because the unitary character of the Community trade mark requires a sign to possess distinctive character, inherent or acquired through use, throughout the European Union (judgment of 17/05/2011, T-7/10, 'υγεία', EU:T:2011:221, § 40). It would be paradoxical to accept, on the one hand, pursuant to Article 3(1)(b) TMD, that a Member State refuses to register as a national mark a sign that is devoid of any distinctive character in its territory and, on the other, that the same Member State has to respect a Community trade mark relating to that sign for the sole reason that it has acquired distinctive character in the territory of another Member State (judgment of 14/12/2011, T-237/10, Clasp lock, EU:T:2011, § 100).

Examples:

Evidence of acquired distinctiveness of the word mark 'PHOTOS.COM' in **four Member States** (DK, FI, SE and UK) was considered **insufficient** to draw valid conclusions with regard to acquired distinctiveness in a substantial part of the territory of the European Union (judgment of 21/10/2012, T-338/11, Photos/com, EU:T:2012:614, § 49).

Evidence of acquired distinctiveness of a 'shape of two packaged goblets' relating to **eight Member States** (BE, DE, FR, IT, NL, AT, SE and UK) was considered **insufficient** to draw valid conclusions with regard to acquired distinctiveness in a substantial part of the European Union (decision of 26/07/2012, R 1301/2011-1, shape of goblets, § 62, application dismissed in T-474/12, on other grounds).

2.6.6.1 Special provisions with respect to the accession of new Member States

In accordance with the provisions of the EU Accession Treaties, a CTM applied for before the date of accession of a given Member State may only be rejected for reasons that already existed before the date of accession. Hence, in the Office's examination proceedings, acquired distinctiveness must be demonstrated only with respect to Member States of the EU at the time of the CTM application, and not those that have joined the EU subsequently.

2.6.6.2 3D marks, colours per se and figurative trade marks

If the objection exists throughout the European Union, as is normally the case for 3D marks, colours per se and figurative trade marks consisting exclusively of the depiction of the goods in question, acquired distinctiveness must be proven throughout the entire European Union (judgment of 25/09/2014, T-474/12, Shape of goblets, EU:T:2014:813, § 58). For the possibility of extrapolating the evidence, see paragraph 2.6.6.4 below.

2.6.6.3 Language area

Where the CTM applied for is rejected with respect to its meaning in a specific language, acquired distinctiveness through use must be shown with respect to the Member States in which that language is an official language.

Particular care should be taken when a language is an official language in more than one EU Member State. In such cases, when dealing with an absolute grounds objection based on the meaning of wording in a certain language, acquired distinctiveness through use must be proven for each of the Member States where that language is official (as well as any other Member States or markets where it will be understood).

(a) Examples of languages being official languages in more than one EU Member State

Language	Official language in the following Member States
German	Germany, Austria, Luxembourg and Belgium
Greek	Greece and Cyprus
English	United Kingdom, Ireland, Malta
French	France, Belgium, Luxembourg
Dutch	Netherlands and Belgium
Swedish	Sweden and Finland (judgment of 09/07/2014, T-520/12 Giffjar, EU:T:2014:620, upholding the decision of the Second Board of Appeal from 18/09/2012, R 0046/12-2, Giffjar)

Any claim that acquired distinctiveness through use enables the CTMA to overcome an absolute grounds objection that is based on its meaning in any of the above languages must automatically be examined for all the countries where the language in question is an official one.

- (b) Understanding of a Member State language in Member States where it is not an official language

In addition to the Member States where the language of a sign's wording is an official language, consideration must also be given to other Member States where it is not an official language but is understood. This may be because, depending on the goods and services claimed in the CTMA, the relevant public in that Member State has an elementary understanding of the language in question, or because the relevant public consists of specialists for whom certain technical terms in another EU Member State's official language are understood. If so, then acquired distinctiveness must be proven for the relevant public in these other EU Member States as well as in the Member States where the language is an official one.

By way of example, the GC has held that a very large proportion of European consumers and professionals have an elementary knowledge of English (judgment of 26/09/2012, T-301/09, Citigate, EU:T:2012:473, § 41). Accordingly, depending on the relevant consumer of the goods and services in question and whether the sign consists of an elementary English word or not, acquired distinctiveness may also have to be assessed with respect to further Member States.

Moving from the general public to a more specialist public for goods and services, the GC has held that certain English terms in the medical field (judgment of 29/03/2012, T-242/11, 3D eXam, EU:T:2012:179, § 26), in technical fields (judgment of 09/03/2012, T-172/10, Base-seal, EU:T:2012:119, § 54) and in financial matters (judgment of 26/09/2012, T-301/09, Citigate, EU:T:2012:473, § 41) will be understood by the relevant professionals throughout the European Union, as English is the commonly used professional language in these areas.

On the other hand, since the understanding of languages is not strictly limited by geographical borders, it may well be that, for historical, cultural or cross-border market reasons, certain (usually elementary) vocabulary of a given language may spread and could be widely understood by the general public in other Member States, particularly those with contiguous land borders. By way of example, German and French are commonly used in the Italian regions of Trentino-Alto Adige and Valle d'Aosta, while Denmark has a substantial German-speaking minority (judgment of 24/06/2014, T- 273/12, Ab in den Urlaub, EU:T:2014:568, § 44).

2.6.6.4 Extrapolation

As indicated above, the acquisition of distinctive character through use must be proven for the part of the European Union in which the trade mark concerned did not **initially** have such character. This may prove difficult and burdensome for the applicant, particularly with regard to three-dimensional or colour marks, where consumer perception of a potential lack of inherent distinctiveness will most likely be the same in each and every Member State of the European Union.

In this respect, the Court has held that, despite the fact that acquired distinctiveness must be shown **throughout the European Union**, it would be unreasonable to require proof of acquired distinctiveness for **each individual Member State** (judgment of 24/05/2012, C-98/11 P, 'Hase', EU:C:2012:307, § 62). This principle implies that, if one considers the European territory as a puzzle, failure to prove acquired distinctiveness for one or more specific national markets may not be decisive provided that the 'missing piece' of the puzzle does not affect the general picture that a significant

proportion of the relevant European public perceives the sign as a trade mark in the various parts or regions of the European Union.

In this context the question arises whether the Office can extrapolate from selective evidence to draw broader conclusions. This concerns the extent to which evidence showing distinctiveness acquired through use in certain Member States can be used to make inferences with regard to the market situation in other Member States not covered by the evidence.

Extrapolating in this way to make broader inferences is of particular relevance to an enlarged European Union comprising many Member States, since it is highly likely that a party will not be able to provide evidence with respect to the whole European Union, but will rather tend to concentrate on some areas.

Extrapolation is possible where the following two conditions are met.

- **The market is homogenous** (i.e. the area where acquired distinctiveness is proven and the area where evidence is extrapolated): market conditions and consumer habits have to be comparable. Consequently, it is particularly important that the applicant submits data concerning the size of the market, its own market share and, if possible, that of its main competitors, as well as its marketing expenses. Only if all data is comparable, may the Office extrapolate the results from one territory to another.
- **At least some evidence of use is submitted for the area where the evidence is** extrapolated. Therefore, where the CTM is used in the entire relevant territory but most of the evidence only refers to part of it, inference is possible if the circumstances are comparable and some evidence of use in another part/other parts of the relevant territory is submitted.

Evidence of acquired distinctiveness for the ‘combination of the colours green and yellow’ throughout the European Union was **accepted** despite a **lack of evidence** with regard to current turnover figures and no official statements on the relevant public’s perception for **two Member States** (judgment of 28/10/2009, T-137/08, Green/Yellow, EU:T:2009:417, § 38 et seq.)

On the other hand, the GC rejected the claim of acquired distinctiveness for a ‘chequerboard pattern’ because the applicant had not provided any relevant evidence in **4** out of the then 15 relevant Member States, without examining the evidence filed for the other 11 Member States (judgment of 21/04/2015, T-359/12, Device of a chequered pattern (maroon & beige), EU:T:2015:215, § 101 et seq., not yet final).

Finally, the Court has held that the case-law relating to Article 7(3) CTMR must not be confused with the case-law relating to the acquisition of reputation (which must be shown in a substantial part of the European Union and not in every Member State). The applicant must prove the acquisition of distinctive character through use in the part of the European Union in which the contested mark was devoid of any distinctive character. The case-law related to Article 7(3) CTMR must therefore not be confused with the test on acquisition of reputation (judgment of 21/04/2015, T-359/12, Device of a chequered pattern (maroon & beige), EU:T:2015:215, § 119-120 and case-law quoted therein, not yet final).

2.6.7 Standard of proof

The requirements to prove acquired distinctiveness through use pursuant to Article 7(3) CTMR are not the same as those to prove genuine use pursuant to Article 42(2) CTMR. Whilst under Article 7(3) CTMR it is necessary to prove qualified use, such that the relevant public perceives as distinctive a sign that per se is devoid of distinctive character, the reason behind the proof of genuine use is completely different, namely to restrict the number of trade marks registered and protected, and consequently the number of conflicts between them.

Therefore, the CTM applicant must submit evidence that enables the Office to find that at least a significant proportion of the relevant section of the public identifies the products or services concerned as originating from a particular undertaking because of the trade mark (judgment of 15/12/2015, T-262/04, Briquet Pierre, EU:T:2005:463, § 61 and the case-law cited therein).

The evidence must be clear and convincing. The CTM applicant must clearly establish all the facts necessary to safely conclude that the mark has been used as a badge of origin, that is to say, that it has created a link in the mind of the relevant public with the goods or services provided by a specific company, despite the fact that, in the absence of such use, the sign at issue would lack the necessary distinctiveness to create such a link.

For example, the combination of the colours green and yellow was found to have acquired distinctiveness through use because it referred to the machines manufactured by a certain company. The means of evidence were a number of statements from professional associations according to which such combination referred to agricultural machines manufactured by that company and the fact that such company had been using the same combination of colours on its machines consistently in the European Union for a considerable time prior to 1996 (judgment of 28/10/2009 T-137/08, Green/Yellow, EU:T:2009:417, § 36-37).

Therefore, acquired distinctiveness must be the result of the use of the mark as a trade mark, not as purely functional packaging (judgment of 25/09/2014, T-474/12, Shape of goblets, EU:T:2014:813, § 56-58 and the case-law cited therein) or as a descriptive indication on packaging. For example, use of the sign 'Gifflar' (which indicates a kind of bread in Swedish) on the packaging of pastries, together with descriptive indications of flavours, is made in a descriptive context, not as a badge of origin (judgment of 09/07/2014, T-520/12, Gifflar, EU:T:2014:620, § 44-45).

For a finding of acquired distinctiveness through use, the case-law does not prescribe fixed percentages of market penetration or of recognition by the relevant public (judgment of 19/06/2014, C-217/13 and C-218/13, Oberbank & Banco Santander, EU:C:2014:2012, § 48). Rather than using a fixed percentage of the relevant public in a given market, the evidence should show that a significant proportion of the public perceives the mark as identifying specific goods or services from a particular undertaking.

The evidence must relate to each of the goods and services claimed in the CTM application. After an initial absolute grounds objection under Article 7(1)(b), (c) or (d) CTMR, only the goods and services claimed for which acquired distinctiveness through use has been proven may proceed to registration.

2.6.8 Assessment of the evidence

In establishing acquired distinctiveness, account may be taken of, inter alia, the following **factors**:

- the market share held by the mark with regard to the relevant goods or services;
- how intensive, geographically widespread and long-standing use of the mark has been;
- the amount invested by the undertaking in promoting the mark for the relevant goods or services;
- the proportion of the relevant public who, because of the mark, identifies the goods or services as originating from a particular undertaking.

See judgments of 04/05/1999, C-108/97 & C-109/97, Chiemsee, EU:C:1999:230, § 31; and 29/09/2010, T-378/07, 'RED/BLACK/GREY (Surface of a tractor)', § 32.

Article 78 CTMR contains a non-exhaustive list of **means of giving or obtaining evidence** in proceedings before the Office, which may serve as guidance to applicants. Examples of evidence that may help to show acquired distinctiveness include, inter alia:

- sales brochures
- catalogues
- price lists
- invoices
- annual reports
- turnover figures
- advertising investment figures and reports
- advertisements (press cuttings, billboard posters, TV adverts) together with evidence of their intensity and reach

customer and/or market surveys

- affidavits.

For further details on means of evidence, see by analogy the Guidelines, Part C, Opposition, Section 5, Trade Marks with Reputation (Article 8(5) CTMR), paragraph 3.1.4.4.

The basic rules on the **evaluation of evidence** are also applicable here. The Office must make an **overall assessment of all the evidence** submitted (judgment of 04/05/1999, C-108/97 & C-109/97, Chiemsee, EU:C:1999:230, § 49), weighing up each indication against the others.

Applicants should take great care to make sure not only that the evidence shows use of the mark applied for but also that it is sufficient to identify the dates of such use and the specific geographical territory of use within the EU. Evidence that cannot be related to a certain point in time will normally be insufficient to show that distinctiveness had been acquired before the filing date, and evidence of use outside the EU cannot show the required market recognition of the relevant public within the EU. Furthermore, evidence that mixes material relating to EU with that relating to non-EU territories, and does not

permit the Office to identify the specific extent of EU-only use will be similarly devoid of probative value for the relevant EU public.

The General Court has declared that direct evidence such as declarations by professional associations and market studies are usually the most relevant means for proving acquired distinctiveness through use. Invoices, advertising expenditure, magazines and catalogues may help to corroborate such direct evidence (judgment of 29/01/13, T-25/11, Cortadora de cerámica, EU:T:2013:40, § 74).

In order to assess the evidential value of a document, regard should be had to its credibility. It is also necessary to take into account the person from whom the document originates, the circumstances in which it came into being, the person to whom it was addressed and whether, superficially, the document appears sound and reliable (judgments of 07/06/2005, T-303/03, Salvita, EU:T:2005:200, § 42; and 16/12/2008, T-86/07, DEITECH, EU:T:2008:577, § 46 et seq.).

2.6.8.1 Opinion polls and surveys

Opinion polls concerning the level of recognition of the trade mark by the relevant public on the market in question can, if conducted properly, constitute one of the most direct kinds of evidence, since they can show the actual perception of the relevant public. However, it is not an easy matter to correctly formulate and implement an opinion poll so that it can be seen to be truly neutral and representative. Leading questions, unrepresentative samples of the public, and undue editing of responses should be avoided, as these can undermine the probative value of such surveys.

Accordingly, any opinion poll evidence must be assessed carefully. It is important that the questions asked are not leading ones (judgment of 13/09/12, Case T-72/11, Espetec, EU:T:2012:424, § 79). The criteria for selecting the public interviewed must be assessed carefully. The sample must be indicative of the entire relevant public and must be selected randomly (judgment of 29/1/13, T-25/11, Cortadora de cerámica, EU:T:2013:40, § 88).

The Court does not exclude that a survey compiled some time before or after the filing date could contain useful indications, although it is clear that its evidential value is likely to vary depending on whether the period covered is close to or distant from the filing date or priority date of the trade mark application at issue. Furthermore, its evidential value depends on the survey method used (judgment of 12/07/2006, T-277/04, Vitacoat, EU:T:2006:202, § 38-39).

However, the Court of Justice has made it clear that the results of a consumer survey cannot be the only decisive criterion in support of the conclusion that distinctive character has been acquired through use (judgment of 19/06/2014, C-217/13 and C-218/13, Oberbank & Banco Santander, EU:C:2014:2012, § 48). They must therefore be complemented by other means of evidence.

For further details on the assessment of opinion polls, see the Guidelines, Part C, Opposition, Section 5, Trade Marks with Reputation Article 8(5) CTMR, paragraph 3.1.4.4.

2.6.8.2 Market share, advertising and turnover

The market share held by the trade mark in relation to the goods and/or services applied for may be relevant for assessing whether that mark has acquired distinctive character through use, since such market penetration might enable the Office to infer that the relevant public would recognise the mark as identifying the goods or services as originating from a specific undertaking, and thus distinguishing them from the goods and services of other undertakings.

The **investment** in advertising or promoting the mark in the relevant market for the goods or services claimed may also be relevant for assessing whether the mark has acquired distinctive character through use (judgment of 22/06/2006, C-25/05 P, Bonbonverpackung, EU:C:2006:422, § 76 et seq.). However, many attempts to prove distinctiveness acquired through use fail because the evidence provided by the applicant is not sufficient to prove a link between the market share and advertising, on the one hand, and consumer perceptions on the other.

Information concerning turnover and advertising expenses is one of the most readily available forms of evidence. These figures can have a significant impact on the assessment of the evidence, but in the great majority of cases are not sufficient alone to prove acquired distinctiveness of a trade mark through use. This is because turnover/advertising costs alone, without additional corroborative details, are frequently too general to allow specific conclusions to be drawn about the use of one particular trade mark. It is thus necessary to identify with precision the turnover/advertising figures and evidence relating to the mark applied for, as well as their link to the relevant goods and services. Furthermore, it is desirable that the figures be segregated on an annual and market-by-market basis. The evidence should show the specific period(s) of use (including details of when use commenced), so that the Office is able to establish whether the evidence proves that the trade mark acquired distinctiveness before the filing date.

Goods and services are often marketed under several trade marks, which makes it difficult to see the relevant customer's perception of the CTM applied for on its own, that is to say, without such perception being affected by the other marks present. Turnover and advertising figures can often include sales or promotion of other trade marks, or of significantly different forms of the trade mark at issue (for example, figurative trade marks rather than word marks, or differing word elements in a figurative mark), or are too general to allow identification of the specific markets under consideration. As a consequence, broadly consolidated turnover or advertising figures may not be sufficient to prove whether the relevant public perceives the trade mark at issue as a badge of origin or not.

For further details on the assessment of market share, advertising and turnover, see the Guidelines, Part C, Opposition, Section 5, Trade Marks with Reputation Article 8(5) CTMR, paragraph 3.1.4.4.

2.6.8.3 Declarations, affidavits and written statements

Pursuant to Article 78(1)(f) CTMR, 'statements in writing, sworn or affirmed or having a similar effect under the law of the State in which [they are] drawn up', are valid means of evidence. With regard to **admissibility**, it is necessary only in cases where the statements have not been sworn or affirmed to consider the rules of law of the national jurisdiction as to the effects of a written statement (judgment of 07/06/2005, T-303/03,

SALVITA, EU:T:2005:200, § 40). In case of doubt as to whether a statement has been sworn or affirmed, it is up to the applicant to submit evidence in this regard.

The weight and **probative value** of statutory declarations is determined by the general rules applied by the Office to the assessment of such evidence. In particular, both the capacity of the person giving the evidence and the relevance of the contents of the statement to the particular case must be taken into account.

Statements from independent trade associations, consumer organisations and competitors are an important means of evidence insofar as they come from independent sources. However, they must be examined carefully, as they might not be enough to prove distinctiveness acquired through use if, for example, they refer to 'the trade marks of the applicant' instead of to the specific mark in question (judgment of 13/09/12, Case T-72/11, Espetec, EU:T:2012:424, § 83-84).

Evidence from suppliers or distributors should, generally, be given less weight, since it is less likely that their evidence will be from an independent perspective. In this regard, the degree of independence of the latter will influence the weight to be given to the evidence by the Office (judgment of 28/10/2009 T-137/08, Green/Yellow, EU:T:2009:417, § 54-56).

Insofar as a declaration is **not made by an independent third party**, but by a person connected to the applicant through an employment relationship, it cannot in itself constitute sufficient evidence that the mark applied for has acquired distinctive character through use. In consequence, it must be treated as merely indicative and needs to be corroborated by other evidence (judgment of 21/11/2012 T-338/11, Photos/com, EU:T:2012:614, § 51)

For further details on the assessment of opinion polls, see the Guidelines, Part C, Opposition, Section 5, Trade Marks with Reputation Article 8(5) CTMR, paragraph 3.1.4.4.

2.6.8.4 Prior registrations on acquired distinctiveness

For evidence that consists of or includes Member State registrations **obtained on the basis of acquired distinctiveness**, the date to which the evidence filed at national level refers will usually be different from the filing date of the CTM application. These registrations are not binding, but may be taken into account, provided that the Office is able to assess the evidence submitted to the national IP office in question.

The applicant may also refer to **prior national registrations** where no acquired distinctiveness is claimed. Nevertheless, it is established case-law that such registrations do not bind the Office. Moreover, the Office is not bound by its previous decisions and such cases must be assessed on their own merits (judgment of 21/5/2014, T-553/12, EU:T:2014:264, Bateaux-Mouches, EU:T:2014:264, § 72 and 73).

2.6.8.5 Other means of evidence

Other means of evidence include **statements from chambers of commerce and industry or other trade and professional associations and certifications and awards**. The Court has noted that such statements and certifications must identify

precisely the trade mark applied for (judgment of 13/09/2012, T-72/11, 'Espetec', EU:T:2012:424, § 82 et seq.).

See further details on other means of evidence in the Guidelines, Part C, Opposition, Section 5, Trade Marks with Reputation (Article 8(5) CTMR), paragraph 3.1.4.4.

However, **cease and desist letters** against competitors or letters to newspapers complaining against the use of the sign in a generic sense have been considered evidence against acquired distinctiveness (judgment of 21/5/2014, T-553/12, Bateaux-Mouches, EU:T:2014:264, § 66)

2.6.8.6 Manner of use

Acquired distinctiveness must be demonstrated with respect to the sign applied for. The evidence should show examples of how the trade mark is actually used (brochures, packaging, samples of the goods, etc.). Use of a substantially different trade mark should not be given any weight. However, in accordance with Article 15(1)(a) CTMR, minor amendments to the sign that do not alter its distinctive character may be allowed (decisions of 15/01/2010, R 0735/2009-2, PLAYNOW; and 09/02/2010, R 1291/2009-2, EUROFLORIST).

It is possible to prove acquired distinctiveness of a sign that has been used together with other trade marks (judgment of 28/10/2009, T-137/08, Green/Yellow, EU:T:2009:417, § 27), provided that the relevant consumer attributes to the sign in question the function of identification (judgments of 07/07/2005, C-353/03, Have a break, EU:C:2005:432; 30/09/2009, T-75/08, '!' (fig.), EU:T:2009:374, § 43; and 28/10/2009, T-137/08, Green/Yellow, EU:T:2009:417, § 46). For instance, the Court considered that the use of the sign 'Giffjar' (which indicates a kind of bread in Swedish) on the packaging of pastries, together with the trade mark Pågen, was made in a descriptive context, not as a badge of origin (judgment of 09/07/2014, T-520/12, Giffjar, EU:T:2014:620, § 44-45).

2.6.8.7 Length of use

The evidence should indicate when use commenced and should also show that the use was continuous or indicate reasons if there are gaps in the period of use.

As a general rule, long-standing use is likely to be an important persuasive element in establishing acquired distinctiveness. The longer customers and potential customers have been exposed to a mark the more likely they are to have made the connection between that mark and a particular source in trade.

Considering, however, that length of use is only one of the factors to be taken into account, there may be situations where exceptions to the above rule are justified, in particular when other factors may also come into play that are capable of making up for a short length of use. For example, where products or services are the subject of a major advertising launch and/or the sign applied for is a mere variant of a sign already in long use, it may be the case that acquired distinctiveness can be achieved quite quickly.

This could be the case, for instance, where a new version of an existing and widely used computer-operating system is launched under a sign that essentially reproduces

the structure and/or contents of the trade mark applied to previous versions of the product. The trade mark for such a product would be capable of achieving widespread acquired distinctiveness within a fairly short period of time simply because all existing users will be immediately made aware that the sign applied for refers to the upgrading to the new version.

In the same vein, it is in the nature of certain major sporting, musical or cultural events that they take place at regular intervals and are known to have extremely wide appeal. These major events are anticipated by millions, and the knowledge that the event is due on a particular date precedes the formal announcement of where it will take place. This circumstance creates intense interest in the nominated location of such events and in the announcement thereof ('city/country+year' marks). It is therefore reasonable to suppose that the moment a particular event, tournament or games is announced as having been allocated to a particular city or country, it is likely to become known instantly to practically all relevant consumers with an interest in the sector concerned or to professionals in the sector. This may thereby give rise to the possibility of very rapid acquired distinctiveness of a mark concerning a forthcoming event, in particular where the sign reproduces the structure of previously used trade marks with the result that the public immediately perceives the new event as a sequel to a series of well-established events.

The assessment of such rapid acquired distinctiveness will follow the general criteria regarding, for instance, extent of use, territory, relevant date or targeted public, as well as regarding the onus on the applicant to provide evidence thereof. The only particularity refers to length of use and the possibility that, under certain circumstances, the acquisition of acquired distinctiveness may occur very rapidly, or even instantaneously. As under any other claim for acquired distinctiveness, it is for the applicant to demonstrate that the public is able to perceive the trade mark in question as a distinctive sign.

2.6.8.8 Post-filing date evidence

The evidence must show that prior to the filing date, the trade mark had acquired distinctive character through use.

However, this does not preclude the possibility that account may be taken of evidence that, although subsequent to the filing date, enables conclusions to be drawn regarding the situation as it was on the filing date (judgment of 19/06/2014, C-217/13, Oberbank & Banco Santander, EU:C:2014:2012, § 60). Therefore, evidence cannot be rejected merely because it post-dates the filing date. Accordingly, such evidence must be assessed and given due weight.

As an example, a trade mark that enjoys particularly relevant recognition on the market or a substantially relevant market share a few months after the filing date may have had acquired distinctiveness also on the filing date.

2.6.9 Consequences of Acquired Distinctiveness

A trade mark registered in accordance with Article 7(3) CTMR enjoys the same protection as any other trade mark that was found inherently registrable upon examination.

If the CTM application is accepted based on Article 7(3) CTMR, this information is published in the CTM Bulletin, using INID code 521.

***GUIDELINES FOR EXAMINATION IN THE
OFFICE FOR HARMONIZATION IN THE
INTERNAL MARKET (TRADE MARKS AND
DESIGNS) ON COMMUNITY TRADE MARKS***

PART C

OPPOSITION

SECTION 0

INTRODUCTION

Table of Contents

1	Overview of Opposition Proceedings – the difference between ‘absolute grounds’ and ‘relative grounds’ for refusal of a CTM application.....	3
2	The grounds for opposition.....	3
3	The ‘earlier rights’ upon which opposition must be based	4
4	The purpose of opposition proceedings and the most expedient way to treat them.....	5

1 Overview of Opposition Proceedings – the difference between ‘absolute grounds’ and ‘relative grounds’ for refusal of a CTM application

‘Opposition’ is a procedure that takes place before OHIM when a third party, on the basis of earlier rights it holds, requests the Office to reject a Community trade mark application (the ‘CTMA’) or international registration designating the EU.

When an opposition is filed against an international registration designating the EU, any reference in these Guidelines to CTMA must be read to cover international registrations designating the EU. Specific Guidelines have been drafted for International Marks including specificities about oppositions.

Under Council Regulation (EC) No 207/2009 of 26 February 2009 on the Community trade mark (the ‘CTMR’), an opposition must be based on rights held by the opponent in an earlier trade mark or other form of trade sign. The grounds on which an opposition may be based are called ‘relative grounds for refusal’, and the relevant provisions are found in Article 8 CTMR, which bears that title. Unlike absolute grounds for refusal, which are examined *ex-officio* by the Office (and which may take into account third parties’ observations although third parties do not become parties to the proceedings), relative grounds for refusal are *inter partes* proceedings based on likely conflict with earlier rights. Such relative grounds objections are not raised *ex officio* by the Office. The onus is therefore on the earlier right owner to be vigilant concerning the filing of CTMAs by others which could clash with such earlier rights, and to oppose conflicting marks when necessary.

When an opposition is filed within a prescribed time limit and the relevant fee has been paid, the proceedings are managed by the Office’s specialist service (the Opposition Division) and will normally include an exchange of observations from both the opponent and the applicant (the ‘parties’). After considering these observations, and if agreement has not been reached between the parties, the Opposition Division will decide (in an appealable ‘Decision’) either to reject the contested application totally or in part or to reject the opposition. If the opposition is not well founded, it will be rejected. If the CTMA is not totally rejected, and provided there are no other oppositions pending, it will proceed to registration.

2 The grounds for opposition

The grounds on which an opposition may be made are set out in Article 8 CTMR.

Article 8 CTMR enables the proprietors to base oppositions on their earlier rights to prevent the registration of CTMs in a range of situations progressing from that of absolute (i.e. double) identity both between goods and/or services and between marks (**Article 8(1)(a) CTMR**, where likelihood of confusion is presumed, and need not be proved) to that of similarity (**Article 8(1)(b) CTMR**, where there must be a likelihood of confusion) (see the Guidelines of Trade Mark Practice, Part C, Opposition, Section 2, Double Identity and Likelihood of Confusion).

Article 8(3) CTMR allows the proprietor of a mark to prevent the unauthorised filing of its mark by its agent or representative (see the Guidelines, Part C, Opposition, Section 3, Trade Mark Filed by an Agent).

Article 8(4) CTMR enables the proprietor of earlier non-registered trade marks or other signs used in the course of trade of more than mere local significance to prevent registration of a later CTMA if the proprietor has the right to prohibit the use of such CTMA. Although likelihood of confusion is not expressly mentioned in this article, the application of the relevant laws that are brought into play under Article 8(4) CTMR will frequently require an analysis of likelihood of confusion (see the Guidelines, Part C, Opposition, Section 4, Non-Registered Rights).

Article 8(5) CTMR enables the proprietors of an earlier reputed registered trade mark to prevent registration of a later CTMA that, without due cause, would encroach on the earlier reputed mark. Likelihood of confusion is not a condition for the application of this article. This is because Article 8(5) CTMR specifically (but not exclusively) protects functions and uses of trade marks that fall outside the ambit of the badge of origin protection offered by likelihood of confusion and, as such, is more directed at protecting the heightened effort and financial investment that is involved in creating and promoting trade marks to the extent that they become reputed and to facilitate full exploitation of the value of the marks (see the Guidelines, Part C, Opposition, Section 5, Trade Marks with Reputation).

3 The ‘earlier rights’ upon which opposition must be based

An opposition must be based on at least one earlier right owned by the opponent.

The meaning of ‘earlier’ rights for Article 8(1) and 8(5) CTMR is defined in **Article 8(2) CTMR**, meaning such rights having an earlier date (not hour or minute, as confirmed by the Court in its judgment of 22/03/2012, C-190/10, ‘Génesis Seguros’) of application for registration than the CTMA, including applicable claimed priority dates, or have become well known in a Member State before the CTMA or, if appropriate, its claimed priority date. See the Guidelines of Trade Mark Practice, Part C, Opposition, Section 1, Procedural Matters.

In essence, these rights consist of EU registered trade marks and applications for such, and ‘well known’ marks in the sense Article 6bis of the Paris Convention (which need not be registered). For a detailed explanation of these ‘well known’ marks under Article 8(2)(c) CTMR, and how they differ from Article 8(5) marks with reputation, see the Guidelines, Part C, Opposition, Section 5: Trade marks with reputation, paragraph 2.1.2.

Under Article 8(3) CTMR, the opponent must show that it is the proprietor of a trade mark, acquired anywhere in the world by registration or by use (to the extent that the law of the country of origin recognises this kind of trade mark right), for which an agent or representative of the proprietor has applied for registration in its own name without the proprietor’s consent.

Article 8(4) CTMR, by contrast, deals with oppositions based on earlier non-registered trade marks or on another sign used in the course of trade of more than mere local significance, in accordance with provisions of EU Member State law. The meaning of ‘earlier’ rights for Article 8(4), as regards the relevant date of acquisition, is thus defined by the relevant national law.

Various legal grounds, based on different earlier rights, may be alleged in either the same or multiple oppositions to the same CTMA.

OHIM practice is based on the legal provisions of the CTMR applied directly or by analogy, as confirmed by the case-law of the General Court (judgment of 16/09/2004, T-342/02, 'MGM' and 11/05/2006, T-194/05, 'TeleTech'). Namely:

- **Multiple oppositions:** Rule 21(2) and (3) CTMIR allows the Office to examine only the 'most effective' opposition(s), suspending the rest and eventually deeming them to have been dealt with if the application is rejected on the basis of the chosen opposition. With regards to the 'most effective' opposition, see below.
- **Multiple earlier rights in one opposition:** the Court has observed that grouping various earlier rights in one opposition is, for practical purposes, the same as presenting multiple oppositions, making it possible for the Office to base the rejection of the application on the 'most effective' right(s). With regards to the 'most effective' earlier right, see below.
- **Multiple legal grounds in opposition(s):** if the opposition is successful in its entirety on the basis of the 'most effective' legal ground(s), it is not necessary to examine the remaining legal grounds. If a necessary requirement of a legal ground is not fulfilled, it is not necessary to examine the remaining requirements of that provision. With regards to the 'most effective' legal ground(s), see below.

4 The purpose of opposition proceedings and the most expedient way to treat them

The Court of Justice has stated that the sole purpose of opposition proceedings is to decide whether the application may proceed to registration and not to pre-emptively settle potential conflicts (e.g. at a national level arising from the possible conversion of the CTMA) (judgment of 11/05/2006, T-194/05, 'TeleTech', paragraphs 25-27).

The Court of Justice has confirmed clearly that the Office is under no obligation to examine all the earlier oppositions, rights and legal grounds invoked against the same CTMA, if one of them suffices to reject the CTMA. Nor is it obliged to choose the earlier right with the widest territorial scope so as to prevent the eventual conversion of the application in as many territories as possible (judgment of 16/09/2004, T-342/02, 'MGM' and 11/05/2006, T-194/05, 'TeleTech').

This principle allows for a more expedient treatment of oppositions. The Office is free to choose what it regards as the 'most effective' opposition(s), earlier right(s) and legal ground(s) and which one to examine first in light of the principle of procedural economy.

The 'most effective' opposition can normally be defined as the opposition which allows the Office to refuse the registration of the opposed CTMA to the broadest possible extent and in the simplest manner.

The 'most effective' earlier right can normally be defined as the most similar (the closest) sign covering the broadest scope of goods and services and/or the right covering the most similar goods and services.

The 'most effective' legal ground can normally be defined as the opposition ground which presents the Office with the simplest manner of refusing the registration of the opposed CTMA to the broadest possible extent.

Generally speaking, if applicable, Article 8(1)(a) will be the simplest ground in terms of procedural economy on which to reject a CTMA, since the Office will not need to enter into an analysis of similarities and differences between the signs or goods/services, nor will a finding of likelihood of confusion be necessary. Failing that, the factual circumstances of each opposition will determine whether Article 8(1)(b), 8(3), 8(4) or 8(5) are the next 'most effective' grounds (for example, if the goods and services of the earlier right and the CTMA are different, Articles 8(1)(b) and (3) cannot serve as a valid basis of opposition, the former requiring at least some similarity in this respect, and the latter requiring at least closely related or commercially equivalent goods and services).

If evidence of use has been requested by the applicant in relation to some of the earlier rights, the Office will normally firstly consider if one earlier right not yet under the use obligation is capable of fully sustaining the opposition. If not, other earlier rights not yet under the use obligation will be examined to see if the opposition can be fully sustained on such a cumulative basis. In these cases, the CTMA will be rejected without it being necessary to consider proof of use. Only if no such earlier right(s) is (are) available, will the Office consider those earlier rights against which proof of use was requested.

***GUIDELINES FOR EXAMINATION IN THE
OFFICE FOR HARMONIZATION IN THE
INTERNAL MARKET (TRADE MARKS AND
DESIGNS) ON COMMUNITY TRADE MARKS***

PART C

OPPOSITION

SECTION 1

PROCEDURAL MATTERS

Table of Contents

1	Introduction: General Outline of Opposition Proceedings	6
2	Admissibility Check.....	7
2.1	Notice of opposition in writing	7
2.1.1	Early oppositions against an international registration	7
2.1.2	Early opposition against a CTM application	8
2.2	Payment	8
2.2.1	Notice of opposition late, payment within the opposition period	8
2.2.2	Time of payment	8
2.2.2.1	Payment by bank transfer.....	9
2.2.2.2	Payment by current account.....	9
2.2.3	Consequences in the event of non-payment.....	9
2.3	Languages and translation of the notice of opposition	10
2.3.1	Language of proceedings	10
2.3.2	Language of the notice of opposition and translations	11
2.3.3	Examples	11
2.4	Admissibility check	12
2.4.1	Absolute admissibility requirements	12
2.4.1.1	Identification of the contested CTM application	13
2.4.1.2	Identification of the earlier marks/rights	14
2.4.1.3	Identification of grounds	17
2.4.2	Relative admissibility requirements	18
2.4.2.1	Dates	18
2.4.2.2	Representation of earlier marks/signs	18
2.4.2.3	Goods and services.....	20
2.4.2.4	Earlier mark with a reputation: scope of reputation	22
2.4.2.5	Identification of the opponent	22
2.4.2.6	Professional representation.....	26
2.4.2.7	Signature	28
2.4.2.8	Relative admissibility requirements: sanctions	28
2.4.3	Optional indications	28
2.4.3.1	Extent of the opposition	28
2.4.3.2	Reasoned statement	29
2.5	Notification of the notice of opposition	29
3	Cooling-Off Period.....	30
3.1	Setting the cooling-off period in motion.....	30
3.2	Extension of the cooling-off period.....	31
4	Adversarial Stage	32
4.1	Completion of the opposition	32
4.2	Substantiation	33
4.2.1	CTMs and CTM applications	33
4.2.2	Converted CTM(A)s.....	34
4.2.2.1	Opposition based on CTM(A) (to be) converted	34
4.2.2.2	Opposition based on CTM(A) that is subsequently converted.....	34
4.2.3	Trade mark registrations or applications that are not CTMs	34
4.2.3.1	Certificates issued by the appropriate official body	35
4.2.3.2	Extracts from official databases.....	35

4.2.3.3	Extracts from official bulletins of the relevant national trade mark offices and WIPO.....	37
4.2.3.4	Duration of a trade mark registration.....	37
4.2.3.5	Verification of evidence.....	38
4.2.3.6	Renewal certificates.....	40
4.2.3.7	Entitlement to file the opposition.....	40
4.2.4	Substantiation of well-known marks, claims of reputation, trade marks filed by an agent, earlier signs used in the course of trade.....	41
4.2.4.1	Well known marks.....	41
4.2.4.2	Marks with reputation.....	42
4.2.4.3	Non-registered trade mark or another sign used in the course of trade....	42
4.2.4.4	Mark filed by an agent or representative.....	42
4.2.5	Sanction.....	43
4.3	Translation/changes of language during the opposition proceedings.	43
4.3.1	Translations of evidence of trade mark registrations and of facts, evidence and arguments submitted by the opponent to complete its file....	43
4.3.1.1	Sanction.....	45
4.3.2	Translation of further observations.....	45
4.3.3	Translation of documents other than observations.....	46
4.3.4	Proof of use.....	47
4.3.5	Change of language during opposition proceedings.....	47
4.4	Documents not readable/reference to other files.....	48
4.4.1	Documents not readable.....	48
4.4.2	No return of original documents.....	48
4.4.3	Confidential information.....	48
4.4.4	References made to documents or items of evidence in other proceedings.....	49
4.5	Further exchanges.....	50
4.5.1	Additional evidence for proof of use.....	51
4.6	Observations by third parties.....	51
5	Termination of Proceedings.....	52
5.1	Friendly settlement.....	52
5.2	Restrictions and withdrawals.....	52
5.2.1	Restrictions and withdrawals of CTM applications.....	52
5.2.1.1	Withdrawal or restriction before the admissibility check is made.....	53
5.2.1.2	Restrictions and withdrawals of CTM applications before the end of the cooling-off period.....	54
5.2.1.3	Restrictions and withdrawals of CTM applications after the end of the cooling-off period.....	55
5.2.1.4	Restrictions and withdrawals of CTM applications after a decision has been taken.....	55
5.2.1.5	Language.....	56
5.2.2	Withdrawal of oppositions.....	56
5.2.2.1	Withdrawal of the opposition before the end of the cooling-off period.....	56
5.2.2.2	Withdrawal of the opposition after the end of the cooling-off period.....	56
5.2.2.3	Withdrawal of the opposition after a decision has been taken.....	57
5.2.2.4	Language.....	57
5.2.3	Withdrawals of withdrawals/restrictions.....	57
5.3	Decision on substance.....	57
5.3.1	Earlier right not proven.....	58
5.3.2	Ceasing of existence of the earlier right.....	58
5.4	Fee refund.....	59

5.4.1	Opposition deemed not entered	59
5.4.1.1	Opposition and withdrawal of the opposition filed the same date	59
5.4.1.2	Refund after republication	59
5.4.2	Refund in view of withdrawals/restrictions of CTM application	59
5.4.2.1	CTM application withdrawn/restricted before the end of the cooling-off period	59
5.4.2.2	Opposition withdrawn due to restriction of CTM application within the cooling-off period	59
5.4.3	Multiple oppositions and refund of 50 % of the opposition fee	60
5.4.4	Cases where the opposition fee is not refunded	60
5.4.4.1	Opposition withdrawn before the end of the cooling-off period NOT due to a restriction	60
5.4.4.2	Opponent's withdrawal is earlier	60
5.4.4.3	Settlement between the parties before commencement of proceedings ...	60
5.4.4.4	Termination of proceedings for other reasons	61
5.4.4.5	Reaction on disclaimer	61
5.5	Decision on the apportionment of costs	61
5.5.1	Cases in which a decision on costs must be taken	61
5.5.2	Cases in which a decision on costs is not taken	62
5.5.2.1	Agreement on costs	62
5.5.2.2	Information from potential 'successful party'	62
5.5.3	Standard cases of decisions on costs	62
5.5.4	Cases that did not proceed to judgment	63
5.5.4.1	Multiple oppositions	63
5.5.4.2	Rejection of an application on the basis of absolute grounds or formalities	64
5.5.4.3	Cases of joinder	64
5.5.4.4	The meaning of 'bear one's own costs'	65
5.6	Fixing of costs	65
5.6.1	Amounts to be reimbursed/fixed	65
5.6.2	Procedure if the fixing of costs is contained in the main decision	66
5.6.3	Procedure if a separate fixing of costs is needed	66
5.6.3.1	Admissibility	66
5.6.3.2	Evidence	67
5.6.4	Review of fixing of costs	67
6	Procedural Issues	67
6.1	Correction of mistakes	67
6.1.1	Correction of mistakes in the notice of opposition	67
6.1.2	Correction of mistakes and errors in publications	68
6.2	Time limits	68
6.2.1	Extension of time limits in opposition proceedings	69
6.2.1.1	Non-extendable and extendable time limits	69
6.2.1.2	Request made in time	69
6.2.1.3	Extension of a time limit by the Office on its own initiative	70
6.2.1.4	Signature	70
6.3	Suspension	71
6.3.1	Suspension requested by both parties	71
6.3.2	Suspensions by the Office <i>ex officio</i> or at the request of one of the parties	71
6.3.2.1	Explanation of the basic principle, timing of suspension	72
6.3.2.2	Earlier CTM applications or registrations	73
6.3.2.3	Earlier national/international marks (applications or registrations/rights) ...	73
6.3.2.4	Examples	73
6.3.3	Multiple oppositions	74
6.3.3.1	After rejection of the CTM application	74

6.3.4	Procedural aspects.....	74
6.3.4.1	Monitoring suspended files.....	74
6.3.4.2	Resuming the proceedings.....	75
6.3.4.3	Calculation of time limits.....	75
6.4	Multiple oppositions.....	76
6.4.1	Multiple oppositions and restrictions	76
6.4.2	Multiple oppositions and decisions	76
6.4.3	Joinder of proceedings	78
6.5	Change of parties (transfer, change of name, change of representative, interruption of proceedings).....	79
6.5.1	Transfer and opposition proceedings	79
6.5.1.1	Introduction and basic principle	79
6.5.1.2	Transfer of earlier CTM	79
6.5.1.3	Transfer of earlier national registration.....	81
6.5.1.4	Opposition based on a combination of CTM registrations and national registrations.....	82
6.5.1.5	Transfer of the contested CTM application.....	82
6.5.1.6	Partial transfer of a contested CTM application.....	82
6.5.2	Parties are the same after transfer	83
6.5.3	Change of names	83
6.5.4	Change of representatives	83
6.5.5	Interruption of the proceedings due to death or legal incapacity of the applicant or its representative.....	84
6.5.5.1	Death or legal incapacity of the applicant.....	84
6.5.5.2	Applicant prevented from continuing the proceedings before the Office owing to legal reasons (e.g. bankruptcy).....	84
6.5.5.3	Death or prevention for legal reasons of the representative of the applicant before the Office to act.....	85

1 Introduction: General Outline of Opposition Proceedings

Opposition proceedings start with receipt of the notice of opposition. The applicant is notified of the notice of opposition filed and receives a copy of the documents on file.

Thereafter, once the payment of the opposition fee has been checked, the notice of opposition is checked for compliance with other formal requirements of the Regulations.

In general, two kinds of admissibility deficiencies can be distinguished:

1. *Absolute deficiencies*, i.e. deficiencies that cannot be remedied after the expiry of the opposition period. If the opponent does not remedy these deficiencies on its own initiative within the opposition period, the opposition is inadmissible.
2. *Relative deficiencies*, i.e. deficiencies that can be remedied after the expiry of the opposition period. The Office invites the opponent after the expiry of the opposition period to remedy the deficiency within a non-extendable time limit of two months, failing which the opposition will be rejected as inadmissible.

It is important to note that in order to safeguard the principle of impartiality, the Office will not send any communication concerning the payment of the opposition fee or admissibility deficiencies during the opposition period.

After the examination of admissibility of the opposition, a notification is sent to both parties to set the time limits for the proceedings. This starts with a period during which the parties are incentivised to negotiate an agreement because, if certain conditions are met, the opposition fee will be refunded — this is known as the ‘cooling-off’ period. The cooling-off period is set to expire two months from the notification of admissibility. It can be extended once by 22 months and last up to a total of 24 months.

Once the cooling-off period has expired, the adversarial part of the proceedings begins. The opponent is then allowed two more months to submit all evidence and observations it considers necessary to make its case. After these two months have lapsed, and once the submitted evidence and observations (if any) have been forwarded, the applicant has two months to reply to the opposition.

At this stage, the applicant can require the opponent to prove that any earlier marks registered for more than five years have been used by filing a request for proof of use. If such a request is made, the applicant may wait until the opponent has adduced such proof before filing its evidence and observations. The opponent is then given the opportunity to comment on the applicant’s observations.

If the applicant does not request proof of use but submits evidence and observations, the opponent is given two months to comment on the applicant’s submissions and after these exchanges the opposition is normally ready for decision.

In some cases it may be necessary or useful to have another exchange of observations. This may occur when the case deals with complex issues or when the opponent raises a new point that is admitted to the proceedings. In this case the applicant may be given a possibility of replying. It is then up to the examiner to decide if another round should be given to the opponent.

The Office may request the parties to restrict their observations to particular issues, permitting observations on other issues at a later point in time.

Once the parties have submitted their observations, the proceedings are closed, the file is ready for taking a decision on substance and the parties are informed accordingly.

When an opposition is filed against an international registration designating the EU, all references in the Guidelines to CTM applications must be read as including international registrations designating the EU. Part M of the Guidelines, International Marks, which has been drafted specifically for international marks, also refers to oppositions.

2 Admissibility Check

2.1 Notice of opposition in writing

Article 41 CTMR
Rule 16a CTMIR
Rule 82 and Decision EX-132 of the President of the Office

The notice of opposition has to be received by the Office in written form within the opposition period, namely within three months from the publication of the contested CTM application.

A notice of opposition may be filed by using the electronic form available in the User Area of the Office's website. Once submitted, the electronic form will be processed automatically and a receipt for the opponent will be issued. A notice of opposition may also be filed by fax, post or personal delivery, and in all these cases the opponent will also be sent a receipt after the notice of opposition has been keyed into the Office's IT system.

The applicant receives a copy of the notice of opposition (and of any document submitted by the opposing party) for information purposes. If the opposition is based on a Community trade mark, the applicant is also informed that it can access information about earlier Community trade marks via the online search tools, which are available on the Office's website.

2.1.1 Early oppositions against an international registration

Article 156(2) CTMR
Rule 114(3) CTMIR

Opposition against an international registration designating the EU (IR) may be filed between the sixth and the ninth month following the date of first re-publication. For example, if first re-publication is on 15/02/2013, then the opposition period starts on 16/08/2013 and ends on 15/11/2013.

However, oppositions filed after the re-publication of the IR but prior to the start of the opposition period will be kept on hold and be deemed to have been filed on the first day of the opposition period. The opponent will be informed accordingly. If the opposition is withdrawn before that date, the opposition fee will be refunded.

2.1.2 Early opposition against a CTM application

Articles 39 and 41 CTMR

Any notice of opposition against a CTM application received before commencement of the opposition period will be kept on hold and be deemed to have been filed on the first day of the opposition period, namely the first day after the publication of the CTM application in part A.1 of the CTM Bulletin. The opponent will be informed accordingly. If the opposition is withdrawn before that date or the CTM application is refused or withdrawn before publication, the opposition fee will be refunded.

2.2 Payment

For general rules on payments, refer to the Guidelines, Part A, General Rules, Section 3, Payment of Fees, Costs and Charges.

2.2.1 Notice of opposition late, payment within the opposition period

Rule 17(2) CTMIR

If the payment was received by the Office within the opposition period but the notice of opposition was received late, the opposition is inadmissible. In this case the Office will keep the opposition fee. The opponent must be notified and may comment on the finding of inadmissibility within the time limit set by the Office.

If the opponent submits convincing evidence, such as fax reports, confirmation of receipt by messenger and/or delivery slips for registered mails that proves that the notice of opposition was not late and was in fact correctly received by the Office within the three month opposition period, the Office must reconsider its finding and accept the opposition as having been received within the opposition period. In this case the admissibility check can continue. If the evidence submitted by the opponent does not prove that the notice of opposition was received within the opposition period or if the opponent does not reply within the set time limit, a decision ruling the opposition inadmissible has to be taken. When notifying the opponent of the decision, the applicant must be sent a copy.

2.2.2 Time of payment

Article 41(3) CTMR
Article 8 CTMFR
Rule 17(1) CTMIR

The Office has to receive the full amount of the opposition fee within the opposition period. If the opposition fee was not received within the opposition period, the notice of opposition is deemed not to have been entered.

2.2.2.1 Payment by bank transfer

Payments by bank transfer received after the opposition period are considered to be made within the opposition period if the opponent (i) files evidence showing that it gave the transfer order to a banking establishment within the opposition period and (ii) pays a surcharge of 10 % of the opposition fee. No surcharge will be payable if the evidence shows that the order to the bank was given no less than 10 days before the expiry of the opposition period.

2.2.2.2 Payment by current account

Articles 5(2) and 8(1) CTMFR Decision EX-06-1 of the President of the Office

If the opponent or its representative hold a current account, the payment is considered effective on the day the opposition is received.

Since a payment by current account is considered to have been made on the date of receipt of the opposition, if the notice of opposition arrived late, the payment is also late. Therefore, the opposition is deemed not to have been entered.

The absence of an indication or incorrect indication of the amount of the opposition fee does not have any negative effect on the opposition, because it is clear that the opponent wanted to pay the amount of the opposition fee.

Even if there is no express request from the opponent, the existence of a current account will in such case be sufficient for the account to be debited. This is true regardless of whether the opposition form is used or not.

The only exception to this rule is made when the holder of a current account who wishes to exclude the use of the current account for a particular fee or charge informs the Office thereof in writing (e.g. indicating bank transfer).

Fee payment by debiting a current account held by a third party

Payment of an opposition fee by debiting a current account held by a third party requires an explicit authorisation of the holder of the current account that its account can be debited for the benefit of the particular fee. In such cases the opponent must file an authorisation within the opposition period.

Payment is considered to be made on the date the Office receives the authorisation.

2.2.3 Consequences in the event of non-payment

Rule 17(1), (4) and Rule 54 CTMIR

An opposition for which the payment is not made within the opposition period will be deemed not to have been entered and the opponent must be notified of this finding.

A copy of this letter must be sent to the applicant for information purposes at the same time.

If, within the time limit allowed, the opponent submits evidence that the Office finds that the loss of rights was inaccurate, and it proves that the payment was made on time, a notification has to be sent with a copy to the applicant, together with the evidence provided by the opponent.

If an opposition is deemed not to have been entered, the opponent has the right to request a formal decision within two months. If it does so, the decision must be sent to both parties.

For cases in which the opposition fee has not been paid in full or after the opposition period, see paragraph 5.4.1 below.

2.3 Languages and translation of the notice of opposition

Article 119(5), (6) CTMR Rule 16 and Rules 17(3), 83(3) and 95(b) CTMIR
--

2.3.1 Language of proceedings

The rules regarding the language of proceedings are explained in detail in the Guidelines, Part A, General Rules, Section 4, Language of Proceedings.

According to these rules, in opposition proceedings there are cases where the opponent has a choice between two possible languages of proceedings (the first and second languages of the contested CTMA, both being languages of the Office), and cases where there is only one possible language of proceedings (when the first language is not one of the five languages of the Office, the language of the opposition proceedings will be the second language of the contested CTMA).

In cases where there is a choice, the language of proceedings will be that expressly indicated by the opponent in the notice of opposition or, in the absence of an express indication, the language in which the notice of opposition was filed, provided in both cases that it is one of the two possible languages of proceedings. If the opponent indicates a language that is incorrect, or does not indicate any language and the notice of opposition is not filed in one of the two possible languages of proceedings, the Office will send a letter to the opponent asking it to indicate the language of proceedings within a specified time limit. The letter will be sent in the first language of the contested CTMA. If no reply is received to this letter, the opposition will be rejected as inadmissible.

In cases where there is no choice, there is no need to ask the opponent to indicate a language of proceedings, so the Office will consider that the language of proceedings is the second language of the CTM application, regardless of any possible incorrect indication of a different language in the notice of opposition.

2.3.2 Language of the notice of opposition and translations

The notice of opposition is filed in one of the five languages of the Office.

If the notice of opposition is filed in a language that cannot be the language of proceedings, in accordance with what has been explained in the previous section, a distinction will be made depending on whether it has been filed using one of the official opposition forms provided by the Office or not.

1. **When the Office's official opposition form has been used**, in any of the official languages of the EU, there is no need to submit a translation of the notice of opposition as such, since when the opposition is notified, a blank form in the language of the proceedings will be annexed by the Office.

If the textual elements important for admissibility do not need to be translated (e.g. numbers, names or addresses) and all the appropriate boxes are ticked, the opposition will be admissible.

If there are some textual elements important for admissibility that need to be translated into the language of proceedings (e.g. the goods and services on which the opposition is based, see paragraph 2.4.2.3 below), the corresponding admissibility deficiency will be issued.

Finally, if there are some textual elements that are not translated but are not relevant for admissibility purposes, such as an explanation of grounds (optional indication), they will be deemed not to 'exist'. For more information see paragraph 2.4 Admissibility check below.

2. **When the Office's official opposition form has not been used:**

If the notice of opposition is in one of the languages of the Office that cannot be the language of proceedings, and in accordance with Article 119(6) CTMR and Rule 16(1) CTMIR, the opponent will on its own initiative file a translation in the language of proceedings within one month from the expiry of the opposition period. If none is received the opposition is inadmissible.

If the notice of opposition is not in one of the five languages of the Office, and in accordance with Article 119(5) CTMR, the opposition is inadmissible.

In both cases, if no language of proceedings (or an incorrect one) has been indicated in the notice of opposition, the notification of the inadmissibility will be sent in the first language of the contested CTMA if it is a language of the Office, or otherwise in the second language of the contested CTMA.

2.3.3 Examples

As an illustration of what has been explained in paragraphs 2.3.1 and 2.3.2, here are some examples:

- a) The languages of the CTM application are PT and EN. The Portuguese language version of the official form has been used, none of the textual elements relevant for admissibility need to be translated and the appropriate boxes are ticked. The opposition is admissible. As the language of proceedings can only be EN, it is not necessary to ask the opponent to indicate the language of the opposition

proceedings. When the opposition is notified a blank official form in EN must be attached, and the language of the proceedings indicated.

- b) The languages of the CTM application are DE and EN. The French language version of the official form has been used, none of the textual elements need to be translated and the appropriate boxes are ticked. As the language of proceedings can be either DE or EN, the opponent must be asked to indicate the language of the opposition proceedings. Once the opponent has indicated one of the possible languages of proceedings, the opposition will be admissible. When the opposition is notified, a blank official form in the indicated language must be attached.
- c) The languages of the CTM application are DE and EN. The notice of opposition has not been filed using the official form, it is in French and no choice of language of proceedings has been indicated. The opponent will submit on its own initiative a translation of the notice of opposition into either DE or EN within a period of one month of the expiry of the opposition period. Otherwise the opposition will be rejected as inadmissible, and the corresponding notification will be sent in DE.
- d) The languages of the CTM application are CZ and EN. The notice of opposition has not been filed using the official form and is in Czech. The opposition will be rejected as inadmissible and the corresponding notification will be sent in EN.

2.4 Admissibility check

Rules 15 and 17 CTMIR

The admissibility check covers both absolute and relative requirements:

- absolute requirements are the indications and elements that must be present in the notice of opposition or submitted by the opponent on its own initiative within the opposition period, as laid down in Rule 15(1) and Rule 15(2)(a)-(c) CTMIR;
- relative requirements are the indications and elements which, if they are not provided within the opposition period, trigger a deficiency notice by the Office, allowing the opponent to remedy this within a non-extendable time limit of two months, as laid down in Rule 15(2)(d)-(h) CTMIR;
- optional indications (that determine the scope of the opposition but do not in principle lead to a finding of non-admissibility) are laid down in Rule 15(3) CTMIR.

For the purposes of assessing the admissibility of the opposition the Office must base itself solely on the claims contained in the documents submitted by the opponent within the opposition period (decision of 21/07/2014, R 1573/2013-4, OKAY/O-Key).

2.4.1 Absolute admissibility requirements

If the opposition is inadmissible due to absolute admissibility requirements, the opponent must be informed and invited to comment on the admissibility. If the

inadmissibility is confirmed, a decision rejecting the opposition is sent and copied to the applicant.

Oppositions against CTMAs

The earlier marks/rights are examined to see if at least one is clearly identified. If the only earlier right on which the opposition is based is not duly identified, the opposition is inadmissible and the opponent is invited to comment on the inadmissibility before the decision on inadmissibility is taken. If the only earlier right on which the opposition is based is duly identified (absolute requirements), the Office will examine whether it also meets the relative admissibility requirements.

If the opposition is based on more than one earlier right and at least one of them has been correctly identified, the examination of admissibility (relative requirements) can proceed based on that earlier right. The parties are informed thereof when the notification of the time limits of the opposition proceedings is sent to the parties.

If necessary, the admissibility issue will be dealt with in the decision on the opposition.

Oppositions against IRs with EU designation

Concerning oppositions against IRs with EU designation, a full admissibility check is carried out. This check must extend to all earlier rights. If none of the earlier rights is duly identified, the opposition is inadmissible and the opponent is invited to comment on the inadmissibility before the decision on inadmissibility is taken.

2.4.1.1 Identification of the contested CTM application

Rule 15(2)(a) and Rule 17 CTMIR

The mandatory elements for identifying the contested CTM application are the application number and the name of the applicant.

If, for example, the application number indicated does not correspond to the name of the applicant indicated, the Office will decide if it can be established without any doubt which is the contested CTM application. If the applicant's name is not indicated, it can be found in the Office's IT system.

The date of publication is an optional indication, which helps to double-check the identification of the CTM application. Even if it is missing, the CTM application can be sufficiently identified through the other indications.

Only one CTM application can be contested in one notice of opposition.

If the CTM application cannot be identified, this deficiency can only be remedied on the opponent's initiative during the three-month opposition period, otherwise the opposition is inadmissible and an invitation to comment on the inadmissibility has to be sent. If the inadmissibility is confirmed, a decision rejecting the opposition is sent and copied to the applicant.

2.4.1.2 Identification of the earlier marks/rights

Article 8(2) CTMR
Rule 15(2)(b) and Rule 17(2) CTMIR

Identification elements are to be looked for not only in the notice of opposition, but also in annexes or other documents filed together with the opposition or any documents submitted within the opposition period.

An opposition can be based on five types of earlier rights: (1) earlier trade mark registrations or applications, (2) earlier trade mark registrations or applications with a reputation, (3) earlier well-known marks, (4) earlier unregistered trade marks and (5) earlier signs used in the course of trade.

Earlier rights that are not earlier

Articles 8(2) and 41(1) CTMR

For an earlier right to be earlier it must have, in the absence of any priority, an application date that is prior to the day on which the contested CTMA was filed. In the case of conflict between a national mark and a CTM application, the hour and the minute of filing of the national mark is not relevant for determining which mark is earlier (judgment of 22/03/2012, C-190/10, Rizo, EU:C:2012:157).

Sometimes an opposition is based on one or more marks or other rights that are not earlier than the CTM application. Establishing whether a right is earlier takes place at the admissibility stage.

When the only earlier mark is or all earlier marks are not earlier, the Office will inform the opponent of the inadmissibility and invite it to comment on that issue before a decision on inadmissibility is taken.

Where the opposition is based on more than one right, one being earlier and one or more not earlier, the Office will notify the admissibility of the opposition on the basis of the earlier one.

Earlier trade mark registrations or applications

Article 8(2)(a), (b) and Article 34(2) CTMR
Rule 15(2)(b) and Rules 17(2) and 19(1) and (3) CTMIR

These rights are Community trade mark registrations or applications, international registrations designating the European Union, national or Benelux trade mark registrations or applications (including 'ex Community trade marks' for which a request for conversion has been filed) and international registrations under the Madrid Agreement or Protocol having effect in a Member State.

The seniority claimed in a CTM can be taken into account within the meaning of Article 8(2)(a) CTMR provided that the proprietor of the CTM has surrendered the earlier mark or allowed it to lapse within the meaning of Article 34(2) CTMR and that this fact is proved by the opponent.

In such a case, the opponent must base its opposition on the Community trade mark, explicitly claiming within the three-month opposition period that the national mark continues to exist through the seniority claimed in the CTM. A clear link must be established between the CTM indicated and the earlier mark for which the seniority was claimed in the CTM. Within the time limit set according to Rule 19(1) CTMIR, the opponent must provide sufficient proof, emanating from the Office, that the seniority claim has been accepted and proof, emanating from the administration by which the national trade mark was registered, that the national mark has been surrendered or allowed to lapse according to Article 34(2) CTMR.

The absolute identification elements for earlier trade mark registrations and applications are:

- the registration/application number;

National applications deriving from the conversion of an earlier CTM(A) are considered to come into existence as soon as a valid conversion request is submitted. Such rights will be properly identified for admissibility purposes if the opponent indicates the number of the CTM(A) under conversion and the countries for which it has requested the conversion.

- the indication whether the earlier mark is registered or applied for;
- the Member State, including Benelux, where the earlier mark is registered/applied for or, if applicable, the indication that it is a CTM.

If the Member State is not indicated in the opposition notice but a certificate is attached, it is considered that the Member State is sufficiently identified, even if the certificate is not in the language of the proceedings. A translation of the certificate should not be asked for at this stage in the proceedings. Where a certificate of an international registration is concerned it is assumed that the opposition is based on this mark in all the designated Member States and/or the Benelux countries indicated in the certificate. However, the basic registration is an independent earlier right, which may be claimed separately.

Trade marks filed by an agent

Article 8(3) CTMR Rule 15(2)(b)(i) CTMIR

A trade mark filed by an agent is a contested CTM application in relation to which the opponent claims that the applicant, who has or had a business relationship with the opponent (its agent or its representative), applied for the mark without its consent.

The earlier marks or rights on which the opposition is based must be identified according to the same criteria as earlier trade mark registrations or applications, that is to say, the country and registration or application number must be given. The representation of the mark (in colour if applicable) must be given only if the proprietor's earlier mark is an unregistered mark, because in this case no registration number can be provided to clearly identify the earlier mark. For unregistered word marks, the word that makes up the mark must be indicated. For unregistered figurative or other marks, the representation of the mark as it is used and claimed by the proprietor must be

provided. See also the Guidelines, Part C, Opposition, Section 3, Unauthorised Filing by Agents of the TM Proprietor (Article 8(3) CTMR).

Earlier trade mark registrations or applications with reputation

Article 8 (5) CTMR
Rule 15(2)(c), (g) CTMIR

Under Article 8(5) CTMR an opposition can be based on a mark with reputation, invoked against goods and services that are dissimilar and/or similar. The mark with a reputation can be an earlier Community, international, Benelux and national registration, and an earlier application subject to its registration.

The same identification requirements apply as for registered marks invoked under Article 8(1)(b) CTMR: number and Member State/region of protection. The indication where and for which goods/services the mark is reputed is a relative admissibility requirement.

Earlier well-known mark

Article 8(2)(c) CTMR
Rule 15(2)(b)(i), (ii) and Rule 17(2) CTMIR

Article 8(2)(c) CTMR protects well-known marks within the meaning of Article 6*bis* of the Paris Convention. This can be a registered or an unregistered mark or a mark that is not registered in the territory where it is to be protected (irrespective of registration in the territory of origin).

The absolute indications are:

- An indication of the Member State where the mark is well known: if this indication cannot be deduced from the documents on file, the mark is inadmissible as a basis for opposition.
- If the mark is a registered mark, the indications referred to in Rule 15(2)(b)(i) CTMIR, i.e. the registration number and the Member State where the mark is registered.
- If the mark is not registered, a representation of the mark. For word marks, this is the indication of the word that makes up the mark. For figurative or other marks, the representation of the mark (in colour if applicable) as it is used and claimed to be well-known must be provided. If the opposition is furthermore based on one registered trade mark, but no representation of the well-known mark is given, the Office assumes that both trade marks refer to the same sign and that the opponent claims the registered mark to be well-known (decision of 17/10/2007, R 0160/2007-1, QUART/Quarto).

Earlier non-registered marks and earlier signs used in the course of trade

Article 8(4) CTMR
Rule 15(2)(b)(iii) and Rule 17(2) CTMIR

This category consists of signs that are unregistered and used as trade marks or of a great number of different earlier rights, inter alia rights to a company name, trade name, business sign, ensigns, titles of protected literary/artistic work and the right to a sign under passing off.

The absolute indications are:

- an indication of the kind or nature of the right. The nature of the right determines the scope of the opposition and the applicant's defence depends on it. 'Trade name', 'company name', 'business sign', 'passing off', 'titles of protected literary/artistic works' are acceptable indications of the nature of rights. By contrast, general terms such as 'common law' and 'unfair competition' without an indication of the specific nature of the right are not accepted. This list is not exhaustive. If the opponent bases its opposition on a right that cannot be an earlier right under Article 8(4) CTMR, e.g. a copyright or a design, the opposition is admissible. However, after the proceedings have commenced the opposition will be rejected on substance;
- an indication of the Member State where the right is claimed to exist;
- a representation of the earlier right (in colour if applicable).

In the absence of the previous indications, the relevant right will be inadmissible.

2.4.1.3 Identification of grounds

Article 41(3) and Article 75 CMTR
Rule 15(2)(c) and Rule 17(2) CTMIR

An opposition without any indication of grounds is inadmissible if this deficiency is not remedied before the expiry of the opposition period.

The specification of the grounds should consist of a statement to the effect that the respective requirements under Article 8 CTMR are fulfilled. Arguments and evidence are voluntary at this point in the proceedings.

In particular, the grounds are to be considered as properly indicated if:

- one of the relevant boxes in the opposition form is checked;
- the relevant box is not checked, but the earlier mark is identified and the opposition can be considered to be based on Article 8(1) CTMR.

In both cases it is possible to identify the grounds from the notice of opposition without any doubt and the opposition is admissible.

Otherwise, before rejecting the opposition, a careful assessment of the entire notice of opposition must be made: whether indicated in the opposition form, its annexes or its supporting documents, the grounds must be unequivocally clear.

In all other cases, the opponent will be invited to present comments on inadmissibility before taking the decision rejecting the opposition.

2.4.2 Relative admissibility requirements

Rule 15(2)(d)-(h) CTMIR

Relative deficiencies are those that can be remedied after the expiry of the opposition period. The Office invites the opponent to remedy the deficiency within two months from notification of the deficiencies. If the opponent remedies the deficiencies, the opposition is considered admissible; if not, it will be rejected on the grounds of inadmissibility.

2.4.2.1 Dates

Rule 15(2)(d) and Rule 17(4) CTMIR

These include the filing date and, where available, the registration date and the priority date of the earlier mark.

This requirement applies to the following rights:

- earlier Community or national or international trade mark applications or registrations invoked under Article 8(1)(a) or (b) CTMR,
- earlier well-known marks invoked under Article 8(2)(c) CTMR, if they are registered in the Community,
- earlier marks under Article 8(3) CTMR if they are registered,
- earlier marks with a reputation invoked under Article 8(5) CTMR.

These indications can be important in order to be able to eliminate possible errors when identifying the earlier mark. It is sufficient that these elements can be found in enclosed documents. If these elements are missing the opponent must be notified of the deficiency.

2.4.2.2 Representation of earlier marks/signs

Rule 15(2)(e) and Rules 80(2) and 17(4) CTMIR

For rights that are not subject to registration this is an absolute admissibility requirement as otherwise the earlier right cannot be determined at all (see above).

The relative admissibility requirement to provide a representation of the mark under Rule 15(2)(e) CTMIR applies to the following rights:

- earlier national or international trade mark applications or registrations invoked under Article 8(1)(a) or (b) CTMR,
- earlier well-known marks invoked under Article 8(2)(c) CTMR, if they are registered in the Community,
- earlier marks with a reputation invoked under Article 8(5) CTMR,
- marks filed by an agent (Article 8(3) CTMR, if they are registered marks).

If a proper representation of the mark/sign has not been enclosed in the opposition notice, the opponent will be notified of the deficiency. If the opponent does not comply within the two-month time limit given, the earlier right will be rejected as inadmissible.

If the earlier mark is a CTM, no representation is requested since it is available in the Office's databases.

If the mark is a word mark, an indication of the word is sufficient to consider that a proper representation of the mark has been submitted.

For the same purpose, if the mark is figurative, 3-D, other mark, etc., the representation of the mark as applied for or registered must be filed. When the trade mark is in colour, at least a representation of the mark in colour must be submitted.

An earlier mark will be identified as a trade mark in colour only when a representation of the mark in colour is enclosed, or an indication in this regard is mentioned in the opposition notice or in the documents attached to it. Therefore, when an indication in this regard is contained in the submitted documents without it being accompanied by a representation of the mark in colour (i.e. no graphical representation of the mark or a representation of the mark in B&W is filed), the Office will notify this deficiency. If the opponent does not comply within the two-month time limit given, the earlier right will be rejected as inadmissible.

A colour representation of the mark is not compulsory if the national mark was not published (for technical reasons) in colour, as is the practice, for example, in Cyprus and Latvia. In these cases the Office neither asks for a colour representation nor requests the opponent to file a translation of the colour indications submitted in the original language.

The following countries have either always published in colour or have done so since the date indicated:

- Belgium
- Bulgaria
- Czech Republic (1999)
- Denmark
- Germany
- Estonia (2003)
- Ireland (2003)
- Greece (2007)
- Spain (as of 31/07/2002)

- France (1992)
- Croatia (2009)
- Italy
- Lithuania (as of July 2009)
- Luxembourg
- Hungary
- Malta
- Netherlands
- Austria
- Poland (2003)
- Portugal (2006)
- Romania
- Slovenia (1992)
- Slovakia (2008)
- Finland (2005)
- Sweden
- United Kingdom (2004).

International marks have been published in colour since 1989.

If the representation on file is not clear, the Office may ask for a clearer one. If the representation that is received is incomplete or illegible and the request to provide a clear one is not complied with, the representation will be deemed not to have been received and the right will be rejected as inadmissible.

2.4.2.3 Goods and services

Rule 15(2)(f) and Rule 17(4) CTMIR Communication No 5/07 of the President of the Office
--

Rule 15(2)(f) CTMIR stipulates that the notice of opposition must contain an indication of the goods and services on which the opposition is based in the language of the proceedings. This applies to all types of earlier rights.

The opposition can be based on all the goods and services for which the earlier mark is registered or applied for, or only some of the goods and services.

According to Communication No 5/07 of the President of the Office of 12/09/2007 on changes of practice in opposition proceedings, an indication of the class number(s) is accepted as sufficient indication of the goods and services of the earlier rights on which the opposition is based. This is implemented as described below.

Part of the goods and services

If the opposition is based on part of the goods and services for which the earlier mark(s) is/are registered/applied for, these goods and services need to be listed in the language of the proceedings.

The Office will also accept an indication of the relevant class number(s), provided that a registration certificate or extract from an official source is attached (the registration certificate or extract must either be in the language of the proceedings or be translated

into the language of the proceedings or make use of national or INID codes so as to clearly identify the relevant class number(s)).

If the goods and services on which the opposition is based are fewer than the goods and services for which the mark is registered, the goods and services on which the opposition is not based need not be indicated, as they are irrelevant to the proceedings.

All of the goods and services

If the opposition is based on all of the goods and services for which the earlier mark(s) is/are registered/applied for, these must be listed in the language of the proceedings.

However, instead of listing them, the opponent may refer to 'all goods and services for which the earlier mark is registered', provided that a registration certificate or extract from an official source is attached (the registration certificate or extract must either be in the language of the proceedings or be translated into the language of the proceedings or make use of national or INID codes).

The Office will also accept an indication of the relevant class number(s) provided that a registration certificate or extract from an official source is attached (the registration certificate or extract must either be in the language of the proceedings or be translated into the language of the proceedings or make use of national or INID codes so as to clearly identify the relevant class number(s)).

Additionally, where the opponent indicates in the opposition form that the opposition is based on 'all goods and services for which the earlier right is registered' but then lists only 'part' of these goods and services (when compared with the registration certificate or relevant official extract attached to the opposition form) the Office will, in order to overcome the contradictory information contained in the notice of opposition, assume that the opposition is based on 'all goods and services for which the earlier right is registered'.

Even if the opponent has not indicated, or has not clearly indicated, on which goods and/or services it bases its opposition, it is sufficient that a registration certificate in the language of the proceedings is attached; it is then assumed that the opposition is based on the goods and services that appear in the certificate.

However, if the certificate is in a language other than the language of the proceedings or if no certificate is attached, the deficiency must be notified.

If an opposition is based on 'all identical/similar goods and services', clarification must be requested since this wording is not sufficiently clear to identify the basis of the opposition.

If an indication like 'the opposition is based on all the goods in Class 9' is used and no certificate in the language of the proceedings is attached, the Office will require a specification in the language of the proceedings.

An indication of this type is only acceptable when the opponent replies that it owns a registration with a description that mentions that the sign is registered for 'all goods in Class 9'.

For oppositions based on earlier unregistered trade marks or rights, the opponent must indicate the commercial activities in the course of which they are used.

Specific aspects: oppositions filed against international registrations designating the EU

For admissibility purposes, with regard to oppositions filed against international registrations designating the EU, an indication of the class number(s) only in the notice of opposition is not sufficient to identify the goods and services on which the opposition is based. If the opposition is based on all or part of the goods and services for which the earlier mark(s) is/are registered/applied for, these goods and services need to be listed in the language of the opposition proceedings. This list must include all the goods or services covered by that mark or at least the relevant goods or services on which the opposition is based.

2.4.2.4 Earlier mark with a reputation: scope of reputation

Rule 15(2)(g) CTMIR

A specific requirement applies to marks with a reputation within the meaning of Article 8(5) CTMR: an indication of the Member State in which, and the goods and services for which, the mark has a reputation must be provided.

2.4.2.5 Identification of the opponent

Article 41(1) CTMR
Rule 1(1)(b) and Rule 15(2)(h)(i) CTMIR

The opponent can either be a natural or a legal person. In order to be able to identify the opponent, there must be an indication of its name and address.

Until now there have been no oppositions where the opponent was not identified. If only the name of the opponent and, for example, a fax number is indicated, the opponent must be asked to give the particulars of its address.

When examining whether the opponent is clearly identified, attention should be given to the nature of the opponent, i.e. natural or legal person. If it is unclear whether the opponent is a natural or a legal person, or when the type of legal person (for example GmbH, KG, SA, Ltd) is not indicated, the deficiency must be notified.

Entitlement

Rule 1(1)(b) and Rule 15(2)(h)(i) and (iii) CTMIR

It is assumed that the opponent claims to be the owner of the earlier right, unless otherwise stated. Only if the opponent acts in the capacity of an authorised licensee or a person authorised under national law, does it have to make a statement to that effect, and it has to specify the basis on which it is so entitled or authorised. If those details are not given, a deficiency must be notified.

In accordance with Rule 15(2)(h)(i) CTMIR an opponent who acts as a licensee or authorised person has to indicate its name and address in accordance with Rule 1(1)(b) CTMIR.

- If the notice of opposition is based on the grounds of Articles 8(1) or 8(5) CTMR and thus on trade mark registrations or applications, the notice of opposition may be filed by the owner and by the licensees of these registrations or applications, provided they are authorised by the owner.
- If the notice of opposition is based on the grounds of Article 8(3) CTMR (an agent trade mark), it may be filed by the owner of that trade mark.
- If the notice of opposition is based on the grounds of Article 8(4) CTMR (earlier marks or signs), it may be filed by the owner of that earlier mark or sign and by persons authorised under the relevant national law to exercise the rights to the earlier mark or sign.

As long as the opponent claims to own a right or registration in one of the Member States of the European Union, it is entitled to file an opposition, irrespective of its country of origin.

Change of owner (transfer of earlier mark) before the opposition is filed

Where the earlier mark has been transferred before the opposition is filed, a distinction has to be made between oppositions based on an earlier CTM and oppositions based on national trade mark registrations (or applications).

Oppositions based on an earlier CTM

An opposition based on Community registrations or applications may be entered by the successor in title of a CTM only if the conditions set out in Article 17(6) CTMR are met, namely, only if the opponent has submitted a request for the registration of the transfer when the opposition is filed. According to Article 17(7) CTMR, where there are time limits to be observed vis-à-vis the Office, the successor in title may make the corresponding statements to the Office once the request for registration of the transfer has been received by the Office.

It is up to the opponent to provide this information, and it will not be checked by the Office during the admissibility check. However, if the opponent mentions in the explanation of its opposition that it is the new owner (or uses similar terms), the Office must request the opponent to indicate the date the request for registration of the transfer was sent to or received by the Office.

Opposition based on a national registration or application

An opposition based on a national registration or application may be entered by the 'old' owner or by the successor in title, as there are different practices in the different Member States regarding the need to register the transfer in the national trade mark register in order to be able to claim rights arising from the registration.

In some cases the opposition is filed by opponent A whereas, after a transfer of the earlier mark on which the opposition is based, the mark is owned by B. As A may still

appear in the relevant register as the owner, the Office will accept the opposition as valid with A as opponent, even though it is no longer the owner of the earlier mark.

If the opposition is filed with B as opponent and a copy of the registration certificate shows A as owner of the earlier mark, the opposition is accepted as admissible on the assumption that the earlier mark was transferred to B before the opposition was filed (or it is indicated in the notice of opposition that it opposes in its capacity as licensee). However, the entitlement to file the opposition (e. g. evidence of the transfer or of the granting of a licence before the opposition was filed) has to be proved within the time limit for substantiation.

Multiple opponents

Rules 15(1) and 75(1) CTMIR
Decision of 11/10/2000, R 0623/1999-1, Emultech

In some cases there is more than one opponent indicated in the notice of opposition. There are only two situations in which the Office accepts two or more separate persons (either natural or legal) as multiple opponents, namely:

- if they are co-owners of the earlier mark or right;
- if the opposition is filed by the owner or co-owner of an earlier mark or right together with one or more licensees of these earlier marks/rights.

If there is no indication that the multiple opponents fulfil one of the two requirements mentioned above, they will be asked to indicate their relationship (co-ownership or owner/licensee) or to indicate one of the multiple opponents as the only opponent.

If an earlier mark and/or an earlier right has more than one proprietor (co-ownership), the opposition may be filed by any or all of them.

However, if the opponents inform the Office that, for example, Company A B.V. owns five of the earlier rights and Company A PLC owns another five, they will have to indicate with whom the opposition will continue. As a consequence, five out of the ten earlier rights will not be taken into account. If the opponents do not respond appropriately within the two-month time limit set, the opposition will be rejected as inadmissible.

Acceptable

Earlier trade marks	1	2	3	4	5
Owner	A/B	A	A	A	A

Earlier trade marks	1	2	3	4	5
Owners	A/B	A/C	A	A	A

The second combination is acceptable only if at least A is one of the opponents.

Not acceptable

Earlier trade marks	1	2	3	4	5
Owners	A	A	B	B	B

The opponents will have to be asked to indicate whether they want to continue the proceedings with A or B as an opponent.

Earlier trade marks	1	2	3	4	5
Owners	A/B	A	A	B	B

The opponents will have to be asked to continue the opposition either as multiple opponents based on the first three earlier trade marks or as multiple opponents based on the first, fourth and fifth earlier trade marks.

Earlier trade marks	1	2	3	4	5
Owners	A/B/C	B/C	A	A	A

The opponents will have to be asked to continue the opposition either as multiple opponents A, B and C based on the first and the second earlier trade marks or as multiple opponents A and B based on the first, third, fourth and fifth earlier trade marks.

Indication of relationships other than co-ownership

Where two opponents are mentioned in the notice of opposition, one as owner of the earlier right, and another as licensee (authorised by the owner to file opposition), no objections will be raised if the owner of all earlier rights on which the opposition is based is the same legal or natural person, regardless of how many licensees join it in the case.

In the following example the opposition is acceptable with A, B and C as multiple opponents:

Earlier trade marks	1	2	3
Owner	A	A	A
Licensees	B	C	None

By contrast, in the following case, although B is accepted as a multiple opponent as licensee for earlier mark 1, it cannot be accepted as a multiple opponent as owner of earlier mark 3. The Office will ask the opponents to indicate whether they want to continue the opposition with A or with B as an opponent. If the opponents do not reply, the opposition is inadmissible.

Earlier trade marks	1	2	3
Owner	A	A	B
Licensees	B	C	A

Evidence

In cases where the opposition is based on earlier registered marks, the most common means to provide evidence of co-ownership is to submit a copy of the registration certificate or an extract from an official database. If the opposition is based on several earlier marks/rights but the opponents have already submitted evidence of co-ownership of one earlier registered mark, the opponents will still be required to confirm the ownership of the other earlier rights. As at this stage of the opposition proceedings the opponents are not obliged to submit evidence of their earlier marks/rights, a statement confirming their capacity to file an opposition together will be considered sufficient for admissibility purposes.

2.4.2.6 Professional representation

Representative

Articles 92 and 93 CTMR Rule 15(2)(h)(ii) CTMIR
--

Rule 15(2)(h)(ii) CTMIR provides that if the opponent has designated a representative, it must provide the name and business address of the representative in accordance with Rule 1(1)(e) CTMIR.

If the opponent is from the EU (not obliged to be represented under Article 92 CTMR), failure to appoint a representative, or failure to indicate the name or business address of the representative, merely has the consequence that the Office will communicate with the opponent directly.

If the opponent is obliged to be represented under Article 92 CTMR, failure to appoint a representative, or failure to indicate the name or business address of the representative, constitutes a relative admissibility deficiency. The Office will invite the opponent to appoint a representative and/or to indicate the name and address of the representative, failing which the opposition will be rejected as inadmissible.

Rule 77 CTMIR

Any Office notification sent to the duly authorised representative has the same effect as if it had been addressed to the represented person.

Any notification or letter of the duly authorised representative sent to the Office has the same effect as if it originated from the represented person.

In addition, if the represented person itself files documents with the Office while being represented by a duly authorised representative, these documents will be accepted by the Office as long as the represented person has its domicile or its principal place of business or a real and effective industrial or commercial establishment in the EU. If this is not the case, the documents submitted will be rejected.

For further information, see the Guidelines, Part A, General Rules, Section 5, Professional Representation.

Multiple representatives, common representative

Rule 75 CTMIR

It is possible for each party to have more than one representative, who may act either jointly or separately. There is no fixed maximum number of representatives.

The Office, however, will communicate only with the first named representative. If there is more than one opponent and the notice of opposition does not name a common representative, the representative first named in the opposition notice will be considered to be the common representative.

However, if one of the opponents is obliged to appoint a representative (because he or she is from outside the European Union), this representative will be considered to be the common representative, unless the opponent first named in the opposition notice has appointed a representative.

Rule 76(8) CTMIR

Where there is more than one opponent/applicant, the representative of the person named first will be the common representative of all these persons. If the person first named has not appointed a representative and one of those persons is obliged to appoint a representative and has done so, that representative will be considered to be the common representative for all these persons.

For further information, see the Guidelines Part A, General Rules, Section 5, Professional Representation.

Change of representative

Rule 76 CTMIR

During the opposition proceedings the opponent's and the applicant's representative may change. For further information, see the Guidelines, Part A, General Rules, Section 5, Professional Representation.

Authorisation

Article 92(2) CTMR
Rule 76 CTMIR

Where there are several parties to the proceedings in which a representative acts before the Office, representatives must file a signed authorisation for entry into the file, either as an individual or as a general authorisation, only if the other party expressly asks for it. When it is required that a signed authorisation is filed, the Office will specify a time limit within which such an authorisation must be filed.

Details on representation and authorisations are set out in the Guidelines Part A, General Rules, Section 5, Professional Representation.

2.4.2.7 Signature

Rules 80(3) and 82(3) CTMIR

A notice of opposition sent by fax or by mail must be signed by the opponent or, if it is submitted by a representative, by the representative.

A notice of opposition sent by electronic means need not be signed and it is sufficient that the name of the sender is indicated.

2.4.2.8 Relative admissibility requirements: sanctions

Rule 17(4) CTMIR

If relative admissibility requirements are missing or not complied with, the opponent or its representative is given two months to remedy this deficiency. This time limit cannot be extended.

If the deficiency is not remedied in time, the opposition must be rejected as inadmissible or, if the deficiency concerns part of the earlier rights, the opponent will be notified that the opposition is admissible but that the earlier rights concerned cannot be taken into account.

2.4.3 Optional indications

2.4.3.1 Extent of the opposition

Rule 15(3)(a) CTMIR

The opposition may contain an indication of the goods and services against which the opposition is directed; in the absence of such an indication, the opposition will be considered to be directed against all of the goods and services of the opposed mark.

If the opponent indicates that the opposition is only directed against part of the goods and services of the CTM application, it will have to list these goods **clearly**. If it does not do so, either in the notice of opposition or in the explanation, it must be notified of the deficiency. If the deficiency is not remedied by listing the goods and/or services against which the opposition is directed within the time limit given, the opposition will be rejected as inadmissible.

There are cases where, in reply to the Office's letter asking the opponent to list exactly which part of the goods and services it opposes, the opponent indicates 'all the goods and services which the contested mark is applied for'. The Office cannot accept this indication as valid and the opposition must be rejected as inadmissible. This is because by indicating that the opposition is directed only against part of the goods and services of the CTM application, the opponent has clearly limited its opposition in this respect and cannot extend its scope after the opposition period of three months.

The extent of the opposition is correctly indicated where the goods are specific goods encompassed by a broader term used in the contested specification (e.g. opposition

directed against *trousers* and the CTM application is filed for *clothing* — in this example, the only contested goods are considered to be *trousers*). However, when the opponent uses ambiguous wording like ‘the opposition is directed against all goods similar to ...’, when the opponent’s goods are substituted for applicant’s goods, or any other indication that does not clearly identify the contested goods and services, a clarification must be requested. If the opponent does not respond appropriately to this request, the opposition will be rejected as inadmissible.

Additionally, where the opponent indicates in the opposition form that the opposition is directed against ‘part of the goods and services of the contested mark’ but then lists ‘all’ of these goods and services in the notice of opposition or in the annexes, the Office will, in order to overcome the contradictory information contained in the notice of opposition, assume that the opposition is directed against ‘all the goods and services’.

2.4.3.2 Reasoned statement

Rule 15(3)(b) CTMIR

It is now clear from the wording of Rule 15 CTMIR that a distinction must be made between:

- the basis of the opposition, i.e. the earlier right invoked; it must be properly identified and cannot be changed after expiry of the opposition period,
- the indication of the grounds of the opposition, e.g. ‘likelihood of confusion’,
- and a reasoned statement, i.e. any indication of arguments, facts or evidence in support of the opposition.

‘Reasoned statement’ includes proof of the existence of the earlier right, which (unlike the identification of the earlier right) is a matter of substance rather than admissibility.

The reasoned statement is optional at the stage of filing of the opposition; it has nothing to do with the admissibility check. It is acceptable if it is included in the opposition, but otherwise it may be provided after expiry of the cooling-off period (Rule 19(1) CTMIR) and concerns the substance, not the admissibility, of the opposition.

2.5 Notification of the notice of opposition

Rules 16a, 17 and 18 CTMIR Decision EX-13-2 of the President of the Office

Any notice of opposition and any document submitted by the opposing party, as well as any communication addressed to one of the parties by the Office prior to the commencement of the cooling-off period, will be sent by the Office to the other party for information purposes.

Once the opposition has been found admissible, the Office will send a notification to the parties informing them that the proceedings are deemed to commence two months after receipt of the communication. The notification will also set the time limit for the

opponent to present the facts, evidence and arguments in support of its opposition, as well as the time limit for the applicant to submit its observations in reply. It is important to note that due to different means of communication (e-communication, fax and post) the time limits mentioned in this notification are set according to the 'slowest' communication channel. For example, if one of the parties is notified by e-communication through the official web page of the Office, notification is deemed to have taken place on the fifth calendar day following the day on which the document was created by the Office's systems. Therefore, if the notification to the other party is sent by fax, this latter party will also be granted the five additional days so that the time limits granted in the notifications coincide.

Whenever the opposition is based on an earlier trade mark registered or applied for in colour, the Office will ensure that the colour representation is received by the applicant. In some cases this may require notification by post.

Notification is not carried out before the expiry of the opposition period.

3 Cooling-Off Period

3.1 Setting the cooling-off period in motion

Rule 17, Rule 18(1), Rule 19 and Rule 20(2), (6), (7) CTMIR
Communication 1/06 of the President of the Office

When the opposition is found admissible, the Office sends a notification to the parties informing them that the opposition is deemed admissible and that the proceedings are deemed to commence two months after receipt of the notification (a two-month 'cooling-off' period is granted before the proceedings officially start, with legal consequences as regards the opposition fees in particular).

According to the judgment of the Court of Justice of 18/10/2012 in case C-402/11 P, REDTUBE (EU:C:2012:649), the notification sent to the parties informing them that the opposition is admissible in accordance with Rule 18(1) CTMIR constitutes a decision that may be appealed together with the final decision on the case as stated in Article 58(2) CTMR. Consequently, the Office is bound by this decision.

The cooling-off period will be set to expire two months from the notification. The exact date of expiry is indicated in the Office's notification. This date will always be two months from the notification date, even if this is a day on which the Office is not open, e.g. a Saturday or Sunday.

The cooling-off period may last up to a total of 24 months if both parties submit requests for an extension before the period expires. The Office will grant an extension of 22 months, irrespective of what length of extension is requested.

It is not possible to circumvent the limitation of the cooling-off period to 24 months by requesting a suspension. Requests can be accepted at this stage but will only have effect once the cooling-off period has expired. When the parties invoke on-going negotiations, the proceedings will not be suspended during the cooling-off period, but a request for such a suspension may be made after the expiry of the cooling-off period.

The opponent will be given a time limit of two months after the expiry of the cooling-off period to submit facts, evidence or arguments irrespective of whether it has already

submitted such facts, evidence or arguments together with the notice of opposition. Within the same time limit, the opponent must also substantiate its earlier right(s).

The request to the opponent is a **general invitation** to complete the file within the meaning of Rule 19 CTMIR. The Office will **not** indicate the nature and type of the material necessary for completion of the file (see expressly Rule 20(6), second sentence, CTMIR). Rather, it will be for the opponent to decide what it wishes to submit. In order to facilitate the task of opponents, the Office has prepared a list that enumerates the type of evidence generally required, depending on the nature of each right. This list is forwarded to the opponents as an annex to the notification of the admissibility of the opposition and it may be referred to by opponents as a checklist in preparing their oppositions.

In practice, the time limit for submitting such additional material will be set at four months from the date of notification. Therefore, opponents should be aware that the time limit for submitting such additional material is not a time limit of two months beginning after the cooling-off period has expired, but a time limit of four months from the notification.

The applicant will be given an additional time limit of two months for replying to the opposition. Rather than setting a separate time limit of two months (two months for the cooling-off period, two months for completing the opposition, two months for replying), the time limit for replying to the opposition will be set at six months from the notification of admissibility (day of the start of the cooling-off period).

When the opponent completes its opposition any time after the notification and before the expiry of the four months available to it, the additional material will be forwarded to the applicant without any change in the time limit available for responding to the opposition. However, if the additional material arrives at the Office without sufficient time to forward it to the applicant within the time limit set for the opponent, the additional material will then be forwarded to the applicant together with the setting of a new time limit of two months for replying to the opposition. This separately set two-month time limit will run from the date of the receipt of the notification of the additional material in order to ensure that the applicant always has a full time limit of two months to prepare its reply.

3.2 Extension of the cooling-off period

Article 119(5), (6) CTMR Rules 18(1) and 96(1) CTMIR Communication 1/06 of the President of the Office
--

The cooling-off period may be extended up to a total of 24 months.

To extend the cooling-off period the following is necessary.

- A signed request from both parties. This may take the form of either two separate requests or one joint request. It is not necessary to state a reason for the extension.
- The request must be in the language of the proceedings. Alternatively, the request can be filed in one of the Office languages. However, a translation must

be filed within one month of filing on the parties' own initiative. The Office does not send any letter requesting a translation of the request for extension.

- The request must be filed before the expiry of the cooling-off period. Any request filed after the expiry of the cooling-off period will have to be rejected. If one party files the request within but the other after expiry of the cooling-off period, the extension is also to be refused.

The extension of the cooling-off period must be distinguished from requests for extension of a time limit or a suspension. In the event that the request for extension is inadmissible because it has been filed late or because the cooling-off period had already been extended, it will be treated as a request for suspension provided that the conditions of such a request are fulfilled.

The extension is granted for a period of 24 months to be counted from the date of the start of the cooling-off period. This procedure avoids multiple extensions and at the same time leaves the parties maximum freedom to decide when they want to continue with the adversarial stage of the proceedings.

Any party can then bring the extended cooling-off period to an end (opt out) by expressly indicating this in writing.

It is immaterial whether the other party agrees with this or not.

When one of the parties opts out before expiry of the extended cooling-off period, the Office will confirm this to both parties and set the cooling-off period to expire two weeks after said notification. The adversarial part of the proceedings will commence the day after. In the same notification new time limits are notified for the substantiation of the opposition and the reply of the applicant, which will be two and four months from the end of the cooling-off period.

Opting out is irrevocable. Opting out during the last month before commencement of the proceedings will not be accepted.

4 Adversarial Stage

4.1 Completion of the opposition

Within two months after expiry of the cooling-off period, the opponent may submit additional facts, evidence and arguments in support of its opposition.

Within the same time limit, the opponent must prove the existence and validity of its invoked earlier rights.

4.2 Substantiation

Article 41 CTMR
Rule 19, Rule 20(1) and Rule 79 CTMIR

Substantiation is defined by Rule 19(2) CTMIR and refers to the proof of existence, validity and scope of protection of the earlier mark(s) or right(s) as well as the proof of entitlement to file the opposition.

After the parties have been notified of the admissibility of the opposition, the opponent has two months counted from the end of the cooling-off period in which not only to complete its file, that is, present all the evidence in support of its opposition, but also to prove the existence and validity of the earlier rights invoked and its entitlement to file the opposition. Where relevant for the opposition, the opponent must also submit evidence of reputation, enhanced distinctiveness or any other aspect affecting the scope of protection of its earlier right(s).

The evidence must be in the language of the proceedings or accompanied by a translation for substantiation purposes. The translation must be provided within the time limit for submitting the original. The Office will not take into account documents or parts thereof that have not been submitted or that have not been translated into the language of the proceedings within the time limit set by the Office.

Unless submitted by fax transmission or electronic communication, any supporting document or other evidence must be presented in two copies, one being for transmission to the other party. Exceptions to this rule are all paper documents (such as loose sheets of evidence) up to and including A3 size. However, any other item of evidence (larger than A3 or not being paper, such as CDs, DVDs, USBs, product samples, etc.) that has been submitted to the Office by post or personal delivery must be accompanied by a second copy. If no copy is provided, these documents or items of evidence will not be taken into account.

If the opponent has not proven the existence of at least one earlier right, the opposition will be refused as unfounded.

If the earlier right that has been found admissible is not substantiated at the substantiation stage and there is/are another/other earlier right(s) that is/are substantiated, the absolute admissibility requirements for that/those earlier right(s) must be checked.

The opponent has to show its entitlement to file the opposition for the purpose of substantiation (see paragraph 4.2.3.7 below).

4.2.1 CTMs and CTM applications

If the earlier mark or application is a CTM, the opponent does not have to submit any documents as far as the existence and validity of the CTM(A) is concerned. The examination of the substantiation will be done *ex officio* with respect to the data contained in the Office's database.

4.2.2 Converted CTM(A)s

Article 112(1) CTMR

This section will deal only with specific aspects of conversion in opposition proceedings. For further information on conversion, see the Guidelines, Part E, Register Operations, Section 2, Conversion.

4.2.2.1 Opposition based on CTM(A) (to be) converted

National applications deriving from the conversion of an earlier CTM or CTM application are considered to come into existence as soon as a valid conversion request is submitted. Such rights will be properly substantiated under Rule 19(2) CTMIR if the opponent indicates the number of the CTM (or CTM application) under conversion and the countries for which it has requested the conversion.

4.2.2.2 Opposition based on CTM(A) that is subsequently converted

When during opposition proceedings the CTM application (or CTM) on which the opposition is based ceases to exist (or the list of goods and services is restricted), and a request for conversion is submitted, the proceedings can continue. This is because national trade mark registrations resulting from a conversion of a CTM application can constitute the basis of the opposition procedure originally made on the basis of that CTM application (decision of 15/07/2008, R 1313/2006-G, CARDIVA/CARDIMA).

In such a case the Office will request the opponent in writing to inform the Office whether it maintains the opposition in view of the withdrawal, surrender or rejection of the earlier CTM application(s) or registration(s) and whether it intends to rely on the national applications that result from the conversion of the earlier CTM. If the opponent does not inform the Office within the established time limit that it wishes to rely on the national applications, the opposition will be rejected as unfounded.

Evidence of the existence of the earlier national applications must be submitted by the opponent as soon as they become available.

4.2.3 Trade mark registrations or applications that are not CTMs

Rule 19 (2)(a)(i) and (ii) CTMIR

To substantiate an earlier trade mark application or registration the opponent must provide the Office with evidence of its filing or registration. The Office accepts the following documents:

- certificates issued by the appropriate official body
- extracts from official databases
- extracts from official bulletins of the relevant national trade mark offices and WIPO.

4.2.3.1 Certificates issued by the appropriate official body

Any registration certificate or the most recent renewal certificate showing the validity of the earlier mark beyond the time limit that was given to the opponent to substantiate its opposition, issued by a national office, or by WIPO if it concerns an international registration, constitutes valid evidence. For further requirements relating to renewal certificates, see below.

If the opposition is based on an application, the opponent must submit evidence that the application was filed at the national office or that an international application was filed with WIPO. Once the earlier application has proceeded to registration, the opponent must submit evidence of registration. If, after the adversarial part of the proceedings, the opponent provides evidence that the national application in fact proceeded to registration before the time limit set in Rule 19(1) CTMIR, the earlier mark will be rejected as unfounded under Rule 20(1) CTMIR. An application certificate is not sufficient to prove that the trade mark has been registered. In other words, it cannot serve to prove the existence of a trade mark registration.

Some certificates present only a few differences between an application form and the registration certificate and have to be checked carefully.

Equivalent documents are also accepted if they are issued by the administration with which the mark is registered (such as a certificate of registration).

4.2.3.2 Extracts from official databases

Extracts from databases are accepted only if their origin is an official database, i.e. the official database of one of the national offices or WIPO, and if they are equivalent to a certificate of registration or last renewal. The unaltered electronic image of an online database extract reproduced on a separate sheet is also acceptable as long as it contains an official identification of the authority or database from which it originates. Extracts from commercial databases are not accepted, even if they reproduce exactly the same information as the official extracts. Examples of extracts that are not accepted are DEMAS, MARQUESA, COMPUSERVE, THOMSON, OLIVIA, PATLINK, SAEGIS or COMPUMARK.

Officially accepted databases include:

- **TMview**: for CTMs and trade marks applied for or registered with the participating offices (as long as it contains the relevant data). For further information see: <http://www.tmview.europa.eu/tmview/welcome.html>.
- **BENELUX-MERKEN** (for Benelux trade marks),
- **DPINFO** (for German trade marks),
- **SITADEX** (for Spanish trade marks),
- **OPTICS** and extracts from the UKIPO website (for UK trade marks),
- **S.A.R.A, UIBM** on-line from the UIBM website and Telemaco from the Italian Chambers of Commerce (for Italian marks).

As regards international registrations, the following databases are accepted (judgment of 26/11/2014, T-240/13, Alifoods, EU:T:2014:994)¹:

- **ROMARIN** (the 'short' version of the extract being sufficient as long as it contains all the necessary information, but the extended or long version of the WIPO extract being preferable as it contains all the individual indications for each designated country, including the Statement of Grant of Protection)
- **TMview** (as far as it contains all the relevant data, see above).

When the extract from an official database does not contain all the required information, the opponent must supplement it with other documents from an official source showing the missing information.

Examples

Extracts from SITADEX (Spanish Office official database) sometimes do not contain the list of goods and/or services; in such cases, the opponent must submit an additional document (e.g. a publication in the official bulletin) showing the list of goods and services.

SITADEX extracts sometimes do not show the image on the same page when the mark is figurative. The image sometimes appears on a separate page. Consequently, as regards figurative Spanish trade marks, when opponents file an extract from SITADEX as evidence they must ensure that the representation of the mark appears on the same page and, if not, an additional document/page showing the image must be filed. This can be from SITADEX itself (which reproduces the image on a separate page that, when printed or saved as PDF, for example, includes an identification of the source) or from another official source (such as its publication in the official bulletin). Copying the image from SITADEX and including it electronically or otherwise in the notice of opposition form is not sufficient.

When English is the language of the proceedings, and a Portuguese trade mark is concerned, INPI also provides an English version of the Portuguese trade mark extract so, in principle, no translation would be necessary. However, as regards the list of goods and/or services, the extract itself only gives the class headings along with a warning indicating that this reference to the class heading does not necessarily reflect the goods and/or services protected under the trade mark. In this regard, the opponent must always file the original list in Portuguese (from an official source) and, where the list does not consist of a class heading, an accurate translation into English. The same also applies to official extracts from other national offices that provide an English version of their extracts, such as in Slovenia.

¹ The practice of the Office has been to accept printouts of the CTM-Online database for international registrations with EU designation. This approach contravenes Rule 19(2)(a) CTMIR. No exception to this rule is provided in Title XIII of the CTMR. The current practice came into force on 01/07/2012 and applies to all oppositions filed as from this date (on or after). The information contained in the standard letters for the notification of admissible oppositions was updated as from 01/07/2012. The old practice will only apply to oppositions with a filing date before 01/07/2012.

4.2.3.3 Extracts from official bulletins of the relevant national trade mark offices and WIPO

In all Member States the trade mark application and/or registration is published in an official bulletin. Copies of the publication are accepted as long as the document (or the accompanying observations of the opponent) indicates the origin of the publication. If this indication is missing, the evidence is insufficient to prove the validity of the mark.

Furthermore, a copy of the publication of the application is not sufficient to prove that the trade mark has been registered. In other words, it cannot serve to prove the existence of a trade mark registration.

The Office accepts the first WIPO publication of the international registration as sufficient evidence of registration although, once registered, it can still be refused by national offices during the following 12 to 18 months. Only if the applicant contests the protection of the mark in question in a given territory or for certain goods and services will the opponent have to provide evidence that the mark was not refused.

4.2.3.4 Duration of a trade mark registration

In general, the registration of a mark lasts 10 years. After this period has elapsed, the registration of the mark can be renewed every 10 years. In most of the countries, the starting point of the 10 years is the filing date, but there are exceptions.

Countries	Term of protection	Starting point
Benelux (Belgium, Luxembourg, The Netherlands)	10 years	Filing date
Bulgaria	10 years	Filing date
Czech Republic	10 years	Filing date
Denmark	10 years	Registration date
Germany	10 years	Filing date
Estonia	10 years	Registration date
Ireland	10 years for TM registered since 01/07/1996 (7/14 years renewal before that)	Registration date = filing date
Greece	10 years	Filing date
Spain	10 years for trade marks applied for since 12/05/89 (20 years for trade marks applied for before that, counting from the date of registration, and with a renewal from the filing date)	Filing date
France	10 years	Filing date
Croatia	10 years	Filing date
Italy	10 years	Filing date
Cyprus	7 years first term/14 years renewal	Filing date = registration date
Latvia	10 years	Filing date
Lithuania	10 years	Filing date
Hungary	10 years	Filing date
Malta	10 years	Registration date = filing date

Countries	Term of protection	Starting point
Austria	10 years	Registration date
Poland	10 years	Filing date
Portugal	10 years	Registration date
Romania	10 years	Filing date
Slovenia	10 years	Filing date
Slovakia	10 years	Filing date
Finland	10 years	Registration date
Sweden	10 years	Registration date
United Kingdom	10 years since 31/10/94 (trade marks applied for prior to that were, upon the completion of the registration formalities, in force for 7 years from the date of the application. Trade marks with renewal date prior to 31/10/1994 renewed for a period of 14 years)	Filing date = registration date
International registration	10 years (even if 20 years for Madrid Agreement registrations, fees must be paid in two instalments of 10 years equivalent to a renewal fee)	International registration date

According to Rule 19(2)(a)(ii) CTMIR, if the trade mark is registered, the opponent must provide evidence of registration. If the evidence submitted does not prove that an application is registered and, later, one of the parties proves that upon expiry of the time limit set under Rule 19(1) CTMIR the opponent failed to prove this, Rule 19(2)(a)(ii) CTMIR will apply, and the earlier mark will be rejected as unfounded.

4.2.3.5 Verification of evidence

It must be verified that the claims submitted by the opponent within the three-month opposition period are reflected in the evidence submitted.

The number in square brackets is the international code number used to identify the information on many, but not all, registration certificates. The opponent is not obliged to submit an explanation of the codes, either for the INID or for the national codes.

The following should be checked:

- the issuing authority;
- the filing [210] and/or registration numbers [111] (in certain countries these are, or were, different);
- the territorial extent for international registrations (i.e. in which countries the mark is protected and for what goods and services);
- the filing [220], priority [300] and registration dates [151] (in certain countries, e.g. France, the filing and registration dates found on the certificate are the same);
- a representation of the sign as filed or registered [531, 540, 541, 546, 554, 556, 557, 571, 591] and as claimed in the notice of opposition;

Where the earlier mark has been identified as being in colour during the three-month opposition period, there are two acceptable scenarios.

- 1) An official colour representation of the mark such as a registration certificate, renewal certificate, official extract, etc. is submitted that contains a reproduction of the mark in colour.
- 2) An official document is presented with the representation of the mark in black and white, together with a colour claim and a colour indication, both of which are translated into the language of the proceedings.
 - a. Where the national trade mark office does not provide a detailed colour claim identifying the colours, and instead says 'Colours claimed' (or similar wording), this is acceptable as long as this entry is translated into the language of the proceedings.
 - b. Where the national office (e.g. the Portuguese Trade Mark Office) does not provide any indication of a colour claim on its certificate or official extract, further official documents must be submitted to prove this claim (e.g. a copy of the publication of the mark in the bulletin).

However, the latter scenario is only acceptable if the opponent has also submitted a colour representation of the mark from an unofficial origin (separate sheet of paper, within the observations, attached to the notice of opposition, etc.).

Therefore, if the opponent has identified during the three-month opposition period that its figurative mark is in colour and has only submitted a black and white representation to the Office with no further evidence of a colour claim, the opposition based on that earlier right will be rejected as not substantiated in accordance with Rule 20(1) CTMIR.

Likewise, if the opponent has provided no indication during the opposition period that the earlier mark is in colour (representation in colour, or colour claim), and has only submitted a colour representation to the Office in order to substantiate its opposition, the opposition based on that earlier right will be rejected as not substantiated in accordance with Rule 20(1) CTMIR.

- the goods and services covered [511];
- the expiry date of the registration (if given);
- the owner [731, 732];
- other entries affecting the legal or procedural status or the scope of protection of the mark (e.g. disclaimers [526], restrictions, renewals, transfers, pending actions, the fact that the mark was registered due to acquired distinctiveness through use, etc.).

4.2.3.6 Renewal certificates

Rule 19(2)(a)(ii) CTMIR

If the opponent has submitted a certificate of registration but the registration is due to expire before the expiry of the time limit for substantiation, it must file a renewal certificate or equivalent document in order to prove that the term of protection of the trade mark extends **beyond** the time limit or an extension thereof has been given to it to substantiate its opposition. What counts is the date on which the registration would expire, and not the possibility to renew the mark within the six-month grace period under the Paris Convention.

When an earlier right on which the opposition is based reaches the end of protection after expiry of the time limit set by the Office to substantiate the opposition, the opposition is not automatically rejected in the absence of further communications or proof from the opponent. Rather a communication is issued to the opponent in which it is invited to submit evidence of renewal which is communicated to the applicant (judgment of 05/05/2015, T-715/13, Castello (fig.)/Castelló y Jaun S.A. (fig.) et al., EU:T:2015:256, § 68 and following).

Only if the renewal certificate contains all the necessary data that determines the scope of the protection of the earlier mark, will it suffice to file the renewal certificate without a copy of the registration certificate. For example, German renewals and sometimes Spanish renewals do not contain all the necessary data and therefore are not alone sufficient to substantiate the earlier mark.

If there is no proper evidence of renewal, the earlier registration is not substantiated and will not be taken into account.

4.2.3.7 Entitlement to file the opposition

Article 41 CTMR Rule 19(2) and Rule 15(2)(h)(iii) CTMIR
--

Depending on the ground invoked the following are entitled to file an opposition:

1. proprietors and authorised licensees for Article 8(1) and Article (5) CTMR;
2. proprietors (only) for trade marks referred to in Article 8(3) CTMR;
3. proprietors of earlier rights referred to in Article 8(4) CTMR and persons authorised under the relevant applicable national law.

Example

If the opponent is a corporation, the name of the corporation must be carefully compared with the name of the corporation that owns the prior trade mark. For instance with British companies, John Smith Ltd, John Smith PLC and John Smith (UK) Ltd are different legal entities.

If the opposition is filed with B as opponent and a copy of the registration certificate shows A as owner of the earlier mark, the opposition will be rejected as not substantiated, unless the opponent has provided evidence of the transfer and, if

already available, the registration of the transfer in the relevant register or the opponent has shown that A and B are the same legal entity, which has merely changed its name.

If the opponent is a licensee of the trade mark proprietor, the extract of the registration will normally show when a licence has been registered. However, some Member States do not record licences in their registers. In all cases, it is up to the opponent to demonstrate that it is a licensee and also that it is authorised by the trade mark owner to file an opposition. There are no restrictions on what evidence can be submitted to support such an authorisation: for example, any express authorisation on behalf of the trade mark proprietor, such as the licence contract, is deemed sufficient, so long as it contains indications concerning the authorisation or entitlement to file the opposition.

The same applies to persons authorised under the relevant applicable national law for the ground of Article 8(4) CTMR. The opponent has the burden of showing its entitlement to file the opposition under the applicable national law.

According to Article 22 CTMR and Rules 33, 34 and 35 CTMIR, the Office registers and publishes licence agreements in respect of Community trade marks. If the earlier mark basis of the opposition subject to the licence agreement is a CTM, the opponent does not have to submit any evidence of the licence contract as long as the licence has been registered and published at the Office according to Article 22 CTMR. On the other hand, the opponent will still have to submit evidence that proves that this licence agreement entitles it to act in defence of the mark if the licence is registered and published at the Office, if this evidence was not attached to the original request filed according to Article 22(5) CTMR. For more information of licences, see the Guidelines, Part E, Register Operations, Section 3, CTMs as Objects of Property, Chapter 2, Licences. It is not sufficient to prove the registration of the licence agreement — the opponent's entitlement to defend the CTM must also be submitted in writing.

4.2.4 Substantiation of well-known marks, claims of reputation, trade marks filed by an agent, earlier signs used in the course of trade

4.2.4.1 Well known marks

Article 8(2) CTMR Rule 19(2)(b) CTMIR
--

An earlier well known mark is a trade mark that is well known in a Member State, in the sense in which the words 'well known' are used in Article 6*bis* of the Paris Convention. Such a mark may be unregistered, but it may also be registered.

The opponent needs to demonstrate that it is the owner of an earlier trade mark that has become well known in the relevant territory, for the goods and services on which the opposition is based. In order to substantiate its mark it will have to submit evidence of the mark being well known.

If the opponent invokes a registered trade mark and claims the same mark in the same country as a well known mark, this will in general be taken as a claim that its registered mark has acquired a high degree of distinctiveness by use.

It is very common for opponents to confuse 'well known' marks with 'marks with a reputation' under Article 8(5) CTMR. Depending on the ground of opposition that is indicated, the case will have to be considered under Article 8(2) and/or Article 8(5)

CTMR. See also the Guidelines, Part C, Opposition, Section 5, Trade Marks with Reputation Article 8(5) CTMR.

4.2.4.2 Marks with reputation

Article 8(5) CTMR
Rule 19(2)(c) CTMIR

An opposition under Article 8(5) CTMR is based on an earlier trade mark that has a reputation. See also the Guidelines, Part C, Opposition, Section 5, Trade Marks with Reputation Article 8(5) CTMR.

The earlier trade mark in these cases is a registered trade mark. The opponent therefore has to submit registration certificates, etc. as set out above.

In order to make its case under Article 8(5) CTMR, the opponent has to submit evidence of reputation. In addition, the opponent has to allege and demonstrate that the use of the mark that is the subject-matter of the contested CTM application would take unfair advantage of, or be detrimental to, the distinctive character or the repute of the earlier trade mark or to indicate that this is probable in the ordinary course of events.

4.2.4.3 Non-registered trade mark or another sign used in the course of trade

Article 8(4) CTMR
Rule 19(2)(d) CTMIR

For these rights the Office applies the protection provided by the relevant law.

Not all Article 8(4) CTMR rights are unregistered, e.g. in some countries company and commercial names are registered. If it is a matter of a registered right, then copies of the registration and renewal certificates, etc. are required, as set out above for trade mark registrations. In the case of unregistered marks or signs the opponent must provide evidence of the acquisition of the earlier right. It must further show that it may prohibit the use of a subsequent trade mark.

The opponent must submit evidence that its use of its sign (earlier right, either registered or not) has been of more than local significance. Furthermore, it also needs to provide the wording of the provisions of the national law on which it bases its case and make out its case under this law. See in detail the Guidelines, Part C, Opposition, Section 4, Rights under Article 8(4) CTMR.

4.2.4.4 Mark filed by an agent or representative

Article 8(3) CTMR
Rule 19(2)(e) CTMIR

This concerns the case where an agent or representative of the proprietor of a trade mark applies for its registration at the Office. The proprietor can oppose the application

of the disloyal applicant. See also the Guidelines, Part C, Opposition, Section 3, Unauthorised Filing by Agents of the TM Proprietor (Article 8(3) CTMR).

The opponent has to prove its ownership of the trade mark and the time of acquisition of that mark. As the trade mark can be either a registered trade mark or an unregistered trade mark, the opponent will have to submit evidence of registration anywhere in the world or evidence of acquisition of rights through use. The opponent also has to submit evidence of an agent-representative relationship.

4.2.5 Sanction

Rule 20(1) CTMIR

To the extent that the invoked earlier rights have not been substantiated, the opposition will be refused as unfounded. When the evidence check reveals that none of the earlier rights on which the opposition is based has been substantiated, i.e. the opponent has not provided sufficient evidence to prove that it owns a valid earlier right, the whole opposition must be rejected immediately after expiry of the two-month substantiation time limit, without waiting for the applicant's reply.

In no case is the Office required to inform the parties which facts or evidence could be or have not been submitted. This will be detailed in the final decision, which can be appealed.

4.3 Translation/changes of language during the opposition proceedings

Most submissions of the parties in opposition proceedings have to be in the language of the proceedings in order to be taken into account. For different submissions there are different rules to be applied.

The general rule is Rule 96 CTMIR. Rule 96(1) CTMIR applies to written statements/submissions filed within the opposition procedure. Rule 96(2) CTMIR applies to evidence attached to a written submission filed within the opposition procedure. However, Rule 96 CTMIR does not apply if there is a *lex specialis*. Rule 19(3) CTMIR for facts, evidence and arguments submitted by the opponent and Rule 22(6) CTMIR for evidence of use (always submitted by the opponent) are examples of such a *lex specialis*.

4.3.1 Translations of evidence of trade mark registrations and of facts, evidence and arguments submitted by the opponent to complete its file

Rules 19(3) and (4), 20(1) and 98(1) CTMIR
--

The Office can only consider evidence that is submitted in the language of the opposition proceedings within the time limit specified for submitting the original document. Rule 19(3) CTMIR is a *lex specialis* to any other rule on the language regime.

Therefore, both the evidence submitted by the opponent for the first time at the end of the time limit for substantiation of the opposition, as well as any other previously submitted document or certificate, must be either in the language of the proceedings, or be accompanied by a translation. Only what is submitted and translated within this time limit is taken into account. If no translation or an insufficient translation has been submitted, the opposition will be partially or entirely rejected as unfounded.

Rule 98(1) CTMIR requires that the translation reproduces the structure and contents of the original document.

Therefore, the principle is that the entire document must be translated and follow the structure of the original document.

The Office does not consider that information already given in the language of the proceedings in the notice of opposition, or in documents attached thereto or submitted later (e.g. explanation of grounds, lists of earlier marks etc.) amounts to a valid translation of a registration document, such as a registration certificate, even where such indications have been accepted for admissibility purposes. The translation has to be on a stand-alone basis and cannot be assembled from fragments taken from other documents.

Extracts from commercial databases cannot be considered valid translations of an official document, unless they reproduce the structure and contents of the original document.

The Office accepts that no translation of the information headers in the extracts/certificates (such as, 'filing date' 'colour claim', etc.) is needed, provided that they are also identified using standard INID codes or national codes.

The list of INID codes and their explanations are attached as Appendix 1 to Standard ST 60 ('Recommendation concerning bibliographic data relating to marks'), available on WIPO's website.

Only irrelevant administrative indications (e.g. previous transfers of ownership that do not affect the opposition, administrative entries on fees, etc.) with no bearing on the case may be omitted from the translation (judgment of 29/09/2011, T-479/08, Shoe with two stripes, EU:T:2011:549).

Where the opposition is based on only some of the goods and services covered by the earlier right, it is sufficient to provide a translation of only the goods and services on which the opposition is based.

When the entire original document is in the language of the proceedings except for the list of goods and services, there will be no need to provide a complete translation following the structure of the original document. In this case, it is acceptable if only the goods and services on which the opposition is based have been translated separately in the notice of opposition, or in documents attached thereto or submitted later within the time limit to substantiate the opposition. The same applies to extracts/certificates that make use of INID or national codes, where the only information that still needs to be translated into the language of the proceedings is the list of goods and services.

Rule 98(1) CTMIR

The Office accepts simple translations, drawn up by anybody. The Office normally does not make use of its faculty to require the translation to be certified by a sworn or official translator unless serious doubts arise regarding the accuracy or content of the translation. Where the representative adds a declaration that the translation is true to the original, the Office will, in principle, not question this. The Office even accepts handwritten text on the copies of the original certificates giving the meaning of the various entries in the language of the proceedings, provided of course that they are complete and legible.

The Office does not oblige the opponent to provide translations of the evidence depending on the applicant's reaction because Rule 19(3) CTMIR does not provide for any exception to the principle that the evidence needs to be translated.

4.3.1.1 Sanction

Rules 19(3), 19(4) and 20(1) CTMIR

If the submissions are not in the language of the proceedings, they must be translated within the time limit specified for submitting the original document.

If this is not done, the legal consequence is that documents that have not been translated in this time limit are not taken into account. However, if documents proving the existence and validity of the earlier right have not been translated, the opposition must be refused as unfounded straight away.

4.3.2 Translation of further observations

Rules 20(2) and (4), and 96(1) CTMIR

There is no special rule for translations of the applicant's first reply or other observations drawn up by the applicant or opponent at a later stage in the proceedings. Consequently, for these submissions Rule 96(1) CTMIR applies. This means that the applicant's first reply or the opponent's reply to the applicant's observations may be in any language of the Office.

It is to be noted that if the applicant's first reply or the opponent's counter reply is not in the language of proceedings but in one of the languages of the Office, the submission will not be taken into account unless the applicant or the opponent submits a translation of these documents in the language of the proceedings within the time limit of one month from the date of receipt of the original by the Office. The Office will not request the parties to send a translation; the parties have to send one on their own initiative.

Example 1

The language of opposition is English and the applicant has until 26/06/2012 to submit observations in reply to the notice of opposition. If, on 20/06/2012, it submits its observations in reply to the opposition in German, it must file its translation by

20/07/2012. If it then files the translation on or before 20/07/2012, both the original submission and the translation must be taken into account, notwithstanding that the original time limit for filing observations expired on 26/06/2012.

Example 2

The language of opposition is English and the applicant has until 26/06/2012 to submit observations in reply to the notice of opposition. If, on 18/05/2012, it submits its observations in reply to the opposition in German, it must file its translation by 18/06/2012. However, as its time limit only finishes on 26/06/2012, if it has not filed a translation by 18/06/2012, it can still validly file documents until 26/06/2012. If it then files the translations before the end of the time limit, the Office considers the translation as valid observations filed in the language of the proceedings within the set time limit.

Rule 98(2) CTMIR

If no translation has been submitted, the observations are deemed not to have been received by the Office and they will not be taken into account.

4.3.3 Translation of documents other than observations

Rules 96(2) and 98(2) CTMIR

All evidence, with the exception of the evidence that the opponent must provide within the time limit given to substantiate its opposition, can be submitted in any official language of the Community, as Rule 96(2) CTMIR applies. This evidence concerns all documents, other than observations, submitted by the parties after the time limit for the opponent to complete its file.

Examples of this type of evidence are catalogues, magazine articles, decisions of national courts or signed agreements that are submitted by the applicant together with its observations in reply to the opposition.

For this evidence, a translation is needed only if the Office requests it. Therefore, the parties are not automatically obliged to file a translation.

The Office exercises its discretion as follows (this practice corresponds *mutatis mutandis* to that concerning evidence of use).

In principle, the Office does not *ex officio* require a translation. However, it is vital that the party to whom the documents are addressed should be able to understand the meaning of their substantive content. If this is doubtful or contested by the party addressed, the Office requires a translation within a specified time limit.

Rule 98(2) will apply only if the Office requires a translation, with the effect that translations that are filed late must be disregarded; likewise the original for which a translation is late or missing must also be disregarded.

Together with the invitation to file a translation, the Office will draw the attention of the party concerned to the fact that it is up to that party to evaluate whether a complete translation of all the evidence submitted may be necessary. However, the documents in

question will only be taken into account insofar as a translation is submitted or insofar as the documents are self-explanatory, regardless of their word components.

Example

In the case of a national court decision it may be sufficient to translate only those parts that are relevant for the opposition proceedings.

4.3.4 Proof of use

Rule 22(2) and (6) CTMIR

For proof of use, Rule 22(6) CTMIR is *lex specialis* as regards translations. If the evidence is submitted in an EU language that is not the language of the proceedings, the Office may require the opponent to submit a translation of the evidence into the language of the proceedings within a specified time limit.

Therefore, it is at the Office's discretion whether or not to request a translation. In exercising this discretion, the Office balances the interests of both parties.

It is vital that the applicant should be able to understand the meaning of the substantive content of the evidence submitted. If this is doubtful or contested by the applicant, the Office may require a translation within a specified time limit. However, a rejection of such a request is feasible where it appears that the applicant's request, in view of the self-explanatory character of the submitted evidence, is exaggerated or even unjust.

For further information on proof of use, see the Guidelines, Part C, Opposition, Section 6, Proof of Use.

Rule 22(2) CTMIR has the effect that the opposition must be rejected if (1) no proof of use is submitted within the time limit given, or (2) proof of use was submitted within the time limit given but the Office requested it to be translated and no translation was submitted within the time limit set.

If the opponent provides evidence of use in a language other than the language of the proceedings within the time limit established and then on its own initiative submits a translation of this evidence into the language of the proceedings after the expiry of the time limit but before the time limit set for the applicant to submit observations in reply has expired, this evidence will be taken into account. This applies even if the Office has not required the opponent to file a translation and even if the applicant has not contested the evidence yet.

4.3.5 Change of language during opposition proceedings

Article 119(7) CTMR Rule 16(2) CTMIR

According to Article 119(7) CTMR, the parties to opposition proceedings may agree to change the procedural language and choose any official language of the European Union for that purpose.

Rule 16(2) CTMIR sets forth the conditions under which such a change of language may occur. It requires that the opposition be filed in a language of the Office at the outset. It states that the parties may agree to change the procedural language and are required to inform the Office accordingly prior to the expiry of the cooling-off period. A request to change the language after the expiry of the cooling-off period will not be accepted by the Office.

When the opponent and the applicant agree to change the language of the proceedings before the start of the adversarial part of the proceedings, Rule 16(2) CTMIR requires the opponent to 'file a translation of the notice of opposition in that language'. It has to do so within one month of expiry of the cooling-off period.

Where the translation is not filed or filed late, the language of the proceedings will remain unchanged.

4.4 Documents not readable/reference to other files

4.4.1 Documents not readable

Rule 80(2) CTMIR

Where a communication received by fax is incomplete or illegible, or where the Office has reasonable doubts as to the accuracy of the transmission, the Office will inform the sender accordingly and invite it, within a time limit to be specified by the Office, to retransmit the original by fax or to submit the original in accordance with Rule 79(a) CTMIR.

When this request is complied with within the time limit specified, the date of receipt of the retransmission is deemed to be the date of receipt of the original communication.

4.4.2 No return of original documents

Original documents become part of the file and therefore cannot be returned to the person who submitted them.

However, the party always has the possibility of obtaining a certified or uncertified copy of the original documents, subject to the payment of a fee. For further details, see information displayed on the Office's web page under 'Inspection of files and copies'.

4.4.3 Confidential information

Rule 88(c) CTMIR

In some cases one of the parties requests the Office to keep certain documents confidential even from the other party in the proceedings. Although the Office can keep documents confidential vis-à-vis third parties (inspection of files), it can under no circumstances keep documents confidential with regard to the other party in *inter partes* proceedings.

Each party to the proceedings must always have a right to defend itself. That means that it should have full access to all material submitted by the other party.

It follows that all material submitted by a party should be disclosed to the other party of the proceedings. The Office has an obligation to communicate all material received to the other party. Therefore, if one of the parties requests certain documents be kept confidential without mentioning whether this should be vis-à-vis third parties, the Office will take it for granted that this is the case and will forward them to the other party and mark them as confidential in the electronic file.

If in the course of opposition proceedings the Office receives documents with a request that they be kept confidential *inter partes*, the sender should be informed that the documents cannot be kept confidential with respect to the other party to the proceedings.

To this end, a letter has to be sent, clearly explaining that the sender may choose between disclosure of the documents or withdrawal of the documents. It is up to the party to decide which of these possibilities is appropriate for its case and inform the Office accordingly.

If it confirms confidentiality, the documents will not be sent to the other party and will not be taken into account. They will be marked as confidential in the electronic file.

If it wants the documents to be taken into account but not available for third parties, the documents can be forwarded to the other party, but must be marked confidential in the electronic file.

If it does not reply within the time limit specified, the documents will not be sent to the other party and will not be taken into account. They will be marked as confidential in the electronic file.

4.4.4 References made to documents or items of evidence in other proceedings

Rule 79(a) and Rule 91 CTMIR Decision EX-13-4 of the President of the Office

The Office may receive observations from the opponent or applicant in which they refer to documents or evidence submitted in other proceedings, for instance to evidence of use that has already been submitted in a different opposition.

Such requests are accepted at any stage of the proceedings when the opponent/applicant clearly identifies the documents that it refers to. The party must indicate the following: (1) the number of the opposition it refers to; (2) the title of the document it refers to; (3) the number of pages of this document; and (4) the date this document was sent to the Office; e.g. 'the statutory declaration that was submitted to the Office on dd/mm/yy in opposition proceedings B XXX XXX, together with exhibits 1 to 8, consisting of XX pages'.

Should the documents referred to by the opponent or the applicant consist originally of items of evidence not having been filed in paper format up to and including A3 size and should this evidence not be available in the electronic file of the Office, in accordance with Rule 79a CTMIR the party concerned must submit by mail a second copy for

transmission to the other party within the original time limit. If no copy is provided, these items of evidence will not be taken into account.

In addition, it should be noted that the documents or evidence referred to might need translation into the language of the opposition proceedings. Rules 19(4) and 22(6), and Rule 96 CTMIR apply accordingly.

A general reference to documents or evidence submitted in other proceedings will not be accepted. In such a situation the party making general reference to other documents or evidence may be invited to be sufficiently specific within a given time limit. The party should be informed that the time limit granted by the Office is only meant for the clear and precise indication of the documents or evidence referred to and that under no circumstances will an extension of the original time limit be granted. Moreover, the party should also be informed that if it does not specify which documents are being referred to within the time limit set, those other documents will not be considered.

The parties should be aware that material submitted in other proceedings may have been destroyed five years after their receipt in accordance with Rule 91 CTMIR and Decision EX-13-4 of the President of the Office of 26 November 2013 concerning the keeping of files. In this case, the reference to documents or evidence submitted in other opposition proceedings has no effect.

4.5 Further exchanges

Rules 20(2), (4) and (6), 22(5), 96(2) and 98(2) CTMIR
--

The Office invites the applicant to file observations within the time limit set by it in accordance with Rule 20(2) CTMIR.

In appropriate cases, the Office may invite the parties to limit their observations to particular issues. In that case, the party is allowed to raise the other issues at a later stage of the proceedings. For example, the applicant can request proof of use of the earlier right with or without submitting observations at the same time on the grounds on which the opposition is based. In that case, the observations may be submitted together with the observations in reply to the proof of use.

Once the applicant has submitted its observations in reply, the opponent is granted a final time limit to submit its counter reply if the Office considers it necessary. After this, the adversarial part of the proceedings is usually closed and the opposition is ready for decision.

The Office may, however, grant the possibility of another exchange of observations. This can be when the case deals with complex issues or when the opponent raises a new point that is admitted to the proceedings. In this case the applicant must be given a possibility of replying. It is at the discretion of the Office to decide if another round of observations should be granted to the opponent.

Therefore, a further exchange of observations may only be granted where the opponent's final observations are purely in reply to the applicant's observations and are supported by evidence that is not meant to remedy flaws such as those related to substantiation, e.g. if the applicant raises new issues such as the coexistence of the marks, the invalidity of the earlier right or an agreement between parties. If the

opponent submits evidence to the contrary, the applicant may be granted a second chance to submit further observations. Nevertheless, this is not automatic as it depends on the circumstances of the case.

4.5.1 Additional evidence for proof of use

The Office may take into account additional evidence for proof of use that is submitted after the expiry of the corresponding time limit under certain circumstances, namely where the opponent submitted relevant evidence within the time limit and the additional evidence is only supplementary (judgment of 18/07/2013, C-621/11 P, Fishbone, EU:C:2013:484, § 28-30). Additional evidence will be examined on a case-by-case basis. If necessary, a second round of observations will be granted. For further details, see the Guidelines, Part C, Opposition, Section 6, Proof of Use.

4.6 Observations by third parties

Article 40 CTMR Communication 2/09 of the President of the Office
--

Third parties can make observations explaining why the CTM application should not be registered based on one of the absolute grounds of Article 7 CTMR. For further details, see the Guidelines, Part B, Examination, Section 4, Absolute Grounds for Refusal and Collective Marks, and the Guidelines, Part B, Examination, Section 1, Proceedings.

Anybody can submit third party observations; even the opponent is entitled to do so. However, it should do so in a manner that leaves no doubt that they are third party observations. According to the abovementioned Communication of the President of the Office, the observations must be submitted separately. However, in practice (decision of 30/11/2004, R 0735/2000-2, SERIE A), the 'separate submission' requirement is deemed to be satisfied when the observations are clearly separable from the grounds and arguments supporting the opposition, even if they are included in the same document. As long as the opponent expressly mentions that it wishes to make observations under Article 40 CTMR, these will be dealt with, even if they are not submitted separately. However, if in its submission the opponent argues that the CTM application should have been refused under Article 7 CTMR, without any reference to the contents of Article 40 CTMR, this submission will not be regarded as third party observations under Article 40 CTMR.

When an opponent makes third party observations, the Office will consider if the observations raise serious doubts as to the registrability of the CTM application, or if they will only be sent to the applicant for information purposes.

If the observations raise serious doubts, the Office must suspend the opposition proceedings until a decision on the observations is taken. In cases where the observations do not raise serious doubts (i.e. when the observations have only been sent to the applicant for information purposes) or do not affect the contested goods or services, the opposition proceedings will not be suspended. If the opposition proceedings need to be suspended, the suspension will take effect from the date when the Office issues the objection under Article 7, and proceedings will remain suspended until a final decision has been taken. For cases where the third party observations are received within the three-month opposition period, the Office will deal with the

admissibility of the opposition and, once the decision on admissibility has been notified, the opposition proceedings will be suspended.

For oppositions closed due to third party observations, the opposition fee will not be refunded, as such refund is not foreseen in the regulations (see Rule 18(5) CTMIR).

5 Termination of Proceedings

5.1 Friendly settlement

Article 42(4) CTMR
Rule 18(2) CTMIR

The parties are free to decide on the measure that brings the opposition proceedings to conclusion. While they can decide on the withdrawal of the opposition, they can also simply ask the Office to close the case without giving specific reasons. It suffices to communicate the written signed agreement of the parties, which does not have to include a statement of grounds. The Office then takes the steps needed to close the proceedings on the basis of this agreement.

Regarding the refund of fees and decision on costs in case of friendly settlement, please see the relevant paragraph below.

The Office may, if it thinks fit, invite the parties to make a friendly settlement. The Office, as well as the parties, may therefore initiate a settlement procedure.

To this end it may issue proposals for friendly settlement. As, in principle, the Office cannot (and does not wish to) replace the parties, it will only take action in very rare cases where a settlement between the parties appears desirable and if there are good reasons for considering that the proceedings can be ended by a settlement.

If expressly requested by the parties, the Office can also offer assistance with their negotiations, for instance by acting as an intermediary or by providing them with any material resources that they need. Any costs incurred are borne by the parties. Friendly settlement may be preceded by a request for suspension.

5.2 Restrictions and withdrawals

Articles 58(1), 64(3) and Article 85 CTMR
Rules 18(2), (3) and (4), 95(a) and 96(1) CTMIR

5.2.1 Restrictions and withdrawals of CTM applications

Article 43 CTMR
Rule 18(5) CTMIR

It is possible for the applicant to restrict the goods and services of its application or to withdraw the entire application at any stage of the opposition proceedings.

Withdrawals and restrictions must be explicit and unconditional. Silence on the part of the CTM applicant during the proceedings will never be considered as a tacit withdrawal.

A conditional or ambiguous withdrawal or restriction will not be accepted and will be forwarded to the other party merely for information purposes, informing the parties that it will not be taken into account.

The Office does not accept restrictions that are conditional. For example, the applicant argues in its observations in reply to the opposition that the signs are dissimilar. However, the applicant adds that if the examiner finds them similar, it will restrict the list of goods and services of the CTM application. In this case the restriction is not acceptable, and the applicant must be informed that the restriction must be express and unconditional.

For further information on restrictions of a CTM application, see the Guidelines, Part B, Examination, Section 3, Classification and Part B, Examination, Section 1, Proceedings, paragraph 5.2.

If the restriction is not acceptable the applicant must be notified.

If a restriction is partly acceptable and partly unacceptable (see the Guidelines, Part B, Section 3, Classification for further information on what constitutes an acceptable amendment), the Office will proceed with the restriction for the acceptable part and will inform the applicant of the part that cannot be accepted, giving a time limit of two months to react. The opponent must be sent a copy of the restriction and the reply of the Office to the applicant. If within the two months the applicant reacts with a new proposal for the unacceptable part of the restriction, which the Office can now accept, the restriction will be processed taking into account the date of filing of the first request for the restriction. On the other hand, if the applicant does not react, the restriction is only processed insofar as it is acceptable (judgment of 11/12/2014, C-31/14 P, Premeno, EU:C:2014:2436, § 43-51).

If the opponent withdraws its opposition after an unacceptable restriction has been filed, the withdrawal will not be taken into account if it clearly refers to the unacceptable restriction. Once the restriction has become acceptable, the opponent will be informed of the new list of goods and services and will be granted a new time limit to confirm the withdrawal of the opposition.

If the restriction is acceptable, a confirmation is sent to the applicant.

Depending on the moment in the proceedings, the restriction or withdrawal has different consequences, described below.

5.2.1.1 Withdrawal or restriction before the admissibility check is made

Restriction covers the whole extent of opposition/withdrawal

When the CTM application is withdrawn or restricted to non-contested goods and services before notification of admissibility of the opposition, the opposition proceedings are closed and the opposition fee is refunded. In other words dealing with the withdrawal or restriction in these cases has priority over the admissibility.

No decision on costs will be taken.

Restriction does not (seem to) cover the whole extent of the opposition

In the case of a restriction that may still include contested goods and services, an admissibility check is done.

The restriction is notified to the opponent together with the notification of the admissibility or with the communication informing the opponent of an absolute or relative admissibility deficiency.

If the opposition is withdrawn, the opposition fee is refunded. This is the case even if irremediable deficiencies exist.

The opponent's letter does not have to make an express reference to the restriction, as long as it is later in time than the applicant's restriction.

No decision on costs will be taken.

5.2.1.2 Restrictions and withdrawals of CTM applications before the end of the cooling-off period

Restriction covers the whole extent of the opposition/withdrawal

If it is absolutely clear that the restriction covers the whole extent of the opposition or when the CTM application is withdrawn, this is notified to the parties and the proceedings are closed. The opponent is refunded the opposition fee.

No decision on costs will be taken.

Restriction does not (seem to) cover the whole extent of opposition/withdrawal

If it is not completely clear that the restriction covers the whole extent of the opposition or the restriction does not cover the whole extent of the opposition, the opponent is invited to inform the Office whether it wishes to maintain or withdraw its opposition. The parties are notified of its reply. If the opposition is withdrawn, the opposition fee is refunded to the opponent.

No decision on costs will be taken.

The relevant time to assess whether the opposition proceeding is closed during the cooling-off period is the date a request for restriction was filed before the Office.

If the withdrawal of the opposition is received by the Office before the official notification of the restriction is copied to the opponent, the withdrawal is considered to be a consequence of the restriction and the opposition fee is also refunded.

The opponent's letter does not have to make an express reference to the restriction, as long as it is later in time than the applicant's restriction.

The initial reaction of the opponent to the notification does not matter, as long as the withdrawal is declared later.

Examples

- The opponent does not reply within the time limit given to it but subsequently withdraws its opposition within the cooling-off period (which has been extended).
- The opponent responds by maintaining its opposition, but nevertheless withdraws the opposition still within the extended cooling-off period.

5.2.1.3 Restrictions and withdrawals of CTM applications after the end of the cooling-off period

Restriction covers the whole extent of the opposition/withdrawal

If it is absolutely clear that the restriction covers the whole extent of the opposition, the case is closed by the Office and the parties will be notified. At the same time the restriction is forwarded to the opponent.

Unless the parties submit an agreement on costs, the Office will take a decision on costs. For information on the apportionment of costs, see paragraph 5.5.3 of these Guidelines.

Restriction does not (seem to) cover the whole extent of opposition/withdrawal

If it is not completely clear that the restriction covers the whole extent of the opposition or the restriction does not cover the whole extent of the opposition, the opponent is invited to inform the Office whether it wishes to maintain or withdraw its opposition. The parties are notified of any reply. If the opposition is maintained, the proceedings continue. If the opposition is withdrawn, the opposition proceedings are closed. If the opponent first maintains its opposition and then subsequently withdraws, this is treated as a withdrawal of the opposition in accordance with paragraph 5.2.2.2 below.

Unless the parties submit an agreement on costs, the Office will take a decision on costs. For information on the apportionment of costs, see paragraph 5.5.3 below.

5.2.1.4 Restrictions and withdrawals of CTM applications after a decision has been taken

Following the decision of the Grand Board of Appeal of 27/09/2006 in case R 0331/2006-G, Optima, the Office accepts withdrawals and restrictions received during the appeal period after a decision on the opposition has been rendered, even if no appeal has been filed. However, the withdrawal or restriction will not have any effect on the decision, which remains valid.

This means that the Office will take note of the withdrawal and close the case. Confirmation of the withdrawal is sent to the parties (however, no decision on costs is included in this communication). The part on costs of the initial decision remains valid and can be enforced by the winning party. The Office's database is updated accordingly to reflect the withdrawal of the CTM application.

For further information, see the Guidelines, Part B, Examination, Section 1, Proceedings and the Guidelines, Part E, Register Operations, Section 2, Conversion.

A CTM application cannot be withdrawn once a decision rejecting the CTM application in full has become final, i.e. after the two month period for appeal.

If the decision rejected the opposition, the application can be withdrawn or restricted at any time.

5.2.1.5 Language

Rule 95(a) CTMIR

During opposition proceedings a restriction may be submitted either in the first or the second language of the CTM application.

When the restriction is submitted in the first language of the CTM application, which is not the language of proceedings, and when the restriction does not cover the whole extent of the opposition, the restriction is forwarded to the opponent, requesting it to inform the Office whether or not it maintains its opposition. The opponent can object to the language of the restriction and ask for a translation into the language of proceedings. The Office will then provide for the translation.

If an acceptable restriction is submitted in the first and the second language, the examiner must reflect this restriction in the two languages in the Office's database and confirm the new list of goods and services in the two languages to the applicant.

5.2.2 Withdrawal of oppositions

The opponent can withdraw its opposition at any time during the proceedings.

A withdrawal of the opposition must be explicit and unconditional. A conditional or ambiguous withdrawal will not be accepted and will be forwarded to the applicant merely for information purposes, informing the parties that it will not be taken into account.

If the opponent withdraws its opposition independent of any restriction of the CTM application, three situations can arise depending on the status of the opposition (for information about the consequences of the withdrawal of an opposition following a restriction of the CTM application, see paragraph 5.2.1 above.)

5.2.2.1 Withdrawal of the opposition before the end of the cooling-off period

If the opposition is withdrawn before the end of the cooling-off period the parties are notified. Unlike a withdrawal of the opposition following a restriction of the CTM application during the cooling-off period (see paragraph 5.2.1.2 above), the Office neither refunds the opposition fee nor takes a decision on costs.

5.2.2.2 Withdrawal of the opposition after the end of the cooling-off period

If the opposition is withdrawn after the end of the cooling-off period the parties are notified. The opposition fee is not refunded. Unless the parties submit an agreement on

costs, the Office will take a decision on costs. For information on the apportionment of costs, see paragraph 5.5.3 below.

5.2.2.3 Withdrawal of the opposition after a decision has been taken

Following decision of the Grand Board of Appeal of 27/09/2006 in case R 0331/2006-G, Optima, the Office accepts withdrawals of the opposition received during the appeal period after a decision on the opposition has been taken, even if no appeal has been filed. However, the withdrawal will not have any effect on the decision, which remains valid.

This means that the Office will take note of the withdrawal and close the case. Confirmation of the withdrawal is sent to the parties (however, there is no decision on costs included in this communication). The part on costs of the initial decision remains valid and can be enforced by the winning party. The database of the Office is updated accordingly to reflect the withdrawal of the opposition and the application is sent to registration.

For further information on withdrawals during appeal proceedings, see the Guidelines, Part B, Examination, Section 1, Proceedings, paragraph 5.1.

5.2.2.4 Language

Rule 96(1) CTMIR

A withdrawal of the opposition must be in the language of the proceedings. Should the withdrawal be submitted in a language that is not the language of proceedings a translation must be filed within one month from the date of submission of the original document. Otherwise the withdrawal will be refused.

5.2.3 Withdrawals of withdrawals/restrictions

A party is only permitted to withdraw a previously submitted withdrawal/restriction if the Office receives its letter withdrawing the earlier withdrawal/restriction on the same day as the first submission.

5.3 Decision on substance

The decision on substance is taken once all the required submissions of the parties have been filed. It should deal only with those issues or earlier rights that are relevant for the outcome.

There are two exceptions:

- earlier right not proven;
- ceasing of existence of the earlier right.

5.3.1 Earlier right not proven

Rule 20(1) CTMIR

If proof of existence and validity has not been filed properly for any of the earlier rights invoked, the opposition is rejected as soon as the time limit given to the opponent to complete its file has expired.

However, if the existence and validity of at least one earlier right has been proven, the proceedings will continue normally, and the non-substantiated rights will not be taken into account in the final decision on substance.

5.3.2 Ceasing of existence of the earlier right

If, in the course of the proceedings, the earlier right ceases to exist (e.g. because it has been declared invalid, or it has not been renewed), the final decision cannot be based on it. The opposition may only be upheld with respect to an earlier right that is valid at the moment when the decision is taken. The reason why the earlier right ceases to have effect does not matter. Since the CTMA and the earlier right that has ceased to have effect cannot coexist anymore the opposition cannot be upheld to this extent. Such a decision would be unlawful (judgment of 13/09/2006, T-191/04, Metro, EU:T:2006:254, § 33-36).

Invalidation of any earlier right other than a CTM cannot be detected by the Office. However, if one of the parties informs the Office that this is the case, the other party must be heard, and eventually, the opposition will not be able to proceed on the basis of that earlier right.

Before the decision is taken, the Office will check whether the earlier right invoked has become due for renewal in the meantime. If so, the Office will invite the opponent to prove the renewal of the mark. This is the case even if the mark is still within the grace period for renewal, if applicable. If the opponent does not submit the proof, the opposition will not be able to proceed on the basis of that earlier right.

Before the decision is taken, the Office may also check the documents on file to see whether the earlier right invoked is the subject of national post-registration proceedings. If so, the Office will invite the opponent to provide evidence of the final outcome of the national proceedings. If the opponent provides evidence showing that the national proceedings are still pending, the Office may suspend the opposition proceedings until a final decision has been taken in the proceedings that led to the suspension.

5.4 Fee refund

5.4.1 Opposition deemed not entered

Article 41(3) CTMR
Article 9(1) CTMFR
Rule 17(1) CTMIR

If an opposition is deemed as not entered because of late or insufficient payment (see paragraph 2.2.2 above, Time of payment), the opposition fee, including any surcharge, must be refunded to the opponent.

5.4.1.1 Opposition and withdrawal of the opposition filed the same date

In cases where the opposition is withdrawn the same day it was filed, the Office refunds the opposition fee.

5.4.1.2 Refund after republication

If after republication of the CTM application in part A.2 of the Bulletin due to a mistake by the Office, a 'first publication opponent' wishes to withdraw its opposition as a consequence of the republication, the proceedings should be closed. As the Office made a mistake with the first publication, the opposition fee will be reimbursed.

5.4.2 Refund in view of withdrawals/restrictions of CTM application

5.4.2.1 CTM application withdrawn/restricted before the end of the cooling-off period

Rule 18(2), (4), (5) CTMIR

If the applicant withdraws its CTM application or withdraws all those goods and services against which the opposition is directed before or during the cooling-off period, the opposition proceedings are closed, there is no decision on costs and the opposition fee must be refunded.

5.4.2.2 Opposition withdrawn due to restriction of CTM application within the cooling-off period

Rule 18(3), (4), (5) CTMIR

If the applicant withdraws some of the goods and services against which the opposition is directed during the cooling-off period, the Office invites the opponent to state whether it maintains the opposition (and, if yes, against which of the remaining goods and services,) or if it withdraws it in view of the restriction.

If the opposition is then withdrawn, the opposition proceedings are closed, there is no decision on costs and the opposition fee must be refunded.

5.4.3 Multiple oppositions and refund of 50 % of the opposition fee

Rule 21(4) CTMIR

In certain special cases concerning multiple oppositions, it is possible to refund 50 % of the opposition fee to an opponent. Two conditions must be met:

- one of the opposition proceedings was terminated by the rejection of the contested CTM application in parallel opposition proceedings. For example, if there are four oppositions A, B, C and D (opponents A, B, C, D) against CTM application X, and CTM application X is rejected due to opposition A, and
- the other oppositions (B, C and D) had been suspended at an early stage of the proceedings (i.e. before the expiry of the cooling-off period) because a preliminary examination revealed that CTM application X would probably be rejected in its entirety because of opposition A.

In this case, opponents B, C and D are refunded 50 % of the opposition fee.

5.4.4 Cases where the opposition fee is not refunded

5.4.4.1 Opposition withdrawn before the end of the cooling-off period NOT due to a restriction

Rule 18(3), (4), (5) CTMIR

If the opponent withdraws its opposition before the end of the cooling-off period and there has been no restriction of the CTM application, the Office neither refunds the opposition fee nor takes a decision on costs.

5.4.4.2 Opponent's withdrawal is earlier

Rule 18(3), (5) CTMIR

When the opposition is withdrawn before the applicant restricts its application, the fee is not refunded. For example, if the applicant withdraws its application following (as a reaction to) the withdrawal of the opposition, the fee is not refunded, as this is the opposite situation.

The same applies when the applicant restricts the application following a partial withdrawal of the opposition.

5.4.4.3 Settlement between the parties before commencement of proceedings

Rule 18(2), (4), (5) CTMIR

As regards the refund of the opposition fee, Rule 18(5) CTMIR only mentions this possibility if there is either a withdrawal or a restriction of the CTM application.

Therefore, if the proceedings end by an agreement that contains a mention of a withdrawal or restriction of the CTM application, the opposition fee is refunded. In the other cases, the opposition fee is not refunded.

5.4.4.4 Termination of proceedings for other reasons

Articles 7, 40 and Article 92(2) CTMR
Rules 17, 18 and Rule 76(1), (4) CTMIR

In cases where the application is rejected in accordance with:

- Article 7 CTMR (rejection of an application on absolute grounds; on the Office's own initiative or because of third party observations)
- Article 92(2) CTMR (representation for non-EU applicants) and
- Rule 76(4) CTMIR (authorisations when expressly asked for by one of the parties),

the opposition fee is not refunded as none of these situations is contemplated in the CTMIR as a reason for refunding the opposition fee.

5.4.4.5 Reaction on disclaimer

Article 37(2) CTMR

If the applicant makes a disclaimer (disclaims an element of the opposed CTM application as being non-distinctive), and if thereafter the opponent withdraws the opposition, the opposition fee will not be refunded as this situation is not contemplated in the CTMIR as a reason for refunding the opposition fee. The disclaimer does not constitute a restriction of the list of goods and services of the CTM application.

5.5 Decision on the apportionment of costs

5.5.1 Cases in which a decision on costs must be taken

Article 85 CTMR
Rule 18(4) CTMIR

A decision on costs is taken in opposition proceedings that have passed the cooling-off period, i.e. where the adversarial part of the proceedings has started and come to an end.

If a decision on substance is taken, the decision on apportionment of costs is given at the end of the decision. In all other cases where the Opposition Division closes the case a decision on costs is issued together with the closure letters unless the parties have informed the Office about an agreement on costs.

5.5.2 Cases in which a decision on costs is not taken

No decision on costs is taken for oppositions that are closed before or during the cooling-off period.

5.5.2.1 Agreement on costs

Article 85(5) CTMR

Whenever the parties have settled the opposition proceedings with an agreement that includes the costs, the Office will not issue a decision on costs. The same is true if the Office receives information signed by both parties stating that the parties have agreed on costs. Such a request can also be sent in two separate letters to the Office. This information must be received before the Office has confirmed the closure of the proceedings.

If the parties settle the opposition by mutual agreement, they are free not to include the cost issue. If no indication is given as to whether the parties have agreed on the costs, the Office will take a decision on costs immediately, together with the confirmation of the withdrawal/restriction. If the parties inform the Office that they have reached an agreement on costs after the withdrawal/restriction, the decision already issued on costs will not be revised by the Office. It is left to the parties to respect the agreement and not to 'execute' the Office's decision on costs.

5.5.2.2 Information from potential 'successful party'

When the party that would be entitled to be awarded costs according to the general rules described in paragraph 5.5.3 below informs the Office that it accepts each party bearing their own costs, no decision on costs is necessary. The Office will refrain from taking a decision on costs whenever the potential 'successful party' informs the Office that it agrees to share the costs even if the 'losing party' does not confirm its agreement. The latest letters from both parties have therefore to be checked carefully before issuing a decision.

If, however, the losing party sends such a request to the Office, it will simply be forwarded to the other party, but the decision on costs will be taken *ex officio* under normal rules.

5.5.3 Standard cases of decisions on costs

Article 85(1), (2), (3) CTMR Rule 94 CTMIR

The general rule is that the party that terminates the proceedings, by withdrawing the CTM application (wholly or partially) or by withdrawing the opposition, will bear the fees incurred by the other party as well as all costs incurred by it that are essential to the proceedings.

If both parties lose in part, a 'different apportionment' has to be decided. As a general rule, it is equitable that each party bears its own costs.

A party that terminates the proceedings is deemed to have given in. The hypothetical outcome of the case if a decision on substance had become necessary is absolutely irrelevant.

In standard cases the result is the following.

- The applicant withdraws or restricts its application to the goods and services the opposition is not directed at (partial withdrawal). In these cases the applicant has to pay the costs.
- The opponent withdraws its opposition without any restriction of the CTM application as regards the contested goods and services after the cooling-off period. The opponent has to pay the costs.
- Restriction of the application followed by withdrawal of the opposition (judgment of 28/04/2004, T-124/02 and T-156/02, Vitataste, EU:T:2004:116, § 56). In principle each party bears its own costs.

A different apportionment of costs can however be justified for reasons of equity (for example, if the application was restricted only to a very small extent).

The Office will not take into account parties' arguments as to who should pay.

5.5.4 Cases that did not proceed to judgment

5.5.4.1 Multiple oppositions

Complete rejection of the CTM application

In cases where there are multiple oppositions against the same CTM application that have not been suspended by the Office in accordance with Rule 21(2) CTMIR, and one opposition leads to the rejection of the CTM application, the Office does not take any action in the other oppositions until the appeal period has elapsed.

If the appeal period elapses without an appeal being filed, the Office closes the other opposition proceedings and the cases do not proceed to judgment.

In this case, the determination of costs is at the discretion of the Opposition Division (Article 85(4) CTMR). The Office is not able to determine who the 'winning or losing party' is, and the applicant should not be required to pay the costs of several other opponents if it loses in one decision on substance. Therefore, applying a principle of equity, each party will be ordered to bear its own costs.

Partial rejection of the CTM application

In cases of multiple oppositions that are partially directed against the same goods and services of the contested trade mark, the decision in relation to the opposition that is taken first may affect the other oppositions.

Example

Opposition A is directed against Class 1 and opposition B against Classes 1 and 2 of the contested CTM application. A decision is taken first in opposition A rejecting the contested application for Class 1. When the decision is notified to the parties of opposition A, opposition B must be suspended until the decision in opposition A is final and binding. Once the decision is final, the opponent of opposition B will be invited to inform the Office whether it wishes to maintain or withdraw its opposition in view of the amendment of the list of goods. If the opponent withdraws the opposition, the case is closed.

In this situation, and if the case is closed after commencement of the adversarial part of the proceedings, the Office will issue a decision on costs in accordance with Article 85(2) CTMR. The opponent withdrew its opposition following the partial rejection of the contested trade mark. To this extent the opponent was successful in the proceedings. However, the partial rejection of the trade mark was more restricted than the scope of the opposition. To this extent the applicant/holder was also successful in the proceedings. Consequently, it is equitable that each party should bear its own costs.

If the opponent maintains its opposition after the partial rejection, the proceedings continue and in the final decision on the substance the decision on costs is taken according to the normal rules.

5.5.4.2 Rejection of an application on the basis of absolute grounds or formalities

A CTM application can be rejected during an opposition procedure on absolute grounds for refusal (either on the basis of third-party observations, Article 40 CTMR, or even *ex officio* if the case is re-opened) or on formalities (e.g. if an applicant from outside the EU is no longer represented under Article 92(2) CTMR).

Once the rejection becomes final, the opposition proceedings are closed by issuing a notification.

In these situations the practice on costs is as follows:

If the refusal becomes final after the expiry of the cooling-off period, a decision on costs is taken pursuant to Article 85(4) CTMR. If the same situation arises before commencement of the adversarial part, no decision on costs is to be taken.

5.5.4.3 Cases of joinder

Rule 21 CTMIR

For further information on joinder, see paragraph 6.4.3, Joinder of proceedings, below.

In cases where the joint opposition succeeds in its entirety the applicant should pay the opposition fees paid by each of the opponents but representation costs only once. If the applicant wins, its representation costs will be awarded once but each of the joint opponents will be liable for them. A different apportionment of costs might be equitable. In cases of partial success or if equitable for other reasons, each party should bear its own costs.

5.5.4.4 The meaning of 'bear one's own costs'

The notion of costs comprises the opposition fee and the costs essential to the proceedings, as referred to in Article 85(1) CTMR and Rule 94(6) and (7) CTMIR. In most cases the costs cover the remuneration of an agent within the limits of the scales set by the Regulation.

'Each party shall bear their own costs' means that no party has a claim against the other party.

5.6 Fixing of costs

Article 85(6) CTMR Rule 94 CTMIR

Where the costs are limited to representation costs and the opposition fee, the decision fixing the amount of costs will be included in the decision on the apportionment of the costs (i.e. as a rule, in the decision on substance).

This means that in the vast majority of cases, it will not be necessary to fix the amount of costs separately.

The only exceptions are:

- when an oral hearing took place;
- when the fixing of costs was inadvertently omitted ('forgotten') in the main decision.

5.6.1 Amounts to be reimbursed/fixed

Rule 94(3) and (6) CTMIR

The amount to be reimbursed is always fixed in EUR, regardless of the currency in which the party had to pay its representative.

If the opponent wins, the opposition fee of EUR 350 will be reimbursed.

As regards representation costs, the amount is limited to EUR 300. This applies both to the opponent and the applicant, provided that they were represented in the opposition procedure by a professional representative within the meaning of Article 93(1) CTMR, irrespective of whether these costs have actually been incurred. If the winning party was represented at some stage of the proceedings by a professional representative, but is no longer represented at the time of taking the decision on costs, it is also entitled to an award of costs regardless of when in the proceedings professional representation ceased.

Representation costs for employees, even from another company with economic connections, are not reimbursable and will not be fixed. They will not be addressed in the decision on costs.

For further information on representation, see the Guidelines, Part A, General Rules, Section 5, Professional Representation.

In the case of a joinder under Rule 21(1) CTMIR, where the oppositions are successful, the Office will fix both (or all) opposition fees (one for each opposition) but only one representation fee, in which case the costs to be paid by the applicant to the opponents would be EUR 1 000.

As regards the costs of the opposition procedure, one single decision on the apportionment and on the fixing of costs must be taken for the opposition procedure as a whole.

When a decision is annulled by the Boards of Appeal and remitted to the Opposition Division, the Opposition Division has to decide on the case again and will take a decision on and fix the costs in the usual way.

If this decision is appealed again (and not remitted for a second time) the Board will decide on and fix the costs in the usual way.

5.6.2 Procedure if the fixing of costs is contained in the main decision

Rule 94(3) CTMIR

Where the decision fixing the amount of costs is included in the decision on the apportionment of the costs, no bill or proof whatsoever is needed. The Office knows that the opposition fee was paid and, if there is a representative, EUR 300 must be awarded irrespective of any evidence. It is assumed that the costs of representation have been of at least EUR 300.

Therefore, no correspondence with the parties about the amount to be fixed is necessary. The fixing of the amount is automatic.

5.6.3 Procedure if a separate fixing of costs is needed

The following procedural requirements apply in the rare cases where a separate fixing of costs must be made (including when it was inadvertently omitted; in that case the party concerned must also comply with the applicable requirements):

- admissibility
- evidence.

5.6.3.1 Admissibility

Article 85(6) CTMR

The request for fixation of costs is only admissible once the decision in respect of which the fixing of costs is required has become final and until two months after that date.

5.6.3.2 Evidence

Rule 94(3) CTMIR

For awarding the opposition fee, no evidence is needed.

For awarding the representation costs at the standard rate, an assurance by the representative that the costs have been incurred is sufficient. A fortiori, if a bill is presented, it suffices that it shows at least the reimbursable amount; it does not matter whether it is addressed to the party to the proceedings, as submitting a bill equals an assurance.

For all other costs (which will apply in extremely rare cases), a bill and supporting evidence are needed, but it suffices that these make it plausible (rather than provide fully-fledged proof) that the costs have been incurred.

5.6.4 Review of fixing of costs

Article 85(6) CTMR Rule 94(4) CTMIR
--

If one of the parties disagrees with the amounts fixed, it can ask for a review of the decision. The request must state the reasons and be filed within one month after the date of notification of the fixation. The request is only deemed to be filed when the fee for review of EUR 100 has been paid.

There are no reimbursable costs in the review procedure (decision of 16/12/2004, R 0503/2001-4, BIOLACT/BIO).

6 Procedural Issues

6.1 Correction of mistakes

Article 43(2) CTMR Rule 53 CTMIR

6.1.1 Correction of mistakes in the notice of opposition

There are no special provisions in the Regulations on correction of mistakes in the notice of opposition. Applying Article 43(2) CTMR, which refers to the CTM application, by analogy, obvious mistakes in the notice of opposition may be corrected.

The Office defines 'obvious error' in relation to Article 43(2) CTMR and Rule 53 CTMIR as in No B.16 of the Joint Statements by the Council and the Commission entered in the minutes of the Council meeting at which the CTMR was adopted: '... the words 'obvious mistake' should be understood as meaning mistakes which obviously require correction, in the sense that nothing else would have been intended than what is offered as the correction'.

For example, if the opponent's details appear where the representative's should appear, this can be considered an obvious mistake.

6.1.2 Correction of mistakes and errors in publications

Rule 14 CTMIR

Where the publication of the application contains a mistake or error attributable to the Office, the Office will correct the mistake or error on its own initiative or at the request of the applicant.

The corrections effected under this rule have to be published. If the correction concerns mistakes that do not affect the opposition, it will be published when the CTM is registered. Where the correction leads to an extension of the list of goods or services or concerns the representation of the mark, a new opposition period is opened, but only in respect of the corrected parts.

If oppositions were filed after the 'first' publication of the CTM application, the opponents will have to be informed of the republication. The opponents that opposed the 'first' publication do not have to file a new opposition. The proceedings must be suspended until the opposition period following the 'second' publication has expired.

If a 'first publication opponent' wishes to withdraw its opposition as a consequence of the republication, the proceedings should be closed and the opposition fee should be refunded (see paragraph 5.4.1.2 above).

6.2 Time limits

Rule 71(1), Rule 79 and Rules 80(3), 82(3) and 96(1) CTMIR
--

Time limits are an essential tool for conducting orderly and reasonably swift proceedings. They are a matter of public policy, and rigorous compliance with them is necessary for ensuring clarity and legal certainty.

For general information on time limits and continuation of proceedings, see the Guidelines, Part A, General Rules, Section 1, Means of Communication, Time Limits.

6.2.1 Extension of time limits in opposition proceedings

6.2.1.1 Non-extendable and extendable time limits

Rule 71(1) CTMIR

A time limit cannot be extended if its length is set by the Regulation. Non-extendable time limits include:

Article 41(1) CTMR

- the three-month opposition period to file an opposition;

Article 41(3) CTMR

- the three-month time limit to pay the opposition fee;

Article 8(3)(b) CTMFR

- the one-month time limit to pay the surcharge where payment arrives late and no proof is made that it was initiated at least 10 days before expiry of the time limit for payment;

Rule 17(4) CTMIR

- the two-month time limit to remedy deficiencies according to Rule 17(4) CTMIR.

Rule 71(1) CTMIR

The length of extendable time limits is specified by the Office. For example, the time limit to submit observations in reply to the notice of opposition is an extendable time limit.

6.2.1.2 Request made in time

Note: Extensions of the cooling-off period have a special regime. For further details, see above under paragraph 3.2, Extension of the cooling-off period.

For **an extension to be granted** the request has to fulfil the following conditions:

- the time limit must be extendable;
- the extension has to be requested by the party concerned or jointly by both parties;
- the request has to be signed;
- the original time limit must not have expired already;
- the language regime must be respected, i.e. if the request is not in the language of the proceedings a translation must be submitted within one month of filing, otherwise the request will not be taken into account.

An extension will only be possible if the relevant request is filed and received before the expiry of the original term (order of 30/01/2014, C-324/13 P, Patricia Rocha, EU:C:2014:60). If a request for extension is received by the Office after the expiry of the time limit, it must be rejected.

As a general rule, the first request for an extension that is received in time will be considered appropriate and will be granted for a period of two months (or less if so requested). However, any subsequent request for an extension of the same time limit will be refused, unless the party requesting it duly explains and justifies the exceptional circumstances that prevented it from meeting the original time limit and the first extension and why a further extension is necessary. General or vague explanations will not justify a second extension. The request must always be accompanied by evidence and/or supporting documentation.

On the other hand, circumstances that are within the control of the party concerned are not 'exceptional circumstances'. For example, last-minute discussions with the other party are not 'exceptional circumstances'. They are within the control of the parties.

The request has to be filed by the party affected by the time limit. For example, if the applicant has to submit observations in reply to the notice of opposition, it can only be the applicant that asks for an extension.

For more information on extensions of time limits, consult the Guidelines, Part A, General Rules, Section 1, Means of Communication, Time Limits, paragraph 3.1.3.

6.2.1.3 Extension of a time limit by the Office on its own initiative

The Office can extend a time limit on its own initiative, if and when particular reasons make it necessary. For example, a request to extend a time limit without any justification is received by the Office 20 days before the end of the time limit to file observations but was not dealt with until after expiry of the time limit. Because the refusal of the request after expiry of the time limit will disproportionately harm the interests of the party who requested the extension, the Office extends the time limit by the number of days that were left when the party sent in its request, in this case 20 days. This practice is based on the rules of fair administration.

Where a request for extension of an extendable time limit has been filed and received before the expiry of this time limit (order of 30/01/2014, C-324/13 P, Patricia Rocha, EU:C:2014:60), the party concerned will be granted at least one day, even if the request for extension arrived on the last day of this time limit.

6.2.1.4 Signature

If one of the requests is not signed, it has to be checked if a second, signed, request was received at a later time but still within the time limit. This is because parties sometimes forget to sign, but realise their error after having sent the request, so they sign it and send it again.

A joint request has to be signed by both parties and has to be received within the time limit for which an extension is requested. A request signed by one of the representatives, assuring the Office that the other party agrees to the extension is not acceptable.

6.3 Suspension

Rules 20(7) and 21(2) CTMIR

The Office can suspend opposition proceedings either *ex officio*, or at the request of either one or both parties.

According to Rule 20(7) CTMIR, the Office ‘may’ suspend opposition proceedings. Therefore, the decision to suspend is always taken at the discretion of the Office.

6.3.1 Suspension requested by both parties

If both parties request suspension after expiry of the cooling-off period, they do not have to give any specific justification, and the suspension is always granted. In this case, and regardless of the period requested by the parties, the first suspension will be granted for a period of one year, with the parties being given the possibility of opting out. The process for opting out is the same as for the extension of the cooling-off period: if one party opts out, the suspension will end 14 days after the parties have been informed thereof. The proceedings will resume the day after and the party whose time limit was pending at the moment of suspension will be granted a time limit of two months. It is not possible to opt out during the last month of the suspended period and any requests to do so will be rejected.

A joint request for suspension because of ongoing negotiations will not be granted if it is received within the cooling-off period because the purpose of the cooling-off period is to set a time frame for negotiations before the adversarial stage begins.

In principle, the parties may jointly request extensions of the suspension for negotiations. Such requests will be granted automatically for further one-year periods. However, after three years of suspension the parties are expected to provide an explanation as to why the negotiations have still not come to an end. In order to avoid any possible abuse, the Office may apply its discretion and decide not to further suspend the proceedings.

Requests submitted by only one of the parties will in principle be rejected. It is common for parties to negotiate during opposition proceedings. However, it may be the case that one party wishes to negotiate only provided that such negotiations do not delay the proceedings. This is why negotiations do not give either of the parties the right to ignore a pending time limit, to obtain an extension thereof or to obtain a suspension of the proceedings. Such requests are therefore rejected.

6.3.2 Suspensions by the Office *ex officio* or at the request of one of the parties

The Office may suspend the opposition proceedings *ex officio* or at the request of one party under a variety of circumstances.

The CTMIR contemplates two specific cases where proceedings may be suspended:

- The opposition is based on an application for registration of a trade mark (including conversion).

- The opposition is based on an application for registration for a geographical indication or designation of origin.

In addition, according to the CTMIR, the proceedings may be suspended where appropriate under the circumstances, for example in the following situations:

- The earlier right is at risk (under opposition or cancellation).
- There are third-party observations that raise serious doubts as to the registrability of the CTM application (see page 51).
- There are errors in the publication of the contested application that require the mark to be republished.
- A transfer is pending on earlier CTMs/CTM applications or contested CTM applications.
- The representative withdraws.

It should be noted that there is no obligation in any of the abovementioned cases to suspend the proceedings. The decision is at the Office's discretion.

6.3.2.1 Explanation of the basic principle, timing of suspension

Rule 20(7) CTMIR

In principle, oppositions based on (i) applications or (ii) earlier rights that are at risk are not to be suspended *ex officio* at the very beginning of the proceedings. The assumption is that in most cases applications mature into registrations, and oppositions or cancellation actions against earlier rights might be solved during the proceedings.

In these cases the opposition proceeds until a decision is ready to be taken. Consideration must then be given as to whether the earlier right in question could make a difference, in a prima facie opinion, to the outcome of the opposition. If the opposition is deemed to be successful or rejected anyway, regardless of the fate of the earlier right at risk, the proceedings should not be suspended. If, in contrast, the earlier right at risk must necessarily be taken into account in the decision on the opposition, the proceedings will be suspended and, in the case of a national application or an earlier national mark at risk, the opponent must be requested to provide information on the status of the application or registration. For earlier CTMs, the Office has this information at its disposal.

However, the Office may suspend the proceedings earlier if this is **requested by one of the parties** and the earlier right is an application or is at risk. If the earlier right is a national one the parties must provide evidence that it is facing problems. In this case the outcome of the proceedings against the earlier mark must have some impact on the opposition. Therefore, the probable outcome of the opposition will be considered in order to decide on suspension — in particular, whether the final decision on the opposition cannot be issued without taking into account the earlier application or earlier registration. This will be the case if the circumstances of the case do not allow the Office to say that the opposition will be rejected (e.g. because there is no likelihood of confusion) or upheld (because there are other earlier rights that are sufficient to reject the contested mark for all the contested goods and services).

When an opposition is based on an application for registration, it may be appropriate to suspend the opposition proceedings under Rule 20(7) CTMIR to await registration of the opponent's earlier mark. However, if an opposition is to be rejected, either for

formal or for substantive reasons, a suspension would be meaningless and would simply prolong the proceedings unnecessarily.

When there are no other earlier rights to take into account (because there are no other earlier rights or they were not substantiated) or when the application or registration must nevertheless be taken into account (because the other earlier rights are not 'winners'), an assessment must be made of whether the opposition will be successful on the basis of the application, in order to decide on the suspension. Proceedings will only be suspended if it is found that the earlier application, if registered, will lead to the total or partial rejection of the contested CTM application.

6.3.2.2 Earlier CTM applications or registrations

The opposition is based on an application but is not suspended because there is another earlier right (a registered trade mark) on the basis of which the contested application may be rejected. If the opponent fails to substantiate this other earlier right, the earlier application becomes crucial for the decision. If, according to the records, the only earlier application or registration is facing problems, the opposition should be suspended.

6.3.2.3 Earlier national/international marks (applications or registrations/rights)

The issue of suspension will have to be raised by the parties (normally the applicant). In this case the party has to submit evidence that the earlier mark (application or registration/right) is facing problems. This evidence must be official, it must clearly identify the proceedings leading to the suspension and it must indicate the relief sought. In particular, the evidence must be clear as to the possible consequences for the earlier right on which the opposition is based. If necessary, the party may be requested to submit a translation of the evidence.

Upon such a request the Office will consider whether under the circumstances of the case it is advisable to suspend the proceedings.

If no one raises the question, then the general principle applies and the Office only has to decide on the suspension if the proceedings reach the end of the adversarial part and there is no information that the application has matured to registration or that national proceedings against the earlier mark have come to an end. In this case the opponent should be required to inform the Office on the status of its earlier application or registration.

6.3.2.4 Examples

Here are some examples where, according to the general practice indicated above, the situation apparently does not require suspension of the proceedings but the suspension can nevertheless be decided if the Office finds it appropriate.

- The opposition is based on a French mark and on a CTM application, neither of which faces problems. Both cover the same sign and the same goods, which are confusingly similar to the contested trade mark. Therefore, the opposition may be dealt with on the basis of the French mark only. If likelihood of confusion can occur only in Member States other than France, the decision will be more solid if

based on the CTM application and therefore it is appropriate to suspend the proceedings to await the outcome of the CTM application.

- The earlier application does not make any difference to the outcome, but the applicant requests a suspension. If the earlier right is a CTM application and the Office concludes that it is facing problems or, in the case of a national application, if the applicant submits evidence that the opponent's application is facing problems, the proceedings may be suspended.

The following examples fall into the category of earlier national marks facing problems:

- the applicant (or a third party) has filed an action or a counterclaim seeking the invalidation or revocation of the earlier registration;
- the applicant (or a third party) has filed an action or a counterclaim seeking the transfer of the earlier right to its own name.

6.3.3 Multiple oppositions

Rule 21(2) CTMIR

Except for under exceptional circumstances, such as where one opposition clearly leads to the rejection of the contested mark including all goods and services, the Office will not suspend the other proceedings.

6.3.3.1 After rejection of the CTM application

When the CTM application is subsequently rejected because of an 'active' opposition, the suspended oppositions are deemed to have been disposed of after the decision becomes final. If the decision has become final, the parties to the other proceedings must be informed, the oppositions that were suspended at an early stage (before the cooling-off period) will be closed, and 50 % of the opposition fee will be refunded to each opponent, in accordance with Rule 21(4) CTMIR.

If an appeal has been filed against the decision, the oppositions remain suspended. If BoA reverses the decision, the other proceedings will be resumed immediately, without having to wait for that decision to become final.

6.3.4 Procedural aspects

Letters suspending the proceedings should always indicate the date the suspension takes effect — generally the date when a valid request was submitted.

6.3.4.1 Monitoring suspended files

In cases where the proceedings are suspended for an indefinite period, the Office will monitor the opposition every six months.

In cases where the earlier right is an application for a national registration or a national/international registration that faces problems, the resumption of proceedings

will always depend on the reaction of the parties, which are expected to inform the Office about any changes in the status of the application or registration and submit evidence to this effect. Nevertheless, the Office issues reminders every six months in which the parties may also be requested to submit the evidence.

6.3.4.2 Resuming the proceedings

In all cases the parties will be informed of the resumption of the proceedings and of any pending time limit if applicable. Any time limit that was pending at the moment of the suspension will be set again with a full two-month time limit with the exception of the cooling-off period, which can never exceed 24 months according to Rule 18(1) CTMIR.

Proceedings must be resumed as soon as a final decision has been rendered in the course of the national proceedings or an earlier application has been registered or refused. If the decision taken in the national proceedings invalidates, revokes, or results in some other way in the extinguishment of the right, or transfers the opponent's earlier right, the opposition is deemed unfounded insofar as it is based on that earlier right. If all the earlier rights on which an opposition is based cease to exist, the opponent will be granted the opportunity to withdraw its opposition. If it does not do so, the Office will take a decision rejecting the opposition.

6.3.4.3 Calculation of time limits

If the suspension is decided for a definite period of time, the letters must also indicate the date when the proceedings are to be resumed, and what happens after that. When the suspension is requested by both parties because there are ongoing negotiations, the period will always be one year, regardless of the period requested by the parties.

If on 30/01/2015 a request for a two-month suspension signed by both parties and submitted on 15/01/2015 (five days before the expiry of the time limit of the opponent for completing the opposition — 20/01/2015) is dealt with, the result will be that:

- the Office has suspended the opposition proceedings at the request of both parties;
- this suspension takes effect as from 15/01/2015 (the date when the suspension request was received at the Office) and will expire on 15/01/2016;
- the proceedings will be resumed on 16/01/2016 (one year, irrespective of the period requested by the parties), with no further notification from the Office;
- the time limit for the opponent is now 15/03/2016 (two full months for the opponent to complete the file);
- the time limit for the applicant is now 15/05/2016 (two full months after the opponent's time limit).

6.4 Multiple oppositions

Rule 21 CTMIR

Multiple oppositions are when different oppositions are filed against the same CTM application.

In the case of multiple oppositions, some extra factors have to be taken into account.

First of all, unless there is a major delay during the admissibility stage concerning one of the oppositions, the practice is to notify the applicant of the admissibility of all the oppositions at the same time. Secondly, multiple oppositions may lead to suspension of some of them for reasons of economy of proceedings. Thirdly, a restriction made by the applicant in the course of one of the proceedings may have an impact on the other oppositions. Furthermore, it may be practical to take the decisions in a certain order.

Finally, under certain circumstances, multiple oppositions may be joined and dealt with in one set of proceedings.

6.4.1 Multiple oppositions and restrictions

When there are multiple oppositions and the applicant restricts the goods and services in one of the opposition proceedings, all the other opponents will have to be informed by sending the appropriate letter insofar as the restriction concerns contested goods or services of the other oppositions.

However, if there is no relation between the goods or services in the restriction and the contested goods and services, the opponent should not be informed.

For example, there are four oppositions against the same CTM application, applied for in respect of goods in Classes 3, 14, 18 and 25. The oppositions are directed against the following classes:

Opposition	Extent
No 1	Class 3
No 2	Class 25
No 3	Classes 18 and 25
No 4	Classes 14 and 25

The applicant sends a restriction in opposition 2, deleting *clothing* and *headgear*. Apart from the relevant letters in opposition 2, the relevant letters should also be sent in oppositions 3 and 4. As the restriction does not affect the contested goods of opposition 1, no action is necessary in this opposition.

6.4.2 Multiple oppositions and decisions

Once an opposition reaches the decision stage, it is important to take account of the possible multiple oppositions that are pending against the same CTM application. Before a ruling can be given on the opposition, the stage of proceedings of the multiple oppositions must be analysed and, depending on the situation, a decision may be

taken or the opposition must be suspended. The general principle to be applied is that contested goods and services should not be rejected more than once at different points in time. The three situations that may occur are described in the following.

1. All oppositions against the same CTM application are ready for decision at the same time

The order in which the decisions are taken is at the discretion of the examiner. However, the following has to be taken into account.

If all oppositions will fail, the decisions can be taken in any order, as the rejection of the opposition does not affect the CTM application. Even if one of the decisions were to be appealed before the others are taken, it would seem preferable not to suspend as the procedure before the Board of Appeal can take some time.

If several oppositions will be successful against overlapping goods and services, first the decision eliminating most goods and services of the CTM application (the widest extent of the opposition) should be taken and the remaining oppositions suspended. Once the first decision is final, the opponents in the remaining oppositions must be consulted on whether they wish to maintain or withdraw their oppositions.

Assuming that the oppositions are maintained, the next 'widest' opposition is decided and the same process continues until all of the oppositions are dealt with.

When two oppositions are of the same extent, the general principles apply when taking the decisions.

In the example mentioned above under paragraph 6.4.1, the first decision should either be taken in opposition 3 or in opposition 4. Opposition 1 has no overlapping goods and services and can therefore be taken independently.

Suppose the first decision is taken in opposition 4, and the CTM application is rejected for Classes 14 and 25. In this case, oppositions 2 and 3 need to be suspended.

If the appeal period has expired and no appeal is filed, opposition 2 is disposed of, as it no longer has an object. The parties should be informed and the opposition must be closed. The case is considered to be a case that has not proceeded to judgment within the meaning of Article 85(4) CTMR. Consequently, the costs are at the discretion of the Office. If the parties inform the Office that they agree on the costs, a decision on costs will not be taken. Generally, the decision will be that each party bears its own costs.

2. Only one opposition is ready for decision and the other oppositions are still in the adversarial phase of the proceedings

If the opposition is to be rejected, a decision can be taken without further impact on the pending multiple oppositions because the rejection does not have any effect on the CTM application.

If the opposition is successful and the decision rejects the contested CTM application in its entirety, the pending multiple oppositions must be suspended until the decision is final. If the appeal period has expired and no appeal is filed, the multiple oppositions are disposed of, as they no longer have an object. The parties should be informed and the opposition must be closed. The case is considered to be a case that has not proceeded to judgment within the meaning of Article 85(4) CTMR. Consequently, the costs are at the discretion of the Office. If the parties inform the Office that they agree

on the costs, a decision on costs will not be taken. Generally, the decision will be that each party bears its own costs.

The same applies if the decision on the opposition rejects **part** of the goods and services of the contested CTM application but **all** of the goods and services against which the multiple oppositions are directed.

However, multiple oppositions must be suspended if the decision on the opposition rejects **part** of the goods and services of the contested CTM application but only **part** of the goods and services against which the multiple oppositions are directed. The suspension will last until the decision has become final. If this is the case, the opponents of the multiple oppositions will be invited to inform the Office whether they wish to maintain or withdraw the opposition. In the case of a withdrawal of the opposition, the proceedings are closed and both parties are informed. If the proceedings are closed after the expiry of the cooling-off period, the Office will decide on the costs in accordance with Article 85(2) CTMR that each party bears its own costs. If the parties inform the Office before the closure of proceedings that they agree on the costs, a decision on costs will not be taken.

3. Two or more oppositions are ready for decision and others are still in the adversarial phase of the proceedings

It may happen that some of the oppositions against a CTM application are ready for a ruling and some are still at different stages of the adversarial phase. In this situation the principles described under 1 and 2 apply in combination. It depends on the outcome of the decisions and on the scope of the pending cases whether a decision may be taken in some oppositions and whether the multiple oppositions must be suspended.

6.4.3 Joinder of proceedings

Rule 21(1) CTMIR

Rule 21(1) CTMIR allows the Office to deal with multiple oppositions in one set of proceedings. If it is decided to join the oppositions, the parties must be notified.

Oppositions may be joined upon the request of one of the parties if they are directed against the same CTM application. It is more likely that the Office would join them if, in addition, they were filed by the same opponent or if there is an economic link between the opponents, e.g. a parent and subsidiary company. The oppositions must be at the same procedural stage.

When it is decided to join the oppositions it should be verified whether the opponents have the same representative. If not, they must be asked to appoint one single representative. In addition, the earlier rights must be identical or very similar. If the representatives do not reply or do not want to appoint a single representative, the joinder must be undone and the oppositions dealt with separately.

If at any stage these conditions are no longer fulfilled, for example the one and only earlier right of one of the joined oppositions is transferred to a third party, the joinder may be undone.

Unless the joinder is undone before the decision is taken, only one decision is taken.

6.5 Change of parties (transfer, change of name, change of representative, interruption of proceedings)

6.5.1 Transfer and opposition proceedings

6.5.1.1 Introduction and basic principle

Article 17 CTMR

A transfer or assignment of an earlier right is a change of ownership of this right. For further information see the Guidelines, Part E, Register Operations, Section 3, CTMs as Objects of Property, Chapter 1, Transfer.

The basic principle is that the new owner substitutes the old owner in the proceedings. The Office's practice for dealing with transfers is described in paragraphs 6.5.1.2 (the earlier registration is a CTM registration), 6.5.1.3 (the earlier registration is a national registration), 6.5.1.4 (the earlier registrations are a combination of CTM registrations and national registrations) and 6.5.1.5 (transfer of a contested CTM application during opposition proceedings).

A transfer can be made in several ways, including a simple sale of an earlier mark from A to B, a company C that gets bought (trade marks included) by company D, a merger of companies E and F into company G (universal succession), or legal succession (after the owner has died, the heirs become the new owners). This is not an exhaustive list.

When a transfer is made during opposition proceedings, several situations can arise. Whereas for earlier CTM registrations or applications on which the opposition is based the new owner can only become party to the proceedings (or file observations) once the request for registration of the transfer has reached the Office, for earlier national registrations or applications it suffices that the new owner files evidence of the transfer.

6.5.1.2 Transfer of earlier CTM

Article 17(6), (7) CTMR

Concerning earlier CTM(A)s, according to Article 17(6) CTMR, as long as a transfer has not been entered in the Register, the successor in title may not invoke the rights arising from the registration of the CTM(A). However, in the period between the date of reception of the request for registration of the transfer and the date of registration of the transfer, the new owner may already make statements to the Office with a view to observing time limits.

Opposition based on one CTM only

When an opposition is based on one earlier CTM only and this CTM is/has been transferred during the opposition proceedings the new owner becomes the new opponent. The new owner will substitute the old owner.

To this end, either the old or the new owner will have to inform the Office that the CTM on which the opposition is based has been transferred and it must submit a request for registration of the transfer. As mentioned above, as soon as the request is received by the Office, the new owner may already make statements. However, it only becomes party to the proceedings once the transfer is registered.

In practice, once the Office is informed that a request for registration is received, the proceedings can continue with the new owner. Nevertheless, the transfer has to be registered before a decision on the opposition is taken. If the opposition is ready for decision but the transfer has not been registered, the opposition must be suspended.

If the new owner informs the Office that it does not want to continue the proceedings, the opposition is considered withdrawn.

Partial transfer of the only CTM on which the opposition is based

In cases of a partial transfer one part of the earlier CTM remains with the original owner and another part is transferred to a new owner. The same principles apply to partial transfers as to the transfer of only one of a number of CTM registrations on which the opposition is based, as described in the paragraph immediately below.

Opposition based on more than one earlier CTM

When an opposition is based on more than one earlier CTM and all these marks are/have been transferred to the same new owner during the opposition proceedings, the situation is the same as for an opposition based on a single CTM, as described above.

The situation is, however, different when only one of the earlier CTMs is/has been transferred. In this case the new owner may also become an opponent, with the result that there are two opponents. The new opponents will be treated as 'joint opponents', meaning that the Office will continue dealing with the case in exactly the same way as before, i.e. as one opposition, albeit with more than one opponent. Moreover, the Office will consider the original representative as the 'common' representative for all the opponents and will not invite the new opponents to appoint a new one. However, the new opponents always have the option of appointing a representative of their choice.

Common representation does not mean that opponents may not act independently, to the extent that their earlier rights remain independent: if, for instance, one of the opponents enters into a friendly settlement with the applicant, the opposition will be treated as partially withdrawn in respect of the earlier rights owned by this opponent.

If one of the joint opponents wants to withdraw, this will be accepted independently of whether the other wants to continue. Should the proceedings be continued, they will only be based on the rights of the opponent that did not withdraw. No separate decision on costs will be taken.

6.5.1.3 Transfer of earlier national registration

Opposition based on one national registration only

When an opposition is based on one earlier national registration only and this registration is/has been transferred during the opposition proceedings, the new owner also becomes the new opponent. The new owner will substitute the old owner.

To this end, either the old or the new owner will have to inform the Office that the earlier national registration on which the opposition is based has been transferred and must file evidence thereof, i.e. the deed of transfer or any other evidence showing the agreement of the parties to the transfer/change of ownership.

The Office does not require the new owner to confirm that it wishes to continue the proceedings. As long as the evidence of the transfer is in order, the new owner is accepted as the new opponent. If it informs the Office of the transfer, but does not submit (sufficient) evidence thereof, the opposition proceedings have to be suspended while the new owner is given a time limit within which to provide evidence of the transfer.

As there are different national practices, it is not always obligatory to submit a copy of the request to register the transfer with the national office. Nevertheless, in those Member States where there is a requirement for a transfer to have effect against third parties, the transfer must have been registered before a decision on the opposition is taken. If the opposition is ready for decision but the transfer has not been registered, the opposition must be suspended and the opponent is to be required to provide evidence of registration of the transfer.

If the new owner does not provide the required evidence, the proceedings must be continued with the old owner. If the old owner maintains that it is not the owner any more, the opposition has become unfounded, as the opponent is no longer the owner of the earlier right. The old owner must be informed that the opposition will be rejected as such unless it withdraws the opposition.

If the new owner provides the required evidence and informs the Office that it does not want to continue the proceedings, the opposition is considered withdrawn.

Partial transfer of the only national registration on which the opposition is based

In cases of a partial transfer, one part of the earlier national registration remains with the original owner and another part with a new owner. The same principles apply to partial transfers as to transfers of only one of a number of national registrations on which the opposition is based, as described in the paragraph immediately below.

Opposition based on more than one earlier national registration

When an opposition is based on more than one earlier national registration and these are/have been transferred to the same new owner during the opposition proceedings, the situation is the same as for the transfer of a single mark upon which an opposition is based, as described above.

The situation is, however, different when only one of the earlier national rights is/has been transferred. In this case the new owner may also become an opponent, with the result that there are two opponents. The new opponents will be treated as 'joint opponents', meaning that the Office will continue dealing with the case in exactly the same way as before, i.e. as **one** opposition, albeit with more than one opponent. Moreover, the Office will consider the original representative as the 'common' representative for all the opponents and will not invite the new opponents to appoint a new one. However, the new opponents always have the option of appointing a representative of their choice.

If one of the joint opponents wants to withdraw, this is to be accepted independently of whether the other wants to continue. Of course, if the proceedings are continued it will be based only on the rights of the opponent that did not withdraw. No separate decision on costs will be taken.

6.5.1.4 Opposition based on a combination of CTM registrations and national registrations

When an opposition is based on one or more CTM registrations **and** one or more national registrations at the same time and one of these marks are/have been transferred to the same new owner during the opposition proceedings, the principles set out above apply *mutatis mutandis*.

In all of these situations, once the Office becomes aware of the transfer of ownership, it will update the official database to include the new opponent/both opponents, and it will inform the parties for information purposes only. However, the mere fact that the earlier registrations have been transferred will never justify the granting of a new time limit for submitting observations or any other documents when the original time limit has expired.

6.5.1.5 Transfer of the contested CTM application

When during opposition proceedings the contested CTM application is/has been transferred, the opposition follows the application, i.e. the opponent is informed of the transfer and the proceedings continue between the new owner of the CTM application and the opponent.

6.5.1.6 Partial transfer of a contested CTM application

Rule 32(4) CTMIR

When there has been a partial transfer of a (contested) CTM application, the Office must create a separate file for the new registration (application) with a new registration (application) number.

In this case, when the transfer is recorded in the Register and a new CTM application is created, the opposition examiner also has to create a new opposition file against the new CTM application, since it is not possible to deal with one opposition against two separate CTM applications.

However, this is only the case when some of the originally contested goods and services are maintained in the 'old' CTM application and some in the newly created CTM application. For example: Opponent X opposes all the goods of CTM application Y, applied for in Class 12 for *apparatus for locomotion by land and air*, and for *clothing and footwear* in Class 25. CTM application Y is partially transferred, and split into old CTM application Y for *apparatus for locomotion by land and clothing*, and new CTM application Y for *apparatus for locomotion by air, and footwear*.

Articles 17 and 23 CTMR

Since there was only one opposition fee to be paid when the opponent filed its opposition, a second fee for the new opposition created after the split of the CTM application is not required because, at the time of filing, the opposition was only directed against one CTM application.

Regarding the apportionment of costs, the opposition examiner will take into account the fact that only one opposition fee was paid.

Moreover, depending on the circumstances of the case, it could be possible to join the proceedings (e.g. when the representative of the 'old' and 'new' applications is the same).

6.5.2 Parties are the same after transfer

In the event that, as a result of a transfer, the opponent and applicant become the same person or entity, the opposition becomes devoid of any purpose and will accordingly be closed *ex officio* by the Office.

6.5.3 Change of names

As mentioned above, a change of name does not imply a change of ownership.

6.5.4 Change of representatives

Article 92 CTMR

When there is a change of representative during opposition proceedings, the other party will have to be informed by sending it a copy of the letter and of the authorisation (if submitted).

For detailed information please refer to the Guidelines, Part A, General Rules, Section 5, Professional Representation.

6.5.5 Interruption of the proceedings due to death or legal incapacity of the applicant or its representative

Rule 73 CTMIR

Rule 73 CTMIR deals with interruption of proceedings. Paragraph 1 distinguishes three situations:

Opposition proceedings before the Office will be interrupted:

1. when the CTM *applicant* has died or is under legal guardianship;
2. when the CTM *applicant* is subject to bankruptcy or any similar proceedings;
3. when *the representative of an applicant* has died or is otherwise prevented from representing the applicant. For further information see the Guidelines, Part A, General Rules, Section 5, Professional Representation.

Rule 73 CTMIR only refers to the applicant and its representative and does not mention anything about other parties, such as opponents. In the absence of relevant provisions, the Office will apply this provision only to cases where the applicant (or its representative) is not able to continue the proceedings. Therefore, if, for example, the opponent is declared bankrupt, the proceedings will not be interrupted (even where the opponent is the applicant/proprietor of an earlier CTM application/CTM). The uncertainty of the legal status of an opponent or its representative will not be to the detriment of the applicant. In such a case, when the notification is returned to the Office as undeliverable, the normal rules for public notification apply.

6.5.5.1 Death or legal incapacity of the applicant

In the event of the death of the applicant or of the person authorised by national law to act on their behalf, because of the legal incapacity of the applicant, the proceedings are only interrupted when this is requested by the representative of the applicant/authorised person or when the representative resigns.

6.5.5.2 Applicant prevented from continuing the proceedings before the Office owing to legal reasons (e.g. bankruptcy)

Rule 73(1)(b) and Rule 73(4) CTMIR

Rule 73(1)(b) CTMIR applies from the point in time from which the party to the proceedings is no longer entitled to dispose of the procedure, i.e. to dispose of its assets, until the point in time a liquidator or trustee is appointed who will then continue to represent the party under the law.

When the applicant is represented by a professional representative who does not resign, there is no need to interrupt the proceedings. The Office considers the applicant's representative to be entitled to represent the applicant until the Office is informed otherwise by the representative itself, by the designated trustee or the court dealing with the legal action in question.

If the representative informs the Office that it resigns, it depends whether the representative further indicates who acts as the trustee or liquidator in the bankruptcy.

- If the representative does so, the Office will continue to correspond with the trustee or liquidator. If there were time limits affecting the applicant that had not yet expired when it went bankrupt, the Office will re-start these time limits. Therefore, in this case, the proceedings are interrupted and immediately resumed. For example, if the applicant still had ten days to file observations when it went bankrupt, the new letter of the Office to the trustee will give a fresh time limit of two months to file those observations.
- If there is no information as to a liquidator or trustee, the Office has no choice but to declare an interruption of the proceedings. A communication to that effect will be sent to the bankrupt applicant directly and to the opponent. Although it is not up to the Office to investigate who the liquidator is, the Office will keep on trying to communicate with the bankrupt applicant with the aim of resuming the proceedings. This is because, although the bankrupt applicant is not allowed to undertake binding legal acts, generally it still receives correspondence, or, if not, the correspondence is delivered automatically to the trustee as long as there is one. The Office might also consider information on the identity of the trustee provided by the opponent.

When the notification is returned to the Office as undeliverable, the normal rules for public notification apply.

If evidence about the appointment of the liquidator or trustee is submitted, this need not be translated into the language of the proceedings.

Once the Office is informed of who the liquidator or trustee is, the proceedings are resumed from a date to be fixed by the Office. The other party must be informed.

Time limits that had not yet expired when the proceedings were interrupted start running again when the proceedings are resumed. For example, when the proceedings were interrupted ten days before the applicant had to submit observations, a new time limit of two months starts again, not the ten days it had left at the moment of the interruption. For clarification, the letter sent by the Office informing the parties about the resumption will fix a new time limit.

6.5.5.3 Death or prevention for legal reasons of the representative of the applicant before the Office to act.

Article 92(2) CTMR Rule 73(1)(c) CTMIR

In the case referred to in Rule 73(1)(c) CTMIR, the proceedings must be interrupted and will be resumed when the Office is informed of the appointment of a new representative of the CTM applicant.

This interruption will last a maximum of three months and, if no representative is appointed before the end of this period, the proceedings will be resumed by the Office. When resuming the proceedings, the Office will proceed as follows:

1. If the appointment of a representative is compulsory under Article 92(2) CTMR because the applicant has neither its domicile nor its seat in the EU, the Office will contact the applicant and inform it that the CTM application will be refused if it does not appoint a representative within a specified time limit.
2. If appointment of a representative is **not** compulsory under Article 92(2) CTMR, the Office will resume the proceedings and will send all the communications to the applicant directly.

In both cases resuming the proceedings will mean that any time limits pending for the applicant when the proceedings were interrupted start running again when the proceedings are resumed.

***GUIDELINES FOR EXAMINATION IN THE
OFFICE FOR HARMONIZATION IN THE
INTERNAL MARKET (TRADE MARKS AND
DESIGNS) ON COMMUNITY TRADE MARKS***

PART C

OPPOSITION

SECTION 2

***DOUBLE IDENTITY AND LIKELIHOOD OF
CONFUSION***

CHAPTER 1

GENERAL PRINCIPLES

Table of Contents

1	Introduction.....	3
2	Article 8(1) CTMR.....	4
2.1	Article 8(1)(a) CTMR – double identity	4
2.2	Article 8(1)(b) CTMR – likelihood of confusion	4
2.3	Interrelation of Articles 8(1)(a) and 8(1)(b) CTMR.....	5
3	The Notion of Likelihood of Confusion.....	5
3.1	Introduction	5
3.2	Likelihood of confusion and likelihood of association.....	6
3.3	Likelihood of confusion and enhanced distinctiveness	7
3.4	Likelihood of confusion: questions of fact and questions of law	8
3.4.1	Fact and law – similarity of goods/services and of signs	8
3.4.2	Fact and law – evidence	9
4	Evaluation of the Factors Taken into Account for Establishing Likelihood of Confusion.....	9
4.1	The relevant point in time	9
4.2	List of factors for assessing likelihood of confusion.....	10
	Annex I	11

1 Introduction

This chapter provides an introduction to and overview of the concepts of (i) double identity and (ii) likelihood of confusion that are applied in situations of conflict between trade marks in opposition proceedings under Article 8(1) of Council Regulation (EC) No 207/2009 of 26 February 2009 on the Community trade mark (the 'CTMR').

The paragraphs below set out the nature of these concepts and their legal underpinning as determined by the relevant laws and as interpreted by the Court of Justice of the European Union (the 'Court')¹.

The legal concepts of double identity and likelihood of confusion are used to protect trade marks and, at the same time, to define their scope of protection. It is thus important to bear in mind what aspects or functions of trade marks merit protection. Trade marks have various functions. The most fundamental one is to act as 'indicators of origin' of the commercial provenance of goods/services. This is their 'essential function'. In the 'Canon' case the Court held that:

... according to the settled case-law of the Court, the essential function of the trade mark is to guarantee the identity of the origin of the marked product to the consumer or end user by enabling him, without any possibility of confusion, to distinguish the product or service from others that have another origin (emphasis added).

(Judgment of 29/09/1998, C-39/97, Canon, EU:C:1998:442, § 28).

The essential function of trade marks as indicating origin has been emphasised repeatedly and has become a precept of EU trade mark law (judgments of 18/06/2002, C-299/99, Remington, EU:C:2002:377, § 30; 06/10/2005, C-120/04, Thomson Life, EU:C:2005:594, § 23).

Whilst indicating origin is the essential function of trade marks, it is not the only one. Indeed, the term, 'essential function' implies other functions. The Court alluded to the other functions of trade marks several times (e.g. judgments of 16/11/2004, C-245/02, Budweiser, EU:C:2004:717, § 59; 25/01/2007, C-48/05, Opel, EU:C:2007:55, § 21) but addressed them directly in the 'L'Oréal' judgment, where it stated that the functions of trade marks include:

... not only the essential function of the trade mark, which is to guarantee to consumers the origin of the goods or services, but also its other functions, in particular that of guaranteeing the quality of the goods or services in question and those of communication, investment or advertising (emphasis added).

(Judgments of 18/06/2009, C-487/07, L'Oréal, EU:C:2009:378, § 58-59; 23/03/2010, C-236/08 – C-238/08, Google-Louis Vuitton, EU:C:2010:159, § 75-79).

In examining the concepts of double identity and likelihood of confusion, this chapter touches upon several themes that are explained comprehensively in the chapters of

¹The Court was in fact often interpreting Articles 4 and 5 of Directive 2008/95/EC of the European Parliament and of the Council of 22 October 2008 (the 'Directive') that for the purposes of interpretation are broadly comparable to Articles 8 and 9 CTMR.

the Guidelines that follow. The Annex contains a summary of the key cases dealing with the core principles and concepts of likelihood of confusion.

2 Article 8(1) CTMR

Article 8 CTMR enables the proprietor of an *earlier right* to oppose the registration of later CTM applications in a range of situations. The present chapter will concentrate on the interpretation of double identity and likelihood of confusion within the meaning of Article 8(1) CTMR.

An opposition pursuant to Article 8(1) CTMR can be based on earlier trade mark registrations or applications (Article 8(2)(a) and (b) CTMR) and earlier well-known marks (Article 8(2)(c) CTMR)².

2.1 Article 8(1)(a) CTMR – double identity

Article 8(1)(a) CTMR provides for oppositions based on identity. It provides that, upon opposition by the proprietor of an earlier trade mark within the meaning of Article 8(2) CTMR, a CTM application will not be registered:

if it is identical with the earlier trade mark and the goods or services for which registration is applied for are identical with the goods or services for which the earlier trade mark is protected.

The wording of Article 8(1)(a) CTMR clearly requires identity between both the signs concerned and the goods/services in question. This situation is referred to as ‘double identity’. Whether there is double identity is a legal finding to be established from a direct comparison of the two conflicting signs and the goods/services in question³. Where double identity is established, the opponent is not required to demonstrate likelihood of confusion in order to prevail; the protection conferred by Article 8(1)(a) CTMR is absolute. Consequently, where there is double identity, there is no need to carry out an evaluation of likelihood of confusion, and the opposition will automatically be upheld.

2.2 Article 8(1)(b) CTMR – likelihood of confusion

Article 8(1)(b) CTMR states that, upon opposition, a CTM application shall not be registered:

...if because of its identity with or similarity to the earlier trade mark and the identity or similarity of the goods or services covered by the trade marks there exists a likelihood of confusion on the part of the public in the territory in which the earlier trade mark is protected; the likelihood of confusion

² Further guidance on earlier well-known trade marks is found in the Guidelines, Part C, Opposition, Section 5, Trade Marks with Reputation (Article 8(5) CTMR).

³ Comprehensive guidance on the criteria to find identity between goods and services and between signs can be found in the respective paragraphs of the Guidelines, Part C, Opposition, Section 2, Double Identity and Likelihood of Confusion, Chapter 2, Comparison of Goods and Services and Chapter 4, Comparison of Signs.

includes the likelihood of association with the earlier trade mark (emphasis added).

Hence, in contrast to situations of double identity as seen above, in cases of mere similarity between the signs and the goods/services, or identity of only one of these two factors, an earlier trade mark may successfully oppose a CTM application under Article 8(1)(b) *only if* there is a likelihood of confusion.

2.3 Interrelation of Articles 8(1)(a) and 8(1)(b) CTMR

Although the specific conditions under Articles 8(1)(a) and 8(1)(b) CTMR differ, they are related. Consequently, in oppositions dealing with Article 8(1) CTMR, if Article 8(1)(a) is the only ground claimed but identity between the signs and/or the goods/services cannot be established, the Office will still examine the case under Article 8(1)(b) CTMR that requires at least similarity between signs and goods/services and likelihood of confusion. Similarity covers situations where both marks and goods/services are similar and also situations where the marks are identical and the goods/services are similar or vice versa.

Likewise, an opposition based only on Article 8(1)(b) CTMR that meets the requirements of Article 8(1)(a) CTMR will be dealt with under the latter provision without any examination under Article 8(1)(b) CTMR.

3 The Notion of Likelihood of Confusion

3.1 Introduction

The assessment of likelihood of confusion is a calculus applied in situations of conflict between trade marks in opposition proceedings under the CTMR as well as in infringement proceedings in the courts of the EU. However, neither the CTMR nor the Directive contains a definition of likelihood of confusion or a statement as to precisely what ‘confusion’ refers to. Unsurprisingly then, the precise meaning of the term ‘likelihood of confusion’ has been the subject of much debate and litigation.

As shown below, it has been settled case-law for some time now that fundamentally the concept of likelihood of confusion refers to situations where:

- (1) the public directly confuses the conflicting trade marks;
- (2) the public makes a connection between the conflicting trade marks and assumes that the goods/services in question are from the same or economically linked undertakings (likelihood of association).

These two situations are further discussed below (paragraph 3.2). The mere fact that the perception of a later trade mark brings to mind an earlier trade mark does not constitute likelihood of confusion.

The Court has also established the principle that ‘marks with a highly distinctive character, enjoy broader protection than marks with a less distinctive character’ (see paragraph 3.3 below).

Finally, the concept of likelihood of confusion as developed by the Court must be regarded as a legal concept rather than a purely realistic reflection of consumer cognitive behaviour and purchasing habits (see paragraph 3.4 below).

3.2 Likelihood of confusion and likelihood of association

The Court considered likelihood of confusion comprehensively in ‘Sabèl’ (judgment of 11/11/1997, C-251/95, Sabèl, EU:C:1997:528). The Directive’s equivalents of Article 8(1)(b) CTMR and the eighth recital of the CTMR clearly indicated that likelihood of confusion relates to confusion about the origin of goods/services, but the Court was required to consider what precisely this meant because there were opposing views on the meaning of, and the relationship between, ‘likelihood of confusion’ and ‘likelihood of association’, both of which are referred to in Article 8(1)(b) CTMR.

This issue needed to be resolved because it was argued that likelihood of association was broader than likelihood of confusion as it could cover instances where a later trade mark brought an earlier trade mark to mind but the consumer did not consider that the goods/services had the same commercial origin⁴. Ultimately, the issue in ‘Sabèl’ was whether the wording ‘the likelihood of confusion includes the likelihood of association’ meant that ‘likelihood of confusion’ could cover a situation of association between trade marks that did not give rise to confusion as to origin.

In ‘Sabèl’, the Court found that likelihood of association is not an alternative to likelihood of confusion, but that it merely serves to define its scope. Therefore, a finding of likelihood of confusion requires that there be confusion as to origin.

In Canon (paras 29-30), the Court clarified the scope of confusion as to origin when it held that:

... the risk that the public might believe that the goods and services in question come from the same undertaking or, as the case may be, from economically linked undertakings, constitutes a likelihood of confusion ... there can be no such likelihood where it does not appear that the public could believe that the goods or services come from the same undertaking or, as the case may be, from economically-linked undertakings (emphasis added).

As seen above, likelihood of confusion relates to confusion as to commercial origin including economically-linked undertakings. What matters is that the public believes that the control of the goods or services in question is in the hands of a single undertaking. The Court has not interpreted *economically-linked undertakings* in the context of likelihood of confusion, but it has done so with respect to the free movement of goods/services. In ‘Ideal Standard’ the Court held:

... A number of situations are covered: products put into circulation by the same undertaking, by a licensee, by a parent company, by a subsidiary of the same group, or by an exclusive distributor.

... In all the cases mentioned, control [is] in the hands of a single body: the group of companies in the case of products put into circulation by a

⁴The concept came from Benelux case-law and applied *inter alia* to non-reputed marks.

subsidiary; the manufacturer in the case of products marketed by the distributor; the licensor in the case of products marketed by a licensee. In the case of a licence, the licensor can control the quality of the licensee's products by including in the contract clauses requiring the licensee to comply with his instructions and giving him the possibility of verifying such compliance. The origin that the trade mark is intended to guarantee is the same: it is not defined by reference to the manufacturer but by reference to the point of control of manufacture.

(Judgment of 22/06/1994, C-9/93, Ideal Standard, EU:C:1994:261, § 34 and 37).

Consequently, economic links will be presumed where the consumer assumes that the respective goods or services are marketed under the control of the trade mark proprietor. Such control can be assumed to exist in the case of enterprises belonging to the same group of companies and in the case of licensing, merchandising or distribution arrangements as well as in any other situation where the consumer assumes that the use of the trade mark is normally possible only with the agreement of the trade mark proprietor.

From the premises above, therefore, the Court held that likelihood of confusion covers situations where the consumer directly confuses the trade marks themselves or where the consumer makes a connection between the conflicting signs and assumes that the goods/services covered are from the same or economically-linked undertakings.

Hence, if the perception of a later trade mark merely brings to mind an earlier trade mark, but the consumer does not assume the same commercial origin, this does not constitute likelihood of confusion⁵.

3.3 Likelihood of confusion and enhanced distinctiveness

The distinctiveness of the earlier trade mark has been held to be an important consideration for assessing likelihood of confusion. The main findings of the Court are:

- the more distinctive the earlier trade mark, the greater will be the likelihood of confusion (see Sabèl, para. 24);
- trade marks with a highly distinctive character enjoy broader protection than trade marks with a less distinctive character (see in this regard Canon, para. 18).

One consequence of these findings is that the enhanced distinctiveness of the earlier mark may be a decisive factor towards establishing a likelihood of confusion when the similarity between the signs and/or the goods and services is low (judgment of 11/11/1997, C-251/95, Sabèl, EU:C:1997:528, § 22).

⁵Although such a situation could take unfair advantage of, or be detrimental to, the distinctive character or the reputation of an earlier mark under Article 8(5) CTMR, see the Guidelines Part C, Opposition, Section 5, Trade marks with reputation Article 8(5) CTMR.

3.4 Likelihood of confusion: questions of fact and questions of law

The concept of likelihood of confusion is a legal concept rather than a mere factual evaluation of the rational judgments and emotional preferences that inform the consumer's cognitive behaviour and purchasing habits. Therefore, assessment of likelihood of confusion depends on both legal questions *and* facts.

3.4.1 Fact and law – similarity of goods/services and of signs

Determining the relevant factors for establishing likelihood of confusion and whether they exist is a question of law, that is to say, these factors are established by the relevant legislation, namely, the CTMR and case-law.

For instance, Article 8(1) CTMR establishes that the identity/similarity of goods/services is a condition for likelihood of confusion. The question of the relevant factors for evaluating whether this condition is met is also a question of law. The Court has identified the following factors for determining whether goods/services are similar:

- their nature
- their intended purpose
- their method of use
- whether they are complementary or not
- whether they are in competition or interchangeable
- their distribution channels/points of sale
- their relevant public
- their usual origin.

(See C-39/97 'Canon').

All these factors are legal concepts and determining the criteria to evaluate them is also a question of law. However, it is a question of fact whether, and to what degree, the legal criteria for determining, for instance, 'nature', are fulfilled in a particular case.

By way of example, *cooking fat* does not have the same nature as *petroleum lubricating oils and greases* even though both contain a fat base. *Cooking fat* is used in preparing food for human consumption, whereas *oils and greases* are used for lubricating machines. Considering 'nature' to be a relevant factor in the analysis of similarity of goods/services is a matter of *law*. On the other hand, it is a matter of *fact* to state that cooking fat is used in preparing food for human consumption and that oils and greases are used for machines.

Similarly, when it comes to the comparison of signs, Article 8(1) CTMR establishes that the identity/similarity of signs is a condition for likelihood of confusion. It is a question of law that a conceptual coincidence between signs may render them similar for the purposes of the CTMR, but it is a question of fact, for instance, that the word 'fghryz' does not have any meaning for the Spanish public.

3.4.2 Fact and law – evidence

In opposition proceedings, the parties must allege and, where necessary, prove the facts in support of their arguments. This follows from Article 76(1) CTMR, according to which, in opposition proceedings, the Office shall be restricted in its examination to the facts, evidence and arguments provided by the parties and the relief sought.

Therefore, it is up to the opponent to state the facts on which the claim of similarity is based and to submit supporting evidence. For instance, where *wear-resistant cast iron* is to be compared with *medical implants*, it is not up to the Office to answer the question of whether *wear-resistant cast iron* is actually used for *medical implants*. This must be demonstrated by the opponent as it seems improbable (decision of 14/05/2002, R 0684/2000-4, Tinox).

An admission by the applicant of legal concepts is irrelevant. It does not relieve the Office from analysing and deciding on these concepts. This is not contrary to Article 76(1) CTMR that is binding on the Office *only* as regards the facts, evidence and arguments and does not extend to the legal evaluation of the same. Therefore, the parties may agree as to which facts have been proven or not, but they may not determine whether or not these facts are sufficient to establish the respective legal concepts, such as similarity of goods/services, similarity of the signs, and likelihood of confusion.

Article 76(1) CTMR does not prevent the Office from taking into consideration, on its own initiative, facts that are already notorious or well known or that may be learned from generally accessible sources, for example, that PICASSO will be recognised by EU consumers as a famous Spanish painter (judgments of 22/06/2004, T-185/02, Picaro, EU:T:2004:189; 12/01/2006, C-361/04 P, Picaro, EU:C:2006:25). However, the Office cannot quote *ex officio* new facts or arguments (e.g. reputation or degree of knowledge of the earlier mark, etc.).

Moreover, even though certain trade marks are sometimes used in daily life as generic terms for the goods and services that they cover, this should never be taken as a fact by the Office. In other words, trade marks should never be referred to (or interpreted) as if they were a generic term or a category of goods or services. For instance, the fact that in daily life part of the public refers to 'X' when talking about *yoghurts* ('X' being a trade mark for *yoghurts*) should not lead to using 'X' as a generic term for *yoghurts*.

4 Evaluation of the Factors Taken into Account for Establishing Likelihood of Confusion

4.1 The relevant point in time

The relevant moment for assessing likelihood of confusion is when the opposition decision is taken.

Where the opponent relies on *enhanced distinctiveness* of an earlier trade mark, the conditions for this must have been met on or before the filing date of the CTM application (or any priority date) and they must still be fulfilled at the time of the decision. Office practice is to assume that this is the case, unless there are indications to the contrary.

Where the CTM applicant relies on a *reduced* scope of protection (weakness) of the earlier trade mark, only the date of the decision is relevant.

4.2 List of factors for assessing likelihood of confusion

The likelihood of confusion is assessed in the following steps, taking into account multiple factors:

- Comparison of goods and services
- Relevant public and degree of attention
- Comparison of signs
- Distinctiveness of the earlier mark
- Any other factors
- Global assessment of likelihood of confusion

Each of the above factors have a dedicated chapter in the Guidelines.

Annex I

General principles coming from case-law (these are not direct citations)

<p>Judgment of 11/11/1997, C-251/95, Sabèl, EU:C:1997:528</p> <ul style="list-style-type: none"> - The likelihood of confusion must be appreciated globally, taking into account all factors relevant to the circumstances of the case (para. 22). - The appreciation of the likelihood of confusion depends on numerous elements and, in particular, on the recognition of the trade mark on the market, on the association that the public might make between the two marks and on the degree of similarity between the signs and the goods (para. 22). - The global appreciation of the visual, aural or conceptual similarity of the marks in question must be based on the overall impression given by the marks, bearing in mind their distinctive and dominant components (para. 23). - The average consumer normally perceives a mark as a whole and does not proceed to analyse its various details (para. 23). - The more distinctive the earlier mark, the greater will be the likelihood of confusion (para. 24). - It is not impossible that the conceptual similarity resulting from the fact that two marks use images with analogous semantic content may give rise to a likelihood of confusion where the earlier mark has a particularly distinctive character (para. 24). - However, where the earlier mark is not especially well known to the public and consists of an image with little imaginative content, the mere fact that the two marks are conceptually similar is not sufficient to give rise to a likelihood of confusion (para. 25). - The concept of likelihood of association is not an alternative to likelihood of confusion, but serves to define its scope (para. 18). - The mere association that the public might make between two marks as a result of their analogous semantic content is not in itself a sufficient ground for concluding that there is a likelihood of confusion (para. 26).
<p>Judgment of 29/09/1998, C-39/97, Canon, EU:C:1998:442</p> <ul style="list-style-type: none"> - The risk that the public might believe that the goods or services in question come from the same undertaking or, as the case may be, from economically-linked undertakings, constitutes a likelihood of confusion (para. 29). - By contrast, there can be no such likelihood where the public does not think that the goods come from the same undertaking (or from economically-linked undertakings) (para. 30). - In assessing the similarity of the goods and services, all the relevant factors relating to those goods or services themselves should be taken into account (para. 23). - Those factors include, <i>inter alia</i>, their nature, the purpose for which they are used (the translation 'end users' in the official English language version is not correct) and their method of use, and whether they are in competition with each other or are complementary (para. 23). - A global assessment of the likelihood of confusion implies some interdependence between the relevant factors and in particular a similarity between the marks and between these goods or services. A lesser degree of similarity between the goods may be offset by a greater degree of similarities between the marks and vice versa (para. 17). - Marks with a highly distinctive character, either <i>per se</i> or because of the reputation they possess on the market, enjoy broader protection than marks with a less distinctive character (para. 18). - Registration of a trade mark may have to be refused, despite a lesser degree of similarity between the goods or services covered, where the marks are very similar and the earlier mark, in particular its reputation, is highly distinctive (para. 19). - The distinctive character of the earlier mark and in particular its reputation must be taken into account when determining whether the similarity between the goods and services is enough to give rise to the likelihood of confusion (para. 24). - There may be a likelihood of confusion, even if the public thinks that these goods have different places of production (para. 30).

Judgment of 22/06/1999, C-342/97, Lloyd Schuhfabrik, EU:C:1999:323

- The level of attention of the average consumer, who is deemed to be reasonably well-informed and reasonably observant and circumspect, varies according to the category of the goods and services in question (para. 26).
- However, account should be taken of the fact that the average consumer only rarely has the chance to make a direct comparison between the different marks and must place his trust in the imperfect picture of them that he has kept in his mind (para. 26).
- When assessing the degree of visual, phonetic and conceptual similarity it can be appropriate to evaluate the importance attached to each by reference to the category of goods and the way they are marketed (para. 27).
- It is possible that mere aural similarity could lead to likelihood of confusion (para. 28).
- In determining the distinctive character of a mark and, accordingly, in assessing whether it is highly distinctive, an overall assessment needs to be made of the greater or lesser capacity of the mark to identify the goods and services for which it has been registered as coming from a particular undertaking (para. 22).
- In making that assessment, account should be taken, in particular, of the inherent characteristics of the mark, including the fact that it does or does not contain an element descriptive of the goods or services for which it has been registered; the market share held by the mark; how intensive, geographically widespread and long-standing use of the mark has been; the amount invested by the undertaking in promoting the mark; the proportion of the relevant section of the public who, because of the mark, identifies the goods and services as originating from a particular undertaking; and statements from chambers of commerce and industry or other trade and professional associations (para. 23).
- It is not possible to state in general terms, for example by referring to given percentages relating to the degree of recognition attained by the mark within the relevant section of the public, when a mark has a strong distinctive character (para. 24).

Judgment of 22/06/2000 C-425/98, Marca, EU:C:2000:339

- The reputation of a mark does not give grounds for presuming the existence of a likelihood of confusion simply because of the existence of a likelihood of association in the strict sense (para. 41).
- Article 5(1)(b) of the Directive cannot be interpreted as meaning that where:
 - a trade mark has a particularly distinctive character, either *per se* or because of the reputation it enjoys with the public, and
 - a third party, without the consent of the proprietor of the mark, uses, in the course of trade in goods or services that are identical with, or similar to, those for which the trade mark is registered, a sign that so closely corresponds to the mark as to give the possibility of its being associated with that mark,the exclusive right enjoyed by the proprietor entitles him to prevent the use of the sign by that third party if the distinctive character of the mark is such that the possibility of such association giving rise to confusion cannot be ruled out (emphasis added) (para. 42).

Judgment of 06/10/2005, C-120/04, Thomson Life, EU:C:2005:594

- Where the goods or services are identical there may be a likelihood of confusion on the part of the public where the contested sign is composed by juxtaposing the company name of another party and a registered mark that has normal distinctiveness and which, without alone determining the overall impression conveyed by the composite sign, still has an independent distinctive role therein (para. 37).

**GUIDELINES FOR EXAMINATION IN THE
OFFICE FOR HARMONIZATION IN THE
INTERNAL MARKET (TRADE MARKS AND
DESIGNS) ON COMMUNITY TRADE MARKS**

PART C

OPPOSITION

SECTION 2

**DOUBLE IDENTITY AND
LIKELIHOOD OF CONFUSION**

CHAPTER 2

**COMPARISON OF
GOODS AND SERVICES**

Table of Contents

1	Introduction.....	6
1.1	Relevance	6
1.2	Nice Classification: a starting point.....	7
1.2.1	Its nature as a classification tool.....	7
1.2.2	Its structure and methodology	7
1.2.3	Conclusions to be drawn from the structure of the Nice Classification	8
1.2.4	Changes in the classification of goods/services.....	8
1.3	The Similarity Tool (ETMDN) for the comparison of goods/services.....	9
1.4	Definition of goods and services (terminology).....	9
1.4.1	Goods	9
1.4.2	Services	10
1.4.3	Products.....	10
1.5	Determining the goods/services	10
1.5.1	The correct wording.....	10
1.5.1.1	Community trade marks	11
1.5.1.2	Earlier national marks and international registrations.....	11
1.5.2	The relevant scope	11
1.5.3	The meaning of goods/services.....	13
1.6	Objective approach	13
1.7	Statement of reasons	14
2	Identity.....	14
2.1	General principles	14
2.2	Identical terms or synonyms	15
2.3	Terms included in general indication or broad category.....	16
2.3.1	The earlier mark includes the goods/services of the contested mark	16
2.3.2	The contested mark includes the goods/services of the earlier mark	16
2.4	Overlap	18
2.5	Practice on the use of general indications of the class headings	19
3	Similarity of Goods and Services.....	20
3.1	General principles	20
3.1.1	Similarity factors	20
3.1.2	Defining relevant factors.....	21
3.2	The specific similarity factors	22
3.2.1	Nature	22
3.2.1.1	Indicative value of class headings and categories.....	22
3.2.1.2	Features of the goods defining their nature	23
3.2.1.3	Nature of services	24
3.2.1.4	Nature of goods versus nature of services	24
3.2.2	Intended purpose.....	24
3.2.3	Method of use.....	25
3.2.4	Complementarity	26
3.2.4.1	Use in combination: not complementary	27

3.2.4.2	Ancillary goods/services: not complementary.....	28
3.2.4.3	Raw materials, parts, components and fittings: not complementary.....	28
3.2.5	In competition	29
3.2.6	Distribution channel	29
3.2.7	Relevant public	30
3.2.8	Usual origin (producer/provider).....	31
3.2.8.1	Features defining a common origin	32
3.3	Relation between different factors	33
3.3.1	Interrelation of factors.....	33
3.3.2	Importance of each factor.....	34
3.3.3	Different types of comparisons: goods versus goods, services versus services and goods versus services.....	35
3.3.4	Degree of similarity.....	35
Annex I	37
1	Parts, components and fittings	37
2	Raw material and semi-processed goods	37
3	Accessories	38
4	Installation, maintenance and repair services	39
5	Advisory services	39
6	Rental and leasing.....	40
6.1	Rental/leasing versus related services	41
6.2	Rental/leasing versus goods	41
Annex II	42
1	Chemicals, pharmaceuticals and cosmetics.....	42
1.1	Chemicals (Class 1) versus chemical products (Classes 3 and 5)	42
1.2	Pharmaceuticals versus pharmaceuticals.....	42
1.3	Pharmaceuticals versus dietetic substances adapted for medical use.....	44
1.4	Pharmaceuticals versus cosmetics	44
1.5	Pharmaceuticals versus services	44
2	Automobile industry.....	44
3	Electric apparatus/instruments	45
4	Fashion and textile industries	45
4.1	Raw or semi-processed materials versus finished goods	45
4.2	Textile goods (Class 24) versus clothing (Class 25).....	46
4.3	Clothing, footwear and headgear (Class 25)	46

4.4	Fashion accessories	46
4.5	Sports clothing, footwear and headgear (Class 25) versus sporting and gymnastic articles (Class 28)	47
4.6	Fashion design (Class 42) and tailoring services (Class 40) versus clothing (Class 25).....	48
5	Food, beverages and restaurant services	48
5.1	Ingredients of prepared food	48
5.2	Main ingredient.....	48
5.3	Non-alcoholic beverages (Class 32) versus alcoholic beverages (except beers) (Class 33)	49
5.4	Beers (Class 32), alcoholic beverages (except beers) (Class 33)	49
5.5	Provision of food and drinks versus food and drinks	49
6	Services to support other businesses.....	50
7	Retail services	52
7.1	Retail services versus any product: dissimilar	53
7.2	Retail services of specific goods versus same specific goods: similar to a low degree.....	53
7.3	Retail services of specific goods versus different or similar specific goods: dissimilar.....	54
7.4	Retail services versus retail services or retail services of specific goods: identical.....	54
7.5	Retail services of specific goods versus retail services of other specific goods: similar.....	54
7.6	Services to which the same principles apply	54
7.7	Services to which the same principles do not apply	54
8	Financial services.....	55
8.1	Banking services (Class 36) versus insurance services (Class 36).....	55
8.2	Real estate affairs (Class 36) versus financial affairs (Class 36)	56
8.3	Credit cards (Class 9) versus financial services (Class 36)	56
9	Transport, packaging and storage	57
9.1	Transport of goods (Class 39) versus any product	57
9.2	Packaging and storage of goods (Class 39) versus any product	57
10	Information Technology.....	57
10.1	Computers versus software	57
10.2	Software versus apparatus that use software.....	58
10.3	Software, downloadable ‘apps’ and downloadable electronic publications	58

10.4 Specific software versus specific software	59
10.5 Computers and software (Class 9) versus computer programming (Class 42)	59
10.6 Apparatus for recording, transmission, reproduction of sound or images, computers and software (Class 9) versus telecommunication services (Class 38)	59

1 Introduction

1.1 Relevance

The comparison of goods and services is primarily of relevance for the assessment of identity according to Article 8(1)(a) CTMR and likelihood of confusion according to Article 8(1)(b) CTMR. One of the main conditions for Article 8(1)(a) CTMR is the identity of goods/services, while Article 8(1)(b) CTMR requires the identity or similarity of goods/services. Consequently, if all goods/services are found to be dissimilar, one of the conditions contained in Article 8(1) CTMR is not fulfilled and the opposition must be rejected without addressing the remaining sections of the decision¹.

The criteria for the assessment of identity or similarity might also play a role when proof of use has been requested and the evidence has to be assessed in order to conclude whether the opponent showed use for the goods/services as registered. In particular, it is important to determine whether the goods and services for which the mark has been used belong to the category of goods and services for which the trade mark was registered. This is because, under Article 42(2) CTMR, proof of use for a good or service that is merely similar to the good or service registered does not prove use for the registered good or service (see the Guidelines, Part C, Opposition, Section 6: Proof of Use).

Likewise, evidence of use of goods/services might also be relevant when examining a claim to enhanced distinctiveness. In such cases it is often necessary to examine whether the enhanced distinctiveness covers goods/services for which the earlier trade mark enjoys protection and which are relevant for the specific case, that is to say, which have been considered to be identical or similar to the goods/services of the contested CTM (see the Guidelines, Part C, Opposition, Section 2: Identity and Likelihood of Confusion, Chapter 4, Distinctiveness).

Furthermore, the outcome of the comparison of goods/services plays an important role for defining the part of the public for whom likelihood of confusion is analysed because the relevant public is that of the goods/services found to be identical or similar (see the Guidelines, Part C, Opposition, Section 2, Identity and Likelihood of Confusion, Chapter 6, Relevant Public and Degree of Attention).

The comparison of goods/services may also be relevant under Article 8(3) CTMR, which requires the identity or 'close relation or equivalence in commercial terms' of goods/services (see the Guidelines, Part C, Opposition, Section 3, Unauthorised Filing by Agents of the TM Proprietor – Article 8(3) CTMR), and under the applicable provisions of national law under Article 8(4) CTMR, since identity or similarity of the goods/services is often a condition under which the use of a subsequent trade mark may be prohibited (see the Guidelines, Part C, Opposition, Section 4: Rights under Article 8(4) CTMR). Furthermore, under Article 8(5) CTMR the degree of similarity or dissimilarity between the goods or services is a factor that must be taken into account when establishing whether or not the consumer will perceive a link between the marks. For example, the goods or services may be so manifestly dissimilar that use of the later mark on the contested goods or services is unlikely to bring the earlier mark to the

¹ Equally, the comparison of goods and services is of relevance in invalidity proceedings, since pursuant to Article 53(1)(a) CTMR a registered Community trade mark is declared invalid where the conditions set out in Article 8(1) CTMR are fulfilled.

mind of the relevant public (see the Guidelines, Part C, Opposition, Section 5, Trade Marks with Reputation (Article 8(5) CTMR)).

1.2 Nice Classification: a starting point

The goods/services to be compared are categorised according to the Nice Classification. Currently the Nice Classification consists of 34 classes (1-34) to categorise goods and 11 classes (35-45) to categorise services.

1.2.1 Its nature as a classification tool

The Nice Classification was set up with the aim of harmonising national classification practices. Its first edition entered into force in 1961. Although it has undergone several revisions, it sometimes lags behind the rapid changes in product developments in the markets. Furthermore, the wording of the headings is sometimes unclear and imprecise.

Rule 2(4) CTMIR explicitly states that the Nice Classification serves purely administrative purposes and, as such, does not provide in itself a basis for drawing conclusions as to the similarity of goods and services.

The fact that the respective goods or services are listed in the same class of the Nice Classification is not, in itself, an indication of similarity.

Examples

- *Live animals* are dissimilar to *flowers* (Class 31).
- *Advertising* is dissimilar to *office functions* (Class 35).

The fact that two specific goods/services fall under the same general indication of a class heading does not per se make them similar, let alone identical: *cars* and *bicycles* – although both fall under *vehicles* in Class 12 – are considered dissimilar.

Furthermore, goods/services listed in different classes are not necessarily considered dissimilar (judgment of 16/12/2008, T-259/06, Manso de Velasco, EU:T:2008:575, § 30-31).

Examples

- *Meat extracts* (Class 29) are similar to *spices* (Class 30).
- *Travel arrangement* (Class 39) is similar to *providing temporary accommodation* (Class 43).

1.2.2 Its structure and methodology

Notwithstanding Rule 2(4) CTMIR, the classification may serve as a tool to identify the common characteristics of certain goods/services.

Many classes of the Nice Classification are structured according to factors such as function, composition and/or purpose of use which may be relevant in the comparison of goods/services. For example:

- Class 1 comprises chemical goods primarily based on their chemical properties (nature), rather than on their specific application. In contrast, Class 3 covers all items that are either cleaning preparations or for personal hygiene or beautification. Although they can by their nature also be classified as chemical products, it is their specific purpose that allows a distinction and thus a different classification.
- Equally, it is because of their nature that most items made of leather are classified in Class 18, whereas clothing made of leather falls under Class 25 since it serves a very specific purpose, namely for wear by people and as protection from the elements.

1.2.3 Conclusions to be drawn from the structure of the Nice Classification

The structure of the class headings is not uniform and does not follow the same logic. Some classes consist of only one general indication that by its definition already covers nearly all the goods/services included in this class (Class 15 *musical instruments*; Class 38 *telecommunications*). Some others include many general indications, some being very broad and others very specific. For example, the heading of Class 9 includes more than 30 terms, ranging from *scientific apparatus and instruments* to *fire-extinguishing apparatus*.

Exceptionally, there are class headings containing general indications that include another general indication and are thus identical.

Example: *materials for dressing* in Class 5 include *plasters* in Class 5.

Other specific indications in a class heading are only mentioned to clarify that they do not belong to another class.

Example: *Adhesives used in industry* are included in *chemicals used in industry* in Class 1. Its reference is mainly thought to distinguish them from adhesives classified in Class 16, which are for stationery or household purposes.

To conclude: the Nice Classification gives indications that can be used in the assessment of identity or similarity of goods/services. However, its structure and content is not coherent. Therefore, each heading or specific term has to be analysed according to the specific class under which it is classified. As stated before, the Nice Classification mainly serves to categorise the goods/services for administrative purposes and is not decisive for their comparison.

1.2.4 Changes in the classification of goods/services

Normally, with each revision of the Nice Classification there are changes in the classification of goods/services (in particular the transfer of goods/services between various classes) or in the wording of headings. In such cases the list of goods/services of both the earlier and the contested mark must be interpreted according to the edition of the Nice Classification at its moment of filing.

Example

- *Legal services* were transferred from Class 42 to Class 45 with the eighth edition of the Nice Classification. The nature of these services has not changed. *Vending machines* were transferred from Class 9 to 7 with the 10th edition of the Nice Classification, since a vending machine is basically a powered machine and as such was considered more appropriately classified in Class 7 with other machinery. However, since the nature of these goods has not changed, *vending machines* classified in different classes due to different filing dates of the respective applications are regarded as identical.

1.3 The Similarity Tool (ETMDN) for the comparison of goods/services

The [Similarity Tool](#) for the comparison of goods and services is a search tool to help and support examiners in assessing the similarity of goods and services. The Similarity Tool serves to harmonise practice on the assessment of similarity of goods and services and to guarantee coherence of opposition decisions. The Similarity Tool must be followed by examiners.

The Similarity Tool is based on the comparison of specific pairs of goods and services. A 'pair' compares two 'terms'. A 'term' consists of a class number from the Nice Classification (1-45) and a textual element, that is to say, a specific good or service (including general categories of goods and services, such as 'clothing' or 'education'). There are five possible results of the search: identity, high degree of similarity, similarity, low degree of similarity and dissimilarity. For each of the degrees of similarity, the tool indicates which criteria lead to each result.

The Similarity Tool is constantly updated and if necessary revised in order to create a comprehensive and reliable source of reference.

Since the tool gives, or will give, answers to specific comparisons, the Guidelines concentrate on defining the general principles and their application in practice.

1.4 Definition of goods and services (terminology)

1.4.1 Goods

The CTMR does not give a definition of goods and services. Although the Nice Classification gives some general explanations to this effect in its introductory remarks, it refrains from clearly setting criteria for the distinction between goods and services.

In principle, the word 'goods' refers to any kind of item that may be traded. Goods comprise raw materials (unprocessed plastics in Class 1), semi-finished products (plastics in extruded form for use in manufacture in Class 17) and finished products (plastic household containers in Class 21). They include natural and manufactured goods, such as agricultural products in Class 31 and machines and machine tools in Class 7.

However, sometimes it is not clear whether goods only comprise tangible physical products as opposed to services, which are intangible. The definition and thus the scope of protection are particularly relevant when it comes to 'goods' such as

‘electricity’, which are intangible. This question is already answered during the examination on classification and will usually not cause any problems in the comparison of goods and services.

1.4.2 Services

A service is any activity or benefit that one party can offer to another that is intangible and does not result in the transfer of ownership of any physical object. In contrast to goods, a service is always intangible.

Importantly, services comprise economic activities provided to third parties.

- Advertising one’s own goods is not a service but running an advertisement agency (designing advertisement campaigns for third parties) is. Similarly *shop window dressing* is only a service when provided for third parties, not when done in one’s own shop.
- Selling or distributing one’s own goods is not a service. *Retail services* are meant to cover the services around the actual sale of goods, such as providing the customer with an opportunity to conveniently see, compare or test the goods. For more detailed information, see Annex II, paragraph 7, Retail services.

One indication for an activity to be considered a service under trade mark law is its independent economic value, that is to say, that it is usually provided in exchange for some form of (monetary) compensation. Otherwise, it could be a mere ancillary activity provided together with or after the purchase of a specific good.

Example

- Delivery, including the transport of furniture that has previously been purchased (either in a physical establishment or online), is not an independent service falling under *transport services* in Class 39.

However, the intention to make profit is not necessarily a criterion for defining whether an activity can qualify as a ‘service’ (judgment of 09/12/2008, C-442/07, Radetzky, EU:C:2008:696, § 16-18). It is more a question of whether the service has an independent market area and targeted public rather than the way or form in which compensation is made.

1.4.3 Products

In common parlance the term ‘products’ is used for both goods and services, e.g. ‘financial products’ instead of financial services. Whether terms in common parlance are described as ‘products’ is immaterial for them being classified as goods or services.

1.5 Determining the goods/services

1.5.1 The correct wording

As a preliminary matter, the correct wording of the lists of goods/services under consideration must be identified.

1.5.1.1 Community trade marks

An application for a CTM will be published in all the official languages of the Community (Article 120(1) CTMR). Likewise, all entries in the Register of CTMs will be in all these languages (Article 120(2) CTMR). Both applications and entries in the Register are published in the CTM Bulletin (Rule 85(1) and (2) CTMR).

In practice, occasional discrepancies may be found between:

- the translation of the wording of the list of goods and/or services of a CTM (application or registration) published in the CTM Bulletin, and
- the original wording as filed.

In cases of such a discrepancy, the definitive version of the list of goods and services is:

- the text in the first language if the first language is one of the five languages of the Office.
- the text in the second language indicated by the applicant (see Article 120(3) CTMR) if the first language of the application is not one of the five languages of the Office.

This applies regardless of whether the CTM (or CTM application) is the earlier right or the contested application.

1.5.1.2 Earlier national marks and international registrations

The list of goods and services of the earlier marks on which the opposition is based must be submitted in the language of the opposition proceedings (Rule 19(3) CTMR). The Office does not require any certified translation and accepts simple translations, drawn up by the opponent or its representative. The Office normally does not make use of its faculty under Rule 98(1) CTMR, second sentence, to require the translation to be certified by a sworn or official translator. Where the representative adds a declaration that the translation is true to the original, the Office will in principle not question this. The other party may, however, question the correctness of the translation during the adversarial part of the proceedings. (See the Guidelines, Part C, Opposition, Section 1, Procedural Matters).

For international registrations under the Madrid Agreement or Protocol, the language in which the international registration was registered is definitive (French, English or Spanish). However, where the language of the opposition procedure is not the language of the international registration, a translation must be supplied as for earlier national marks.

1.5.2 The relevant scope

The comparison of the goods and services must be based on the wording indicated in the respective lists of goods/services. Any actual or intended use not stipulated in the

list of goods/services is not relevant for the comparison since this comparison is part of the assessment of likelihood of confusion in relation to the goods/services on which the opposition is based and directed against; it is not an assessment of actual confusion or infringement (judgment of 16/06/2010, T-487/08, Kremezin, EU:T:2010:237, § 71).

However, if proof of use of the earlier mark is validly requested and the submitted evidence is sufficient only for part of the goods/services listed, the earlier mark is deemed to be registered for only those goods/services (Article 42(2) CTMR), and consequently the examination is restricted to those goods/services (see the Guidelines, Part C, Opposition, Section 6, Proof of Use).

Moreover, in the case of the earlier mark, only the goods and services on which the opposition is validly based are pertinent. Hence, no account will be taken of the goods/services:

- that cannot be taken into account for reasons of admissibility,
- that have not been properly substantiated (e.g. only a partial translation of the list of goods/services was filed), or
- on which the opposition is not, or is no longer, based.

Similarly, only those goods and services of the contested application against which the opposition is directed are taken into consideration. Consequently, restrictions during the proceedings of either the list of goods/services of the application, or the goods/services on which the opposition is based, or of both, will limit the goods and services to be compared.

Furthermore, an analysis of the wording of the list of goods/services might be required to determine the scope of protection of those goods and services. This is especially true where terms such as *in particular*, *namely*, or *equivalents* are used in order to show the relationship of an individual product with a broader category.

The term ***in particular*** (or *for example*, *such as*, *including* or other equivalent) indicates that the specific goods/services are only examples of items included in the category, and that protection is not restricted to them. In other words, it introduces a non-exhaustive list of examples (on the use of *in particular* see the reference in judgment of 09/04/2003, T-224/01, Nu-tride, EU:T:2003:107).

On the other hand, the term ***namely*** (or *exclusively* or other equivalent) is exclusive and restricts the scope of the registration only to the specifically listed goods.

For example, in the case of *chemicals used in industry, namely raw materials for plastics* only the *raw materials for plastics* need to be compared with the goods of the other mark.

It should be recalled that the use of commas in the list of goods/services serves to separate items within the same or a similar category. The use of a semicolon means a separation between terms. The separation of terms by different punctuation can lead to changes in their meaning and may lead to a different assessment when comparing the goods/services. See the Guidelines, Part B, Examination, Section 3, Classification for more information on punctuation in lists of goods and services.

For example, in ‘*computer software for use with industrial machines; fire extinguishers*’ in Class 9, the inclusion of a semicolon means that the term ‘*fire extinguishers*’ must be considered as an independent category of goods, regardless of whether the intention was to protect computer software to be used in the field of industrial machines and fire extinguishers.

1.5.3 The meaning of goods/services

Once the wording of the goods and services to be considered has been identified, their meaning must be determined.

In some cases the exact meaning is immediately obvious from the list of goods and/or services of the marks where a more or less detailed description of the goods and services will often be given. For example, the wording *belts, being articles of clothing* excludes by definition safety or industrial belts.

In cases of doubt about the exact meaning of the terms used in the list of goods and/or services, these terms have to be interpreted both in the light of the Nice Classification and from a commercial perspective.

Therefore, *belts* in Class 25 are due to their classification *articles of clothing*.

Where the meaning of terms in a semantic context, a commercial context and/or under the Nice Classification are ambiguous or leave some doubts, the meaning they have under the Nice Classification prevails.

Clothing, for instance, refers to ‘clothes collectively’ (see e.g. *Oxford English Dictionary*) and thus to items worn to cover the body, such as shirts, dresses, pants, etc. Although the definition found in standard dictionaries does not explicitly exclude *footwear*, the fact that it appears in the Nice Classification as a separate item in the same Class 25 leads to the conclusion that *clothing* and *footwear* are not identical but similar (confirmed by judgment of 13/07/2004, T-115/02, ‘a’ in a black ellipse, EU:T:2004:234, § 26).

However, that does not mean that two general indications of one class heading can never be considered identical. As mentioned above, the structure of the class headings is not uniform. Some general indications included in the class headings may encompass others.

Example

- *Meat* and *poultry* are identical (Class 29).

1.6 Objective approach

The comparison of the goods/services in question must be made *without* taking into account the degree of similarity of the conflicting signs or the distinctiveness of the earlier mark. It is only in the overall assessment of a decision that the examiners will take into account all the relevant factors.

The classification of the goods or services is not conclusive, because similar goods/services may be classified in different classes, whereas dissimilar goods/services may fall within the same class.

Identity or similarity of the goods/services in question must be determined on an objective basis.

It is necessary to base the findings on the realities of the marketplace, i.e. established customs in the relevant field of industry or commerce. These customs, especially trade practices, are dynamic and constantly changing. For instance, mobile phones nowadays combine many functions such as being communication tools as well as photographic apparatus.

The degree of similarity of the goods and services is a matter of law, which must be assessed *ex officio* by the Office even if the parties do not comment on it². However, the Office's *ex officio* examination is restricted to well-known facts, that is to say, 'facts that are already well known or which may be learned from generally accessible sources', which excludes facts of a highly technical nature (judgment of 03/07/2013, T-106/12, Alpharen, EU:T:2013:340, § 51). Consequently, what does not follow from the evidence/arguments submitted by the parties or is not commonly known should not be speculated on or extensively investigated *ex officio* (judgment of 09/02/2011, T-222/09, Alpharen, EU:T:2011:36, § 31-32). This follows from Article 76(1) CTMR, according to which, in opposition proceedings, the Office is restricted in its examination to the facts, evidence and arguments provided by the parties and the relief sought. (See also the Guidelines, Part C, Opposition, Section 2, Double Identity and Likelihood of Confusion, Chapter 1, General Principles).

1.7 Statement of reasons

The examiner is required to reason the outcome of the comparison (identity, similarity or dissimilarity) for each of the individual goods and services specified in the application for registration. However, the examiner may use only general reasoning for groups of the goods or services concerned as long as the goods or services present analogous characteristics (see by analogy order of 18/03/2010, C-282/09 P, P@yweb card / Payweb card, EU:C:2010:153, § 37-38, judgments of 12/04/2011, T-28/10, Euro automatic payment, EU:T:2011:158, § 54; 17/10/2013, C-597/12 P, Zebexir, EU:C:2013:672, § 26-27).

2 Identity

2.1 General principles

Identity is generally defined as 'the quality or condition of being the same in substance, composition, nature, properties, or in particular qualities under consideration' (*Oxford English Dictionary*).

Identity exists not only when the goods and services completely coincide (the same terms or synonyms are used), but also when and insofar as the contested mark's goods/services fall within the broader category of the earlier mark, or when and insofar

² Judgment of 16/01/2007, T-53/05, Calvo, EU:T:2007:7, § 59.

as – conversely – a broader term of the contested mark includes the more specific goods/services of the earlier mark. There might also be identity when two broad categories under comparison coincide partially ('overlap'). Hence a distinction can be made between cases of 'full identity' and 'partial identity'.

Identity should not be established on the basis of similarity factors (see paragraph 3.1.1 below).

2.2 Identical terms or synonyms

Identity between the goods/services in dispute must be established on the basis of the wording of the relevant parts of the lists of goods and/or services of the two marks that have been identified in accordance with the principles set out above. Identity is obvious where the goods/services to be compared are listed in exactly the same terms.

Example

- *Vehicles* are identical to *vehicles*.

Where this is not the case, the terms of the respective lists of goods and/or services must be interpreted in order to show that they are in fact synonyms, i.e. that their meaning is the same. The interpretation can be made based on dictionary definitions, expressions from the Nice Classification and in particular taking into account the commercial perspective.

Examples

- *Bicycle* is a synonym for *bike*. The goods are identical.
- The meaning of the words *smokers' articles* in Class 34 refers to individual objects that are used in close connection with tobacco or tobacco products. In former editions of the Nice Classification these products were called *smokers' requisites*. Therefore, despite a different term used in the current heading, these goods are identical.
- From a commercial perspective, *health spa services* and *wellness services* are the same and are therefore identical.

However, if an identical wording is used but the goods are classified in different classes, this generally means that these goods are not identical.

Examples

- *Drills* (machine tools) in Class 7 are not identical to *drills* (hand tools) in Class 8.
- *Lasers* (not for medical treatment) in Class 9 are not identical to *lasers* (for curative purposes) in Class 10.

Even though they might be similar, the classification in different classes indicates that they have a different nature, purpose or method of use, etc.

The same reasoning does not apply if the different classification is only due to a revision of the Nice Classification or where it is clear that the goods/services are wrongly 'classified' due to an obvious mistake.

Examples

- *Playing cards* (Class 16 – 7th edition) are identical to *playing cards* (Class 28 – 10th edition).
- *Pharmaceutical preparations* (Class 15 – obvious typing error) are identical to *pharmaceutical preparations* (Class 5).

2.3 Terms included in general indication or broad category

2.3.1 The earlier mark includes the goods/services of the contested mark

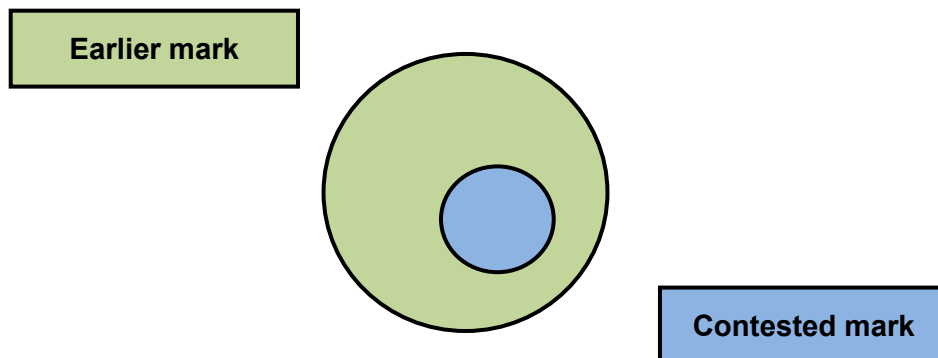

Where the list of goods/services of the earlier right includes a general indication or a broad category that covers the goods/services of the contested mark in their entirety, the goods/services will be identical (judgment of 17/01/2012, T-522/10, Hell, EU:T:2012:9, § 36).

Examples

- *Temporary accommodation* (earlier right, Class 43) includes *youth hostel services* (contested mark, Class 43). Therefore, the services are identical.
- *Pasta* (earlier right, Class 30) includes *spaghetti* (contested mark, Class 30). The conflicting goods are considered identical.

2.3.2 The contested mark includes the goods/services of the earlier mark

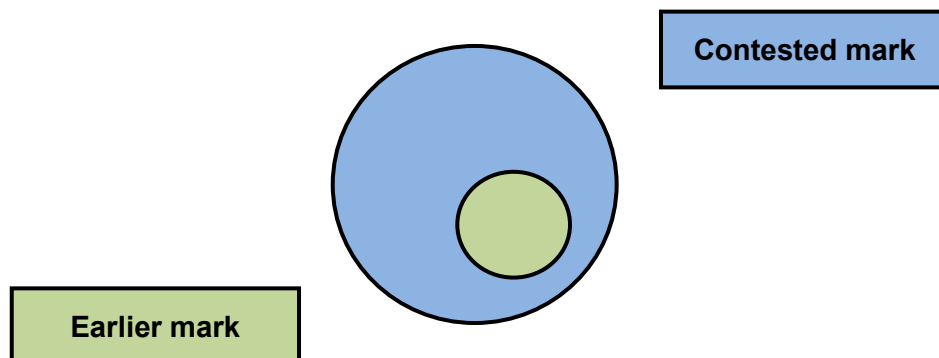

If the goods/services designated in the earlier mark are covered by a general indication or broad category used in the contested mark, these goods/services must be

considered identical since the Office cannot dissect *ex officio* the broad category of the applicant's/holder's goods/services (judgment of 07/09/2006, T-133/05, Pam-Pim's Baby-Prop, EU:T:2006:247, § 29).

Examples

- The earlier mark's *jeans* (Class 25) are included in *articles of clothing* (contested mark, Class 25). The goods are considered identical.
- The earlier mark's *bicycles* (Class 12) are included in *vehicles* (contested mark, Class 12). The goods are considered identical.

The applicant/holder may however restrict the list of goods/services in a way that excludes identity, but could still lead to similarity (judgment of 24/05/2011, T-161/10, E-Plex, EU:T:2011:244, § 22).

- The earlier mark's *jeans* (Class 25) are included in *articles of clothing* (Class 25). The applicant/holder restricts the specification to *articles of clothing, excluding jeans*. The goods are no longer identical but remain similar.
- The earlier mark's *bicycles* (Class 12) are included in *vehicles* (contested mark, Class 12). The applicant/holder restricts the specification to *vehicles, namely automobiles*. The goods are no longer identical or similar.

If the applicant/holder does not restrict the list of goods/services, or does so in an insufficient way, the Office will treat the contested mark's general indication or broad term/category as a single unit and find identity.

If the contested mark covers a general indication or a broad term/category as well as specific items that fall under that general indication or broad term/category, all of these will need to be compared with the specific earlier goods/services. The result of identity found with the general indication or broad term/category does not automatically extend to the specific items.

Example

- The contested mark covers *vehicles* (general indication) as well as *bicycles, aircraft, trains* (included in vehicles). Where the earlier mark is protected for *bicycles*, identity will be found with respect to *vehicles* and to *bicycles* but not for *aircraft or trains*.

However, if the contested mark covers a general indication or broad term/category and specific terms that are not listed independently but only as examples, the comparison differs insofar as only the general indication or broad term/category has to be compared.

Example

- The contested mark covers *vehicles, in particular bicycles, aircraft, trains*. The earlier mark is protected for *bicycles*. The goods in conflict are considered identical.

The applicant/holder can avoid this result by deleting the general indication *vehicles*, the expression *in particular*, and the specific category *bicycles*.

Where the list of goods and/or services of the contested mark reads: *vehicles, namely bicycles, aircraft, trains*, the comparison differs insofar as only the specific items have to be compared. In this case only the contested *bicycles* are identical to the earlier goods.

2.4 Overlap

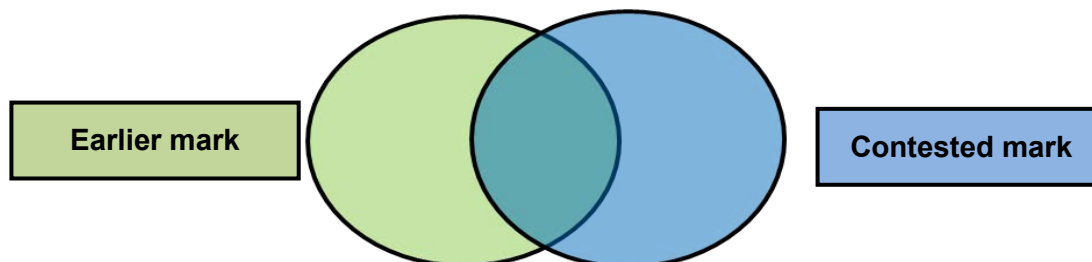

If two categories of goods/services coincide partially ('overlap') there might be identity if:

- a. they are classified in the same class;
- b. it is impossible to clearly separate the two goods/services.

Examples

Earlier goods	Contested goods	Coinciding part
<i>Outdoor clothing for women.</i>	<i>Clothing made of leather</i>	Outdoor clothing for women made of leather
<i>Components and spare parts for land vehicles</i>	<i>Vehicle seats</i> ³	Seats for land vehicles
<i>Bread</i>	<i>Long-life bakery products.</i>	Long-life bread
<i>Electric kitchen utensils</i>	<i>Thermometers</i> ⁴	Electric kitchen thermometers
<i>Soap</i>	<i>Cleaning preparations</i>	Soaps for cleaning purposes
<i>Scientific instruments</i>	<i>Optical instruments</i>	Scientific optical instruments, e.g. microscopes
<i>Online banking services</i>	<i>Commercial banking services</i>	Online commercial banking services

In such cases, it is impossible for the Office to filter these goods from the abovementioned categories. Since the Office cannot dissect *ex officio* the broad category of the applicant's/holder's goods, they are considered to be identical.

In the fifth example given above, the outcome changes of course if *soap* is limited to *soaps for personal use*. In this case the goods are no longer included in the heading *cleaning preparations* in Class 3 since the latter is only for household use.

³ Judgment of 09/09/2008, T-363/06, Magic seat, EU:T:2008:319, § 22.

⁴ Judgment of 19/01/2011, T-336/09, Topcom, EU:T:2011:10, § 34.

2.5 Practice on the use of general indications of the class headings

Following the President's Communication No 2/12 of 20/06/2012 the Office does not object to the use of any of the general indications of the class headings provided that this identification is sufficiently clear and precise⁵.

According to the aforesaid Communication the Office interprets the use of all the general indications in the class heading as follows:

- **CTMs applied for on or before 20/06/2012:** As regards CTMs registered and applications filed before the entry into force of the above Communication⁶ that use all the general indications listed in the class heading of a particular class, the Office considers that the intention of the applicant was to cover not only the literal meaning of the general indications but also the goods or services included in the alphabetical list of that class in the edition of the Nice Classification in force at the time of filing.

In judgment of 31/01/2013, T-66/11 Babilu, EU:T:2013:48, § 49-50, the General Court confirmed this interpretation of the scope of protection of earlier CTMs.

- **CTMs applied for on or after 21/06/2012:** An applicant for a trade mark who uses all the general indications of a particular class heading of the Nice Classification to identify the goods or services for which the protection of the trade mark is sought must specify whether its application for registration is intended to cover all the goods or services included in the alphabetical list of the particular class concerned or only some of those goods or services. If the applicant does not indicate such an intention the general indications (provided that these respect the requirements of clarity and precision) will be interpreted following a literal approach.

OHIM and all national trade mark offices of the European Union issued a Common Communication on the implementation of the 'IP Translator' judgment (in the 'Common Communication [on the implementation of IP Translator](#)'). According to that Communication, OHIM interprets the scope of protection of national marks containing class headings as follows:

- **Earlier national trade marks filed before the 'IP Translator' judgment:** In principle, OHIM accepts the filing practice of all national trade mark offices in the European Union. National trade marks filed before the 'IP Translator' judgment have the scope of protection awarded by the national office(s). The majority of the national offices interpret the class headings of their marks literally. For those marks, OHIM also interprets the class headings on the basis of the natural and usual meaning of each general indication.

⁵ See in this respect 'Common Communication on the Common practice on the General Indications of the Nice Class headings'.

⁶ This Communication entered into force on 21/06/2012.

- Only eight national trade mark offices do **not** interpret the class headings of their own marks filed before the ‘IP Translator’ judgment on the basis of their natural and usual meaning: **Bulgaria, Finland, Greece, Hungary, Italy, Lithuania, Malta and Romania** (see Table 1 of the Common Communication). OHIM interprets those national marks as covering the class headings plus the alphabetical list of the Nice edition at the time of filing (even if the national office interprets the class heading to cover all goods and services in the class).
- **Earlier national marks filed after the ‘IP Translator’ judgment:** OHIM interprets all goods and services covered by the national marks on the basis of their natural and usual meaning (see Table 5 of the Common Communication).

In order to determine the scope of protection the abovementioned principles have to be applied. Only those goods or services deemed to be covered following these principles will be considered when making the comparison between the goods/services.

3 Similarity of Goods and Services

3.1 General principles

3.1.1 Similarity factors

Generally speaking, two items are defined as being similar when they have some characteristics in common. The similarity of goods and services does not depend on any specific number of criteria that could be determined in advance and applied in all cases.

The similarity of goods and services has been addressed in the case-law of the Court of Justice in Canon (judgment of 29/09/1998, C-39/97, Canon, EU:C:1998:442). The Court of Justice held that in assessing the similarity of goods *all* the relevant factors relating to those goods themselves should be taken into account. Those factors include, *inter alia*, their nature, their end users [*should read ‘intended purpose’*], their method of use and whether they are in competition with each other or are complementary (para. 23).

The term ‘*inter alia*’ shows that the enumeration of the above factors by the Court is only indicative. There may be other factors in addition to or instead of those mentioned by the Court that may be pertinent for the particular case.

This leads to the conclusion that the following factors should be taken into account:

Canon factors

- nature
- intended purpose
- method of use
- complementarity
- in competition.

Additional factors

- distribution channels
- relevant public
- the usual origin of the goods/services.

These factors will be further explained below (see ‘The specific similarity factors’); they are also used in the Office’s database on the comparison of goods and services. It should be noted, however, that even though the database is restricted to these eight factors, there might be specific cases where other criteria are relevant.

3.1.2 Defining relevant factors

The comparison should focus on identifying the relevant factors that specifically characterise the goods/services that are to be compared. Therefore, the relevance of a particular factor depends on the respective goods/services to be compared.

Example

- When comparing *skis* and *ski-boots* it is evident that they do not coincide in their nature or method of use and they are not in competition. Therefore, the comparison should focus on their purpose, their complementary character, their distribution channels, their usual origin and/or the relevant public.

Therefore, the relevant factors and features characterising a product or a service may be different depending on the goods and services they have to be compared with.

It is not necessary to list all possible factors. What does matter, however, is whether the connections between the relevant factors are sufficiently close to find similarity.

The following questions could be asked:

- How will the goods/services be used?
- What is their purpose?
- How likely is it that they coincide in producer?
- Are they usually found in the same outlet, department store or in the same section of a supermarket?

If the factors cannot already be defined from the wording of the goods/services, information may be derived from dictionary entries. However, dictionary entries have to be analysed against commercial realities and in particular taking into account the Nice Classification.

Example

- According to the dictionary, *ice* is the singular of *ices* and means *inter alia* ‘(an) ice cream’ or ‘water ice’ (*The Oxford English Dictionary, online edition*). If the comparison of *ices* and *ice* in Class 30 was done on the basis of the definition from the dictionary alone, it would lead to an erroneous conclusion that *ice* is identical to *ices*. However, since both *ices* and *ice* are mentioned in the list of goods in Class 30, *ices* are to be understood as ‘edible ices’, whereas *ice* is to be understood as ‘cooling ice’. Although they coincide in the composition to the extent that both consist (partly) of frozen water, their commercial nature is

different: while one is a foodstuff the other is an auxiliary good for preserving and/or cooling foodstuffs. It shows that the Nice Classification together with the commercial perspective prevail over the dictionary definition.

Once the relevant factors have been identified, the examiner must determine the relation between and the weight attributed to the relevant factors (see 'Relation between different factors' below).

3.2 The specific similarity factors

The following paragraphs define and illustrate the various factors for similarity of goods and services.

3.2.1 Nature

Nature of a product/service can be defined as the essential qualities or characteristics by which this product/service is recognised. Nature often corresponds to a particular type or sort of product/service or a specific category to which this product/service belongs and which is usually used to define it. In other words, it is the answer to the question 'What is it?'

Examples

- *Yoghurt* is a milk product;
- *Car* is a vehicle;
- *Body lotion* is a cosmetic.

3.2.1.1 Indicative value of class headings and categories

The fact that the goods/services to be compared fall under the same general indication of a class heading or broad category does not automatically mean that they have the same nature. An example of such a broad category is *foodstuffs for human consumption*.

Examples

- *Fresh fruit* (Class 31) on the one hand and *coffee, flour, and bread* (Class 30) on the other hand have a different nature despite being foodstuffs.
- *Meat, fish, poultry and game* (Class 29) are foodstuffs of animal origin. *Fruits and vegetables* (Class 31) are foodstuffs of plant origin. This slight connection, namely all being foodstuffs, does not preclude that their nature is different.

The fact that the goods/services to be compared fall under a sufficiently narrow general indication of a class heading favours an identical or similar nature.

Example

- *Condensed milk* and *cheese* (both in Class 29) share the same nature because they belong to the same product category, namely milk products, which are a

sub-category of foodstuffs (judgment of 4/11/2003, T-85/02, Castillo, EU:T:2003:288, § 33).

3.2.1.2 Features of the goods defining their nature

A variety of features of the goods in question may be useful for defining their nature. These include the following:

Composition: e.g. ingredients, materials of which the goods are made.

Example

- *Yoghurt* (Class 29) is a milk product (the nature of yoghurt may be defined by its basic ingredient).

Composition may be the most relevant criterion for defining nature. However, an identical or similar composition of the goods is not *per se* an indicator of the same nature.

Example

- A *chair* (Class 20) and a *doll* (Class 28) can both be made of plastic, but they do not have the same nature since one is a piece of furniture and the other is a toy. They belong to different categories.

Functioning principle: e.g. mechanical functioning, with or without engine/motor, optical, electrical, biological, or chemical functioning.

Example

- *Telescope* (Class 9) is an optical device (the nature of a telescope may be defined by its functioning principle, which is optical).

Although the functioning principle may help to define the nature of some goods, it is not always conclusive. There are cases where goods, in particular technology-related ones, with the same functioning principle have a different nature.

Example

- A *blender* and an *electric toothbrush* have the same functioning principle of rotation, but they do not have the same nature.

By contrast, there are goods with different functioning principles but the same nature.

Example

- The functioning principle of *washing machines using washing powder* is chemical, which is not the same as the functioning principle of *washing machines using magnetic waves*. However, these goods have the same nature as they are both washing machines.

Physical condition: e.g. liquid/solid, hard/soft, flexible/rigid

The physical condition is another feature of the goods that may be used to define nature but, like the functioning principle, it is not conclusive.

Examples

- All drinks are liquid. Their nature is different from the nature of solid foodstuffs. However, when comparing two different drinks, their physical condition should not be conclusive: *milk* (Class 29) does not have the same nature as an *alcoholic beverage* (Class 33).
- *Yoghurt* is marketed both in solid and liquid form. However, the nature of this good is not defined by its physical condition, but – as mentioned above – by its basic ingredient (milk). In both cases, the nature of a solid yogurt and of a liquid yogurt is the same (a milk product).

3.2.1.3 Nature of services

When defining the nature of services, the features (composition, functioning principle, physical condition) cannot be used since services are intangible.

The nature of services can be defined, in particular, by the kind of activity provided to third parties. In most cases, it is the category under which the service falls that defines its nature.

Example

- *Taxi services* (Class 39) have the same nature as *bus services* (Class 39) as they are both transport services.

3.2.1.4 Nature of goods versus nature of services

By their *nature*, goods are generally dissimilar to services. This is because goods are articles of trade, wares or merchandise. Their sale usually entails the transfer in title of something physical. Services, on the other hand, consist of the provision of intangible activities.

3.2.2 Intended purpose

Purpose is generally defined as the reason for which something is done or created or for which something exists (*Oxford Dictionary Online*).

As a Canon factor, purpose means the intended use of the goods or services and not any other possible use.

Example

- A *plastic bag* can be used as protection against the rain. However, its intended purpose is to carry items.

The purpose is defined by the function of the goods/services. In other words, it answers the questions: What need do these goods/services satisfy? What problem do they solve?

It is sometimes difficult to determine the proper level of abstraction for determining the purpose. As in the case of defining the nature, the purpose must be defined in a sufficiently narrow way.

Example

- In the case of *vinegar*, the intended purpose should not be defined as ‘human consumption’, which is the general purpose that all foodstuffs share, but as ‘everyday seasoning’.

3.2.3 Method of use

The method of use determines the way in which the goods/services are used to achieve their purpose.

The question to be asked is: How are these goods/services used?

Method of use often follows directly from the nature and/or intended purpose of the goods/services and therefore has no or little significance of its own in the similarity analysis.

Example

- The method of use of newspapers and books is the same in the sense that they are both read. However, similarity can already be concluded from the facts that they are both printed matter (same nature) and that they both serve to entertain or to inform (same purpose).

Notwithstanding the explanation above, the method of use may be important, independent of nature and purpose, where it characterises the goods:

Example

- *Pharmaceutical preparations for treating skin diseases* in Class 5 can take the form of creams. They have the same method of use as *cosmetic creams* in Class 3.

However, even where the method of use characterises the goods under comparison and where it is identical for both goods, this fact alone will not be sufficient to establish similarity.

Example

- *Chewing gum* (Class 30) and *chewing tobacco* (Class 34) have an identical method of use. However, this fact alone does not render them similar.

3.2.4 Complementarity

Goods (or services) are complementary if there is a close connection between them, in the sense that one is indispensable (essential) or important (significant) for the use of the other in such a way that consumers may think that responsibility for the production of those goods or provision of those services lies with the same undertaking (see, to that effect, judgments of 11/05/2011, T-74/10, Flaco, EU:T:2011:207, § 40; 21/11/2012, T-558/11, Artis, EU:T:2012:615, § 25; 04/02/2013, T-504/11, Dignitude, EU:T:2013:57, § 44).

The complementary relation between the goods/services can be, for example, functional.

Example

- *Internet site hosting services* in Class 42 cannot exist without *computer programming services* in Class 42. There is a functional complementarity between those services, which, by their nature, belong to the field of information technology. Moreover, these services are aimed at the same public and use the same distribution channels. They are therefore similar (judgment of 29/09/2011, T-150/10, Loopia, EU:T:2011:552, § 36 and 43).

By definition, goods intended for different publics cannot be complementary (judgments of 22/06/2011, T-76/09, Farma Mundi Farmaceuticos Mundi, EU:T:2011:298, § 30; 12/07/2012, T-361/11, Dolphin, EU:T:2012:377, § 48). See also paragraph 3.3.1, Interrelation between factors.

Example

- *Textile products* in Class 24 (aimed at the public at large) and *treatment services relating to textile products* in Class 40 (aimed at professionals) cannot be complementary (judgment of 16/05/2013, T-80/11, Ridge Wood, EU:T:2013:251, § 28-32). These goods and services are not similar.

Complementarity is not conclusive on its own for finding a similarity between goods and/or services. Although a degree of complementarity may exist, goods and/or services may be dissimilar.

Example

- There is a degree of complementarity between *wine* (Class 33) and *wineglasses* (Class 21) insofar as wineglasses are intended to be used for drinking wine. However, that complementarity is not sufficiently pronounced to conclude that these goods are similar. Furthermore, these goods do not have the same nature or usual origin nor do they usually share distribution channels (judgment of 12/07/2007, T-105/05, Waterford Stellenbosch, EU:T:2007:170, § 34, confirmed by judgment of 07/05/2009, C-398/07 P, Waterford Stellenbosch, EU:C:2009:288, § 45).

However, when the complementarity between goods/services has been identified in combination with other factors, such as 'usual origin' and/or 'distribution channel', similarity may be found:

Examples

- *Skis* (Class 28) and *ski boots* (Class 25) are complementary because the use of one is indispensable for the use of the other. The relevant public may think that the production of these goods lies with the same undertaking. In addition, they share the same public and distribution channels. These goods are consequently considered similar.
- *Teaching material* in Class 16 (such as, printed matter, pre-recorded data carriers and audio/video cassettes) is essential and thus complementary to *educational courses* in Class 41. Generally the material is issued by the same undertaking; they share the same public and distribution channels. These goods are similar to the services in question (see for example judgment of 23/10/2002, T-388/00, ELS, EU:T:2002:260).
- *Services of an architect (designing of buildings)* (Class 42) are indispensable for *building construction* (Class 37). These services are often offered together through the same distribution channels, by the same providers and to the same public. Consequently, these services are complementary and similar (judgment of 09/04/2014, T-144/12, Comsa, EU:T:2014:197, § 65-67).

3.2.4.1 Use in combination: not complementary

Complementarity has to be clearly distinguished from use in combination where goods/services are merely used together whether by choice or convenience (e.g. bread and butter). This means that they are not essential for each other (decision of 16/12/2013, R 0634/2013-4, ST LAB, § 20). In such cases similarity can only be found on the basis of other factors, but not on complementarity.

Example

- Even if the functioning of *transmission belts* in Class 12 can be measured with the help of a *device for motor-vehicle testing* in Class 9, this does not mean that the goods are complementary. It can be convenient in certain cases to measure the performance of one or the other parameter but simple convenience is not sufficient to conclude that one product is indispensable for the other (decision of 03/10/2013, R 1011/2012-4, SUN, § 39).

Certain goods that are often coordinated with each other but do not fall within the scope of other similarity factors, were determined by the Court to have 'aesthetic complementarity' (judgments of 01/03/2005, T-169/03, Sissi Rossi, EU:T:2005:72, § 62; 11/07/2007, T-150/04, Tosca Blu, EU:T:2007:214, § 35-39; 11/07/2007, T-443/05, Pirañam, EU:T:2007:219, § 49-50; 20/10/2011, T-214/09, Cor II, EU:T:2011:612, § 32-37). This relationship between the goods falls outside the existing definition of complementarity.

Example

- *Handbags* (Class 18) and *clothing* (Class 25) are closely connected but not complementary, since one is not essential for the use of the other. They are merely often used in combination. They are, however, similar because of the fact that they may well be distributed by the same or linked manufacturers, bought by the same public and can be found in the same sales outlets.

3.2.4.2 Ancillary goods/services: not complementary

When certain goods and/or services only support or supplement another product or service, they are not considered to be complementary within the meaning of the case-law. Ancillary goods are typically those used for packaging (e.g. bottles, boxes, cans, etc.) or for promotion (e.g. leaflets, posters, price lists, etc.). Equally, goods/services offered for free in the course of a merchandising campaign are usually not similar to the primary product or service.

Examples

- *Organisation and conducting of exhibitions* is not similar to *printed matter, including event notes* (Class 16), since these goods merely serve to promote and announce the specific event. These goods and services are not complementary.
- *Herbal nutritional supplements* in Class 5 are not indispensable or important for the use of *beers, mineral and aerated waters and other non-alcoholic drinks, fruit drinks and fruit juices, syrups and other preparations for making beverages* in Class 32. Any combined consumption of those products is merely ancillary. Therefore, these goods are not complementary. Furthermore, since their purpose, distribution channels and usual producers are different, and they are not in competition, these goods are not similar (judgment of 23/01/2014, T-221/12, Sun fresh, EU:T:2014:25, § 84).

3.2.4.3 Raw materials, parts, components and fittings: not complementary

Lastly, where the goods concern raw materials the criterion complementarity is not applicable in the analysis of similarity.

Raw materials as a significantly important basic component of an end product may be found similar to that product, but not on the basis of complementarity. Similar considerations apply to parts, components and fittings (see also Annex I, paragraphs 1 and 2, and Annex II, paragraphs 5.1 and 5.2).

Example

- *Plastic or synthetic products used as raw or semi finished material* (in Classes 1 and 17) cannot be regarded as complementary to *finished products* (made from these materials in Classes 9 and 12) on the ground that the raw materials are intended to be turned into the finished products (see, to that effect, judgment of 09/04/2014, T 288/12, Zytel, EU:T:2014:196, § 39).

3.2.5 In competition

Goods/services are in competition with each other when one can substitute the other. That means that they serve the same or similar purpose and are offered to the same actual and potential customers. In such a case, the goods/services are also defined as 'interchangeable' (judgment of 04/02/2013, T-504/11, DIGNITUDE, EU:T:2013:57, § 42).

Examples

- *Wallpaper* (Class 27) and *paints* (Class 2) are in competition because both cover or decorate walls.
- *Rental of movies* (Class 41) and *services of a cinema* (Class 41) are in competition because they both allow you to watch a movie.
- *Electric shavers* and *razor blades* (both in Class 8) are in competition because they serve the same purpose.

In some cases the price of goods/services in competition may differ significantly, but this fact alone does not affect the analysis of whether they are in competition with each other or not.

Example

- *Jewellery made of gold* and *fashion jewellery*⁷ (both in Class 14) are in competition even though their price (and value) may greatly differ.

3.2.6 Distribution channel

Although 'distribution channel' is not explicitly mentioned in the Canon judgment, it is widely used internationally and nationally in the assessment of whether two goods/services are similar. As an additional factor it has been taken into account in several judgments of the European Courts (see amongst others judgment of 21/04/2005, T-164/03, monBeBé, EU:T:2005:140, § 53). The reasoning for this is as follows.

If the goods/services are made available through the same distribution channels, the consumer may be more likely to assume that the goods or services are in the same market sector and are possibly manufactured by the same entity and vice versa.

The term 'distribution channel' does not refer so much to the way of selling or promoting a company's product but rather to the place of distribution. For the analysis of the similarity of goods/services, the distribution system – whether direct or indirect – is not decisive. The question to be asked is rather:

Do the goods/services have the same points of sale, or are they usually provided or offered at the same or similar places?

⁷ Fashion/costume jewellery is understood to be jewellery made from inexpensive metals and imitation gems or semiprecious stones, worn for decorative purposes.

However, not too much emphasis should be placed on this factor as modern supermarkets, drugstores and department stores sell goods of all kinds. The relevant public is aware that the goods sold in these places come from a multitude of independent undertakings. Therefore, the point of sale is less decisive when deciding whether the relevant public considers that goods share a common origin merely because they are sold at the same outlet.

Only where the goods in question are offered in the same *section* of such shops, where homogeneous goods are sold together, will this favour similarity. In such cases it must be possible to identify the section by its territorial and functional separation from other sections (e.g. dairy section of a supermarket, the cosmetic section of a department store).

Similarly, the factor may be valid in cases in which goods are sold exclusively or commonly in specialised shops. In that event, consumers may tend to believe the origin of the goods to be the same if they are both sold in the same specialised shops and may tend to deny that mutual origin if they are not usually sold in the same shops.

Conversely, different sales outlets may weigh against the similarity of goods.

Example

- *Wheelchairs versus bicycles:*

Although both fall under *vehicles* in *Class 12*, they will not be found at the same sales points. Bicycles are usually sold either in specialist bicycle stores or in a retail store where sporting equipment is available. In contrast, the distribution channels of *wheelchairs* are specialised distributors of medical equipment and devices supplying hospitals and specialised shops where devices for disabled or physically handicapped people are sold.

3.2.7 Relevant public

The relevant public, i.e. the actual and potential customers of the goods and services in dispute, constitutes another factor to be dealt with in the analysis of their similarity (see the Guidelines, Part C, Opposition, Section 2, Identity and Likelihood of Confusion, Chapter 6, Relevant Public and Degree of Attention).

The relevant public can be composed of:

- the general public (public at large) or
- professional public (business customers or specialised public).

The relevant public does not necessarily mean the end user, e.g. the end users of food for animals in *Class 31* are animals, not the relevant public. The relevant public in this case would be the general consumer.

The mere fact that the potential customers coincide does not automatically constitute an indication of similarity. The same group of customers may be in need of goods or services of the most divergent origin and nature. The fact that, for example, television sets, cars and books are bought by the same relevant public, namely the public at large, has no impact on the similarity analysis. In many cases, either one or both lists of goods/services under comparison target the public at large, but the purpose

(customers' needs covered) in each case is different. Such circumstances weigh against similarity.

While a coincidence in the relevant public is not necessarily an indication of similarity, largely diverging publics weigh heavily against similarity.

Diverging customers can be found in the following cases where:

- (a) the goods/services of both lists are directed at the public at large, which can however be clearly categorised by their different (personal) needs, ages, etc.
 - Example: *wheelchairs* versus *bicycles* (Class 12).
- (b) the goods/services of both lists target business customers, however acting in a very different market sector.
 - Example: *chemicals used in forestry* versus *solvents for the lacquer industry* (Class 1).
- (c) one relevant public consists of general consumers and the other of business customers.
 - Example: *containers for contact lenses* (in Class 9) versus *surgical apparatus and instruments* (in Class 10).

3.2.8 Usual origin (producer/provider)

Although the Court of Justice did not explicitly mention this factor in its Canon judgment, it follows from the general concept of likelihood of confusion that the usual origin of the goods and services is of particular importance for the analysis of similarity. As the Court has stated, it is 'the risk that the public might believe that the goods or services in question come from the same undertaking or, as the case may be, from economically linked undertakings, [that] constitutes a likelihood of confusion' (*Canon*, para. 29). Hence, there is a strong indication of similarity when, in the mind of the relevant public, the goods/services have the same usual origin.

However, this should not be misinterpreted as turning the examination of likelihood of confusion and similarity of goods/services upside down: the finding of a likelihood of confusion depends on many other factors (such as the similarity of signs, the distinctiveness of the earlier mark) and is not exclusively determined by the usual origin, which as such is only one factor in the analysis of the similarity of goods/services.

A finding that consumers will not be confused about the origin of the goods/services is not an argument appropriate to the comparison of goods/services. This finding should be mentioned in the overall assessment of likelihood of confusion. Origin, in this context, relates mainly to the manufacturing sector (industry) or kind of undertaking producing the goods or offering the services in question rather than to the identity of the producer.

The 'origin' is not merely defined by the actual place of production/provision (e.g. factory, workshop, institute or laboratory) but primarily by taking into consideration who manages and/or controls the production/provision of the goods/services. In other

words, the question to be asked is: who is responsible for manufacturing the product or providing the service?

The geographical origin (e.g. China) is not relevant for the finding of similarity of goods/services.

In the ELS judgment the Court held that even goods and services can have the same origin if it is common that the same type of company is responsible for the production/provision of both. *Educational textbooks* (Class 16) were considered to have the same origin as *provision of correspondence courses* (Class 41) since ‘undertakings offering any kind of course often hand out those products to pupils as support learning materials’ (judgment of 23/10/2002, T-388/00, ELS, EU:T:2002:260, § 55).

The criterion ‘usual origin’ has to be applied in a restrictive way in order not to dilute it. If all kinds of goods/services deriving from one big (multinational) company or holding were found to have the same origin, this factor would lose its significance.

Example

- *Cosmetics* (Class 3) and *foodstuffs* (Classes 29 to 31) might be produced under the umbrella of one company but this does not reflect common trade custom, according to which these types of goods have different producers, each belonging to a specific industry.

3.2.8.1 Features defining a common origin

When determining the usual origin of a product/service the following features might be relevant.

Manufacturing sites

Example

- *Varnishes, lacquers colorants and mordants* (Class 2) are typically produced in the same production enterprises, normally by specialised chemical companies.

The place of production can be a strong indicator that the goods/services in question come from the same source. However, while the same manufacturing sites suggest a common usual origin, different manufacturing sites do not exclude that the goods come from the same or economically linked undertakings. For instance, *books* (Class 16) and *electronic media* (Class 9) (goods in competition, e-media substituting books) are both goods of a publishing house.

Methods of manufacture

Example

- *Leather belts* (Class 25) and *leather handbags* (Class 18) are not only manufactured in the same sites, e.g. leather workshops, but also use the same tools and machines for the treatment of leather.

(Technical) know-how

Example

- *Computer virus protection services* (Class 42) and *software design* (Class 42) involve similar technical know-how in the field of information technology.

Established trade custom known to the public

An established trade custom, such as when manufacturers expand their businesses to adjacent markets, is of particular importance for concluding that goods/services of different nature have the same origin. In such situations it is necessary to determine whether such expansion is common in the industry or, conversely, whether it may occur in exceptional cases only.

Example where extension has become customary

- *Shoes* (Class 25) and *handbags* (Class 18): It is customary on the market that the producers of shoes are also involved in the manufacture of handbags.

Example where extension is not (yet) common

- *Clothing* (Class 25) and *perfumes* (Class 3): Even though some couturiers that make fashion clothes nowadays also sell perfumes under their marks, this is not the rule in the clothing industry, and rather applies to (economically) successful designers.

3.3 Relation between different factors

The Canon criteria were enumerated in the relative judgment without any hierarchy (weight) between them and without indicating any relation between them. They were considered one by one. However, they cannot be considered independently since some criteria are interrelated and some criteria are more important than others, regardless of whether goods are being compared with goods, services with services or goods with services. As a result of weighing all these factors in accordance with their respective importance in relation to the goods/services at issue, similarity may be found to various degrees: low, average or high (see paragraph 3.3.4 below).

3.3.1 Interrelation of factors

In many cases there will be relationships between the factors in the sense that where one is shared another one might coincide as well.

Examples

- Based on the purpose, it is also possible to determine who the actual and potential customers (i.e. the relevant public) are.
- The purpose, together with the relevant public, may also reveal whether goods/services are in competition.

- The same distribution channel goes hand in hand with the same public. In other words, where the distribution channels are different, the public may be different as well.
- Goods/services intended for different publics cannot be complementary (judgments of 11/05/2011, T-74/10, Flaco, EU:T:2011:207, § 40, 22/06/2011; T-76/09, Farma Mundi Farmaceuticos Mundi, EU:T:2011:298, § 30).
- The method of use usually depends on the nature and purpose of the goods.

There are cases in which a distinction between various factors will be difficult to draw. This is particularly true as far as 'nature', 'purpose' and 'method of use' are concerned. Where the examiner encounters such difficulties, it is sufficient to treat these factors jointly.

Example

- An *engine* is a machine for converting any of various forms of energy into mechanical force and motion. In such a case, it is difficult to distinguish the nature from the purpose of the product. Therefore, a distinction between what – in this case – is nature and what is purpose is not necessary.

3.3.2 Importance of each factor

In assessing the similarity of goods and services **all** relevant factors characterising the relationship between them should be taken into account. However, depending on the kind of goods and services a particular criterion may be more or less important. In other words, the various criteria do not have a standard value, but rather their specific importance should be determined in the context of each individual case.

In general, the weight of each factor will depend on the impact it has on a possible confusion of the origin. Criteria clearly suggesting that the goods/services come or do not come from the same undertaking or economically linked undertakings should take precedence.

Generally strong factors

- Usual origin (because it has a strong impact on likelihood of confusion which relates to common commercial origin).
- Purpose (because it is decisive for the choice of the customer buying or selecting goods/services).
- Nature (because it defines the essential qualities and characteristics of the goods/services).
- Complementarity (because the close connection between the use of the goods/services makes the public believe that they share the same source).
- In competition (usually goods/services that are in competition have the same purpose and target the same public).

Less important factors

- Method of use (even dissimilar goods can be used in the same manner, e.g. *baby carriages* and *shopping trolleys*).
- Distribution channels (even dissimilar goods can be sold in the same section of stores depending on different display practices, e.g. *chewing gum* (Class 30) and *cigarettes* (Class 34)).
- Relevant public (especially when goods/services target the general public).

3.3.3 Different types of comparisons: goods versus goods, services versus services and goods versus services

In principle, the same factors for comparing goods with goods are relevant for the comparison of services with services. However, in applying these factors, the basic difference between goods and services (tangible v intangible) must be considered.

Furthermore, the same principles that apply for the comparison between goods and goods and between services and services apply in cases where goods are compared with services.

By their nature goods are generally dissimilar to services. They can, however, be complementary. Services can also have the same purpose and thus be in competition with goods. It follows that under certain circumstances similarity between goods and services can be found.

3.3.4 Degree of similarity

Goods and/or services can be found similar to different degrees (low, average, high) depending on how many factors they share and the weight given to each of them. The degree of similarity found between the goods and services is of relevance when finally deciding on the likelihood of confusion.

Generally, one factor on its own is not sufficient to find a low degree of similarity between the goods/services, even if it is a strong factor.

Examples of dissimilarity

- *Cars* and *bicycles* (both in Class 12) share the same purpose (taking oneself from A to B), but this does not render them similar.
- Although *window glass* (Class 19) and *glasses for spectacles* (Class 9) have the same nature, they are not similar, since they do not coincide in other relevant factors, such as purpose, producers, distribution channels and relevant public.

It is the combination of various factors and their weight that allows the final conclusion on similarity. The combination of two strong factors, such as nature and producer, or the combination of one strong and two weak factors will often lead to similarity. In

contrast, the combination of two weak factors, such as distribution channel and relevant public are, in principle, not conclusive for a finding of similarity between the goods and services.

Examples of similarity

- *Milk* and *cheese* (both in Class 29) have a different purpose and method of use; they are not in competition or complementary. However, the fact that they share the same nature (dairy goods) and usual origin (dairy company) is decisive for a finding of similarity.
- Although *pharmaceuticals* and *plasters* (both in Class 5) have a different nature, they share a similar purpose, i.e. the cure of diseases, disabilities or injuries. Furthermore, they have the same distribution channels and relevant public. Therefore, they are similar.

The amount of coinciding factors found together with their importance/weight establishes the degree of similarity. Generally speaking, the higher the number of common factors the higher the degree of similarity. A similarity found on the basis of only two factors would normally not be high, contrary to cases where the goods/services coincide in four or more relevant factors.

However, no mathematical analysis is possible since it always depends on the specific circumstances of each case.

Annex I

Specific Questions as to the Similarity of Goods and Services

This part does not establish new criteria for finding a similarity between goods and services. It merely helps to clarify how to compare specific groups of goods and services where, apart from the Canon criteria, some general rules and exceptions apply.

1 Parts, components and fittings

The mere fact that a certain product can be composed of several components does not establish automatic similarity between the finished product and its parts (judgment of 27/10/2005, T-336/03, Mobilix, EU:T:2005:379, § 61).

Examples of dissimilarity

- *Fan blades* (Class 7) and *hair dryer* (Class 11)
- *Electric cable* (Class 9) and *lamp* (Class 11)
- *Buttons* (Class 26) and *clothing* (Class 25)

Similarity will only be found in exceptional cases and requires that at least some of the main factors for a finding of similarity, such as producer, public and/or complementarity are fulfilled.

Such an exception is based on the fact that parts and fittings are often produced and/or sold by the same undertaking that manufactures the end product and target the same purchasing public, as in the case of spare or replacement parts. Depending on the product concerned, the public may also expect the component to be produced by, or under the control of, the 'original' manufacturer, which is a factor that suggests that the goods are similar.

In general, a variety of factors may be significant in each particular case. For instance, if the component is also sold independently, or if it is particularly important for the functioning of the machine, this will favour similarity.

Examples of similarity

- *Electric toothbrush* (Class 21) and *replacement brush heads* (Class 21)
- *Printer* (Class 9) and *ink jet cartridges* (Class 2)
- *Sewing machines* (Class 7) and *walking feet for sewing machines* (Class 7)

2 Raw material and semi-processed goods

A similar approach is also followed in relation to raw materials and semi-processed goods on the one hand and finished goods on the other.

In most cases, the mere fact that one product is used for the manufacture of another will not be sufficient in itself to show that the goods are similar, as their nature, purpose, relevant public and distribution channels may be quite distinct (judgment of

13/04/2011, T-98/09, T Tumesa Tubos del Mediterráneo S.A., EU:T:2011:167, § 49-51). According to case-law, the raw materials subject to a transformation process are essentially different from the finished products that incorporate, or are covered by, those raw materials, in terms of nature, aim and intended purpose (see, to that effect, judgment of 03/05/2012 in Case T-270/10, Conceria Kara v OHIM — Dima (KARRA), not published in the ECR, paragraph 53). Furthermore, they are not complementary since one is manufactured with the other, and raw material is in general intended for use in industry rather than for direct purchase by the final consumer (judgment of 09/04/2014, T-288/12, Zytel, EU:T:2014:196, § 39-43).

Examples of dissimilarity

- *Leather, animal skins* (Class 18) and *clothing* (Class 25)
- *Precious metals* (Class 14) and *jewellery* (Class 14)

However, the final conclusion may depend on the specific circumstances of the case, such as the degree of transformation of the raw material or whether it is the basic component of the end product. The greater the significance of the raw material for the end product, the more likely the goods will be similar. Consequently, similarity might be established when the raw material or the semi-finished product can be decisive for the form, character, quality or value of the end product. In these cases, the raw material can often be obtained separately from the end product through the same distribution channels.

Example of similarity

- *Precious stones* (Class 14) and *jewellery* (Class 14). Contrary to *precious metals*, *precious stones* can be obtained in jewellery shops independently of the end product.

A sub-category of raw materials is *ingredients used for the preparation of foodstuffs* (see '*Ingredients*' below).

3 Accessories

An accessory is something extra that improves or completes the main product it is added to. Unlike parts, components and fittings an accessory does not constitute an integral part of the main product, although it is usually used in close connection. An accessory usually fulfils a useful technical or decorative purpose.

The rules in respect of parts, components and fittings are to a certain extent also valid in the case of accessories. The mere fact that a certain product is used in combination with another is not necessarily conclusive for a finding of similarity.

Examples of dissimilarity

- *Clothing* (Class 25) and *hair ornaments* (Class 26)
- *Car sun blinds* (Class 12) and *vehicles* (Class 12)

However, it is common that some accessories are also produced by the manufacturer of the main product. Consequently the consumer may expect that the main product and the accessories are produced under the control of the same entity, especially when

they are distributed through the same channels of trade. In such cases there is a strong indication for similarity.

Examples of similarity

- *Bicycles* (Class 12) and *panniers for bicycles* (Class 12)
- *Glasses* (Class 9) and *cases for glasses* (Class 9)

4 Installation, maintenance and repair services

These services belong to the category of goods-related services.

Since by nature goods and services are dissimilar, a similarity between goods and their installation, maintenance and repair can only be established when:

- it is common in the relevant market sector for the manufacturer of the goods to also provide such services; and
- the relevant public coincides; and
- installation, maintenance and repair of these goods are provided independently of the purchase of the goods (not aftersales services).

The installation of virtually all goods is classified in Class 37, such as *installation of air conditioning apparatus, electric appliances, elevators or lifts, fire alarms, freezing equipment, kitchen equipment, and machinery*. The *installation and repair of computer hardware* is also in Class 37 as it is a physical repair and installation activity. However, *installation and repair of computer software* is classified in Class 42 because it involves computer programming without any physical installation or repair.

Examples of similarity

- *Data processing equipment and computers* (Class 9) and *installation and repair of electronic apparatus* (Class 37)
- *Air conditioning apparatus* (Class 11) and *installation, maintenance and repair services* (Class 37)
- *Vending machines* (Class 7) and *maintenance services* (Class 37)

Examples of dissimilarity

- *Building materials* (Class 19) and *installation services* (Class 37)
- *Shoes* (Class 25) and *repair of shoes* (Class 37)
- *Vehicles* (Class 12) and *dent removal for motor vehicles* (Class 37) (judgment of 15/12/2010, T-451/09, Wind, EU:T:2010:522, § 28-30)

5 Advisory services

Advisory services refers to providing advice that is tailored to the circumstances or needs of a particular user and that recommends specific courses of action for the user. *Provision of information*, on the other hand, refers to providing a user with material (general or specific) about a matter or service but not advising the user on specific courses of action.

With the 8th edition of the Nice Classification, '*professional consultation services*' in Class 42 were eliminated. Since then consultation services – as well as *advisory and information services* – are classified in the class of the service that corresponds to the subject matter of the consultation. For instance, *transportation consultancy* belongs to Class 39, *business management consultancy* falls under Class 35, *financial consultancy* is classified in Class 36 and *beauty consultancy* in Class 44. The rendering of the advice, information or consultancy by electronic means (e.g. telephone, computer) does not affect the classification of these services.

Advisory, consultancy and information services are in principle always similar, or even identical, to the services to which they relate.

Examples

- *Financial information services* (Class 36) are included in *financial affairs* (Class 36) and thus identical (judgment of 27/02/2008, T-325/04, Worldlink, EU:T:2008:51, § 58).
- *Computer software advisory* (Class 42) is similar to the *installation and maintenance of software* (Class 42) because although they may not necessarily be included in *installation and maintenance of software* they are often complementary.
- When it comes to the comparison of advisory, consultancy and information services with goods, similarity can be found under conditions akin to those concerning maintenance, installation and repair (see paragraph 4 above).

Examples of similarity

- *Advisory services in computer technologies (hard-and software)* (Class 42) and *computer software* (Class 9)
- *Beauty consultancy* (Class 44) and *cosmetics* (Class 3)

Examples of dissimilarity

- *Information services concerning the purchase of fashion articles (shoppers guide information)* (Class 35) and *clothing, footwear and headgear* (Class 25), as it is not common in the market for the manufacturer of articles in Class 25 to provide such information services.
- *Providing information in the field of entertainment* (Class 41) and *toys* (Class 28), as it is not common in the market for the manufacturer of toys in Class 28 to provide such information services.

6 Rental and leasing

Rental services are classified in the same classes as the service provided by means of the rented objects:

- *rental of telephones* is Class 38 because *telecommunication services* are in Class 38;

- *rental of cars* is in Class 39 because *transport services* are in this class.

Leasing services are analogous to rental services and therefore are classified in the same way. However, hire- or lease-purchase financing is classified in Class 36 as a financial service.

Based on the understanding that *leasing* in English means rental, these services must be clearly distinguished from any financial services. The comparison of rental and leasing services leads to the outcomes shown in the following paragraphs.

6.1 Rental/leasing versus related services

Even though rental services are classified in the same classes as the service provided by means of the rented objects, they are not automatically identical to this service. The comparison between these services has to be done applying normal criteria for identity and similarity.

Examples

- There is identity between *rental of flats* (Class 36) and *real estate affairs* (Class 36) because *rental of flats* is included in *real estate affairs*.
- The same reasoning cannot apply to *rental of bulldozers* (Class 37) and the related services of *building construction* (Class 37). *Rental of bulldozers* is not included in *building construction* and therefore these services are not considered to be identical.

6.2 Rental/leasing versus goods

Rental/leasing services are in principle always dissimilar to the goods rented/leased.

Examples

- *Vehicle rental* (Class 39) and *vehicles* (Class 12)
- *Rental of films* (Class 41) and *DVDs* (Class 9)

Exceptions exist where it is common for the manufacturer of the goods to also provide rental services.

- *Rental and leasing of computer software* (Class 42) and *computer software* (Class 9) are considered to be similar to a low degree.
- *Rental of automatic vending machines* (Class 35) and *automatic vending machines* (Class 7) are considered to be similar to a low degree.

Annex II

Specific Industries

1 Chemicals, pharmaceuticals and cosmetics

1.1 Chemicals (Class 1) versus chemical products (Classes 3 and 5)

Although major chemical companies are usually involved in the production of all kinds of basic chemicals, speciality chemicals and life science products, including pharmaceuticals and pesticides, as well as consumer products, such as cleaning preparations and cosmetics, the mere fact that their nature coincides – as all of them can be broadly classified as chemical products – is not sufficient to find them similar. Special attention must be drawn to the specific purpose of these chemicals as well as to their public and distribution channel. What has been said above as to the relation between raw materials, semi-processed and finished products particularly applies to these products.

Consequently, although goods in Class 3 and Class 5 are usually combinations of various chemicals, they are in principle not considered similar to goods included in Class 1. Their purpose as a finished product usually differs from goods in Class 1, which are mainly in their raw, unfinished state and not yet mixed with other chemicals and inert carriers into a final product. The finished products in Class 3 and Class 5 usually also target a different public and do not share the same distribution channels.

On the other hand, it cannot be excluded that goods such as *chemicals used in agriculture, horticulture and forestry* require few processing steps to be considered a finished product such as *fungicides*. Such chemicals may be considered to already share the inherent purpose of *fungicides*: to kill or inhibit fungi or fungal spores, in particular when they consist of the fungicide's active ingredient. Furthermore, the same (agro-)chemical companies may produce the semi-processed goods as well as the final product. There is therefore a low degree of similarity between *chemicals used in agriculture, horticulture and forestry* and *fungicides* (decision of 08/10/2012, R 1631/2012-1, QUALY/QUALIDATE, § 27-28).

Furthermore, there are also goods in Class 1 that are not mere chemicals but are semi-finished or even finished products with a specific purpose of use, which is an important factor that must be taken into account when comparing goods in Class 1 to goods in other classes.

For example *manures* in Class 1 on the one hand and *pesticides, fungicides and herbicides* in Class 5 on the other are not only chemical products but also finished products with a specific use in the agricultural industry. They therefore have a similar purpose as the specific goods in Class 5 can be considered growth-enhancing by preventing conditions that could inhibit plant growth. As such they are similar to a low degree.

1.2 Pharmaceuticals versus pharmaceuticals

A pharmaceutical preparation refers to any kind of medicine, that is to say, a substance or combination of substances for treating or preventing diseases in human beings or

animals. From its definition it can already be concluded that *veterinary preparations* – though separately mentioned in the class heading – are included in the broader term of *pharmaceutical preparations*. Therefore they are identical.

The same applies to herbal and homoeopathic medicines since they are comprised in the broad term of *pharmaceutical preparations*.

Equally, testing preparations, that is to say, chemical reagents for medical – including veterinary – purposes, also fall under the general indication of *pharmaceutical preparations*.

Specific pharmaceuticals are considered to be similar to other specific pharmaceuticals. This is because several, if not all, criteria for similarity are usually met: they share the same nature because they are specific chemical products; their purpose is, broadly speaking, healing and/or curing; they are sold in the same places, namely, pharmacies; and they come from the same source, which is the pharmaceutical industry. This industry manufactures a wide variety of drugs with various therapeutic indications, something the general public is aware of. Furthermore, their method of use can be the same and they can be in competition with one another (judgment of 17/11/2005, T-154/03, Alrex, EU:T:2005:401, § 48).

However, the degree of similarity found between specific pharmaceuticals may vary depending on their specific therapeutic indications.

Example 1

- *Sedatives versus pain killers*. These pharmaceuticals are highly similar.

Example 2

- *Anti-epileptics versus pharmaceutical preparations, except medicines to combat diseases in connection with the central nervous system*. These pharmaceutical preparations are considered to be similar (judgment of 24/05/2011, T-161/10, E-Plex, EU:T:2011:244, § 24-25).

Example 3

- *Contraceptives versus eye-washes*. These pharmaceutical preparations are only similar to a low degree. In this regard, it should be noted that a low degree of similarity should only be established in exceptional cases, e.g. when it can be clearly established that they have different therapeutic indications and different methods of use.

Whether a specific pharmaceutical is sold under prescription is not of particular relevance for the comparison of the goods. Therefore, a prescription medicine is generally to be considered similar to an over-the-counter drug for the reasons stated above. (For information on the relevant public and the degree of attention in relation to pharmaceuticals, see the Guidelines Part C. Section 2 Double Identity and Likelihood of Confusion, Chapter 3, Relevant Public and Degree of Attention).

1.3 Pharmaceuticals versus dietetic substances adapted for medical use

Dietetic substances and food supplements adapted for medical use are substances prepared for special dietary requirements with the purpose of treating or preventing a disease. Bearing this in mind, their purpose is similar to those of *pharmaceutical products* (substances used in the treatment of diseases) insofar as they are used to improve the patient's health. The relevant public coincides and these goods generally share the same distribution channel. For the above reasons, these goods are considered to be similar.

1.4 Pharmaceuticals versus cosmetics

The general categories *pharmaceuticals* and *cosmetics* are considered to be similar. Cosmetics include a list of preparations used to enhance or protect the appearance or odour of the human body. Pharmaceuticals on the other hand comprise products, such as skin or haircare preparations, with medical properties. They may coincide in purpose with cosmetics. Moreover, they share the same distribution channels since they can be found in pharmacies or other specialised shops. They target the same public and are often manufactured by the same companies.

However, when comparing specific pharmaceuticals with cosmetics they may only show a low degree of similarity or they may even be entirely dissimilar. In such cases this will depend on the specific drug and its specific purpose (medical indication/effect) or its method of use.

Example

- A *painkiller* is dissimilar to *nail polish*.

1.5 Pharmaceuticals versus services

Although pharmaceutical companies are heavily involved in research and development activities, they usually do not provide such services to third parties. Consequently, Class 5 goods are generally dissimilar to all services covered by Class 42.

Dissimilarity should also be found when comparing *pharmaceutical preparations* and *medical (including veterinary) services* in Class 44. Even though a certain link cannot be denied due to the common goal of treating diseases, the differences in nature and especially in the usual origin clearly outweigh any similarities. The relevant public does not expect a doctor to develop and market a drug.

2 Automobile industry

The automotive industry is a complex industry involving various kinds of companies, including car manufacturing companies as well as suppliers that might provide the car manufacturer with their raw materials (metal, aluminium, plastics, paints), parts, modules or complete systems. Several areas of production can be distinguished: drive engineering, chassis, electronic, interior and exterior.

The complexity of the industry and the fact that the final product incorporates some component parts and accessories complicates the examination of similarity between the end product (e.g. a car) and the various parts or materials used for its production. Furthermore, when purchasing a car, the general public knows that the car incorporates many items from many sources and that the car manufacturer might assemble components that have been manufactured by others. However, as far as the consumer of a car is concerned, the goods are normally offered under only one sign, which makes it almost impossible for the general public to identify other manufacturers or to differentiate their source of production. Exceptions include car batteries or tyres, where other signs are usually visible.

As with other industries, the Canon criteria apply accordingly and in particular the general principles set out for the comparison of parts, components, and fittings have to be taken into consideration.

In particular, it should be kept in mind that there are goods that will only be purchased by the automobile industry without any possibility of them ever reaching or being purchased by the general public (end consumer). An example is the common metal (Class 6) used to form the chassis. Such goods are clearly dissimilar to the car and probably dissimilar to all other parts, components and fittings. On the other hand, there are spare parts that might also be purchased by the general public for repair or maintenance purposes. Assessment of the similarity of these goods will mainly depend on whether the specific spare part is commonly produced by the car manufacturer.

3 Electric apparatus/instruments

The expression *electric apparatus and instruments* in Class 9 cannot be interpreted as covering all apparatus powered by electricity. Indeed, there are apparatus powered by electricity in various classes. The term *electric apparatus* included in the list of goods in Class 9 is to be understood as only covering apparatus and instruments for conducting, switching, transforming, accumulating, regulating or controlling electricity.

4 Fashion and textile industries

Goods classified in Classes 22, 23, 24 and 25 are textile-related. There is a certain progression through these classes: *raw fibrous textile materials*, i.e. fibres (Class 22), are further made into *yarns and threads* (Class 23), then into *textiles*, i.e. fabrics (Class 24), and end up as finished *goods made of textile* (Class 24) or *clothing* (Class 25).

Moreover, Class 18 goods such as *goods made of leather and imitations of leather* are also related to the fashion and textile industries.

4.1 Raw or semi-processed materials versus finished goods

Since the relationship between the abovementioned classes is often based on the fact that one product is used for the manufacture of another (e.g. *textiles* in Class 24 are used for the manufacture of *clothing* in Class 25), in comparisons of this kind, general rules concerning raw materials apply (see Annex I, paragraph 2, on 'Raw materials and semi-processed goods' above).

For example, raw materials such as *leather and imitations of leather, animal skins and hides* (Class 18) are dissimilar to clothing, footwear and headgear (Class 25). The mere fact that leather is used for the manufacture of footwear (shoes made of leather) is not sufficient in itself to conclude that the goods are similar, as their nature, purpose and relevant public are quite distinct: raw materials are intended for use in industry rather than for direct purchase by the final consumer.

However, a low degree of similarity is found between *textiles* and *textile goods* such as *bed sheets* and *table covers*, in Class 24. In such cases, the degree of transformation required from material to end product is often insignificant: the fabric is merely cut into shape and/or sewn to obtain the finished product. Furthermore, many establishments allow customers to purchase the base material or ready-made cushions, etc. made from such material. Therefore, the relevant public may expect these goods to come from the same undertakings.

4.2 Textile goods (Class 24) versus clothing (Class 25)

The main point of contact between *textile goods* in Class 24 and *clothing* in Class 25 is that they are made of textile material. However, this is not enough to justify a finding of similarity. They serve completely different purposes: *clothing* is meant to be worn by people, or serves as a fashion article, whereas *textile goods* are mainly for household purposes and interior decoration. Therefore, their method of use is different. Moreover, the distribution channels and sales outlets of *textile goods* and *clothing* are different and the relevant public will not think that they originate from the same undertaking. Therefore, *textile goods* are considered to be dissimilar to *clothing* see decisions of 31/05/2012, R 1699/2011-4 GO/GO GLORIA ORTIZ, § 16; 26/07/2012, R 1367/2011-1 PROMO TEXTILE/Promodoro, § 17; 01/08/2012, R 2353/2010-2, REGRIGUE FOR COLD/REFRIGIWEAR et al., § 26).

4.3 Clothing, footwear and headgear (Class 25)

Class 25 goods, namely *clothing, footwear and headgear* are of an identical or very similar nature. They serve the same purpose since they are used to cover and protect various parts of the human body against the elements. They are also articles of fashion and are often found in the same retail outlets. Consumers, when seeking to purchase clothes, will expect to find footwear and headgear in the same department or shop and vice versa. Moreover, many manufacturers and designers will design and produce all of the aforementioned items. Therefore, these goods are similar to each other.

4.4 Fashion accessories

As explained in the paragraph on ‘Accessories’ (see Annex I, paragraph 3 above), the mere fact that a certain product is used in combination with another is not necessarily conclusive for a finding of similarity. However, it is common for some accessories also to be produced by the manufacturer of the main product. Consequently, the consumer may expect that the main product and the accessories are produced under the control of the same entity, especially when they are distributed through the same trade channels. In such cases, there is a strong indication for similarity. Therefore, not all goods that are considered as fashion accessories will be found to be similar to *clothing, footwear and headgear* (Class 25).

The broad category of *goods made of leather and imitations of leather* in Class 18 includes goods such as (hand)bags, sports bags, briefcases, wallets, purses, key cases, etc. These goods are related to articles of *clothing, headgear and footwear* in Class 25, in the sense that they are likely to be considered by the consumers as aesthetic complementary accessories to articles of outer clothing, headgear and even footwear because they are closely co-ordinated with these articles and may well be distributed by the same or linked manufacturers, and it is not unusual for clothing manufacturers to directly produce and market them. Moreover, these goods can be found in the same retail outlets. Therefore, these goods are considered to be similar to *clothing, headgear and footwear*.

In contrast, hair accessories such as *hair pins* and *ribbons* are dissimilar to *clothing*. Even though these goods might have some distant link to the fashion market, the mere fact that someone might want to match hair pins and clothing is not sufficient to conclude that these goods are complementary and therefore similar. The goods can only be considered to be complementary if there is a close connection between them, in the sense that one is indispensable or important for the use of the other and is not merely ancillary. In the present case, these conditions are not fulfilled. Furthermore, the nature and method of use of these goods is different. They are not in competition with each other. The production of these goods involves different know-how, they do not belong to the same category of goods and they are not regarded as components of a general array of goods that potentially have the same commercial origin (decision of 03/10/2011, R 1501/2010-4, Wild Nature/WILD NATURE, § 18).

Likewise, luxury goods such as glasses (Class 9) and jewellery (Class 14) are considered to be dissimilar to clothing, footwear and headgear. The nature and the main purpose of these goods are different. The main function of clothing is to dress the human body whilst the main purpose of glasses is to improve eyesight, and jewels are worn for personal adornment. They do not have the same distribution channels and they are neither in competition nor complementary (decisions of 30/05/2011, R 0106/2007-4, OPSEVEN2 / SEVEN, § 14; 12/09/2008, R 0274/2008-1, Penalty / PENALTY, § 20; 05/10/2011, R 0227/2011-2, OCTOPUSSY / OCTOPUSSY ET AL, § 23-26).

The same reasoning applies to luxury goods such as perfumes (Class 3) – the main purpose of which is to impart a long-lasting scent to the body, stationery, etc. – and goods such as travelling bags (Class 18), which are intended to carry things when travelling. Even though couturiers nowadays also sell perfumes, fashion accessories (such as glasses and jewellery) and travel accessories under their marks, this is not the rule, and rather applies only to (economically) successful designers.

4.5 Sports clothing, footwear and headgear (Class 25) versus sporting and gymnastic articles (Class 28)

The general category of *clothing, footwear and headgear* includes sports clothing, footwear and headgear, which are garments or items of apparel designed specifically to be used when performing an activity or sport. Although the nature of these goods is different from those of *sporting and gymnastic articles*, which are articles and apparatus for all types of sports and gymnastics, such as weights, halters, tennis rackets, balls and fitness apparatus, there are undertakings that manufacture both *sporting and gymnastic articles* as well as *sports clothing/sports footwear*. Therefore,

the distribution channels can be the same. There is a low degree of similarity when *sports clothing/sports footwear* is compared to *sporting and gymnastic articles*.

4.6 Fashion design (Class 42) and tailoring services (Class 40) versus clothing (Class 25)

There is a low degree of similarity between *clothing* and *fashion design* and *tailoring* services since they share the same relevant public and might coincide in the same usual origin (producer/provider). Producers of ready-made clothing (especially suits and wedding dresses) frequently provide *tailoring* services, which are closely related to *fashion design*, which is an earlier step in the clothing production process.

5 Food, beverages and restaurant services

5.1 Ingredients of prepared food

Ingredients used for the preparation of foodstuffs are a sub-category of raw materials and treated in the same way as raw material in general. Consequently, the mere fact that one ingredient is needed for the preparation of a foodstuff will generally not be sufficient in itself to show that the goods are similar, even though they all fall under the general category of foodstuffs (judgment of 26/10/2011, T-72/10, Naty's, EU:T:2011:635, § 35-36).

Examples of dissimilarity

- *Eggs* (Class 29) and *ice cream* (Class 30)
- *Yeast* (Class 30) and *bread* (Class 30)

5.2 Main ingredient

When the ingredient can be considered as being the main ingredient of the prepared dish, a similarity will exist only if the goods share some other relevant criterion or criteria, in particular the usual origin, nature, purpose or method of use.

Examples of similarity (main ingredient plus other criteria)

- *Milk* (Class 29) and *yoghurt* (Class 29)
- *Fish* (Class 29) and *fish sticks* (Class 29)
- *Dough* (Class 30) and *pizzas* (Class 30)

See also judgment of the General Court of 04/05/2011, T-129/09, *Apetito*, EU:T:2011:193, where the Court confirms the finding of similarity between a particular foodstuff and prepared meals mainly consisting of the same particular foodstuff.

There is no complementarity in these cases simply because one ingredient is needed for the production/preparation of another foodstuff. Complementarity applies only to the use of goods and not to their production process (see chapter 'Complementarity' and judgment of 11/05/2011, T-74/10, *Flaco*, EU:T:2011:207, § 40 and decision of 11/12/2012, R 2571/2011-2, *FRUITINI*, § 18).

5.3 Non-alcoholic beverages (Class 32) versus alcoholic beverages (except beers) (Class 33)

Non-alcoholic beverages on the one hand, and *alcoholic beverages (except beers)*, are sold side by side in shops, bars and on drinks menus, etc. These goods target the same public and may be in competition. It must be concluded that these goods are similar to a low degree (judgment of 05/10/2011, T-421/10, Rosalia de Castro, EU:T:2011:565, § 31).

5.4 Beers (Class 32), alcoholic beverages (except beers) (Class 33)

There is a similarity between different alcoholic beverages in Class 33, as well as between the broad category of *alcoholic beverages* and *beer* in Class 32. Although their production processes are different, these goods all belong to the same category of alcoholic drinks (nature) intended for the general public. They can be served in restaurants and in bars and are on sale in supermarkets and grocery stores. These drinks can be found in the same area of supermarkets, even if some distinction according to their respective subcategory can be made. Furthermore, some alcoholic beverages may originate from the same undertakings.

Examples

- *Beers* are similar to *alcoholic beverages (except beers)*.
- *Wines* are similar to *alcoholic beverages (except wines)*.

5.5 Provision of food and drinks versus food and drinks

The provision of food and drinks in Class 43 mainly covers services of a restaurant or similar services, such as catering, cafeterias and snack bars. These services are intended to serve food and drinks directly for consumption.

The mere fact that food and drinks are consumed in a restaurant is not enough reason to find similarity between them (judgment of 09/03/2005, T-33/03, Hai, EU:T:2005:89, § 45 and decision of 20/10/2011, R 1976/2010-4, THAI SPA/SPA et al., § 24-26).

Nevertheless, in certain situations these goods and services can be complementary (judgments of 17/03/2015, T-611/11 Manea Spa EU:T:2015:152, § 52; 15/02/2011, T-213/09, Yorma's, EU:T:2011:37, § 46). As shown in paragraph 3.2.4 above, goods or services are complementary if one is indispensable or important for the use of the other in such a way that consumers may think that responsibility for the production of those goods or provision of those services lies with the same undertaking.

The mere fact that food and/or drinks are essential to the services of restaurants, bars, cafeterias, etc. does not in itself lead consumers to think that responsibility for the production of those goods and provision of those services lies with the same undertaking (e.g. salt in restaurants).

On the other hand, consumers may think that responsibility lies with the same undertaking if the market reality is that the provision of food and drinks and the

manufacture of such goods are commonly offered by the same undertaking under the same trade mark (e.g. coffee in their coffee shops, ice cream in their ice cream parlours, beer in pubs). In such cases, there is a low degree of similarity.

6 Services to support other businesses

All services listed in the class heading of Class 35 are aimed at supporting or helping other businesses to do or improve their business. They are therefore in principle directed at the professional public.

When comparing specific services falling within Class 35 it is very useful to focus on the question: Who is providing this kind of service? Is it an advertising agency, a management consultant, a human resources consultant, an accountant, an auditor, a sales agent or a tax advisor? Once the usual origin has been established it is easier to find the general indication to which the specific service belongs.

Advertising services consist of providing others with assistance in the sale of their goods and services by promoting their launch and/or sale, or of reinforcing the client's position in the market and acquiring competitive advantage through publicity. In order to fulfil this target, many different means and products might be used. These services are provided by advertising companies, which study their client's needs, provide all the necessary information and advice for the marketing of their products and services, and create a personalised strategy regarding the advertising of their goods and services through newspapers, websites, videos, the internet, etc.

Examples of advertising services are *rental of advertising time on communication media, telemarketing services, marketing, public relations and demonstration of goods*, since they are all intended to promote other companies' goods/services albeit via different means.

Example

Marketing research is the collection and analysis of information about a particular market to assess the viability of a product or service.

The nature and purpose of advertising services are fundamentally different from the manufacture of goods or from the provision of many other services. Therefore, advertising is generally dissimilar to the goods or services being advertised. The same applies to the comparison of advertising services versus goods that can be used as a medium for disseminating advertising, such as DVDs, software, printed matter, flyers and catalogues.

Management services are in Class 35 when they relate to the business aspects of an entity. As there are management services in other classes, a management service in Class 35 is taken to relate to business purposes.

Business management services are intended to help companies manage their business by setting out the strategy and/or direction of the company. They involve activities associated with running a company, such as controlling, leading, monitoring, organising, and planning. They are usually rendered by companies specialised in this specific field such as business consultants. They gather information and provide tools and expertise to enable their customers to carry out their business or to provide businesses with the necessary support to acquire, develop and expand market share.

Examples of business management are business research and appraisals, cost price analysis and organisation consultancy, since they are all intended to help in the strategy of a commercial undertaking. These services also include any 'consultancy', 'advisory' and 'assistance' activity that may be useful in the management of a business, such as how to efficiently allocate financial and human resources; improve productivity; increase market share; deal with competitors; reduce tax bills; develop new products; communicate with the public; do marketing; research consumer trends; launch new products and how to create a corporate identity; etc.

Examples

Business research is the analysis and interpretation of economic information, such as income, employment, taxes, and demographics. This research information is used by entrepreneurs to make business decisions such as establishing marketing strategies.

Business appraisals involve an investigation into the nature and potential of a business and an assessment of its performance in relation to its competitors.

A *cost price analysis* is a combination of both an evaluation of the proposed total price of a project and the cost of the separate elements of that project (e.g. labour, materials, etc.) to determine if they are permissible, related to the project requirements and reasonable. It is used to determine whether going ahead with a project is a sound business decision. It is therefore considered as a service that helps in the management of the business affairs or commercial functions of an industrial or commercial enterprise. Using the information gained from a cost price analysis, a business may then go on to make the financial decisions associated with engaging in the project.

When comparing *business management* to *advertising* it should be noted that advertising is an essential tool in business management because it makes the business itself known in the market. As stated above, the purpose of advertising services is 'to reinforce the [business] position in the market' and the purpose of business management services is to help a business in 'acquiring, developing and expanding market share'. There is not a clear-cut difference between 'reinforcing a business position in the market' and 'helping a business to develop and expand market share'. A professional who offers advice regarding how to efficiently run a business may reasonably include advertising strategies in that advice because there is little doubt that advertising plays an essential role in business management. Furthermore, business consultants may offer advertising (and marketing) consultancy as a part of their services and therefore the relevant public may believe that these two services have the same professional origin. Consequently, considering the above these services are similar to a low degree (decision R 2163/2010-1, INNOGAME / INNOGAMES, § 13-17). This clear overlap between the two services also follows from the definitions given above of marketing research (an advertising service) and business research (a business management service).

Business administration services are intended to help companies with the performance of business operations and, therefore, the interpretation and implementation of the policy set by an organisation's board of directors. These services consist of organising people and resources efficiently so as to direct activities toward common goals and objectives. They include activities such as personnel recruitment, payroll preparation, drawing up account statements and tax preparation, since they enable a business to perform its business functions and are usually carried out by an entity that is separate from the business in question. They are rendered by inter alia employment agencies, auditors and outsourcing companies.

Example

Business auditing involves the evaluation of a variety of business activities. It encompasses a review of organisational structures, management, processes, etc.

When comparing business administration to *advertising* it should be noted that these services are usually dissimilar, since a professional who helps with the execution of business decisions or the performance of business operations will not offer advertising strategies. However, the *organization of trade fairs for commercial or advertising purposes* is similar to a low degree to advertising, since they are both aimed at promoting the launch and/or sale of a company's products/services, and may target the same undertaking seeking help with the promotion of their products/services.

The line between *business management* and *business administration* is blurred, and it is sometimes very difficult to clearly distinguish between them. They both fall under the broader category of business services. As a general rule it can be said that business administration services are performed in order to organise and run a business, whereas business management follows a higher approach aimed at setting the common goals and the strategic plan for a commercial enterprise.

Office functions are the internal day-to-day operations of an organisation including the administration and the support services in the 'back office'. They mainly cover activities that assist in the working of a commercial enterprise. They include activities typical of secretarial services, such as shorthand and typing, compilation of information into computer databases, invoicing, administrative processing of purchase orders as well as support services, such as the rental of office machines and equipment.

Example

Book-keeping is the act of recording financial transactions.

7 Retail services

Retail is commonly defined as the action or business of selling goods or commodities in relatively small quantities for use or consumption rather than for resale (as opposed to wholesale, which is the sale of commodities in quantity, usually for resale).

However, it should be noted that the sale of goods is not a service within the meaning of the Nice Classification. Therefore, the activity of retail in goods as a service for which protection of a CTM can be obtained does not consist of the mere act of selling the goods, but in the services rendered around the actual sale of the goods, which are defined in the explanatory note to Class 35 of the Nice Classification by the terms 'the bringing together, for the benefit of others, of a variety of goods (excluding the transport thereof), enabling customers to conveniently view and purchase those goods'.

Moreover, the Court has held that the objective of retail trade is the sale of goods to consumers, which includes, in addition to the legal sales transaction, all activity carried out by the trader for the purpose of encouraging the conclusion of such a transaction. That activity consists, *inter alia*, in selecting an assortment of goods offered for sale and in offering a variety of services aimed at inducing the consumer to conclude the abovementioned transaction with the trader in question rather than with a competitor (judgment of 07/07/2005, C-418/02, Praktiker, EU:C:2005:425, § 34).

Retail services allow consumers to satisfy different shopping needs at one stop and are usually directed at the general consumer. They can take place in a fixed location, such as a department store, supermarket, boutique or kiosk, or in the form of non-shop retailing, i.e. through the internet, by catalogue or mail order.

The following principles apply as regards the similarity of the goods or services at issue.

7.1 Retail services versus any product: dissimilar

Retail services in general⁸ (i.e. the specification is not limited to the sale of particular goods) are not similar to any goods that are capable of being sold by retail. Apart from being different in nature, given that services are intangible whereas goods are tangible, they serve different needs. Furthermore, the method of use of those goods and services is different. They are neither in competition with, nor necessarily complementary to, each other.

The specification of retail services relating to the sale of goods using terms such as ‘including, in particular, for example, featuring, specifically, such as’ is not precise enough since all these terms mean, in principle, ‘for example’. They do not restrict the goods that follow. Consequently, formulations such as ‘retail services, in particular of footwear’ will be treated in the same way as ‘retail services in general’, without any specification.

7.2 Retail services of specific goods versus same specific goods: similar to a low degree

Retail services concerning the sale of particular goods are similar (to a low degree) to these particular goods (judgment of 05/10/2011, T-421/10, Rosalia de Castro, EU:T:2011:565, § 33). Although the nature, purpose and method of use of these goods and services are not the same, it should be noted that they display similarities, having regard to the fact that they are complementary and that those services are generally offered in the same places as those where the goods are offered for sale. Furthermore, they are directed at the same public.

The goods covered by the retail services and the specific goods covered by the other mark have to be identical in order to find a similarity, that is to say, they must either be exactly the same goods or fall under the natural and usual meaning of the category (e.g. ‘retail of sunglasses’ v ‘sunglasses’ and ‘retail of optical apparatus’ v ‘sunglasses’).

⁸ ‘Retail services’ as such are not acceptable for classification purposes by OHIM, unless further specified (see the Guidelines, Part B, Examination, Section 3, Classification).

7.3 Retail services of specific goods versus different or similar specific goods: dissimilar

Retail services relating to the sale of particular goods and other goods are not similar. It should be remembered that in principle goods are not similar to services. Too broad a protection would be given to retail services if similarity is found where the goods sold at retail are only highly similar or similar to the goods covered by the other mark.

7.4 Retail services versus retail services or retail services of specific goods: identical

Retail services in general, i.e. not limited in the list to the sale of particular goods, are identical to retail services in general or retail services relating to the sale of specific goods.

7.5 Retail services of specific goods versus retail services of other specific goods: similar

Retail services relating to specific goods are considered to be similar to retail services relating to other specific goods independently of whether or not there is similarity between the goods in question. The services under comparison share the same nature as both are retail services, have the same purpose of allowing consumers to conveniently satisfy different shopping needs, and have the same method of use. Furthermore, depending on whether the goods in question are commonly retailed in the same outlets, they may coincide in relevant public and distribution channels, in which case they must be considered similar.

7.6 Services to which the same principles apply

The principles set out above apply to the services rendered in connection with different forms exclusively consisting of activities around the actual sale of goods, such as **retail store services, wholesale services, internet shopping, catalogue or mail order services**, etc. (to the extent that these fall into Class 35).

7.7 Services to which the same principles do not apply

In contrast, the principles set out above do not apply to other services that are not limited to services around the sales of goods, or that do not fall into Class 35, such as **auctioneering services** (Class 35), **import and export services** (Class 35), **distribution services** (Class 39), **transport or repair services** (Class 37), etc.

Example

- ***Auctioneering services***

Auctions are public sales in which goods are sold to the highest bidder. Similarity between these services and the retail of specific products will only be found insofar as the retail services relate to goods that are commonly sold in auctions, such as objects of art.

Therefore, the specific retail or wholesale services of 'pharmaceuticals, veterinary and sanitary preparations and medical supplies' for example, would be considered dissimilar to auctioneering services, since it is not common on the market for pharmaceuticals, etc. to be sold to the highest bidder.

Example

- ***Import and export services***

Import and export services are not considered to be a sales service and thus cannot be subject to the same arguments as the comparison of goods with retail services.

Import and export services relate to the movement of goods and normally require the involvement of customs authorities in both the country of import and the country of export. These services are often subject to import quotas, tariffs and trade agreements. As they are classified in Class 35, they are considered to relate to business administration. These services do not relate to the actual retail or wholesale of the goods; they would be preparatory or ancillary to the commercialisation of such goods. For these reasons, goods are to be considered dissimilar to import and export services for those goods. The fact that the subject matter of the import/export services and the goods in question are the same is not a relevant factor for finding a similarity.

Example

- *Import and export of tobacco products (Class 35) is dissimilar to tobacco products (Class 34).*

Judgment of 09/06/2010, T-138/09, Riojavina, EU:T:2010:226, where a low degree of similarity was found between import/export of vinegar and wine, is not followed.

8 Financial services

Financial services refer to services provided by the finance industry. The finance industry encompasses a broad range of organisations that deal with the management, investment, transfer, and lending of money. Among these organisations are, for example, banks, credit card companies, insurance companies, consumer finance companies, stock brokerages and investment funds.

8.1 Banking services (Class 36) versus insurance services (Class 36)

Providing *banking services* consists of the provision of all those services carried out for savings or commercial purposes concerning the receiving, lending, exchanging, investing and safeguarding of money, issuing of notes and transacting of other financial business.

Providing *insurance services* consists of accepting liability for certain risks and respective losses. Insurers usually provide monetary compensation and/or assistance in the event that a specified contingency occurs, such as death, accident, sickness, breaking of a contract and, in general, any event capable of causing damages.

Insurance services have different purposes from the services usually provided by banks, such as providing credit or asset management, credit card services, financial evaluation or stocks and bonds brokerage. Nevertheless, they have some significant aspects in common.

Insurance services are of a financial nature, and insurance companies are subject to similar rules of licensing, supervision and solvency as banks and other institutions providing financial services. Most banks also offer insurance services, including health insurance, or act as agents for insurance companies, with which they are often economically linked. Additionally, it is not unusual to see financial institutions and an insurance company in the same economic group.

Therefore, although *insurance services* and *banking services* have different purposes, they have a similar nature, may be provided by the same undertaking or related undertakings and share the same distribution channels. These circumstances show that *insurance services* are similar to *banking services*.

8.2 Real estate affairs (Class 36) versus financial affairs (Class 36)

The term 'real estate affairs' comprises real estate property management and evaluation, and real estate agency services, as well as the consultancy and provision of information related thereto. This mainly involves finding property, making it available for potential buyers and acting as an intermediary. Consumers clearly distinguish real estate agents' services from those of financial institutions. They do not expect a bank to find housing or a real estate agent to manage their finances.

The mere fact that real estate may have to be financed in order to be purchased is not enough to find similarity between real estate affairs and financial services. Even if financial services can be important for the acquisition of real estate, the consumers usually turn first to a real estate agent to search for a property, and secondly to a financial institution to finance the property.

Any other conclusion would mean that all non-financial transactions subject to funding would be complementary to a financial service. It must therefore be concluded that these services are dissimilar even if financial services are essential or important for the use of real estate. The consumers would not attribute responsibility for both services to the same company. (judgment of 11/07/2013, T-197/12, Metro, EU:T:2013:375, § 47-51).

8.3 Credit cards (Class 9) versus financial services (Class 36)

A credit card is a small plastic card issued to users as a system of payment. It allows its holder to buy goods and services based on the holder's promise to pay for these goods and services. The issuer of the card creates a revolving account and grants a line of credit to the consumer (or the user) from which the user can borrow money for payment to a merchant or as a cash advance to the user.

Financial services are offered by institutions like banks for the facilitation of various financial transactions and other related activities in the world of finance.

Even though credit cards are related to some extent to financial services, for example they can be used to withdraw money from the cash dispenser of a bank, this link is too remote to render the goods and services similar. The customers are aware of the fact that financial institutions are not responsible for the technological aspects of issuing magnetic or chip cards (decision of 07/05/2012, R 1662/2011-5, CITIBANK, § 29).

9 Transport, packaging and storage

9.1 Transport of goods (Class 39) versus any product

Services of *transport* are not considered to be similar to goods. These services are provided by specialist transport companies whose business is not the manufacture and sale of those goods. As regards the nature of the goods and services, *transport services* refer to a fleet of trucks or ships used to move goods from A to B.

Example

- *Pastry and confectionery* are dissimilar to *transport services*. They are different in terms of their nature, intended purpose and method of use; they are neither complementary nor in competition. All these differences explain why the service of transport and the goods of pastry and confectionery target different consumers. Transport is predominantly aimed at professionals (those who need to move goods) whereas pastry and confectionery target non-professional consumers (ordinary people who require food) (decision of 07/01/2014, R 1006/2012-G, PIONONO, § 28-36).

9.2 Packaging and storage of goods (Class 39) versus any product

Equally, *packaging and storage services* merely refers to the service whereby a company's or any other person's goods are packed and kept in a particular place for a fee. Those services are not similar to any kind of goods, including any of the goods that may be packaged and stored (judgments of 07/02/2006, T-202/03, Comp USA, EU:T:2006:44; 22/06/2011, T-76/09, Farma Mundi Farmaceuticos Mundi, EU:T:2011:298, § 32 and decision of 07/01/2013, R 1006/2012-G, PIONONO, § 38).

10 Information Technology

10.1 Computers versus software

What we call a *computer* is actually a 'system', a combination of components that work together. The hardware devices are the physical components of that system. The hardware is designed to work hand in hand with *computer programs*, referred to as *software*. Computer hardware companies also manufacture software, share the same distribution channels and target the professional public (e.g. for use in banking and finance, education, medicine, business and entertainment/recreation) and/or the general public. Moreover, they are complementary (see paragraph 10.2 below). These goods are considered to be similar.

10.2 Software versus apparatus that use software

In today's high-tech society almost all *electronic or digital apparatus* function using integrated *software*. This does not, however, lead to the automatic conclusion that software is similar to goods that use software to function successfully (see also Annex I, paragraph 1. Parts, components and fittings).

Example of dissimilarity

- Although *digital scale* functions using integrated *software*, this does not lead to the conclusion that software and scales are similar. One could argue that the software is important for the use of the scale; however, they are not complementary because they are not aimed at the same public. The digital scale is for the general public, whereas the software is aimed at the actual manufacturer of these scales. The producers are not the same, nor are the distribution channels, and they do not have the same purpose.

However, when the software is not an integrated part of an apparatus, can be purchased independently from it and serves e.g. to give more or different functionalities, similarity can be established.

Example of similarity

- A *digital camera* and *software* to increase its functionalities are both aimed at the same public and produced by the same or related undertakings. They are distributed through the same channels and use of the one is indispensable for use of the other. Consequently, *digital cameras* and *software* (which includes software to e.g. increase functionalities of a digital camera) are considered to be similar.

10.3 Software, downloadable 'apps' and downloadable electronic publications

Application software, also known as 'an app', is *computer software* that is designed to help the user perform various tasks on the computer. Application software differs from system software in that it can be accessed by the user and run on the computer. Application software is usually designed with the user in mind. The new definition of *application* is used to refer to the small 'apps' that are designed for mobile phones; however, the definition covers all applications on smart phones, tablets and computers. Consequently, *software*, *application software* and *downloadable applications* are considered to be identical.

Downloadable electronic publications are electronic versions of traditional media, like e-books, electronic journals, online magazines, online newspapers, etc. It is becoming common to distribute books, magazines and newspapers to consumers through tablet reading devices by means of so-called 'apps' in the form of electronic publications. Consequently, there is a complementary relationship between software/'apps' and downloadable electronic publications. Their producers can be the same; they follow the same distribution channels and the public is generally also the same. These goods are considered to be similar.

10.4 Specific software versus specific software

There are many types of software, and although software by nature (a set of instructions that enables a computer to perform a task) is the same, this does not mean that their specific purpose is the same. This implies that very specific software could even be dissimilar to another type of software.

Example

The field of application of *computer games software* is not the same as *software for apparatus that diagnose diseases*. Due to these significantly different fields of application, the expertise needed to develop these types of software is not the same, nor are their end users or distribution channels. These goods are therefore dissimilar.

10.5 Computers and software (Class 9) versus computer programming (Class 42)

Computer programming consists, inter alia, of the process of writing source code (judgment of 29/03/2012, T-417/09, Mercator Studios, EU:T:2012:174 § 26), and a computer program is a set of coded instructions that enables a machine, especially a computer, to perform a desired sequence of operations.

Computers are devices that compute, especially programmable electronic machines that perform high-speed mathematical or logical operations or that assemble, store, correlate, or otherwise process information. Computers need programs to operate.

Software is composed of programs, routines, and symbolic languages that control the functioning of the hardware and direct its operation.

Therefore, *computer programming services* are closely linked to *computers* and *software*. This is because in the field of computer science, producers of computers and/or software will also commonly provide computer and/or software-related services (as a means of keeping the system updated, for example).

Consequently, and in spite of the fact that the nature of the goods and services is not the same, both the end users and the producers/providers of the goods and services coincide. Furthermore, they are goods and services that are complementary. For these reasons these goods and services are considered similar.

10.6 Apparatus for recording, transmission, reproduction of sound or images, computers and software (Class 9) versus telecommunication services (Class 38)

Apparatus for recording, transmission or reproduction of sound or images are apparatus and devices used to communicate audio or video information over a distance via radio waves, optical signals, etc., or along a transmission line.

Telecommunication services are those that allow people to communicate with one another by remote means.

Since the 1990s the boundary between *telecoms equipment* and *IT hardware/software* has become blurred as a result of the growth of the internet and its increasing role in the transfer of telecoms data. Equipment used for purposes of telecommunication, like modems, mobile phones, landline telephones, answering machines, fax machines, pagers, routers, etc. is also considered to cover the telecommunications control software that must be in place to successfully support telecommunications activities. Any software that provides the ability to perform telecommunication activities operations can be considered telecommunications control software.

Clearly, a link exists between the above goods in Class 9 and telecommunication services in Class 38. These goods and services are similar given their complementary character; although their nature is different, their purpose and distribution channels are the same (judgment of 12/11/2008, T-242/07, Q2web, EU:T:2008:488, § 24-26).

***GUIDELINES FOR EXAMINATION IN THE
OFFICE FOR HARMONIZATION IN THE
INTERNAL MARKET (TRADE MARKS AND
DESIGNS) ON COMMUNITY TRADE MARKS***

PART C

OPPOSITION

SECTION 2

***DOUBLE IDENTITY AND
LIKELIHOOD OF CONFUSION***

CHAPTER 3

***RELEVANT PUBLIC AND
DEGREE OF ATTENTION***

Table of Contents

1	Introduction.....	3
2	Defining the Relevant Public	4
3	Defining the Degree of Attention.....	9
3.1	Higher degree of attention.....	10
3.1.1	Expensive purchases	10
3.1.2	Potentially hazardous purchases.....	11
3.1.3	Brand loyalty.....	11
3.1.4	Pharmaceuticals	11
3.2	Lower degree of attention.....	11

1 Introduction

With regard to the relevant public, the Court of Justice has held that a likelihood of confusion (including a likelihood of association) exists if there is a risk that the public might believe that the goods or services in question come from the same undertaking or, as the case may be, from economically linked undertakings (judgment of 29/09/1998, C-39/97 Canon, EU:C:1998:442, § 29). The Court has also held that it is the **perception of marks in the mind of the relevant public of the goods or services in question** that plays a decisive role in the global assessment of the likelihood of confusion (judgments of 11/11/1997, C-251/95, Sabèl, EU:C:1997:528, § 23; 22/06/1999, C-342/97, Lloyd Schufabrik, EU:C:1999:323, § 25).

Accordingly, the first task is to define the consumer circles that are relevant for the purposes of the case. The method for identifying the relevant public is discussed in paragraph 2. Thereafter, the relevant public's degree of attention and sophistication must be established. The impact of the relevant public's attention and sophistication on the assessment of the likelihood of confusion is discussed in paragraph 3.

In addition, the relevant public plays an important role in establishing a number of other factors that are relevant for the assessment of the likelihood of confusion.

- *Comparison of the goods and services*

The actual and potential customers of the goods and services in dispute constitute one of the factors to be dealt with in the analysis of their similarity. While a coincidence in the relevant public is not necessarily an indication of similarity of the goods or services, largely diverging publics weigh heavily against similarity¹.

Example

Leather, animal skins and hides are raw materials that go to industry for further processing, whereas *goods made of leather* are final products targeted at the general public. The relevant public is different, which is a fundamental factor in the assessment of similarity and which leads to the conclusion that the goods in question are dissimilar. Similar reasoning applies to *precious metals* and *jewellery*.

- *Comparison of the signs*

The question of the relevant public also plays a role in the comparison of the signs. The same word may be pronounced differently depending on the relevant public. Conceptually, the public in one part of the European Union may understand the meaning of the sign, while consumers in other parts may not understand it².

¹ See the Guidelines, Part C, Opposition, Section 2, Double Identity and Likelihood of Confusion, Chapter 2, Comparison of Goods and Services.

² See the Guidelines, Part C, Opposition, Section 2, Double Identity and Likelihood of Confusion, Chapter 3, Comparison of Signs.

Example

The Court has already confirmed that the general public in the Scandinavian countries, the Netherlands and Finland has a basic understanding of English (judgment of 26/11/2008, T-435/07, *New Look*, EU:T:2008:534, § 23).

- *Distinctive elements of the sign/distinctiveness of the earlier mark*

The inherent distinctiveness of a sign or one of its elements also depends on the relevant public for the goods and services. For example, depending on the relevant public's knowledge, background and language, an element contained in a trade mark may be non-distinctive or have a low degree of distinctiveness, or it may be distinctive because, inter alia, it is perceived as a fanciful term without any meaning claimed³.

Example

The French word 'cuisine' will not be understood as a descriptive indication for goods in Classes 29 and 30 in some Member States (decision of 23/06/2010, R 1201/2009-1, *GREEN CUISINE*, § 29-33).

Example

Professionals in the IT field and scientific field are in general more familiar with the use of technical and basic English words than the general public: In *Gateway versus Activy Media Gateway*, the Court held that the common word 'gateway' directly evokes, in the mind of the relevant consumer, the concept of a gateway, which is commonly used in the computing sector (judgment of 27/11/2007, T-434/05, *Activy Media Gateway*, EU:T:2007:359, § 38, 48, confirmed by appeal, C-57/08 P).

2 Defining the Relevant Public

In accordance with Article 8(1)(b) CTMR, it must be determined whether a likelihood of confusion exists 'on the part of the public in the territory where the earlier mark is protected'.

According to the Court, this wording shows that the perception of the marks in the mind of the **average consumer** of the type of goods or services in question plays a decisive role in the overall appreciation of the likelihood of confusion (judgments of 11/11/1997, C-251/95, *Sabèl*, EU:C:1997:528, § 23; 22/06/1999, C-342/97, *Lloyd Schuhfabrik*, EU:C:1999:323, § 25).

The term '**average consumer**' is a legal concept that is used in the sense of the 'relevant consumer' or '**relevant public**'. It should not be confused with the 'general public' or 'public at large', although the Courts sometimes use it in this sense. However, in the context of relative grounds, the term 'average consumer' must not be used as a synonym of 'general public' as it can refer to both, **professional** and **general public**. In this respect, in cases concerning the likelihood of confusion, the Court normally distinguishes between the *general public (or public at large)*, and a *professional or*

³ See the Guidelines, Part C, Opposition, Section 2, Double Identity and Likelihood of Confusion, Chapter 5, Distinctiveness of the Earlier Mark.

specialised public (or business customers), based on the goods and services in question.

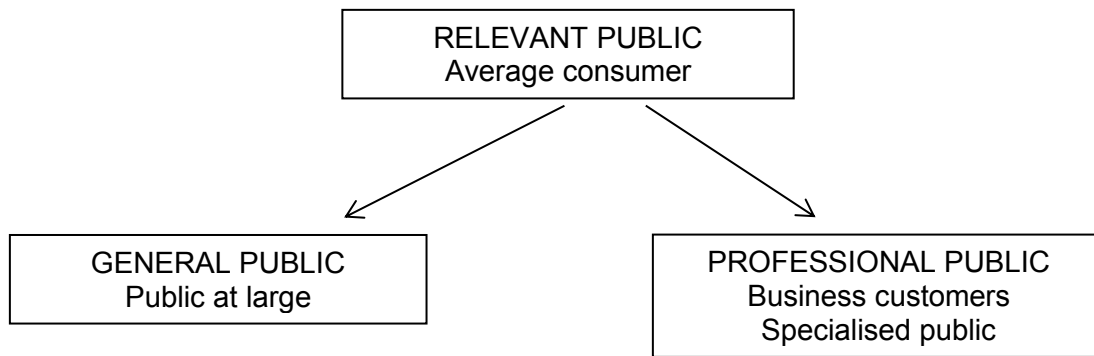

In order to properly define the relevant public in the context of relative grounds, two factors have to be taken into account:

- **the territory defined by the earlier mark:** the relevant public is always the public in the territory(ies) where the earlier right(s) is/are protected. Consequently, in the case of an earlier national right, the relevant public concerned is the one of that particular EU Member State (or Member States in the case of Benelux trade marks). For an earlier Community trade mark, the public in the whole European Union has to be taken into account. For an international registration, it is the public in each of the Member States where the mark is protected.
- **the goods and services that have been found identical or similar:** likelihood of confusion is always assessed against the perception of the consumers of the goods and services that have been found identical or similar. Depending on the goods or services, the relevant public is the general public or a professional/specialised public.

The relevant public always includes both the **actual** and the **potential** consumers, that is, the consumers who are currently purchasing the goods/services or who may do so in the future.

If a **significant part of the relevant public** for the goods or services at issue may be confused as to the origin of the goods, this will be sufficient to establish a likelihood of confusion. It is not necessary to establish that all actual or potential consumers of the relevant goods or services are likely to be confused.

As stated by the Court, the relevant public for the assessment of the likelihood of confusion is composed of **users likely to use both the goods and services covered by the earlier mark and the product covered by the mark applied for that were found to be identical or similar** (judgment of 01/07/2008, T-328/05, Quartz, EU:T:2008:238, § 23, C-416/08 P, appeal dismissed).

When defining the part of the public **by reference to which a likelihood of confusion is assessed** the following applies:

- If the goods or services of both marks target the general public, the relevant public by reference to which a likelihood of confusion will be assessed is the general public.

Example

In a case in which both the earlier and the contested mark concerned articles of clothing, the Court held that 'clothing for men and women are everyday consumer items and the trade mark on which the opposition is based is registered as a Community trade mark. It follows that the relevant public by reference to which the likelihood of confusion must be assessed is composed of the general public in the European Union' (judgments of 06/10/2004, T-117/03 to T-119/03 and T-171/03, NL, EU:T:2004:293, § 25).

- If the goods and services of both marks are directed at the same or a similar professional public, the likelihood of confusion will be assessed from the perspective of those specialists.

Example

The relevant goods of both the earlier and the contested mark were raw plastic materials, chemical products, resins and the like. These are goods for industrial use. The targeted consumers are, therefore, engineers and/or chemists, that is to say, highly skilled professionals who will process these products and use them in manufacturing activities. The relevant public was considered to be professional (decision of 15/02/2012, R 2077/2010-1, PEBAFLEX, § 18. See also decision of 16/09/2010, R 1370/2009-1, CALCIMATT, § 20, confirmed by judgment of 29/03/2012, T-547/10, EU:T:2012:178).

- If the goods or services of both marks target both the general public and specialists, the likelihood of confusion will be assessed against the perception of the part of the public displaying the lower degree of attentiveness as it will be more prone to being confused. If this part of the public is not likely to be confused, it is even more unlikely that the part of the public with a higher degree of attention will be.

Example

In a case in which both the earlier and the contested mark concerned goods in Classes 3 and 5 that targeted both the general public and professionals (e.g. doctors for pharmaceuticals in Class 5), the Court assessed the likelihood of confusion for the general public only, because it is the one displaying the lower degree of attention (judgment of 15/07/2011, T-220/09, ERGO, EU:T:2011:392, § 21).

- If the goods and services of the earlier mark target the general and professional public and the contested goods and services target a professional public exclusively (or vice versa), the relevant public for assessing likelihood of confusion will be the professional public only.

Example

The goods of the earlier mark are *polish for metals*, while the goods of the application are *preparations for cleaning waste pipes for the metal-working industry*. As stated in the relevant GC judgment: 'Although "polish for metals" can consist equally well of everyday consumer goods as of goods intended for a professional or specialised public, it is not disputed that the goods to which the trade mark application relates must be regarded as directed solely at persons operating in the metal-working industry. Therefore, the only public likely to confuse the trade marks in question is formed of such operators' (judgment of 14/07/2005, T-126/03, Aladin, EU:T:2005:288, § 81).

Example

Paints in general are sold both to professional painters (i.e. for business purposes) and to the public at large for 'do-it-yourself purposes'. By contrast, *paints for industry* do not target the general public. Therefore, when the specifications of the two marks cover paints and paints for industry respectively, only professionals constitute the relevant public since they are likely to be the only consumers who encounter both marks.

Example

The services of the earlier mark are *telecommunications*. The contested services are *telecommunication services, namely collocation, telehousing and interconnection services* addressed at professionals only. The definition of the relevant public must be adjusted to the more specific list, and likelihood of confusion should be assessed for professionals only (judgment of 24/05/2011, T-408/09, ancotel, EU:T:2011:241, § 38-50).

- If the relevant goods are pharmaceuticals the following applies:

The average consumer of **non-prescription** pharmaceuticals (sold over the counter) is the general public, and the likelihood of confusion will be assessed in relation to that public.

According to the case-law, the general public cannot be excluded from the relevant public, also in the case of pharmaceuticals that require a **doctor's prescription** prior to their sale to end-users in pharmacies. Thus, the relevant public comprises both general public and health professionals, such as doctors and pharmacists. Consequently, even though the choice of those products is influenced or determined by intermediaries, a likelihood of confusion can also exist for the general public, since they are likely to be faced with those products, even if that takes place during separate purchasing transactions for each of those individual products at various times (judgments of 09/02/2011, T-222/09, Alpharen, EU:T:2011:36, § 42-45; 26/04/2007, C-412/05 P, Travatan, EU:C:2007:252, § 56-63). In practice, this means that the likelihood of confusion will be assessed against the perception of the general public, which is more prone to confusion.

In the case of pharmaceutical goods **targeted only at specialists** for professional use (e.g. *sterile solutions for ophthalmic surgery*), the likelihood of confusion must be assessed from the point of view of that specialist public only (judgment of 26/04/2007, C-412/05 P, Travatan, EU:C:2007:252, § 66).

In cases where the pharmaceutical goods of the CTM application are **sold over the counter**, while the pharmaceutical goods covered by the earlier registration would **only be available on prescription, or vice versa**, the Office must assume that the relevant public consists of both qualified professionals and the general public, without any specific medical and pharmaceutical knowledge. The likelihood of confusion will be assessed in relation to the general public, which is more prone to confusion.

Example

The goods covered by the earlier mark were pharmaceutical preparations with *digoxin for human use for cardiovascular illnesses*, while the contested goods were *pharmaceutical preparations for the treatment of metabolic disorders adapted for administration only by intravenous, intra-muscular or subcutaneous injection*.

Although both the goods of the earlier mark and the goods of the contested mark are prescribed by and administered under the supervision of healthcare professionals, the GC held that the relevant public comprises both healthcare professionals and the general public.

(Judgment of 23/09/2009, in joined cases T-493/07, T-26/08 and T-27/08, Famoxin, EU:T:2009:355, § 50-54 (C-461/09 P, appeal dismissed)).

3 Defining the Degree of Attention

The Court has indicated that for the purposes of the global assessment, the average consumer of the products concerned is deemed to be **reasonably well-informed** and **reasonably observant and circumspect**, and that the relevant public's degree of attention is likely to vary according to the category of goods or services in question (C-342/97, Lloyd Schuhfabrik, EU:C:1999:323, § 26).

Whether its degree of attention will be **higher or lower will depend, inter alia, on the nature of the relevant goods and services and the knowledge, experience and purchase involvement of the relevant public.**

The fact that the relevant public consists of the *general public* does not necessarily mean that the degree of attention cannot be high (for instance, when expensive, potentially hazardous or technically sophisticated goods are purchased). Likewise, the fact that the goods at issue target *specialists* does not necessarily mean that the degree of attention is high. In some cases the professional public may have a high degree of attention when purchasing a specific product. This is when these professional consumers are considered to have special background knowledge or experience in relation to the specific goods and services. Moreover, purchases made by professional consumers are often more systematic than the purchases made by the general public. However, this is not always the case. For example, if the relevant goods or services are used by a given professional on a daily basis, the level of attention paid may be average or even low.

Properly defining the degree of attention of the relevant public is necessary, as this factor can weigh for or against a finding of a likelihood of confusion. Whilst the relevant public only rarely has the chance to make a direct comparison between the different signs and must rely on an '*imperfect* recollection' of them, a high level of attention of the relevant public may lead to conclude that it will not confuse the marks, despite the lack of direct comparison between the trade marks (judgment of 22/03/2011, T-486/07, CA, EU:T:2011:104, § 95). Therefore, the degree of attention will be established in the decision.

However, **a high degree of attention does not automatically lead to a finding of no likelihood of confusion.** All the other factors have to be taken into account (*interdependence principle*)⁴. For example, in view of the specialised nature of the relevant goods and/or services and the high degree of attention of the relevant public, likelihood of confusion may be ruled out (judgment of 26/06/2008, T-79/07, Polaris, EU:T:2008:230, § 50-51). However, a likelihood of confusion can exist despite a high degree of attention. For example, when there is a strong likelihood of confusion created by other factors, such as identity or close overall similarity of the marks and the identity of the goods, the attention of the relevant public alone cannot be relied upon to prevent confusion (judgment of 21/11/2013, T-443/12, ancotel, EU:T:2013:605, § 53-56; decision of 06/09/2010, R 1419/2009-4, Hasi).

⁴ See the Guidelines, Part C, Opposition, Section 2, Double Identity and Likelihood of Confusion, Chapter 8, Global Assessment.

3.1 Higher degree of attention

A higher degree of attention is usually connected with the following types of purchases: expensive purchases, the purchase of potentially hazardous or technically sophisticated goods. The average consumer often seeks professional assistance or advice when choosing or buying certain types of goods and services (e.g. cars, pharmaceutical products).

A higher degree of attention can also apply to goods when brand loyalty is important for the consumer.

3.1.1 Expensive purchases

When purchasing expensive goods, the consumer will generally exercise a higher degree of care and will buy the goods only after careful consideration. Non-specialised or non-professional consumers often seek professional assistance or advice when choosing or buying certain types of goods and services. The attention may be enhanced in cases of luxury goods and where the specific product is regarded as reflecting the social status of its owner.

Examples

- Cars. Taking into consideration their price, consumers are likely to pay a higher degree of attention than for less expensive purchases. It is to be expected that these consumers will not buy a car, either new or second-hand, in the same way as they would buy articles purchased on a daily basis. The consumer will be an informed one, taking all relevant factors into consideration, for example, price, consumption, insurance costs, personal needs or even prestige. See in this respect the GC judgments of 22/03/2011, T-486/07, CA, EU:T:2011:104, § 27-38; 21/03/2012, T-63/09, Swift GTi, EU:T:2012:137, § 39-42.
- Diamonds, precious and semi-precious stones. In its decision of 09/12/2010, R 0900/2010-1, Leo Marco, § 22, the Board held that consumers generally put a certain amount of thought into the selection of these goods. In many cases the goods will be luxury items or will be intended as gifts. A relatively high degree of attention on the part of the consumer may be assumed.
- Financial services. These services target the general public, which is reasonably well-informed and reasonably observant and circumspect. However, since such services are specialised services that may have important financial consequences for their users, the consumers' level of attention would be rather high when choosing them (decision of 03/02/2011, R 0719/2010-1, f@ir Credit, § 15) (Appeal before GC, T-220/11, dismissed. Appealed C-524/12 P dismissed).

In the overall impression combined by the signs at issue, the visual and conceptual differences between the signs are sufficient to outweigh their limited phonetic similarity, particularly since the relevant public is highly attentive and well informed (judgment of 22/06/2010, T-563/08, Carbon Capital Markets, EU:T:2010:251, § 33, 61).

- Real-estate services. The purchase and sale of property are business transactions that involve both risk and the transfer of large sums of money. For

these reasons, the relevant consumer is deemed to possess a higher-than-average degree of attention, since the consequences of making a poor choice through lack of attentiveness might be highly damaging (decision of 17/02/2011, R 817/2010-2, FIRST THE REAL ESTATE, § 21).

3.1.2 Potentially hazardous purchases

The impact on safety of goods covered by a trade mark (for example, firelighters, saws, electric accumulators, electric circuit breakers, electric relays, etc.) may result in an increase in the relevant consumer's degree of attention (judgment of 22/03/2011, T-486/07, CA, EU:T:2011:104, § 41).

3.1.3 Brand loyalty

Furthermore, a higher degree of attention can be the consequence of brand loyalty.

Example

Although tobacco products are relatively cheap articles for mass consumption, smokers are considered particularly careful and selective about the brand of cigarettes they smoke, so a higher degree of brand loyalty and attention is assumed when tobacco products are involved. Therefore, in the case of tobacco products a higher degree of similarity of signs may be required for confusion to occur. This has been confirmed by several Board decisions: decision of 26/02/2010, R 1562/2008-2, victory slims, where it was stated that the consumers of Class 34 goods are generally very attentive and brand loyal, and decision of 25/04/2006, R 0061/2005-2, Granducato.

3.1.4 Pharmaceuticals

It is apparent from the case-law that, insofar as pharmaceutical preparations are concerned, the relevant public's degree of attention is relatively high, whether or not issued on prescription (judgments of 15/12/2010, T-331/09, Tolposan, EU:T:2010:520, § 26; 15/03/2012, T-288/08, Zydus, EU:T:2012:124, § 36 and quoted case-law).

In particular, *medical professionals* have a high degree of attentiveness when prescribing medicines. With regard to *non-professionals*, they also show a higher degree of attention, regardless of whether the pharmaceuticals are sold without prescription, as these goods affect their state of health.

3.2 Lower degree of attention

A *lower degree of attention* can be associated, in particular, with habitual buying behaviour. Purchase decisions in this area relate to, for example, inexpensive goods purchased on a daily basis (judgment of 15/06/2010, T-547/08, Strumpf, EU:T:2010:235, § 43).

The mere fact that the relevant public makes an impulse purchase of some goods (for example, sweets) does not mean that the level of that public's attention is lower than average (judgment of 09/04/2014, T-623/11, Milanówek cream fudge, EU:T:2014:199, § 34).

***GUIDELINES FOR EXAMINATION IN THE
OFFICE FOR HARMONIZATION IN THE
INTERNAL MARKET (TRADE MARKS AND
DESIGNS) ON COMMUNITY TRADE MARKS***

PART C

OPPOSITION

SECTION 2

***DOUBLE IDENTITY AND LIKELIHOOD OF
CONFUSION***

CHAPTER 4

COMPARISON OF SIGNS

Table of Contents

1	General Principles of the Trade Mark Comparison.....	4
1.1	Overview	4
1.2	Structure	4
1.3	Three aspects: visual, aural and conceptual	5
1.4	Possible outcome of the comparison	5
1.5	Signs to be compared and negligible elements	6
1.6	Relevant territory and relevant public.....	8
2	Identity of Signs.....	9
2.1	The concept of identity	9
2.2	Threshold for a finding of identity.....	9
2.3	Identity of word marks	10
2.4	Word marks and figurative marks	12
2.5	Identity of figurative marks.....	12
2.6	Identity of an earlier black and white (B&W) or greyscale mark with a colour mark application	13
3	Similarity of Signs	15
3.1	Introduction	15
3.2	Distinctive elements of the marks	15
3.2.1	What is a component of a sign?	16
3.2.2	Examination of distinctiveness	16
3.2.3	Specific cases.....	22
3.3	Dominant elements of the marks	24
3.4	Comparison of signs.....	27
3.4.1	Visual comparison	27
3.4.2	Phonetic comparison	35
3.4.3	Conceptual comparison: practical criteria	43
3.4.4	How to make a conceptual comparison	54
3.4.5	Impact of the distinctive and dominant character of the components on the similarity of signs	59
3.4.6	Other principles to be taken into account in the comparison of signs	64
3.5.	Conclusion on similarity	73
4	Dissimilarity of Signs	75
4.1	Introduction	75
4.2	Scenarios for dissimilarity.....	76
4.2.1	No element in common.....	76
4.2.2	Overlap in a negligible element	76
4.2.3	Overlap in a verbal element not noticeable due to high stylisation	76
4.2.4	Overlap in other irrelevant aspects.....	77

4.2.5 Overlap in a non-distinctive element 79

1 General Principles of the Trade Mark Comparison

1.1 Overview

This chapter deals with the comparison of signs. The purpose of comparing signs is to determine if the signs are identical (see paragraph 2 below), similar (see paragraph 3 below), or dissimilar (see paragraph 4 below).

The identity of trade marks is a prerequisite for applying the provision of Article 8(1)(a) CTMR ('double identity'). Goods or services have to be identical too.

The similarity (or identity) of signs is a necessary condition for it to be found that there is a likelihood of confusion for the purposes of Article 8(1)(b) CTMR (judgment of 23/01/2014, C-558/12 P, *Western Gold*, EU:C:2014:22, § 44). If the signs are dissimilar, an examination of likelihood of confusion will stop at this point.

Whether a likelihood of confusion exists depends on an assessment of several interdependent factors, including (i) similarity of the goods and services, (ii) the relevant public, (iii) **similarity of the signs**, taking into account their distinctive and dominant elements and (iv) the distinctiveness of the earlier mark.

1.2 Structure

A global appreciation of the visual, aural or conceptual similarity of the marks in question must be based on the overall impression given by them, bearing in mind their distinctive and dominant components (C-251/95, *Sabèl*, EU:C:1997:528, § 23). A comparison of trade marks must integrate, therefore, an assessment of the distinctive character and dominance of their elements, and the impact of their overall impression.

A comparison of trade marks must contain the following considerations: an assessment of the distinctive and dominant character of the coinciding and differing elements, their commonalities and differences, and a final conclusion that is reached after the assessment of the impact of distinctive/dominant elements on the overall impression of the signs.

The order of the examination at the '**comparison of signs**' stage **should not be predetermined** but rather, depending on the particular context, adjusted to provide logical coherence to the decision. Nevertheless, with the aim of having a consistent decision format that follows, where possible, a similar structure, the following order is apt for the majority of cases when signs are not identical (see paragraph 2 below):

i. Representation/Description of the signs:

As a preliminary step, the signs should be portrayed in a table, followed by a short description of the marks (no need for word marks). The purpose of this chapter is to identify the type of signs (words marks, figurative marks) and their elements in order to establish a framework for comparison ('what is there?').

ii. Inherent distinctiveness/dominance of elements of both marks:

As a second step, an assessment of **inherent distinctiveness and dominance of the components** is carried out. The purpose of this chapter is to identify the degree of

relevance of the components for the comparison of signs, for example, whether the distinctiveness of the common element is limited.

Importantly, the **distinctiveness of the earlier mark as a whole (including the issue of acquired distinctiveness)** should **not** be taken into account when comparing signs. The assessment of the distinctiveness of the earlier mark **as a whole** is addressed under a separate heading¹.

iii. Comparison of signs taking into account the previously established inherent distinctiveness and the dominant character of the components and final conclusion:

The third step entails the comparison of marks at a **visual, aural and conceptual** level, considering and integrating the previous findings on the distinctiveness/dominance of the components.

1.3 Three aspects: visual, aural and conceptual

Signs are compared at three levels, namely visually (see paragraph 3.4.1 below), aurally (see paragraph 3.4.2 below) and conceptually (see paragraph 3.4.3 below). This is because one can perceive signs visually, aurally and conceptually (if they evoke a concept). Only when it is not possible to compare at one level (e.g. the aural comparison when both marks are purely figurative) will this aspect be left out. If there is similarity at one or more of the three levels, then the signs are similar (judgment of 02/12/2009, T-434/07, Solvo, EU:T:2009:480, § 50-53).

1.4 Possible outcome of the comparison

The comparison of signs leads to the finding of one of the following three outcomes: identity, similarity or dissimilarity. The result is decisive for further examination of the opposition as it has the following implications:

- a finding of **identity** between signs leads to absolute protection according to Article 8(1)(a) CTMR if the goods and/or services are also identical.
- a finding of **similarity (or identity)** leads to the opening of the examination on likelihood of confusion in accordance with Article 8(1)(b) CTMR.
- the finding of **dissimilarity** in all three aspects excludes the likelihood of confusion. There is no need to examine further prerequisites of Article 8(1)(b) CTMR.

The comparison has to lead to a finding on the **degree of this similarity** in every aspect of the comparison.

- The **finding on the level of similarity of the marks can be decisive** for the outcome of the decision. The examiner should be aware, that not 'any similarity' can lead to likelihood of confusion, even for identical goods and/or services (interdependence principle). The finding of the level of similarity of the marks will make the decision more understandable. For example, the final finding that there

¹ The Guidelines, Part C, Opposition, Section 2, Double Identity and Likelihood of Confusion, Chapter 5, Distinctiveness of the Earlier Mark.

is no likelihood of confusion for identical/highly similar goods and/or services is easier to understand in the overall assessment if the marks were previously held as only ‘similar to a low degree’.

- **It is especially important to emphasise in each comparison the degree of similarity of marks if it is high (above average) or low (below average). However, even if the level of similarity is average, the decision should state this, to avoid misunderstandings.** A mere statement that ‘the marks are similar’ is not clear as it can be interpreted in two ways — either in the sense that they are similar to an average degree, or just in the general sense that there is (some) similarity allowing for further examination. If the word ‘similar’ is used without further qualification, the meaning shall be explained.

The three levels of similarity are low/average/high. Synonyms can be used as far as they are clear (e.g. average = medium), however, it has to be noted that the term ‘enhanced’ is not a synonym for ‘high’. Moreover, nothing prohibits examiners from assessing the similarity further, like ‘only very low’ or ‘high degree of similarity, almost identical’ if this supports the outcome. The wording, however, must be as clear as possible. This is not the case for expressions like ‘not particularly high’, which can be understood in two ways — in this example not as high as ‘average’ or just ‘low’.

- The **level of similarity must be established for each aspect of the comparison** (visual/phonetic/conceptual) separately. The particular field (e.g. the visual or phonetic similarity) may be decisive depending on how the goods are purchased².
- After the level of similarity has been defined (individually for the visual, phonetic and conceptual comparison), a conclusion can be added (if applicable), stating that ‘since the marks have been found similar in at least one aspect of comparison’, the examination of the likelihood of confusion will proceed.

1.5 Signs to be compared and negligible elements

When assessing identity or similarity, the signs have to be compared in the form in which they are protected, that is, in the form in which they are registered/applied for. The actual or possible use of the registered marks in another form is irrelevant when comparing signs (judgment of 09/04/2014, T-623/11, Milanówek cream fudge, EU:T:2014:199, § 38)³.

The comparison must **cover signs in their entirety**. Consequently, it is wrong to discard comparing elements of signs just because they are, for example, smaller than other elements in the signs (unless they are negligible as explained below) or because they are non-distinctive (judgments of 12/06/07, C-334/05 P, Limoncello, EU:C:2007:333, § 41-42; 13/12/2011, T-61/09, Schinken King, EU:T:2011:733, § 46).

Exceptionally, in the event of **negligible elements**, the Office may decide not to take such elements for the purposes of the actual comparison, after **having duly reasoned**





² See the Guidelines, Part C, Opposition, Section 2, Double Identity and Likelihood of Confusion, Chapter 7, Global Assessment, paragraph 4, Impact of the method of purchase of goods and services.

³ For the effect of disclaimers, see the Guidelines, Part C, Opposition, Section 2, Double Identity and Likelihood of Confusion, Chapter 5, Distinctiveness of the Earlier Mark.

why they are considered negligible (judgment of 12/06/2007, C-334/05 P, Limoncello, EU:C:2007:333, § 42). This is especially important where the negligible element is the common element in the signs. The notion of negligible elements should be interpreted strictly and, in the event of any doubt, the decision should cover the signs in their entirety.

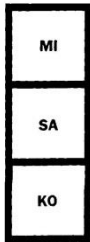
The Office considers that a negligible element refers to an element that, due to its size and/or position, is not noticeable at first sight or is part of a complex sign with numerous other elements (e.g. beverage labels, packaging, etc.) and, therefore, very likely to be disregarded by the relevant public.

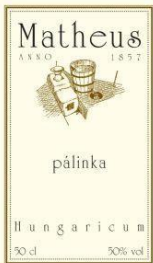
Examples:

Earlier sign	Contested sign	Case No
		<p>T-162/08</p> <p>The words 'by missako' are almost illegible: the size and script make them difficult to decipher.</p>
	<p>LUNA</p>	<p>R 02347/2010-2</p> <p>The element 'Rótulos Luna S.A.' was considered negligible.</p>
<p>MATHEUS MÜLLER</p>		<p>R 0396/2010-1</p> <p>The Board did not assess the elements '50cl', '50 % vol.', 'ANNO' or '1857' phonetically or conceptually.</p>
<p>MAGNA</p>		<p>R 1328/2005-2</p> <p>The Board described the contested sign in full, but negligible elements such as '70cl' were not included in the comparison.</p>

		<p style="text-align: right;">T-472/08</p> <p>The elements other than 'cachaça'/'pirassununga' and '51', the latter written in white partially within a circle that is itself partially within a broad band running from one side of the sign to the other, are negligible in the overall impression created by those marks (para. 65).</p>
---	---	---

1.6 Relevant territory and relevant public

Similarity must be assessed for the territory in which the earlier mark is protected. The relevant territory must be indicated. Moreover, the perception of the relevant public plays an important role when comparing signs⁴.

Where the earlier mark is a national mark, the relevant criteria must be analysed for the relevant public in that particular EU Member State (or Member States in the case of Benelux trade marks). The perception of similarity may differ from one Member State to another because of differences in pronunciation and/or meaning/understanding.

When the earlier mark is a CTM registration, the analysis must in principle extend to the *whole* EU. However, in situations where there is likelihood of confusion in at least one Member State *and* when justifiable for reasons of economy of procedure (such as to avoid examining specific pronunciations or meanings of marks in several languages), the Office's analysis need not extend to the whole EU but may instead focus on only one *part or parts* where there is a likelihood of confusion.

The unitary character of the Community trade mark means that an earlier Community trade mark can be relied on in opposition proceedings against any application for registration of a Community trade mark that would adversely affect the protection of the first mark, even if only for the perception of consumers in part of the European Union (judgment of 18/09/2008, C-514/06 P, Armacell, § 56-57 and subsequent case-law, inter alia judgment of 18/09/2011, T-460/11, Bürger, EU:T:2012:432, § 52 and the case-law quoted therein).

If the opposition is based on an international registration, the territory for which the basic mark is protected is not to be considered as the relevant territory of the earlier international registration designating or subsequently designating other relevant territories (except if the owner has protection in the whole EU — IR designating or subsequently designating the EU where the same country of the basic registration is covered).

⁴ The Guidelines, Part C, Opposition, Section 2, Double Identity and Likelihood of Confusion, Chapter 3, Relevant Public and Degree of Attention.

2 Identity of Signs

2.1 The concept of identity

As indicated above, a finding of identity between signs will lead to the success of the opposition pursuant to Article 8(1)(a) CTMR if the goods and services are also identical.

The differences between Article 8(1)(a) CTMR and protection in the event of likelihood of confusion, pursuant to Article 8(1)(b) CTMR, must be borne in mind in order to understand the concept of identity and the requirements attached thereto.

Protection pursuant to Article 8(1)(a) CTMR is absolute, because registration of a later identical sign for identical goods or services would compromise the function of the earlier mark as a means of identifying commercial origin. Where absolutely identical signs or marks are registered for identical goods or services, it is impossible to conceive of circumstances in which all likelihood of confusion could be ruled out. There is no need to consider any other factors, such as the degree of attention of the public or the distinctiveness of the earlier trade mark.

However, pursuant to Article 8(1)(b) CTMR, the earlier trade mark is protected against the likelihood of confusion: even if the trade marks differ in some elements, their similarity — in combination with further elements that have to be assessed globally — may lead to the assumption that the relevant goods and services originate from the same or an economically linked undertaking.

Due to the absolute protection conferred by Article 8(1)(a) CTMR, the concept of identity between trade marks must be interpreted strictly. The absolute protection in the case of a CTM application ‘which is identical with the [earlier] trade mark in relation to goods or services which are identical with those for which the trade mark is registered [pursuant to Article 8(1)(a) CTMR] cannot be extended beyond the situations for which it was envisaged, in particular, to those situations which are more specifically protected by [Article 8(1)(b) CTMR]’ (judgment of 20/03/2003, C-291/00, Arthur et Félicie, EU:C:2003:169, § 50-54 in relation to the corresponding provisions of the TM Directive).

2.2 Threshold for a finding of identity

The very definition of identity implies that the two signs should be the same in all respects. There is, therefore, identity between trade marks where the CTM application reproduces, without any modification or addition, all the elements constituting the earlier trade mark.

However, since the perception of identity between the two signs is not always the result of a direct comparison of all the characteristics of the elements compared, insignificant differences between trade marks may go unnoticed by the average consumer.

Therefore, **the CTM application should be considered identical to the earlier trade mark ‘where it reproduces, without any modification or addition, all the elements constituting the trade mark or where, viewed as a whole, it contains differences so insignificant that they may go unnoticed by an average consumer’** (judgment of 20/03/2003, C-291/00, Arthur et Félicie, EU:C:2003:169, § 50-54).

An insignificant difference between two marks is a difference that a reasonably observant consumer will perceive only upon examining the marks side by side. ‘Insignificant’ is not an objective term, and its interpretation depends on the level of complexity of the trade marks being compared. Insignificant differences are those that, because they concern elements that are very small or are lost within a complex mark, cannot be readily detected by the human eye upon observing the trade mark concerned, bearing in mind that the average consumer does not normally indulge in an analytical examination of a trade mark but perceives it in its entirety.

The finding that an element is ‘insignificant’ should be accompanied by sufficient reasoning for its lack of impact on the global perception of the trade mark.

It follows from the definition of identity above that the following conditions have to be met in order for trade marks to be considered identical in accordance with Article 8(1)(a) CTMR:

- **complete identity of the signs taken as a whole.** Partial identity is not sufficient under Article 8(1)(a) CTMR; however, a coincidence in any part of the mark may lead to similarity between the signs and should be addressed when carrying out the examination of Article 8(1)(b) CTMR.

Any additional element is sufficient for concluding that the marks are not identical; it is immaterial whether the added element is a word, a figurative device or a combination of the two.

Consequently, two word marks will not be considered identical if one is contained within the other but is accompanied by further characters (see paragraph 2.4 below) or by words — irrespective of distinctiveness or possible descriptive character.

Earlier sign	Contested sign and comments	Case No
Millenium	MILLENIUM INSURANCE COMPANY LIMITED It was found that ‘the signs at stake were obviously not identical’, even if ‘Insurance company limited’ was descriptive in English for the related services.	R 0696/2011-1
INDIVIDUAL		R 0807/2008-4

- **identity on all levels of comparison.** There must be identity between the signs at all relevant levels of trade mark comparison, that is, visual, phonetic and conceptual. If the trade marks are identical in some aspects (visual, phonetic or conceptual) but not in others, they are not identical overall. In the latter case, they may be similar and, therefore, likelihood of confusion must be examined.

2.3 Identity of word marks

Word marks are identical if both are purely word marks and coincide exactly in the string of letters or numbers. Word marks are marks consisting of letters, numbers and other signs (e.g. ‘+’, ‘@’, ‘!’) reproduced in the standard typeface used by the

respective office. This means that they do not claim any particular figurative element or appearance. Where both marks are registered as word marks, the typeface actually used by the respective office in the official publication (e.g. the Bulletin) is immaterial. Differences in the use of lower or upper case letters are immaterial, even if lower case and upper case letters alternate.

The following word marks are identical:

Earlier sign	Contested sign	Case No
MOMO	MoMo	<u>B 1 802 233</u>
BLUE MOON	Blue Moon	R 0835/2010-1
GLOBAL CAMPUS	Global Campus	R 0719/2008-2
ZEUS	Zeus	R 0760/2007-1
JUMBO	Jumbo	R 0353/2007-2
DOMINO	Domino	R 0523/2008-2
Apetito	APETITO	T-129/09

In general, it should be checked whether the sign has been registered as a word mark. For example, examining only the graphic representation of the trade mark (for instance, in the Madrid System) can be misleading because, depending on the graphic representation of the signs used in the certificates, bulletins, etc., a mark *claimed as a word mark* may include figurative or stylised elements or fonts. In these cases, the claim will prevail over the exact reproduction in the certificate, bulletins, etc.

Marks in non-Latin characters must be considered as word marks in the designated jurisdictions where those characters are officially used (e.g. Cyrillic in the case of a CTM or an IR designating Bulgaria or the EU, in accordance with the indication of category No 28.05 'inscriptions in Cyrillic characters' of the Vienna Classification of figurative elements). The following Cyrillic word marks are identical.

Earlier sign	Contested sign	Case No
ВАСИЛЬКИ	Васильки	B 1 827 537



A difference of just one letter is sufficient for a finding of non-identity. The same applies to a space or a punctuation mark (e.g. hyphen, full stop), since the presence of either may change how the sign is perceived (see the first example below). The following word marks **are not** identical:

Earlier sign	Contested sign	Case No
She , SHE	S-HE	T-391/06
TELIA	teeli	B 13 948
NOVALLOY	NOVALOY	B 29 290
HERBO-FARMA	HERBOFARM	R 1752/2010-1



2.4 Word marks and figurative marks

A **word mark and a figurative mark**, even when both consist of the same word, will not be identical unless the differences go unnoticed by the relevant public.

In the following examples the signs are clearly not identical:

Earlier sign	Contested sign	Case No
	IHotel	T-277/11
	ELCO	R 0803/2008-1
eClear		R 1807/2010-1
BIG BROTHER		R 0932/2010-4

However, the finding that trade marks are not identical can be more difficult if the figurative trade mark is written in normal typeface. Nevertheless, in the following examples the trade marks were found **not to be identical**:





Earlier sign	Contested sign	Case No
	THOMSON	R 0252/2008-1
	Klepper	R 0964/2009-1

2.5 Identity of figurative marks

Two figurative marks are identical when both signs match in all their figurative elements (shape, colours, contrast, shadowing, etc.).

It goes without saying that use of the same word will not suffice for a finding of identity when the figurative element is not the same. The following marks are not identical:

Earlier sign	Contested sign	Case No
		R 0558/2011-1

		R 1440/2010-1
		7078 C

However, since in the following case the difference in the presentation of the letters 'TEP' in italics would go unnoticed by the public, the marks were considered **identical**:



Earlier sign	Contested sign	Case No
		B 2 031 741

2.6 Identity of an earlier black and white (B&W) or greyscale mark with a colour mark application

In the framework of the European Trade Mark and Design Network, the Office and a number of Trade Mark Offices in the European Union have agreed on a common practice with regard to the scope of identity of earlier B&W or greyscale marks with coloured versions of the same sign.



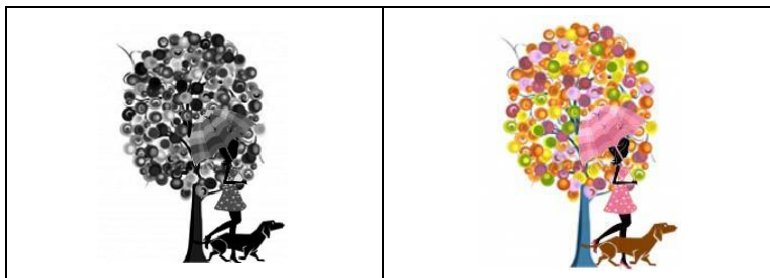

According to this converged practice, the **differences** between an earlier B&W or greyscale mark and a coloured version of the same sign **will normally be noticed** by the average consumer, with the consequence that the marks are not considered identical. It is only under **exceptional circumstances** that the signs will be considered identical, namely where the differences in the colours or in the contrast of shades are so **insignificant** that a reasonably observant consumer will perceive them only upon examining the marks side by side. In other words, for the finding of identity the differences in the colour of the signs in question must be hardly noticeable by the average consumer.

Invented examples of **significant** differences with the consequence of no identity:



Earlier sign	Contested sign
	



Invented examples of **insignificant** differences with the consequence of identity:

Earlier sign	Contested sign
	
	

In relation to the findings above, the issue as to whether a trade mark registered in B&W or greyscale should be considered to cover all colours has also been addressed by the Court in a subsequent judgment (judgment of 09/04/2014, T-623/11, Milanówek cream fudge, EU:T:2014:199):

Earlier sign	Contested sign	Case No
 <p>et al</p>		<p>T-623/11</p>
<p>The Court considered that the fact that ‘the proprietor of a mark may use it in a colour or a combination of colours and obtain for it, as the case may be, protection under the relevant applicable provisions ... does not mean ... that the registration of a mark which does not designate any specific colour covers all colour combinations which are enclosed with the graphic representation’ (para. 39).</p> <p>In this particular case, the Court considered that the Board was right in finding ‘that one difference between the mark applied for and the first and second earlier marks lay in the fact that the mark applied for consisted, in part, of a yellow background with white vertical stripes’ (para. 40).</p>		

3 Similarity of Signs

3.1 Introduction

The similarity of signs depends on the distinctiveness (see paragraph 3.2 below) and dominant character (see paragraph 3.3 below) of their components, which are defined in the opposition decision. In the comparison of marks, the visual, phonetic and conceptual similarity must be assessed by weighing up the coinciding and the differing elements, and by taking into consideration their distinctiveness and dominance (see paragraph 3.4 below) and whether and to what degree these elements coin the overall impression produced by the marks. All these considerations will lead to a conclusion on the degree of similarity in each (visual, phonetic and conceptual) aspect (see paragraph 3.5 below).

3.2 Distinctive elements of the marks

In its judgment of 11/11/1997, C-251/95, Sabèl, EU:C:1997:528, § 23, the Court held that ‘... (the) global appreciation of the visual, aural or conceptual similarity of the marks in question, must be based on the overall impression given by the marks, bearing in mind, in particular, their distinctive and dominant components’. Therefore, the degree of distinctiveness of the various components of composite marks is an important criterion that must be considered within the trade mark comparison.

When assessing the similarity of signs, an analysis of whether the coinciding components are descriptive, or otherwise non-distinctive is carried out in order to calculate the extent to which these coinciding components have a lesser or greater capacity to indicate commercial origin. This recognises that the consumer is more likely to consider that a descriptive, allusive or otherwise weak element of a mark is not being used to identify a particular undertaking, and thus to distinguish goods or services from those of other undertakings.

Consequently, although trade mark proprietors commonly use descriptive, allusive or otherwise weak elements as part of a trade mark to inform consumers about certain characteristics of the relevant goods or services, it may be more difficult to establish that the public may be confused as to origin due to similarities that solely pertain to weak elements.

The distinctiveness of the components of both the earlier **and** of the contested mark must be examined.

It is important to distinguish between the analysis of the distinctive character of (i) the component of a mark and (ii) the earlier mark as a whole. Analysing the components determines whether the signs in conflict coincide in a component that is distinctive (and therefore important) or weak (therefore being of less importance in the trade mark comparison). The analysis of the earlier mark as a whole determines the scope of protection afforded to that mark, which is a separate consideration within the likelihood of confusion, independent from the comparison of the trade marks (dealt with in Chapter 5, Distinctiveness of the Earlier Mark)⁵.

⁵ The Guidelines, Part C, Opposition, Section 2, Double Identity and Likelihood of Confusion, Chapter 5, Distinctiveness of the Earlier Mark.

If either mark consists of one element only, the decision in the part dealing with the comparison of signs will establish whether its distinctiveness is normal or lower than normal. In this case, it cannot be found that a mark lacks distinctiveness. Regarding the earlier mark, this would amount to denying its distinctive character (for details, see paragraph 3.2.3.4 below). As regards the contested sign, this would mean that a new examination on absolute grounds would have to be carried out.

3.2.1 What is a component of a sign?

The Court has not defined what is to be regarded as a ‘component’ or ‘element’ of a sign. It is easy to identify components when a sign is visually divided into different parts (e.g. separate figurative and verbal components). However, the term ‘component’ encompasses more than these visual distinctions. Ultimately, the perception of the sign by the relevant public is decisive and a component exists wherever the relevant public perceives one. For example, the relevant public will often regard one-word signs as being composed of different components, in particular, where one part has a clear and evident meaning while the rest is meaningless or has a different meaning (e.g. in the mark EUROFIRT, ‘Euro’ will be widely understood as referring to Europe whereas ‘Firt’ is meaningless, giving this word mark two components: ‘Euro’ and ‘Firt’). In such cases, the elements of one-word signs could be regarded as ‘components’ in the terminology of the Court.

However, **word marks should not be artificially dissected**. Dissection is not appropriate unless the relevant public will clearly perceive the components in question as separate elements. A case-by-case assessment is required as to whether the division of a sign into components is artificial (e.g. whether splitting the word ‘LIMEON’ for fruit into the components ‘LIME’ and ‘ON’ would be artificial or not).

3.2.2 Examination of distinctiveness

3.2.2.1 What is distinctiveness?

The Court has defined distinctiveness in the following manner:

In determining the distinctive character of a mark and, accordingly, in assessing whether it is highly distinctive, the national court must make an overall assessment of the greater or lesser capacity of the mark to identify the goods or services for which it has been registered as coming from a particular undertaking, and thus to distinguish those goods or services from those of other undertakings (emphasis added).

(Judgment of 22/06/1999, C-342/97, Lloyd Schuhfabrik, EU:C:1999:323, § 22).

Importantly, distinctive character is a matter of degree and, when analysing distinctiveness, a sliding scale applies whereby a component of a sign can lack distinctiveness entirely, be fully distinctive (to a normal degree) or be at any point in-between.

At this point, it must be noted that it is not, in principle, the Office’s practice to recognise a higher than average degree of inherent distinctiveness for individual components of signs. Any higher degree of distinctiveness (enhanced distinctiveness, reputation) is related to actual recognition of the mark by the relevant public, and is

eventually examined only with respect to the earlier mark (see Chapter 5, Distinctiveness of the Earlier Mark). A mark will not have a higher degree of distinctive character just because there is no conceptual link to the relevant goods and services (order of 16/05/2013, C-379/12 P, H/Eich, EU:C:2013:317, § 71).

An element of a sign is **not distinctive** if it is exclusively descriptive of the goods and services themselves or of the characteristics of those goods and services (such as their quality, value, purpose, provenance, etc.) and/or if its use in trade is common for those goods and services. Similarly, an element of a sign that is generic (such as a common shape of a container or a common colour) will also lack distinctiveness.

An element of a sign may be **distinctive to a low degree if it refers to** (but it is not exclusively descriptive of) characteristics of the goods and services. If the allusion to the goods and services is sufficiently imaginative or clever, the mere fact that there is an allusion to characteristics of the goods might not materially affect distinctiveness. For example:

- ‘Billionaire’ for *gaming services* is allusive in a manner that would affect distinctiveness, because it implies for instance that you may become a billionaire.
- ‘Billy O’Naire’, which sounds identical to ‘billionaire’ in English, would be allusive for *gaming services* as a clever word-play on Irish names, in a manner that would not affect distinctiveness in a material way; it would be considered to have a ‘normal’ degree of distinctiveness.

An element of a sign that is neither non-distinctive nor weakly distinctive possesses a **‘normal’ degree of inherent distinctiveness**. This means that the element of a sign in question is fully distinctive, in the sense that its capacity to identify the goods and services covered by the mark as coming from a particular undertaking is not in any way diminished or impaired.

One of the most frequent arguments brought by applicants is that the earlier trade mark or one of its components has a low distinctive character given that there are many trade marks that consist of, or include, the element in question. Where this argument is supported only by the applicant referring to trade mark registrations, the Office takes the view that the existence of several trade mark registrations is not per se particularly conclusive, as it does not necessarily reflect the situation in the market. In other words, on the basis of registered data only, it cannot be assumed that all the trade marks have been effectively used.

It follows that the evidence submitted must demonstrate that consumers have been exposed to widespread use of, and become accustomed to, trade marks that include the element in question in order to prove that the element in question has a low degree of distinctive character.

3.2.2.2 Relevant point in time

The inherent distinctiveness of the components should be assessed at the time of the decision.

Establishing the precise point in time for evaluating distinctiveness is important because the degree of distinctiveness of the marks is not constant, but varies depending on the perception of the public. This perception may change not only due to the nature of the use of the specific mark, but also due to other factors (all these

elements can only be considered from the evidence submitted by the parties). For instance, the public's perception may change where a mark or some component thereof has been used in the meantime in a similar way by various businesses/traders in the relevant market sector. This common use of a sign can erode the uniqueness of a sign and, consequently, its ability to indicate the origin of the goods and services. In this context, it is important to assess carefully whether the situation described exists in all the relevant geographical areas and with regard to all the relevant goods and services.

As an example, due to technological changes in the field of IT, there has been an increased number of instances where components such as 'I' (internet), 'E' (electronic) and 'M' (mobile) are used adjoined to a meaningful word. In the context of electronic communications, they are currently found to be descriptive (decision of 19/04/2004, R 0758/2002-2, ITUNES, § 11), whereas previously they were considered distinctive.

3.2.2.3 Relevant goods and services

The assessment of the **inherent distinctiveness** of the components is carried out only for the goods or services that are identical or similar, that is:

- the earlier mark is assessed with respect to the registered goods and services that are identical or similar to the contested goods and services;
- the contested trade mark is assessed with respect to the contested goods or services that are identical or similar to those of the earlier mark.

3.2.2.4 General principles of examination of distinctiveness

The examination of inherent distinctiveness is carried out in two phases: first, it should be determined whether the relevant public recognises semantic content of the element at issue and, second, whether or not the semantic content perceived is related to and/or commonly used in trade for the identical or similar goods and services.

As regards the **first phase**, that is to say, whether the relevant public recognises a semantic content, this is assessed in the conceptual comparison of signs, which is described in detail in another chapter of these Guidelines⁶.

The inherent distinctiveness of the components of the marks has to be evaluated by taking into account (each of) the relevant geographical area(s) and their different linguistic and cultural backgrounds. As such, the public in some parts of the relevant territory might not understand the descriptive content that a mark may have in other parts. In these cases, the distinctiveness of the mark in one area is not affected by the fact that it may be perceived differently in other areas.

Below is an example of a case where linguistic considerations were vital to the issue of distinctiveness:

⁶ See paragraph 3.4.3 below, Conceptual comparison.

Earlier sign	Contested sign	Case No
FRUTISOL	Solfrutta	T-331/08
<p>G&S: Classes 29, 30 and 32 Territory: EU Assessment of the components 'frut' and 'sol': '... it is necessary to distinguish between the perception by the public in those Member States, such as Italy and Spain, where the elements "sol" and "frut" are generally recognisable and can be understood as alluding to "sun" and "fruit" respectively, and the perception by the public in those Member States, such as Hungary, Finland and Lithuania, where those elements have no such close equivalent in their national languages'. In the first category of Member States, consumers are liable to associate both marks with the notions of 'fruit' and 'sunshine'. There will consequently be a certain level of conceptual similarity between them. In Member States of the second category, consumers will not perceive any conceptual similarity between the signs since they will not attach any particular meaning to the constituent parts of either sign (paras 21-24).</p>		

The **second phase** consists of correlating any meaning that the public perceives in the components with the identical or similar goods and services in dispute. If the relevant public perceives this meaning as descriptive, laudatory or allusive (in a manner that materially affects distinctiveness), etc. for these goods and services, then its distinctiveness will be diminished accordingly. It may be necessary to distinguish between the various goods and services involved because the finding of no or limited distinctiveness might relate to only part of those goods and services.

The criteria applied to examining the inherent distinctiveness of a component of a sign are the same as the relevant principles applied when examining marks on absolute grounds⁷. However, in relative grounds disputes, the question is not merely whether a component is distinctive or not (i.e. whether it reaches the minimum distinctiveness threshold for registration), but also to what degree it is distinctive within the sliding scale previously mentioned. Therefore, for instance, a term that is not descriptive but merely allusive for the goods or services in question might be distinctive enough to pass the absolute grounds test, but still have less than normal distinctiveness for the purposes of relative grounds.







The outcome of the examination of inherent distinctiveness will be one of the following.

- The component has **less than normal or no distinctiveness** because it is descriptive, laudatory of characteristics of identical or similar goods or services or because it is otherwise weak. See the examples below.
- The component has normal distinctiveness because it is neither non-distinctive nor weak for identical or similar goods or services.

As noted in paragraph 2.1 above, word marks consisting of a single word may still contain various components, some of which may be more distinctive than others (see T-331/08, Solfrutta above).



⁷ These are described in the Guidelines, Part B, Examination. See also Objective 2 of the Common Practice on the Impact of Non-Distinctive/Weak Components on Likelihood of Confusion agreed in the Framework of the European Trade Mark and Design Network.

3.2.2.5 Examples of descriptive components



Earlier sign	Contested sign	Case No
BYLY		T-514/08
G&S: Class 3 Territory: EU Assessment of the element 'products': '... the term "products" is not distinctive enough to be taken into consideration by the consumers' (para. 39).		
Earlier sign	Contested sign	Case No
		T-490/08
G&S: Class 36 Territory: EU Assessment of 'CAPITAL MARKETS': 'the relevant public, consisting of consumers who are very attentive, well informed and familiar with basic English financial terminology, will attach little significance to the meaning of the words "capital" and "markets", which are descriptive of those services and which do not enable the commercial origin of the trade marks at issue to be identified' (para. 59).		
Earlier sign	Contested sign	Case No
		R 0834/2009-1
G&S: Classes 3 and 5 Territory: EU Assessment of the earlier right: even though the signs have some similarities, the expression 'NATURAL BRONZE' is descriptive of the purpose of the goods (tanning) for the goods in Class 3 (para. 31).		
Earlier sign	Contested sign	Case No
	CINETAIN	R 1306/2009-4
G&S: Classes 38 and 41 Territory: Spain Assessment of the element 'CINE': The word 'cine' has a descriptive meaning in the sense of 'cinema (film)'. Therefore, this component has only limited relevance in the perception of the signs (para. 36).		
Earlier sign	Contested sign	Case No
	NATURAL BEAUTY FROM WITHIN	R 0991/2010-2
G&S: Classes 3 and 5 Territory: Germany Assessment of the element 'NATURAL BEAUTY': The element 'NATURAL BEAUTY' is a plain and essential indication of the kind and quality of the goods. The German public understands the meaning of these two basic words as well as the combination thereof (paras 31-35).		
Earlier sign	Contested sign	Case No
FORCE-X	FSA K-FORCE	T-558/13

G&S: Classes 9 and 12
 Territory: EU
 Assessment: The word 'force', synonymous with strength and power, can describe one of the characteristics of the goods concerned. Furthermore, for some goods in Class 12, it must be held that that word can also designate one of their purposes. Furthermore, as is apparent from the evidence adduced by the applicant, the word 'force' is commonly used, on the European market, in trade marks in the domain of cycling, thus rendering it banal (paras 38-39).

3.2.2.6 Examples of laudatory components

Earlier sign	Contested sign	Case No
	MAGIC SEAT	T-363/06
<p>G&S: Class 12 Territory: Spain Assessment of the element 'MAGIC': The word 'magic' will be perceived by the relevant public as a simple qualifier for the word 'seat' on account of its resemblance to the Spanish word 'mágico', which is purely laudatory (para. 39).</p>		
Earlier sign	Contested sign	Case No
STAR SNACKS		T-492/08
<p>G&S: Classes 29, 30 and 32 Territory: EU Assessment of the element 'STAR': The word element 'STAR' is laudatory, as it merely constitutes (together with the remaining elements of the signs) a reference to high-quality food products (para. 52).</p>		

3.2.2.7 Examples of allusive components

Earlier sign	Contested sign	Case No
EL COTO		T-332/04
G&S: Classes 33, 35 and 39 Territory: EU Assessment of distinctiveness of the image in the contested CTMA: The figurative element of the mark evokes a vineyard; this component has little distinctive value as regards wines (para. 38).		
Earlier sign	Contested sign	Case No
	WORLDBLINK	T-325/04
G&S: Class 36 Territory: EU Assessment of the element 'LINK': the element 'LiNK' is not immediately descriptive of inter alia 'banking services for the dispensing of cash; funds transfer and payment services; financial information services' (Class 36) covered by the earlier mark, but merely allusive in relation to them.		

3.2.3 Specific cases

3.2.3.1 One-letter components, numerals and short components

The Court, in its judgment of 09/09/2010, C-265/09 P, 'α', held that the distinctiveness of single-letter trade marks must be assessed according to an examination based on the facts, focusing on the goods or services concerned and the **same criteria that apply to other word marks** (paras 33-39). Although that judgment deals with absolute grounds, the Office considers that the principle established by the Court (i.e. that the application of the criterion of distinctiveness must be the same for all marks) also applies in *inter partes* cases when it comes to determining the distinctiveness of single-letter components in trade marks.

The Court, although acknowledging that it may prove more difficult to establish distinctiveness for marks consisting of a single letter than for other word marks, held that these circumstances do not justify laying down specific criteria supplementing or derogating from application of the criterion of distinctiveness as interpreted in the case-law.

In the context of analysis of distinctiveness of components of signs, the Office considers the ruling to mean that, when establishing the distinctiveness of a single letter, being a component of a sign, it is not correct to rely on assumptions such as a priori statements that consumers are not in the habit of perceiving single letters as trade marks or on generic arguments such as that relating to the availability of signs, given the limited number of letters.

The General Court has since stated in a number of cases that a trade mark containing a **single letter** or a single numeral may indeed be inherently distinctive (judgments of 08/05/2012, T-101/11, G, EU:T:2012:223, § 50; 06/10/2011, T-176/10, seven for all mankind, EU:T:2011:577, § 36; 05/11/2013, T-378/12, X, EU:T:2013:574, § 37-51).

In its judgment of 10/05/2011, T-187/10, G, EU:T:2011:202 the General Court dismissed the applicant’s argument that single letters are generally per se devoid of distinctive character and that, therefore, only their graphic representation would be protected (see paras 38-49).

The above considerations apply both to single-letter/numeral trade marks depicted in standard characters (i.e. word marks) and to stylised single-letter/numeral trade marks.

Furthermore, in accordance with the ‘α’ judgment, as regards these components, unless the letter combination itself is descriptive or otherwise related to the goods and services (e.g. ‘S’, ‘M’, ‘XL’ for goods in Class 25), these components are not necessarily limited in their distinctiveness. The same rules apply to numerals.

3.2.3.2 Commonplace and banal elements

There are instances where signs are composed of one (or various) distinctive verbal element(s) and one (or various) figurative element(s) that are perceived by the relevant public as being commonplace or banal. These figurative elements frequently consist of a simple geometrical shape (e.g. frames, labels) or of colours frequently used in the market sector (e.g. red for fire extinguishers, yellow or red or orange for the postal sector depending on the Member State concerned). For this reason, these commonplace and banal elements are considered non-distinctive.

Earlier sign	Contested sign	Case No
ARCO		R 1929/2010-2
<p>G&S: Class 9 Territory: EU Assessment of figurative elements: the verbal elements of the two signs coincide. Even if it is not negligible in terms of its size, the figurative element of the contested CTM is likely to be perceived by consumers essentially as a mere decorative element, and not as an element indicating the commercial origin of the goods (para. 43).</p>		

3.2.3.3 Disclaimers

Pursuant to Article 37 CTMR, the Office may impose a disclaimer if the mark contains an element that is not distinctive and if inclusion of that element would lead to doubts as to the scope of protection. The Office also accepts disclaimers entered voluntarily. Some national trade mark systems also provide for disclaimers.

These disclaimers bind the Office and have a compulsory effect even if upon independent analysis the element might appear distinctive.

The effect of a disclaimer is:



- if the earlier mark contains a disclaimer, that the proprietor is prevented from successfully invoking rights in the disclaimed element. Therefore, similarity between two signs cannot be induced or increased because of coincidence or similarity in the disclaimed element (decision of 06/10/2008, R 0021/2008-4, AUTENTICO JABUGO, § 17, where JABUGO was disclaimed).

- if the earlier figurative mark contains two words and both are disclaimed, that the scope of protection is reduced to the precise manner and sequence in which the two words are combined.

As regards the disclaimers in the contested CTMA, they cannot bind the owner of the earlier mark, that is to say, the applicant cannot unilaterally reduce the scope of protection of the earlier mark (decisions of 11/02/2010, R 0229/2009-2, DOUGHNUT THEATER, § 58; 29/03/2012, R 2499/2010-1, ACETAT Silicon 101E (fig.), § 18-19).

3.2.3.4 Earlier marks consisting of one element that is distinctive to a low degree

If the earlier mark only consists of one element whose distinctiveness is put in question, the Office applies the practice clarified in the judgment of 24/05/2012, C-196/11, F1-LIVE, EU:C:2012:314, namely that in proceedings opposing the registration of a Community trade mark, the validity of earlier trade marks may not be called into question.

Earlier sign	Contested sign	Case No
		<p>R 2306/2012-1</p>
<p>G&S: Classes 29, 30 and 32 Territory: Czech Republic Assessment: 'The Board also notes that the earlier mark "Glanc" is registered in the Czech Republic for the goods in question and, therefore, for the purpose of the present proceedings, it must be deemed to be endowed with at least some degree of distinctive character.'</p>		

3.3 Dominant elements of the marks

It is the Office's practice to restrict the notion of dominant element to the visual impact of the elements of a sign, that is, to use it exclusively to mean '**visually outstanding**'.

For a finding that there is a dominant element within a sign, the sign should have at least two identifiable components⁸. The rules explained above in paragraph 3.2.1, 'What is a component of a sign?', apply accordingly.

The decision must identify which of the components of a sign is the dominant one.

Even though, according to the established case-law of the Court, aspects other than the visual one (such as a possible semantic meaning of part of a one-word sign) may come into play when defining the notion of the dominant element of a sign, it is the practice of the Office to restrict the notion of dominant element to the visual impact of

⁸ In this text the words 'component' and 'element' are used interchangeably.

the elements of a sign, that is, to use it exclusively to mean ‘visually outstanding’ and to leave any other considerations for the overall assessment. As a result, the Office’s practice is that the dominant character of a component of a sign **is mainly determined by its position, size, dimensions and/or use of colours**, to the extent that they affect its visual impact. As stated by the Court:

With regard to the assessment of the dominant character of one or more given components of a complex trade mark, account must be taken, in particular, of the intrinsic qualities of each of those components by comparing them with those of other components. In addition and accessorially, account may be taken of the relative position of the various components within the arrangement of the complex mark.

(Judgment of 23/10/2002, T-6/01, Matratzen, EU:T:2002:261, § 35, confirmed by order of 28/04/2004, C-3/03 P, Matratzen, EU:C:2004:233).

In addition, the Court has held that:

... the weak distinctive character of an element of a complex mark does not necessarily imply that that element cannot constitute a dominant element since, because, in particular, of its position in the sign or its size, it may make an impression on consumers and be remembered by them.

(Judgment of 13/06/2006, T-153/03, Peau de vache, EU:T:2006:157, § 32).

Consequently, the fact that a component of a mark may or may not be considered non-distinctive (or as having a low degree of distinctiveness) has no bearing on the assessment of dominant character.





As a rule of thumb, the following should be considered:

- The assessment of dominant character applies to both the signs under comparison.
- For a finding that there is a dominant component, the sign should have at least two identifiable components.
- Word marks have no dominant elements because by definition they are written in standard typeface. The length of the words or the number of letters is not an issue of dominance but of overall impression⁹.
- Figurative elements may be dominant in signs where word elements are also present.
- Whether or not an element is visually outstanding may be determined in the visual comparison of the signs; if that is the case, it must be consistent with a subsequent evaluation of dominant character.
- Lastly, if it is difficult to decide which of the (at least) two components is dominant, this may be an indication that there is no dominant element or that no

⁹ See the Guidelines, Part C, Opposition, Section 2, Double Identity and Likelihood of Confusion, Chapter 7, Global Assessment.

element is more dominant than the other (which includes cases of co-dominance). The establishment of dominant character implies that one component is visually outstanding compared to the other component(s) in the mark; if that assessment is difficult to make, it is because there is no dominant element.

Examples of cases:

Sign	Dominant component and reasoning	Case No
	<p>RPT: ‘the dominant element of the earlier marks is the acronym RPT, in which the letter “p” predominates’ (para. 33).</p>	T-168/07
	<p>Free: ‘the word “free” dominates the visual impression created by the mark of which it forms part, because it is considerably larger than the other components and, in addition, is much easier to remember and pronounce than the slogan in question’ (para. 39).</p>	T-365/09
	<p>Xtreme: ‘On the visual level, it must be concluded that in the mark applied for, the term “XTREME” occupies a central position. Indeed, the size of its typeface is bigger than that of the other verbal elements, and the word is highlighted with a white outline ... The other verbal components “RIGHT GUARD” and “SPORT”, are written in a much smaller type and are shifted to the right and towards the edge of the sign’ (para. 55).</p>	T-286/03
	<p>GREEN by missako: ‘It must be noted, as a first point, that the representation of the sun has an important place within the mark applied for, in that it is positioned in the centre and covers almost two thirds of the area. Next, the position of the word element “green” is also important within the mark, as it is portrayed in large-typeface, stylised upper case letters in black and takes up about one third of the area. As observed by the Board of Appeal in para. 28 of the contested decision, those two elements thus occupy the major portion of the mark applied for and are, therefore, striking in the overall impression of the mark. Lastly, as regards the word element “by missako”, the Board of Appeal correctly held, in para. 28 of the contested decision, that those words were almost illegible because of their size and that the handwriting made them difficult to decipher. It follows, first, that the dominant nature of the word “green” and of the representation of the sun are thereby further reinforced and, secondly, that the word element “by missako” is negligible in nature’ (paras 37-39).</p>	T-162/08
	<p>BÜRGER: The dominant element of the mark applied for is undeniably the word element in upper case letters that stands out, simply because of its position and the very large size of its lettering, from all the other elements that make up the label (para. 38).</p>	T-460/11

3.4 Comparison of signs

In the following paragraphs the application of the principles explained above will be explained with regard to the visual (paragraph 3.4.1), phonetic (paragraph 3.4.2) and conceptual comparison (paragraphs 3.4.3 and 3.4.4). Thereafter, the impact of distinctiveness and dominant character of the common and differing elements (paragraph 3.4.5) and other principles to be taken into account in the comparison of signs (paragraph 3.4.6) will be presented.

3.4.1 Visual comparison

Within the visual comparison it is important to note first that the public perceives word elements of a mark in a different way than other elements. Word elements can be read or associated with a sequence of letters. Other elements are just assessed as to their graphical or figurative characteristics. In the following, the principles of visual comparison will be presented depending on the type of trade marks involved.

3.4.1.1 Word mark v word mark

When at least one word mark is involved, the word as such is protected, not its written form.

According to the case-law, a word mark is a mark consisting entirely of letters, of words or of associations of words, written in printed characters in normal font, without any specific graphic element (judgments of 20/04/2005, T-211/03, Faber, EU:T:2005:135, § 33; 13/02/2007, T-353/04, Curon, EU:T:2007:47, § 74). The protection offered by the registration of a word mark applies to the word stated in the application for registration and not to the individual graphic or stylistic characteristics which that mark might possess (judgment of 22/05/2008, T-254/06, RadioCom, EU:T:2008:165, § 43).

Therefore, it is irrelevant whether the word mark is depicted in lower or upper case letters:

Earlier sign	Contested sign	Case No
BABIDU	babilu	T-66/11 (§ 57)
BALLYMANOR	BallyM	R 0391/2010-1

For word marks, the visual comparison is based on an analysis of the number and sequence of the letters/characters, the position of the coinciding letters/characters, the number of words and the structure of the signs (e.g. whether word elements are separated or hyphenated).

However, the average consumer normally perceives a sign as a whole and does not proceed to analyse its various details. Therefore, small differences in the (number of) letters are often not sufficient to exclude a finding of visual similarity, particularly when the signs have a common structure.

In the following cases the marks were held to be visually similar:

Earlier sign	Contested sign	Case No (level of similarity)
MEDINETTE	MESILETTE	T-342/10 (average)
FORTIS	FORIS	R 0049/2002-4 (high)
ARTEX	ALREX	T-154/03 (very high)
MARILA	MARILAN	R 0799/2010-1 (high)
EPILEX	E-PLEX	T-161/10 (average)
CHALOU	CHABOU	T-323/10 (high)

The following word marks are visually dissimilar:

Earlier sign	Contested sign	Case No
CAPOL	ARCOL	C-193/09 P and T-402/07

The Board held that although those marks shared the letter 'a' and the ending 'ol', they 'clearly differ[ed]' visually. The General Court agreed. It held that **the same number of letters in two marks is not, as such, of any particular significance for the relevant public**, even for a specialised public. Since the alphabet is made up of a limited number of letters, which, moreover, are not all used with the same frequency, it is inevitable that many words will have the same number of letters and even share some of them, but they cannot, for that reason alone, be regarded as visually similar. In addition, the public is not, in general, aware of the exact number of letters in a word mark and, consequently, will not notice, in the majority of cases, that two conflicting marks have the same number of letters (paras 81-82). The Court held that **what matters in the assessment of the visual similarity of two word marks is the presence, in each of them, of several letters in the same order** (para. 83). The ending 'ol' of the marks at issue constituted a common element of the marks but comes at the end and is preceded by completely different groups of letters (respectively, 'arc' and 'cap'), so the Board of Appeal correctly concluded that that this commonality does not render the marks visually similar (para. 83). The Court of Justice upheld this assessment from a visual perspective (para. 74).



3.4.1.2 Word mark v figurative mark with word elements

When figurative marks with word elements and word marks are compared visually, what matters is whether the signs share a significant number of letters in the same position and whether the word element in the figurative sign is highly stylised. Similarity may be found despite the fact that the letters are graphically portrayed in different typefaces, in italics or bold, in upper or lower case or in colour.



In principle, when the same letters are depicted in the same sequence, any variation in stylisation has to be high in order to find visual dissimilarity.

The following marks were considered visually **similar** because there was no high variation in the stylisation of the word elements in the figurative marks and the word element was easily recognisable and legible:

Earlier sign	Contested sign	Case No (level of similarity)
VITAFIT		T-552/10 (average)

COTO DE IMAZ		R 0409/2009-1 (high)
vendus sales & communication group		R 0994/2009-4 (high)





However, where the word in the figurative mark is highly stylised, the marks should be found visually **dissimilar**, as in the following examples:

Earlier sign	Contested sign	Case No
NEFF		R 1242/2009-2
	NODUS	R 1108/2006-4





3.4.1.3 Purely figurative v purely figurative signs

When comparing signs in conflict in terms of their **purely figurative elements**, the Office considers the latter as images: if they match in one, separately recognisable, element or have the same or a similar contour, it is likely that some visual similarity will be found.

The following purely figurative signs were found to be visually **similar**.







Earlier sign	Contested sign	Case No (level of similarity)
		T-379/08 (average)
		B 1 157 769 (medium)

The following purely figurative signs were deemed to be visually **dissimilar**:

Earlier sign	Contested sign	Case No
		B 1 572 059
		T-502/11

3.4.1.4 Stylised mark v stylised mark

When comparing signs in terms of their **word elements**, the Office considers signs similar insofar as they share a significant number of letters in the same position and when they are not highly stylised or when they are stylised in the same or a similar manner. Similarity may be found despite the fact that the letters are graphically portrayed in different typefaces, in italics or bold, in upper or lower case or in colour (judgments of 18/06/2009, T-418/07, LiBRO, EU:T:2009:208; 15/11/2011, T-434/10, Alpine Pro Sportswear & Equipment, EU:T:2011:663, appeal C-42/12 P, Alpine Pro Sportswear & Equipment, EU:C:2012:765 dismissed). In the following examples, the marks were considered visually **similar** because they share some words or sequences of letters and the typeface was deemed not to be highly stylised:

Earlier sign	Contested sign	Case No (level of similarity)
		R 1454/2005-4 confirmed by T-418/07 (average similarity)
		R 1148/2008 (high)
		T-383/12 (high)

In the following examples, however, the marks were considered visually **dissimilar** in spite of the fact that they shared some words and/or letters and/or figurative devices, because the shared letters are highly stylised, placed differently and/or there are additional figurative devices:

Earlier sign	Contested sign	Case No
		T-390/03
		T-106/06
		R 1109/2008-1
		R 0111/2010-4

When comparing figurative signs visually, it is still possible to find visual similarity when the figurative elements are different (i.e. they do not match or have the same or similar contour) and the word elements are different. Similarity will be found when the overall stylisation, structure and colour combination render the signs visually similar overall.





The following example illustrates how similar structure, stylisation and colour combination render signs visually similar:

Earlier sign	Contested sign	Case No (level of similarity)
		B 1 220 724 (high)

3.4.1.5 Word/figurative sign v figurative sign

A coincidence in a figurative element that is visually perceived in an identical or similar way may lead to a visual similarity.

The following examples are cases where there are visual similarities because of matching figurative elements:

Earlier sign	Contested sign	Case No (level of similarity)
		T-81/03, T-82/03 and T-103/03 (significant)
(i) 	(ii) 	R 0144/2010-2 (low)

In the following example the figurative elements were different and the signs were considered visually **dissimilar**:

Earlier sign	Contested sign	Case No
		B 134 900 The marks were considered visually dissimilar

3.4.1.6 Signs consisting of a single letter

As explained previously in this chapter (see paragraph 3.2.3.1 above), in cases of conflicting signs containing the same single letter, the visual comparison is normally of decisive importance, these signs usually being phonetically and conceptually identical.



The fact that the conflicting signs comprise the same single letter can lead to a finding of visual similarity between them, depending on the particular way the letters are depicted.

In the following examples, the signs were found to be visually similar **to a high or medium degree**.

Earlier sign	Contested sign	Case No
		T-115/02

<p>G&S: Classes 9, 16, 25, 35, 41 Territory: EU Assessment: As regards the visual similarity of the conflicting signs, the Board of Appeal rightly considered that both marks in question include as a dominant element the lower-case white letter 'a', of a commonplace typeface, on a black background. That dominant element makes an immediate impression and is remembered. Conversely, the graphic differences between the trade marks in question — namely the shape of the background (oval for the trade mark applied for and square for the earlier trade mark), the position of the letter on that background (in the centre in the case of the trade mark applied for and in the lower right-hand corner in the case of the earlier trade mark), the thickness of the line used to represent that letter (the trade mark applied for uses a slightly broader line than that used in the earlier trade mark) and the calligraphic details of the letters of the respective marks — are minor and do not constitute elements that will be remembered by the relevant public as effective distinguishing features. Consequently, the conflicting signs are very similar from the visual point of view.</p>		
Earlier sign	Contested sign	Case No
A		R 1508/2010-2
<p>G&S: Classes 9, 18, 24, 25, 28 Territory: Germany Assessment: The Board found the signs visually similar to a medium degree.</p>		





In the following cases, the signs were found to be visually similar **to a low degree** (that resulted, depending on a particular case, both in likelihood of confusion and no likelihood of confusion).

Earlier sign	Contested sign	Case No (level of similarity)
(i)  (ii) 	 <small>© Line</small>	T-187/10
<p>G&S: Classes 9, 18, 25 Territory: EU, Italy Assessment: The signs were found to be similar to a low degree from a visual point of view (likelihood of confusion).</p>		

Earlier sign	Contested sign	Case No (level of similarity)
A		T-174/10 (appeal dismissed C-611/11 P)
<p>G&S: Classes 18, 25 Territory: Germany Assessment: On the basis of the particular graphic design of the contested trade mark the Court only found a low degree of visual and conceptual similarity (para. 31). A phonetic comparison was not possible, as it was found that the public would most likely not pronounce the contested trade mark given the particular graphic design (para. 32). Please note that the outcome in this case was that of no likelihood of confusion, although the Court found low visual similarity between the signs — no likelihood of confusion.</p>		

Earlier sign	Contested sign	Case No (level of similarity)
F		R 1418/2006-2
<p>G&S: Class 25 Territory: EU Assessment: Visually, the earlier mark is an upper case letter 'F' written in a standard typeface, whereas the contested mark is a stylised letter 'F', in which the horizontal line is embellished with a distinctive drawing that amounts to a relevant visual difference. The outcome of this case was that of no likelihood confusion.</p>		

Finally, in the examples below the signs were found to be **visually dissimilar** due to the different stylisations or graphic elements of the single-letter signs. The final outcomes of these cases were those of no likelihood of confusion.

Earlier sign	Contested sign	Case No
		R 1655/2006-4
<p>G&S: Class 25 Territory: Spain Assessment: Even though the marks share the presence of the letter 'm', they cannot be considered visually similar since the overall visual impression that each mark makes on the relevant public is clearly distinct. The CTM applied for is a complex graphic device that includes a black lowercase letter 'm' and in addition, other significant figurative elements, namely a bold curved dark line placed above a background circle in which the letter 'm' is almost included. These additional elements are of particular importance since the heavy bold line echoes the form of the background circle and the dark shade of the letter 'm', which is placed over the background. In the earlier mark, the letter 'm' appears in outline font with a characteristic inclination to the right and an uneven height so that the right-hand size of the letter is lower. Consequently, these dissimilarities between the signs are sufficient for it to be held that they do not give the consumer the same visual impression (para. 18).</p>		
Earlier sign	Contested sign	Case No
		R 576/2010-2 (confirmed by T-593/10)
<p>G&S: Classes 25, 41, 43 Territory: Germany Assessment: Due to the different colours, figurative element and stylisation, the marks were found to be visually dissimilar. Visually, the earlier mark can be perceived as a boomerang, accompanied by the letter 'B', which is the first letter of 'boomerang'.</p>		





It should be pointed out that the verbal representation of 'one-letter/one-digit sign' is not to be considered equivalent to the sign (e.g. 'ONE' is not equal to '1' or 'EM' to 'M'). Therefore, the aforementioned arguments are not directly applicable to such cases.

Finally, it must be noted that the above considerations also apply to signs consisting of single numbers.

3.4.1.7 Three-dimensional marks

When comparing three-dimensional and two-dimensional signs, the same basic principles as for two-dimensional marks are to be applied. Although the comparative rarity of the three-dimensional sign will usually particularly affect the visual impact of the sign, this must be considered in relation to the overall impression.

In contrast, there is a low degree of visual **similarity** between the following marks:

Earlier sign	Contested sign	Case No (level of similarity)
		R 0806/2009-4, para. 19 (low)
		T-24/08 (low)

The following marks are visually **dissimilar**:

Earlier sign	Contested sign	Case No
		R 0806/2009-4, para. 34

3.4.2 Phonetic comparison

When the opposition is based on earlier signs that enjoy protection in different EU Member States, in principle, account must be taken of all the different pronunciations of the signs by the relevant public in all official languages of those Member States. Local accents are not taken into account. Nevertheless, as already mentioned, when the

earlier mark is a CTM registration, the analysis must in principle extend to the *whole* EU. However, where there is a likelihood of confusion for at least one Member State *and* it is justifiable for reasons of economy of procedure (such as to avoid examining specific pronunciations or meanings of marks in several languages), the Office's analysis need not extend to the whole EU but may instead focus on only a *part or parts* where there is a likelihood of confusion.



The overall phonetic impression produced by a sign is particularly influenced by the number and sequence of its syllables. The common rhythm and intonation of signs play an important role in how signs are perceived phonetically. The Collins English Dictionary defines 'rhythm' as 'the arrangement of words into a more or less regular sequence of stressed and unstressed or long and short syllables'. 'Intonation' is defined as 'the sound pattern of phrases and sentences produced by pitch variation in the voice'.

Therefore, the key elements for determining the overall phonetic impression of a trade mark are the syllables and their particular sequence and stress. The assessment of common syllables is particularly important when comparing marks phonetically, as a similar overall phonetic impression will be determined mostly by those common syllables and their identical or similar combination.

The following are examples of phonetically **dissimilar** marks:

Earlier sign	Contested sign	Relevant territory	Case No
CLENOSAN	ALEOSAN	ES	R 1669/2010-2
GULAS	MARGULIÑAS	ES	R 1462/2010-2

The following are examples of phonetically similar/identical marks:

Earlier sign	Contested sign	Relevant territory	Case No (level of similarity)
CAMEA	BALEA	EU	T-195/13 (low similarity)
		PT: the part of the relevant public that has some knowledge of the English language will read and pronounce the earlier mark in the same way as the mark applied for insofar as the latter uses the English word 'forever' (para. 70). The marks at issue share the same ending 'ever'; the Board of Appeal did not err in finding that those marks were phonetically similar to an average degree for the part of the relevant public with no knowledge of the	T-528/11 (identity/average similarity)





		English language (para. 72).	
FEMARA		EU	R 0722/2008-4 (above average)
	FOR US	BX	R 0166/2010-1 (identity)
		DE	R 1071/2009-1 similar to a low degree

3.4.2.1 Signs and elements in signs that must be assessed



A figurative mark without word elements cannot, by definition, be pronounced. At the very most, its visual or conceptual content can be described orally (judgment of 07/02/2012, T-424/10, *Eléphants dans un rectangle*, EU:T:2012:58, § 46).

In other words, purely figurative marks (i.e. those not containing any word element) are not subject to a phonetic assessment. The ‘meaning’ that the image evokes or its ‘description’ will be assessed visually and conceptually.

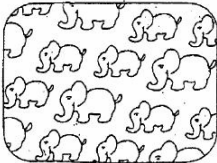
The following are examples where no phonetic comparison could be made because the marks are purely figurative:

Earlier sign	Contested sign	Case No
		R 0131/2010-4
		R 0403/2009-2
		T-424/10

Furthermore, when one of the signs has elements that can be read and the other has only figurative elements not subject to a phonetic assessment, the outcome should be that no phonetic comparison can be made. For example:

Earlier sign	Contested sign	Case No
		R 0144/2010-2

With regard to the pronunciation of figurative elements reminiscent of a letter, it should be noted that the relevant public will tend to read these figurative elements only when they are linked to or form part of a word known to the relevant public, such as in the following examples:

Earlier sign	Contested sign	Case No
OLI SONE		B 1 269 549
ROCK		T-146/08

In the following case, however, the figurative element will not be recognised and read as 'X' and the contested sign read as 'be light':

Earlier sign	Contested sign	Case No
BECKs		T-172/12

Finally, while words, letters and numbers must always be assessed phonetically, some symbols and abbreviations give rise to uncertainty.

For example, the logogram '&' (ampersand) will generally be read and pronounced and, therefore, should be included in the phonetic comparison. However, the pronunciation of a given symbol may differ where different languages are concerned.

Earlier sign	Contested sign	Case No
	DNG	R 0160/2010-2 The ampersand '&' will be pronounced in most European Union languages and is recognised as the corresponding translation of the conjunction 'and'.

The same goes for the typographic character @, which in principle will be pronounced. Obviously, the pronunciation of a given symbol may differ where different languages are concerned.

Earlier sign	Contested sign	Case No
	VODAFONE AT HOME	R 138/2010-2 @ will be pronounced as 'at' or 'arobase' in the Benelux (para. 21).



In the above case, it cannot be denied that a part of the relevant public — in particular English speakers — would read the 'at' symbol and thus pronounce the trade mark as 'at home'. This possibility must, therefore, be taken into consideration, together with other possibilities such as 'a home' or simply 'home'. Naturally, in other languages the symbol may be read in a different way (for example 'arroba' in Spanish and Portuguese).

However, compare this with:

Earlier sign	Contested sign	Case No
		R 0719/2010-1 (T-220/11 dismissed, C-524/12 P dismissed) The @ will be perceived as the letter 'a' by (at least) the EN public (para. 25).





The plus (+) and minus/hyphen (-) symbols may also be pronounced by the relevant public, depending on the circumstances. The minus symbol may be pronounced when used in combination with a number, for example '-1', but it will not be pronounced if used as a hyphen (as in 'G-Star').

In the following examples, the symbol '+' in the contested CTMA would be pronounced as 'plus':

Earlier sign	Contested sign	Case No
AirPlus International		T-321/07 (C-216/10 P dismissed)
		T-400/06

Currency symbols (€, \$, £, etc.), too, may be pronounced when the relevant mark is pronounced. As an example (fictional), in the United Kingdom the sign '£ 20' would be pronounced as '20 pounds'. Therefore, the signs '£ 20', '20 pounds' and 'twenty pounds' are phonetically identical.

However, sometimes the way in which symbols — or letters — are used makes it unrealistic to assume that they will be read and pronounced, for example, when in a figurative mark a symbol is repeated in order to create a pattern or is highly distorted or otherwise not clearly legible. This is illustrated by the following examples:

Mark	Explanation
	<p style="text-align: center;">T-593/10</p> <p>In this figurative mark, the letter 'B' can be read. The mark must, therefore, be assessed phonetically.</p>
	<p style="text-align: center;">T-593/10</p> <p>In this figurative mark the letter 'B' is so highly distorted that the Court found that for part of the public it is difficult to clearly identify if it is indeed the letter 'b' or the figure '8'.</p>
	<p style="text-align: center;">R 1779/2010-4</p> <p>It is very difficult to determine the pronunciation of the sign. An aural comparison may, therefore, lead to very different results, ranging from identity to dissimilarity.</p>
	<p style="text-align: center;">B 1 127 416</p> <p>In this figurative mark the letter 'H' can be read and, therefore, must be assessed phonetically.</p>
	<p style="text-align: center;">B 1 127 416</p> <p>In this sign, the pattern makes it unlikely that consumers will read an 'H' (or rather several 'H's). This mark cannot be assessed phonetically.</p>

	<p style="text-align: center;">T-282/12</p> <p>The Court held that, although hardly legible at first sight, the words 'FREE' and 'STYLE' in both of the signs are pronounced identically regardless of the language of the public.</p>
---	--

In summary, whether or not a given symbol/letter is pronounceable depends on the type of character in question, how it is depicted, and how it is combined with other elements of the sign.

3.4.2.2 Identical/similar sounds in different order

Where the opposing trade marks are formed of syllables or words that are identical or highly similar but in a different order, so that if just one of the syllables or words were rearranged the signs would be identical or highly similar phonetically, the conclusion should be that the signs are phonetically similar.

For example:

Earlier sign	Contested sign	Case No (level of similarity)
VITS4KIDS	Kids Vits	T-484/08 (C-84/10 P dismissed) (significant similarity)
		T-67/08 (high)

3.4.2.3 Signs consisting of or including foreign or invented words

When a sign contains foreign words, it should be assumed, in principle, that the relevant public is unfamiliar with how foreign native speakers pronounce their own language. Accordingly, the public will tend to pronounce a foreign word in accordance with the phonetic rules of their own language.

Earlier sign	Contested sign	Case No
LIDL	LIFEL	R 0410/2010-1 The first two letters and the last one are the same in both marks. Aurally, the similarity is even stronger because LIDL will often be pronounced as if spelt LIDEL. For phonological reasons, 'D' and 'L' are nearly impossible to pronounce in most languages without inserting a vowel between them. Therefore, the marks would be pronounced LIFEL and LIDEL in languages like Spanish, Italian, German and French.
KAN-OPHTAL PAN-OPHTAL	BAÑOFTAL	T-346/09 The relevant territory is Germany. The Court found a phonetic

		similarity. The German consumer will probably pronounce the letters 'N' and 'Ñ' in the same way. Moreover, the letters 'P' and 'B' are pronounced with both lips and their sound can be confused if they are accompanied by the same vowel; the signs PAN-OPHTAL and BAÑOFTAL are aurally very similar.
GLANZ	GLÄNSA	T-88/10 The GC concluded that the umlaut would not alter the overall phonetic impression for EN, FR and ES speakers, since the languages in question do not have the letter 'ä' (para. 40).

However, this will not be the case when the relevant public is familiar with a word, for example in the following scenarios.

- When it is an established fact that a foreign language is known by the relevant public. For example, the Court has already confirmed that there is at least a basic understanding of the English language by the general public in the Scandinavian countries, the Netherlands and Finland (judgment of 26/11/2008, T-435/07, New Look, EU:T:2008:534, § 23).
- When certain terminology is clearly known by the relevant public for certain classes of goods and/or services. For example, IT professionals and scientists are generally considered to be more familiar with the use of technical and basic English vocabulary than the average consumer, irrespective of territory (judgments of 27/11/2007, T-434/05, Activy Media Gateway, EU:T:2007:359, § 38 and 48 for the IT field (C-57/08 P dismissed); 09/03/2012, T-207/11, Isense, EU:T:2012:121, § 21-22 for German professionals in the medical field).
- When very basic words will be understood in all Member States, such as the English words 'baby', 'love', 'one', 'surf', the Italian word 'pizza', which has also entered the English language, etc.

Earlier mark	Contested sign	Case No
Babylove Baby Love		R 0883/2010-2

- Finally, when any one of the parties provides compelling evidence that a word is known by a significant portion of the relevant public.

Where a significant part of the relevant public pronounces the foreign word correctly, but another significant part applies the rules of their mother tongue, any assessment of phonetic similarity should mention both pronunciations and provide reasoning. For example:

Earlier sign	Contested sign	Case No
WRITE	RIGHT	(example only) English: highly similar aurally



		Spanish: dissimilar aurally
	ZIRH	T-355/02 (appeal C-206/04 P dismissed.) Similar in English-speaking countries and Spain.

As regards **invented or fanciful words** (words that do not correspond to any existing word in the EU), the relevant consumer might pronounce them not only as they would sound according to the rules of pronunciation of their mother tongue but also as they are written.

Earlier sign	Contested sign	Case No
BAMIX	KMIX	T-444/10 The GC noted that the word element 'kmix' does not correspond to any existing word in the European Union and that it may be pronounced by part of the relevant public as it is written, as a single syllable. However, it also considered it possible that the mark applied for would be pronounced as a two-syllable word, namely 'ka' and 'mix'. In certain languages of the European Union (in particular French and German), the letter 'k' is pronounced as 'ka' and the pronunciation 'km' is not usual (para. 32).

3.4.2.4 Single letter signs

Marks consisting of a single letter can be compared phonetically. The following marks are phonetically identical insofar as they both reproduce the letter 'A':

Earlier mark	Contested sign	Case No
		T-115/02

3.4.3 Conceptual comparison: practical criteria

Two signs are identical or similar conceptually when they are perceived as having the same or analogous semantic content (judgment of 11/11/1997, C-251/95, Sabèl, EU:C:1997:528, § 24). The 'semantic content' of a mark is what it means, what it evokes or, when it is an image or shape, what it represents. In this text the expressions 'semantic content' and 'concept' will be used indiscriminately.

If a mark consists of various elements (for example, a word and a figurative element) the concept of each of the elements must be defined. However, if the mark is a meaningful expression (made up of two or more words), what matters is the meaning of the expression as a whole and not of each of the words in isolation.

Not every concept has to be defined: only those concepts likely to be known by the relevant public, as defined by the relevant territory, matter. For example, if the relevant territory is Spain, the fact that the word has a meaning in Polish is normally irrelevant.

As a rule, the conceptual comparison is not influenced by the relevant goods and services. However, if a term has many meanings, one of which is of particular significance to the relevant goods and services, the conceptual comparison may focus on this meaning. In any event, what matters is how the term is perceived by the relevant public. A link between the goods and services and what the sign means, evokes or represents must not be forced or artificially constructed. For example, if the relevant goods relate to *lighting* and the sign is or contains the element 'LED', 'light-emitting diode' is one of the various possible meanings of 'LED' Therefore, the conceptual comparison may focus on this meaning.

3.4.3.1 The semantic content of words

When the mark consists of or contains a word, the first step for an examiner is to look up the explanation of that word in dictionaries and/or encyclopaedias in the language(s) of the relevant territory. If the word is in the dictionary/encyclopaedia, the described meaning will be its semantic content.

As a starting point, it should be noted that the relevant public in the various Member States of the EU mainly speak the languages predominant in their respective territories (judgment of 23/10/2002, T-6/01, Matratzen, EU:T:2002:261, § 27). These languages are normally the official languages of the relevant territory.

Earlier mark	Contested sign	Case No
HALLOUMI	HELLIM	T-534/10
<p>'Hellim' is the Turkish translation of 'Halloumi' (Greek) (a type of cheese). The relevant territory was Cyprus. The Court held that while Turkish is not an official language of the EU, it is one of the official languages of the Republic of Cyprus. Therefore, Turkish is understood and spoken by part of the population of Cyprus (para. 38). Therefore, the Court found that the average consumer in Cyprus, where both Greek and Turkish are official languages, will understand that the words HALLOUMI or HELLIM both refer to the same speciality cheese from Cyprus. Consequently, there is some conceptual similarity between these words (para. 41).</p>		



However, the Court has made equally clear that this rule only concerns the primary linguistic understanding of the public in those territories. This is not an inflexible rule. The relevant public should not automatically be considered as having as its mother tongue the language that is predominant in the Member State concerned, or to have no particular knowledge of other languages (order of 03/062009, C-394/08 P, Zipcar, EU:C:2009:334, § 51).

For instance, in the following scenarios, languages other than the predominant one are to be taken into account:

- When the word in another language is very close to the equivalent word in the official language of the relevant territory. For example, the English word 'bicycle' will be understood in Spain because it is very close to the Spanish equivalent word, 'bicicleta';

- When the word in a foreign language is commonly used in the relevant territory. For example, the Spanish word 'bravo' is commonly used as a term denoting praise, in the sense of 'well done' in Germany.
- When it is known that the relevant public is familiar with a foreign language. For example, the Court has already confirmed that the general public, in the Scandinavian countries, the Netherlands and Finland, has at least a basic understanding of the English language (judgment of 26/11/2008, T-435/07, New Look, EU:T:2008:534, § 23).
- When it is known that the relevant public is familiar with a certain language for certain classes of goods and/or services. For example, English IT terms are normally understood by the relevant public for IT goods, irrespective of territory.
- Very basic words, which will be understood in all Member States because they have become internationally used, such as 'baby', 'love', 'one', 'surf', the Italian word 'pizza', which has also entered the English language, etc.
- Finally, when any one of the parties provides evidence that a word is known by a relevant portion of the relevant public.

The following are **examples** of concepts behind words:

Mark	Territory	Concept	Case No
Mirto	ES	[in EN: myrtle] in Spanish describes a shrub of the family Myrtaceae, two to three metres high.	T-427/07
Peer	EN	Lord	T-30/09
Storm	EN	Bad weather	T-30/09
 --- STAR SNACKS	EU	The terms 'star snacks' and 'star foods' will be understood as referring to quality food not only by English speakers, but also by most of the relevant public.	T-492/08 (Star foods I) T-333/11 (Star Foods II)
 - 	EU	There is some degree of conceptual similarity, based on 'Mc' and the words 'baby' and 'kids' that both refer to children (para. 42).	T-466/09

As shown in some of the examples above, it is not always necessary to give a complete dictionary definition of what a word means. It is sufficient to use a synonym, such as Peer=Lord or Storm=Bad weather.

Additionally, when part of the public will perceive the concept while another part either will not or will perceive a different meaning, a distinction should be made accordingly.

When the mark conveys a **meaningful expression**, the meaning of the expression as a whole, as long as it is understood as such by the relevant public, and not that of the individual words, is the one that is relevant for the conceptual comparison (however, note the exception below concerning expressions in foreign languages). Fictional example: 'KING'S DOMAIN' v 'KING SIZE'.

Incorrect assessment: KING means 'a male sovereign', 'DOMAIN' means 'a territory over which rule or control is exercised' and 'SIZE' means 'the physical dimensions, proportions, magnitude, or extent of an object'. The marks are conceptually similar insofar as they share the notion of 'king'.

Correct assessment: 'KING'S DOMAIN' means 'a territory under the control of a king'; 'KING SIZE' means 'larger or longer than the usual or standard size'. The marks are conceptually dissimilar even though they share the word 'KING'.

This is illustrated by the following examples where the marks were found to be conceptually dissimilar:

Earlier sign	Contested sign	Case No
MOUNTAIN BIKER	MOUNTAIN	B 1 950
Goldband	GoldGips	R 0975/2009-4
ALTA FIDELIDAD	ALTA	B 112 369

The abovementioned rule on meaningful expression has the following **exception**: when signs are in a foreign language, a significant part of the relevant public may have only a limited command of the relevant foreign language and, therefore, might not be able to distinguish the difference in meaning between two expressions. In these instances it may be that the meaning of an expression as such is not perceived; only the meanings of the individual elements. This may, therefore, lead to a finding of similarity insofar as the public understands only the common part. In the example above, if it is found that (part of the) public will understand only KING, the finding should be that the signs are conceptually similar.

Earlier mark	Contested sign	Case No
ICEBERG	ICEBREAKER	T-112/09
<p>The GC considered that 'icebreaker' would be understood only by that part of the Italian public with command of the English language. However, 'iceberg' is a common word with an immediately obvious meaning to the relevant public. Therefore the earlier mark ICEBERG will have a clear meaning for the Italian public, whereas the mark applied for ICEBREAKER would be devoid of any clear meaning for that public.</p> <p>The GC further indicated that the marks at issue have the prefix 'ice' in common. The GC considered that this is a basic English word, understandable for most of the relevant public. It concluded that since the prefix 'ice' had a certain evocative force, it must be regarded as limiting the conceptual difference between the marks at issue, acting as a 'semantic bridge' (paras 41-42).</p>		

Similar considerations apply to expressions that include a combination of technical words understood by only part of the relevant public (e.g. Latin words, words belonging to highly specialised language) and commonly used words. In these cases, it may be

that only the meaning of the commonly used words is perceived, and not the meaning of the expression as such.

3.4.3.2 The semantic content of parts of words

In this regard, the Court has held that, although the average consumer normally perceives a mark as a whole and does not proceed to analyse its various details, the fact remains that, when perceiving a word sign, they will break it down into elements which, for them, suggest a specific meaning or which resemble words known to them (judgment of 13/02/2007, T-256/04, *Respicur*, EU:T:2007:46, § 57).

Consequently, while the rule is that marks are perceived as a whole, the exception to the rule is that, under certain circumstances, consumers could break them down into smaller parts. Since this is an exception, it has to be applied restrictively.

It will be applied in the following cases:

- when the sign itself is broken down visually into various parts (e.g. through the use of upper case letters, as in *AirPlus*);
- when all the parts suggest a concrete meaning known to the relevant public (e.g. *Ecoblue*); or
- when only one part has a clear meaning (e.g. *Dermaclin*).

Examples of signs visually broken down:

Sign	Territory	Concept	Case No
VITS4KIDS	EU	The mark contains VITS (allusive of 'vitamins') and KIDS.	T-484/08
	EU	AGRO: reference to agriculture HUN: reference to Hungary UNI: reference to universal or union.	T-423/08
RNAiFect	EU	The relevant public, particularly the specialist public, will perceive the first three letters as a reference to the English abbreviation for ribonucleic acid.	T-80/08
nfon	EU	The relevant public will isolate the syllable 'fon' in the sign 'nfon', and perceive this term as relating equally to the words 'telephone' or 'phone.' (para. 60).	T-283/11 (C-193/13 P dismissed)

Examples of cases that are not broken down visually but where all the parts suggest a concrete meaning known to the relevant public:

Sign	Territory	Concept	Case
Ecoblue	EU	The word element 'eco' is a common prefix or abbreviation in many languages spoken in the European Union, while the word 'blue' is English for the colour blue and part of the basic English vocabulary known to the relevant public.	T-281/07 (C-23/09 P dismissed)

Solfrutta/ FRUTISOL	EU	The elements 'sol' and 'frut' are generally recognisable and can be understood as alluding to 'sun' and 'fruit' respectively.	T-331/08
RIOJAVINA	EU	The term 'riojavina' in the mark applied for refers directly, so far as the relevant public is concerned, to grapevine products and, more particularly, Rioja wine.	T-138/09 (C-388/10 P rejected)

Finally, cases where only one part has a clear meaning are usually ones where there is a common prefix or suffix, for example:

Sign	Territory	Concept	Case
	DE	'DERMA' may be perceived as referring to goods of a dermatological nature.	B 1 249 467





As explained above, all three exceptions have to be construed narrowly; therefore, where it is not obvious that a part or parts suggest(s) a concrete meaning known to the relevant public, examiners should refrain from looking for these meanings *ex officio*. In the examples below, no concept was found in the signs:

Sign	Territory	Concept	Case
ATOZ	DE, ES, FR, IT, AT	The TM will not be perceived as 'from A to Z'. The letters 'to' (corresponding to an English preposition) do not stand out in any way from the letters 'a' and 'z'.	T-100/06 (C-559/08 P dismissed)
SpagO	BX	The word 'SpagO' is an invented word that has no meaning in any of the official languages of Benelux countries. It should not be perceived as a combination formed by SPA + GO.	T-438/07
CITRACAL --- CICATRAL	ES	The word elements 'cica' and 'citra' do not have any concrete meaning, any more than the endings 'tral' and 'cal'. The signs at issue are, therefore, not likely to be broken down by the public into word elements that have a concrete meaning or resemble words known to it and that, together, would form a coherent whole giving a meaning to each of the signs at issue or to any one of them.	T-277/08

3.4.3.3 The semantic content of misspelled words

It is not necessary for a word to be written properly for its semantic content to be perceived by the relevant public. For example, while the written word 'XTRA' is visually not the same as the 'correct' word 'EXTRA', because it is aurally identical to it, the concept of the 'correct' word (extra) will normally be transferred to the misspelled word (xtra).

The following examples illustrate this point:

Sign	Territory	Concept	Case
	EU	Part of the relevant public will regard it as a reference to the English word 'store', meaning 'shop, storage'.	T-309/08
CMORE	EN	CMORE will, in view of the common practice of sending text messages, probably be associated by a significant part of the general public in Denmark and Finland with an abbreviation or misspelling of the verb 'to see' in English, with the concept being perceived as 'see more'.	T-501/08 'SEE MORE/CMORE'
	EN	The word 'ugli' in the earlier mark is likely to be associated with the English word 'ugly' by the relevant public.	T-488/07
	EU	The term contained in the mark will bring to consumers' minds the idea of 'yogurt', i.e. 'a semi-solid, slightly sour, food prepared from milk fermented by added bacteria'.	B 1 142 688
	ES	The words 'KARISMA' and 'C@RISMA' refer to 'charisma' or 'charism', i.e. a special personal quality or power of an individual, making him/her capable of influencing or inspiring large numbers of people.	B 1 012 857

Examiners should take care when attaching meaning to a misspelled word: the meaning is not likely to be transferable when the words are not (aurally) identical and/or when the misspelled element cannot be perceived independently:

Mark	Territory	Concept	Case
Bebimil	EU	The mark applied for does not contain the word 'baby' but a fanciful word, which is further removed and without any clear and specific meaning, i.e. 'bebi'.	T-221/06

3.4.3.4 The semantic content of names and surnames

The General Court has accepted that names have a concept. Therefore, a conceptual comparison must be made when conflicting signs are composed of names (see examples below).

Nevertheless, there are few situations where the fact that a trade mark contains a family name has conceptual significance. In particular, conceptual similarity cannot result from the mere fact that both trade marks contain a name, even the same kind of name (Celtic family name, Dutch name, etc.).

Mark	Territory	Concept	Case No
MCKENZIE/ McKINLEY	EU	The relevant public recognises the prefix 'Mc', signifying 'son of', as a prefix to many Scottish or	T-502/07

		Irish family names. That public will, therefore, regard the word elements of the marks at issue as Celtic family names of no conceptual significance, unless the name is particularly well known as that of a famous person.	
VANGRACK/ VAN GRAF	DE	The fact that both marks may be perceived as lower German or Dutch surnames is on its own neutral for comparison purposes.	R 1429/2010-4

The mere fact that two names can be grouped under a common generic term of 'names' does not constitute conceptual similarity. For example, if FRANK and MIKE are compared: the fact that both are names would not lead to a finding of conceptual similarity; this is because the public is not likely to make the conceptual link between the two words. By contrast, the fact that FRANK and FRANKIE are the same name but the latter is the diminutive of the former is relevant and should lead to a finding of conceptual similarity.

Marks	Territory	Concept	Case No
SILVIAN HEACH (FIG.)/ H. EICH	Italy and other territories	Whereas 'HEACH' would be perceived as a surname of Anglo-Saxon origin, the element 'EICH' would be perceived as a surname of German origin (para. 66). In view of this, the consumers would realise that these surnames distinguish different persons. The signs are conceptually different (para. 69).	T-557/10

The fact that a trade mark contains a name may have an impact on conceptual comparison in the following situations:

- (a) When it is the name/surname of a well-known person (CERVANTES, MARCO POLO, PICASSO):

Mark	Territory	Concept	Case No
PICASSO	EU	The word sign PICASSO has a clear and specific semantic content for the relevant public. The reputation of the painter Pablo Picasso is such that it is not plausible to consider, in the absence of specific evidence to the contrary, that the sign PICASSO as a mark for motor vehicles would, in the perception of the average consumer, override the name of the painter.	T-185/02 (C-361/04 P dismissed)

- (b) Where the two marks represent the same name but in different versions (FRANK, with FRANKIE as a diminutive) or languages, such as in the following examples:

Marks	Territory	Concept	Case No
	EU	The relevant public is certain to regard these as highly similar female names derived from the same root. In certain Member States, notably the United Kingdom, Ireland, Germany and Austria, they will certainly be perceived by the relevant public as diminutives of the full forename Elizabeth.	T-130/09
PEPEQUILLO/PEPE	ES	The Spanish public will understand 'Pepequillo' as a diminutive of 'Pepe', leading to conceptual identity.	T-580/08
JAMES JONES/JACK JONES	EU	Both trade marks may be understood as referring to the same person.	T-11/09

- (c) When both trade marks can be understood as referring to the same person, especially when the earlier trade mark is composed solely of a family name. This could be the case when one name is more important than the other:



Mark	Territory	Concept	Case No
CTMA: Julián Murúa Entrena Earlier mark: MURUA,	ES	The CTMA contains a Spanish name (a forename and two surnames). The first surname, which for the Spanish public is the more important one, coincides with the earlier TM.	T-40/03
CTMA: MANSO DE VELASCO Earlier mark: VELASCO	ES	Velasco is a Spanish surname. The CTMA can be understood as being composed of two surnames.	T-259/06
CMTA: Antonio Basile Earlier mark: BASILE	IT	The signs are conceptually similar in that they share the same surname (para. 60).	T-133/09 and T-134/09

- (d) If the name contained in the trade marks is meaningful in some language, the coincidence in this meaning may lead to conceptual similarity:



Mark	Territory	Concept	Case No
peerstorm/PETER STORM	EU, UK	English-speaking consumers will associate the surname Storm with bad weather (para. 67).	T-30/09

3.4.3.5 The semantic content of figurative signs, symbols, shapes and colours

The concepts of marks consisting of or containing figurative elements and marks consisting of shapes (three-dimensional marks) will be what those figurative elements or shapes represent, such as in the following examples:

Mark	Territory	Concept	Case No
	BX, DE, ES, FR, IT, AT, PT	The representation of a red mug on a bed of coffee beans.	T-5/08 to T-7/08
	DE	Part of the relevant public may recognise a peacock.	T-361/08
	BX	The contested trade mark will be described as a businessman playing football.	R 0403/2009-2

Consequently, when a mark has both words and images, all concepts have to be assessed.

Mark	Territory	Concepts	Case No
	EN	The word 'ugli' in the earlier mark is likely to be associated with the English word 'ugly' by the relevant public. A bulldog with a citrus fruit in front of it.	T-488/07
	EU	The term 'Rioja' in the earlier mark, which is itself conceptually strengthened by the representation of a bunch of grapes and a vine leaf, refers directly to grapevine products and, more particularly, to Rioja wine.	T-138/09 (C-388/10 P rejected)
	BL, BX, CY, DE, ES, FR, HU, RO, SK, IT	The mark depicts a type of fish (a shark). The majority of the relevant language speakers will understand the term SPAIN in the contested mark as referring to that country. The word 'Tiburón' means 'shark' in Spanish but will not be understood by the rest of the relevant public. The remaining term, SHARK, will probably be understood by English-speaking consumers in the relevant territories.	B 1 220 724

Finally, the semantic content (concept) of colour marks *per se* is that of the colour they reproduce.



3.4.3.6 The semantic content of numbers and letters

The concept of a word representing a number is the figure it identifies, such as in the example below:

Mark	Territory	Meaning	Case No
	DE	The word zero evokes the cardinal number 0.	T-400/06
TV2000 (fig.)/TV1000	LT	The signs are conceptually similar to the extent that they both share the idea of 'television' combined with a round four-digit number, that furthermore correlate in the order of thousands (para. 47).	R 2407/2011-2
7 (fig.)/7 (fig.)	EU	The BoA found that '7' had a meaning (para. 25).	R 0782/2011-2

The concept of a figure is the number it identifies, unless it suggests another concept such as a specific year.

The Office follows the approach that single letters can have an independent conceptual meaning. The Court has confirmed this approach (judgment of 08/05/2012, T-101/11, G, EU:T:2012:223, § 56, appealed as C-341/12 P, G, EU:C:2013:206), finding conceptual identity where both trade marks can be seen as the same letter:

Mark	Territory	Meaning	Case No
	DE	For the part of the relevant public that interprets the signs as the letter 'e' and the part of the relevant public that interprets them as the letter 'c', the signs are conceptually identical (para. 99).	T-22/10
	EU	The signs were considered conceptually identical (paras 60-61).	T-187/10

3.4.3.7 The semantic content of geographical names

The names of cities, villages, regions and other geographic areas evoke a concept that may be relevant for conceptual comparison if it is likely that the relevant public will recognise them as such. Usually, the general public in Europe is familiar with the names of capitals and bigger cities as well as holiday or travel destinations. If the perception of the public in a particular Member State is relevant, knowledge of the names of small cities and towns in that country can also be assumed.

A lack of evidence or indication that the relevant public recognises the geographical name does not influence the conceptual comparison. See the following example:

Mark	Territory	Concept	Case No
	DE	The result of conceptual comparison is neutral. It is not possible to infer from the appellant's argument that the name Chtaura designates an	R 1213/2008-4

v 		agricultural area in Lebanon renowned for its agricultural products that this meaning will also be familiar to trade circles in Germany.	
--	--	--	--

3.4.3.8 The semantic content of onomatopoeias

The analysis of the semantic content of onomatopoeias follows the general rules for conceptual comparison: their concept will be that depicted by the onomatopoeia in question, provided it can be established that it will be recognised as such by the relevant public. For instance, ‘WOOF WOOF’ represents the bark of a dog for English speakers; ‘MUUU’ represents the mooing of a cow for Spanish speakers.

Mark	Territory	Concept	Case No
CLICK	DE	Conceptually, the contested mark ‘CLICK’ is an English onomatopoeia that expresses a short, sharp sound. This word will be readily understood in Germany given its close equivalent in German, ‘Klick’ (para. 45).	R 1394/2006-2

In some cases, the context in which the onomatopoeia will be used can be decisive for establishing whether the relevant public will recognise its meaning. For instance, in the following case, the Board considered that the relevant public would not interpret the sign ‘PSS’ as onomatopoeia in the context of information technology services:

Mark	Territory	Concept	Case No
PSS	ES	The applicant’s argument that the earlier mark could also be pronounced as an onomatopoeia [prompting another to be quiet] is far-fetched in view of the relevant information technology services at issue and the relevant public, who is accustomed, as noted by the applicant itself, to acronyms in this field (para. 42).	R 1433/2007-2

3.4.4 How to make a conceptual comparison

In essence, when making a conceptual comparison, the examiner has first to determine if the signs have a concept in accordance with the principles described in the previous paragraph.

If none of the signs have any concept, the outcome will be that a **conceptual comparison is not possible**.

If only one of the signs evokes a concept, the outcome will be that the signs are **not conceptually similar**.

When both signs have a concept, the concept(s) will be compared to establish whether the signs are conceptually **identical** or **similar** (i.e. they refer to the same or similar concepts) or **dissimilar** (i.e. the signs refer to different concepts).



The signs will be conceptually dissimilar where there are two words for which a generic term covering both of them exists and/or when the two signs fall under the same general category of signs. If the semantic meanings are too different, the signs may share a general concept, but one so broad that the conceptual relationship is not relevant. In these cases no conceptual similarity will be found. For example:



- The mere fact that the two words or symbols can be **grouped under a common generic term** by no means constitutes a case of conceptual similarity. For example, in the case of ‘Jaguar’ v ‘Elephant’, the fact that both are animals would not lead to a finding of conceptual similarity because the public is not likely to make a conceptual link between the two words. In fact, because the words refer to different animals, they should be considered conceptually dissimilar.
- The same happens when two signs belong to the **same type of mark or word**: the fact that ‘TDI’ and ‘LNF’ are three-letter abbreviations is conceptually irrelevant. The signs should be considered conceptually dissimilar.
- Another example of signs ‘belonging to the same category’ concerns **names** and surnames that have a similar semantic content (see paragraph 3.4.3.4 above). If FRANK and MIKE are compared, the fact that they are both names is conceptually irrelevant (since they are on completely different levels); by contrast, the fact that FRANK and FRANKIE are the same name but the latter is the diminutive of the former is relevant and should lead to a finding of conceptual similarity in that case.

In particular, the marks will be conceptually identical or similar when:







Both marks share a word and/or expression

When the two marks share the same word or expression, the marks will be conceptually similar, as in the following examples:

Earlier sign	Contested sign	Opposition No
		B 1 209 618 (ES)
Similar: the marks share the concept of SOL (= sun: ‘the star that is the source of light and heat for the planets in the solar system’).		
Earlier sign	Contested sign	Case No
BLUE	ECOBBLUE	T-281/07 (C-23/09 P dismissed) (EU)
The marks at issue are conceptually similar because they both refer to the colour blue.		
Earlier sign	Contested sign	Opposition No
T-MUSIC		B 1 081 167 (EU)
The marks above are conceptually similar because both refer to the concept of MUSIC (= ‘the art of arranging sounds in time so as to produce a continuous, unified, and evocative composition, as through melody, harmony, rhythm, and timbre’).		

Earlier sign	Contested sign	Opposition No
		B 1 220 724 (BL, BX, CY, CZ, DE, ES, FR, HU, RO, SK and IT)
The marks above are conceptually similar because both signs have an image of the same fish (a shark) and a reference to the word SHARK (= 'any of numerous chiefly marine carnivorous fishes of the class Chondrichthyes (subclass Elasmobranchii) ...').		
Earlier sign	Contested sign	Case No
EL CASTILLO	CASTILLO	T-85/02 (ES)
The Court found that the signs were almost identical conceptually.		
Earlier sign	Contested sign	Case No
Servus et al.	SERVO SUO	T-525/10 (EU, IT in particular)
The signs are conceptually similar from the point of view of the average Italian consumer insofar as both signs share a reference to 'servant'. The Court confirmed the BoA finding that the Italian public was likely to perceive the meaning of the Latin word 'SERVUS', given its proximity to the Italian word 'SERVO'.		

As already mentioned, misspellings may also have a semantic content and in such cases can be compared, as in the following examples:

Earlier mark	Contested sign	Case No
		T-485/07 (ES)
For the relevant Spanish public both signs invoke the concept of an olive. There is no evidence that the relevant Spanish consumer will understand the English word 'live'.		
Earlier sign	Contested sign	Opposition No
		B 1 142 688 (EU)
Both marks refer to the word yogurt and consequently share the concept of 'a dairy product produced by bacterial fermentation of milk'.		
Earlier sign	Contested sign	Opposition No
		B 1 012 857 (ES)

The above marks are conceptually similar because they both refer to the concept of ‘charisma’ (= ‘the ability to develop or inspire in others an ideological commitment to a particular point of view’).

Two words or terms have the same meaning but in different languages

It is possible for the relevant public to assign a conceptual similarity or even identity in cases of marks with elements in different languages, as long as the meanings of the words in those languages are known to that public.

In the following example, it was found that the marks were conceptually identical because a substantial part of the Portuguese public would understand the words constituting the marks at issue given (i) the close proximity of the English word ‘vitamin’ to the Portuguese equivalent term ‘vitamina’, (ii) ‘water’ is a basic English word likely to be understood by that part of the Portuguese public that has sufficient knowledge of the English language (iii) that ‘aqua’ is a widespread Latin expression and resembles the Portuguese equivalent term ‘água’ (paras 56-60):

Earlier mark	Contested sign	Case No
VITAMINWATER (relevant territory Portugal)		T-410/12

As it is the actual understanding of the relevant public that matters, the mere fact that one term is objectively the foreign-language equivalent of the other may not be relevant at all in the conceptual comparison.

Earlier mark	Contested sign	Case No
	LE LANCIER	T-265/09

The relevant territory is Spain. ‘El lancero’ (in Spanish) means ‘le lancier’ in French. Conceptually, the GC concluded that the average Spaniard only had a limited knowledge of French and that the expression ‘le lancier’ did not belong to the basic vocabulary of that language. Conceptually, the signs are not similar.

Two words refer to the same semantic term or variations thereof

There is conceptual identity where synonyms are involved, i.e. where two words exist for the same semantic meaning (invented examples where English is the reference language: baggage/luggage; bicycle/bike; male horse/stallion).

Conceptual similarity was found in the following cases:





Earlier mark	Contested mark	Case No
SECRET PLEASURES	PRIVATE PLEASURES	R 0616/1999-1

	<p>ORPHAN INTERNATIONAL</p>	<p>R 1142/2009-2</p>
---	-----------------------------	----------------------

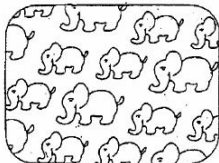

Two figurative signs, symbols and/or shapes represent the same object or idea

When two marks consist of or contain figurative elements and/or shapes and they represent the same or similar objects or ideas, the signs will be conceptually identical or similar.

The following are cases where conceptual identity or similarity was found:

Earlier mark	Contested mark	Case No
		<p>T-424/10 (identity)</p>
		<p>R 0703/2011-2 (identity)</p>
		<p>R 1107/2010-2 (identity)</p>

However, the fact that both signs contain the same object does not lead to a finding of conceptual similarity if the way in which the object is depicted in the conflicting trade marks is different.

Earlier mark	Contested mark	Case No
		<p>T-593/10</p>
<p>The GC considered that the Board was right in finding that the signs are conceptually different given that the earlier mark, due to its figurative element and the way in which the letter 'b' is depicted, could evoke a boomerang whereas this is not the case for the mark applied for (para. 36).</p>		

Furthermore, even if both signs contain the same element, they may be found **dissimilar** if they evoke different concepts due to their overall impression:

Earlier mark	Contested mark	Case No
		<p>T-143/11</p>
<p>The mark applied for resembles an armorial emblem recalling the distinctive symbol associated with nobility or guilds used to identify people or professions, whereas the earlier marks are more akin to a seal indicating the mark of a sovereign authority such as that of the State and are designed to certify, or even seal, a particular object. (para. 48).</p>		

When there is a word v a figurative sign, symbol, shape and/or colour representing the concept behind the word

Conceptual identity also exists between a word and an image showing what the word represents (fictional examples: word mark 'TIGER' compared with a figurative mark depicting a tiger; or word mark 'orange' and a mark for the colour orange per se).

Earlier mark	Contested mark	Case No
		<p>T-389/03 (EU, identity for part of the public)</p>

3.4.5 Impact of the distinctive and dominant character of the components on the similarity of signs

At each level (visual, phonetic and conceptual) the comparison of signs will lead to a decision as to whether the marks are similar and if so, to what degree. In general, the more commonalities there are between marks; the higher their degree of similarity.

However, this finding depends, first, on whether the coincidence is recognisable or rather remains unnoticed in the overall impression of both marks (paragraph 3.4.5.1 below), and furthermore, on the distinctiveness and dominant character of the common elements (paragraph 3.4.5.2 below), and also the impact of the remaining elements in the overall impression of the marks (paragraph 3.4.5.3 below).

3.4.5.1 Identifiable common element/coincidence

Two marks are similar when, from the point of view of the relevant public, they are at least partly identical as regards one or more relevant aspects (judgment of 23/10/2002, T-6/01, Matratzen, EU:T:2002:261, § 30). The coincidence must be, therefore, 'relevant' from the perspective of the consumer who usually perceives a mark as a

whole and does not proceed to analyse its various details (judgment of 13/02/2008, T-146/06, Aturion, EU:T:2008:33, § 58).

The coincidence is clearly perceived when the commonality forms an independent word element or when it is separated in the way of writing (use of an upper case letter, special character, hyphen or other punctuation mark):

Earlier sign	Contested sign	Reason	Case No
BEYOND VINTAGE	BEYOND RETRO	Coinciding first word	T-170/12
SCHUHPARK	JELLO SCHUHPARK	The earlier TM is identical to the second word of the CTMA.	T-32/03
ip_law@mbp	MBP	The sign '@' separates the earlier mark in 'ip-law' and 'mbp' (para. 53).	T-338/09

Sometimes the graphical representation allows the separation of different elements of the mark and identification:

Earlier sign	Contested sign	Reason	Case No
		The letters 'FLK' have an independent role in the CTMA due to the red colour (para. 48).	T-19/12

Furthermore, the common word can be identified as such in an isolated manner because of its clear meaning. An average consumer perceiving a word sign will break it down into elements that suggest a concrete meaning or resemble known words (judgment of 06/10/2004, T-356/02, Vitakraft, EU:T:2004:292, § 51, confirmed by C-512/04 P). In the following examples, the common element is a part of a word, but could be identified since the public will logically split the word according to the meaning of its elements:

Earlier sign	Contested sign	Reason	Case No
MARINE BLEU	BLUMARINE	The part 'marine' in the CTMA will be understood as a reference to the sea and 'blu' as a misspelling of 'blue'.	T-160/12
CADENACOR	COR	The Spanish-speaking public will identify the elements 'cadena' and 'cor' in the earlier TM (para. 47) — likelihood of confusion.	T-214/09
BLUE	ECOBUE	The relevant public will split the CTMA into the commonly used prefix 'eco' and the word 'blue' (para. 30) — likelihood of confusion.	T-281/07 confirmed by C-23/09 P)

On the contrary, if it remains unnoticed, the mere coincidence in a string of letters is not enough for a finding of similarity. The rule remains that the public compares the marks as a whole and will not artificially dissect them. In the following cases **the similarity of**

the marks was denied despite an overlap in some letters (see also paragraph 4 below, ‘Dissimilarity of signs’, especially paragraph 4.2.4, ‘Overlap in other irrelevant aspects’.

Earlier sign	Contested sign	Reason	Case No
AAVA MOBILE	JAVA	The resemblances that result from the presence of the common letters ‘ava’ are completely offset by the significant differences between those signs (para. 45).	T-554/12
CS	CScreen	The contested sign will probably be broken down into the elements ‘C’ and ‘Screen’, which is highly relevant for computers and their peripherals. It will not be perceived as containing the separate entity ‘CS’ corresponding to the earlier mark.	R 545/2009-4

3.4.5.2 Distinctiveness and dominant character of the common elements

For the conclusion of similarity, the **degree of distinctiveness of the common element** (or elements) must be taken into account. The more distinctive the common element is, the higher the degree of similarity in each aspect of the comparison (visual, phonetic and conceptual). A finding that the common element has a limited distinctiveness will lower the similarity, with the consequence that if the only common element of both marks is non-distinctive, the degree of similarity at all levels of comparison will be low or that even — depending on the impact of the elements that differentiate the marks — the similarity will be entirely denied¹⁰.

In the following examples, the common element was considered descriptive or otherwise non-distinctive, with the consequence that the level of similarity was considered low:



Earlier sign	Contested sign	Case No
FSA K-FORCE.	FORCE-X	T-558/13
The element ‘force’ has a weak distinctive character for the goods concerned. Low visual, phonetic and conceptual similarity — no likelihood of confusion.		

Earlier sign	Contested sign	Case No
ACTU+	News+	T-591/13
The presence of the ‘+’ sign in both signs cannot generate a visual similarity as this is a mathematical symbol that implies a concept of increase, so it only enjoys a weak distinctive character (para. 29). The signs share a weak similarity on the phonetic side because of the presence of the ‘+’ sign (paras 35-36) — no likelihood of confusion.		

Earlier sign	Contested sign	Case No
VISCOPEX	VISCOTECH	T-138/13
As regards the common initial part of the marks ‘visco’, it is descriptive for the German public with		

¹⁰ See paragraph 4.2.5 below, Overlap in a non-distinctive element.

relation to one of the main characteristics of the relevant goods (oils, greases and fuels), namely its viscosity (para. 57). The marks are only vaguely similar visually and phonetically — no likelihood of confusion.

Earlier sign	Contested sign	Case No
		T-60/11

The word premium is laudatory (para. 44). The coincidence leads only to a low visual and phonetic and an average conceptual similarity — no likelihood of confusion.

Earlier sign	Contested sign	Case No
	ULTIMATE GREENS	R-1462/2012-G

The word 'ultimate' is a promotional word used to indicate the superior quality of the latest goods available on the market and, has no distinctive character at all (para. 22). Even if both trade marks share this element, there is only a low visual and phonetic similarity (paras 47-48). No conceptual similarity overall (para. 49) — no likelihood of confusion.

The fact that the coinciding element is a non-distinctive element, does not, however, suffice to deny any similarity between the marks, unless there are further factors differentiating them (see paragraph 4.2.5 below). If the public will notice the overlap, it must be taken into account in the comparison. The fact that an element is descriptive or otherwise non-distinctive is not on its own sufficient to conclude that that word is negligible in the overall impression produced by that mark (judgment of 08/02/2011, T-194/09, *Líneas aéreas del Mediterráneo*, EU:T:2011:34, § 30).

(For the impact of common weak or non-distinctive components on likelihood of confusion see Chapter 7, Global Assessment).

The conclusion on visual similarity has to be taken further into account **if the common element is dominant** (visually outstanding) or at least co-dominant in the overall impression of the marks. As explained above (see paragraph 3.3) within the assessment of the dominant character of one or more components, the intrinsic qualities (size, striking graphical representation, etc.) of each of those components have to be compared with the intrinsic qualities of the other components. In addition and accessorially, account may be taken of the relative position of the various components within the arrangement of the composite mark (23/09/2014, T-341/13, *So'bio etic*, EU:T:2014:802, § 67).

The distinctiveness and dominant character of the common element(s) are separate but co-related terms. According to the Court:

It should also be noted that where some elements of a trade mark are descriptive or non-distinctive, they are not generally regarded by the public as being dominant in the overall impression conveyed by that mark, unless, particularly because of their position or their size, they appear likely to make an impression on consumers and to be remembered by them.



(Judgment of 31/01/2013, T-54/12, Sport, EU:T:2013:50, § 24 and the case-law cited).

3.4.5.3 Importance of additional (not common) elements



Within the comparison of trade marks as a whole, the impact of the non-common elements in their overall impression also has to be taken into account in order to reach a conclusion on similarity. The more differences the remaining elements of the marks present, the lower would be the similarity resulting from the common element.

It cannot be generally assumed that the elements of difference between the marks would tend to become less marked in the consumer’s memory in favour of the elements of similarity. In accordance with settled case-law, the extent of the similarity or difference between the signs at issue may depend, in particular, on the inherent qualities of the signs (13/05/2015, T-169/14, Koragel/CHORAGON, EU:T:2015:280, § 84).

The distinctiveness and dominant character of the differentiating elements has to be, therefore, taken into account. If these elements are the distinctive ones and dominate the overall impression of the marks, the level of similarity will decrease:

Earlier sign	Contested sign	Case No
		T-338/12
<p>As regards the visual comparison, the figurative element representing a dog in the earlier mark constitutes the dominant one. Given that the respective graphic elements are different, the coincidence in the word element 'K9' leads to a visual similarity only to a low degree. The marks are phonetically similar to a high degree. As to the conceptual comparison, the contested mark does not contain any figurative element conveying the concept of a dog, the marks are not conceptually similar (paras 27-34).</p>		

On the contrary, if the element in which the marks differ is of less inherent distinctiveness than the common element, this will increase the level of similarity:

Earlier sign	Contested sign	Case No
	 (NEGRA MODELO)	R-0536/2001-3 (confirmed: T-169/02)
The earlier TM was a Portuguese registration. 'Negra' is descriptive for the relevant goods in Class 33, since it may be used in Portuguese to designate brown beer, i.e. the type of beer sold under the trade mark NEGRA MODELO. The attention of the average Portuguese consumer will be focused on the coinciding word 'modelo'. Low visual, average phonetic and strong conceptual similarity — likelihood of confusion.		

3.4.6 Other principles to be taken into account in the comparison of signs

3.4.6.1 Impact of word elements v figurative elements on the visual and conceptual comparison

When signs consist of both verbal and figurative components, in principle, the verbal component of the sign usually has a stronger impact on the consumer than the figurative component. This is because the public does not tend to analyse signs and will more easily refer to the signs in question by their verbal element than by describing their figurative elements (judgment of 14/07/2005, T-312/03 Selenium-Ace, EU:T:2005:289, § 37; decisions of 19/12/2011, R 0233/2011-4, Best Tone, § 24; and 13/12/2011, R 0053/2011-5, Jumbo, § 59).

However, the verbal element of a sign does not automatically have a stronger impact (judgment of 31/01/2013, T-54/12, Sport, EU:T:2013:50, § 40).



Moreover, in assessing the impact of the verbal element of a composite trade mark, account should be taken of the distinctiveness of this element.

(a) Signs with an identical or very similar verbal element and different figurative elements



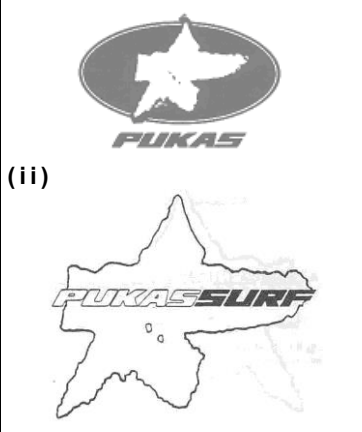

When the verbal elements are identical or similar and the figurative element has neither semantic meaning nor striking stylisation, the signs are usually similar. In this scenario, the figurative element will be considered not to have a significant influence in the relevant public's perception of the sign:

Earlier sign	Contested sign	Case No (level of similarity)
(i)	PUKKA	T-483/10 (high visual and phonetic similarity. No conceptual similarity)

 <p>(ii)</p>		
<p>G&S: Class 18 Territory: Spain, EU Assessment: The figurative elements of the earlier Community trade mark — namely, the oval and the geometric shape vaguely recalling a five-point star superimposed thereon — do not convey any identifiable conceptual content. Consequently, it is highly unlikely that these figurative elements will hold the attention of the relevant consumer. By contrast, although the verbal element does not convey any conceptual content either, the fact remains that it may be read and pronounced and that it is, therefore, likely to be remembered by consumers. Therefore, the verbal element of the earlier Community trade mark must be considered to dominate the visual impression made by that mark (para. 47).</p>		



Earlier sign	Contested sign	Case No (level of similarity)
		<p>T-216/11 (average visual and high phonetic similarity. No conceptual comparison possible)</p>
<p>G&S: Class 29 Territory: EU Assessment: Visual similarity results from the fact that both have a unique verbal element very similar only differing in the final letter. Both figurative signs had the representation of a bird, an element that added to the similarity of the signs. The signs have little and minor differences only. On the aural comparison both signs have a high degree of aural similarity having only one final letter difference. The conceptual comparison is not relevant as the verbal element of the signs had no meaning in some parts of the European Union (para. 38).</p>		
Earlier sign	Contested sign	Case No
<p>CINEMA 4D</p>		<p>R 1691/2014-2</p>
<p>G&S: Class 9 Territory: EU Assessment: 'In respect of the figurative elements of which the sign is comprised, the Board considers that there is nothing in these elements that adds anything different to the contested sign other than some elements of decoration. The mere addition of banal figurative elements will not affect the perception of the sign by the relevant public' (para. 24).</p>		



In contrast, when the common verbal elements are likewise weak or even less distinctive than the figurative elements, the coincidence in the verbal elements leads to only low similarity, if there are differences in the figurative elements:

Earlier sign	Contested sign	Case No (level of similarity)
		T-60/11 (low visual and phonetic and average conceptual similarity)
<p>G&S: Classes 30, 31, 42 Territory: EU Assessment: The similarity of the marks is based solely on a word that has no distinctive character and would not be remembered by consumers as the key element of the marks at issue (para. 53).</p>		
Earlier sign	Contested sign	Case No (level of similarity)
		R 1357/2009-2 (no visual or conceptual similarity, remote phonetic similarity)
<p>G&S: Classes 5, 29, 30, 32 Territory: EU Assessment: The BoA took into account the non-distinctive and descriptive character of the word 'Lactofree' for the relevant goods. The Board found the notable visual and conceptual differences between the signs (para. 98).</p>		

(b) Signs with an identical or very similar figurative element and different verbal elements

In general, the identity or similarity of the figurative component of signs will not lead to a considerable level of similarity where at least one of the signs contains a further verbal component that is not contained in the other sign. The outcome will however depend on the particular circumstances in each individual case.

Earlier sign	Contested sign	Case No (level of similarity)
		T-311/08 (low visual similarity, phonetic and conceptual dissimilarity)
<p>G&S: Classes 25, 41, 43 Territory: France Assessment: Taking into account the dominant character of the verbal element in the mark applied for, there is no phonetic and conceptual similarity and only a low degree of visual similarity between the signs (para. 58) — no likelihood of confusion.</p>		

Earlier sign	Contested sign	Case No (level of similarity)
		R 0280/2009-4 (visual, phonetic and conceptual dissimilarity)
<p>G&S: Classes 16, 36, 41 <i>Territory:</i> Germany <i>Assessment:</i> The only thing the two signs have in common is that they depict a cross with eight characteristic points, known as a 'Maltese cross', referring to the Order of Malta. Even in the area in question, 'charitable fundraising; education, periodicals; medical services' (Classes 16, 36, 41, 45), the specific Maltese cross shape is not used exclusively by the appellant. The CTMA contains the unreservedly distinctive word sequence 'Pro concordatia populorum' and cannot be reduced to its figurative element. The signs are also dissimilar phonetically, as the opposing sign has no verbal elements. There is no conceptual similarity, as the CTMA means 'for the understanding of the peoples', a phrase that has nothing in common with the earlier sign. Therefore, there can be no likelihood of confusion, even in the case of the identical goods found only in Class 16.</p>		



This rule does not apply to the cases where the verbal element is of limited distinctiveness and not dominant:

Earlier sign	Contested sign	Case No (level of similarity)
		Joint R 0068/2001-4 and R 0285/2001-4 (high visual similarity)
<p>G&S: Classes 18, 24, 25, 28 <i>Territory:</i> Benelux, Germany, Spain, France, Italy, Austria <i>Assessment:</i> the wording 'La Maison de la Fausse Fourrure' is not sufficient to reduce the impression of similarity between the conflicting marks. In addition to its possibly descriptive nature, the Board notes that the wording is given, relative to the footprint device, a secondary position (it is placed under the device), a relatively limited size (four times smaller) and a conventional writing style (para. 22).</p>		

- (c) Signs with figurative elements corresponding to the meaning of the verbal elements

The figurative element may 'cooperate' with the verbal part in defining a particular **concept** and may even help with the understanding of words that, in principle, might not be widely known to consumers. This will strengthen the conceptual similarity:

Earlier sign	Contested sign	Case No
		B 210 379
<p>G&S: Class 3 <i>Territory:</i> Germany, Spain <i>Assessment:</i> The figure of a moon, present in both signs, made the equivalence between the Spanish and English words 'LUNA' and 'MOON' clearer to Spanish consumers.</p>		

Earlier sign	Contested sign	Case No
		R 1409/2008-2
<p>G&S: Classes 18, 25, 35 Territory: EU Assessment: Visually, the trade marks are highly similar. An aural comparison is not possible. Conceptually, the word 'horse' will be understood by English-speaking consumers as a direct reference to the figurative element of the contested CTM. Therefore, the marks are conceptually identical.</p>		

3.4.6.2 Beginning of the signs in the visual and phonetic comparison

In word signs or in signs containing a verbal element, the first part is generally the one that primarily catches the consumer's attention and, therefore, will be remembered more clearly than the rest of the sign. This means that in general the beginning of a sign has a significant influence on the general impression made by the mark (judgments of 15/12/2009, T-412/08, Trubion, EU:T:2009:507, § 40; 25/03/2009 T-109/07, Spa Therapy, EU:T:2009:81, § 30).

Nevertheless, the concept 'beginning of the sign' is undetermined, as there is no particular indication of what forms the beginning, what is the end or even if there is or is not a middle part of the sign. Again, this perception mostly depends on the circumstances of the case (length of sign, syllabic distribution, use of typeface, etc.) and not on a set rule. It could even be that a sign is perceived as having a short beginning and ending and a proportionally much larger middle or central part. Consequently, depending on the circumstances, the rule of the relevance of the beginning of the sign could have less weight to the benefit of a more relevant central part.

As it is usually the beginning of a sign that catches consumers' attention, where signs only differ in their endings, this difference is often insufficient to exclude similarity. However, this is not a fixed rule and the outcome depends on the circumstances of the case. Moreover, this rule only applies when the sign contains a verbal element (which would explain the reading from left to right) and when this verbal element is not very short (otherwise the sign will be perceived immediately in its entirety). The Office considers signs consisting of three or fewer letters/numbers as very short signs (see in more detail paragraph 3.4.6.3 below).

In principle, coincidences at the beginning of signs increase their similarity more than in the middle or at the end:

Earlier sign	Contested sign	Case No
ALENTIS	ALENSYS	R 1243/2010-1
<p>G&S: Class 42 Territory: Spain Assessment: While both marks do not have any meaning and, thus, no conceptual comparison can be made, the trade marks are visually and phonetically highly similar, in particular because they coincide in their first four letters 'ALEN'. It is generally accepted that people pay more attention to the first part of a trade mark, at least when they perceive the mark visually (para. 33).</p>		

Earlier sign	Contested sign	Case No
AZURIL	AZULIB	R 1543/2010-1
G&S: Class 5 Territory: Greece Assessment: The signs share five of their six letters and the first two syllables are identical. There is a certain degree of visual similarity. Aurally the signs are highly similar as the initial part, which is normally the most important, is identical. Neither sign has a meaning in Greek (paras 35-36).		

However, the degree of similarity will usually be lower, despite identical beginnings, if those are the weak elements in the signs or if the remaining elements have a clearly different meaning:

Earlier sign	Contested sign	Case No
CALSURA	CALSORIN	R 0484/2010-2
G&S: Class 5 Territory: EU Assessment: Visually, the marks share some similarity due to the coinciding letters 'C', 'A', 'L', 'S' and 'R' placed in the same order. Aurally, there is a low degree of similarity. Conceptually, the marks are similar insofar as they both contain the component 'CAL'. However, since this element clearly alludes to the kind of goods (containing 'calcium'), not much weight can be given to this conceptual similarity (paras 21-23) — no likelihood of confusion.		
Earlier sign	Contested sign	Case No
NOBLESSE	NOBLISSIMA	R 1257/2010-4
G&S: Class 30 Territory: Denmark, Finland, Sweden Assessment: The signs differ in the fifth letter and in their ending. They are visually similar to an average degree. In view of the length of the CTMA, the signs differ in rhythm and intonation and are thus aurally similar to a low degree. The earlier signs 'NOBLESSE' do have a clear connotation in both Finland and Sweden. In these territories, the word 'NOBLISSIMA' lacks any meaning. They are, therefore, conceptually dissimilar. The earlier marks are laudatory in nature and to a certain extent descriptive of the characteristics of the goods 'chocolate', namely describing their superior character. The distinctive character is below average.		
Earlier sign	Contested sign	Case No
ALBUMAN	ALBUNORM	R 0489/2010-2
G&S: Class 5 Territory: EU Assessment: Visually, phonetically and conceptually the signs are similar insofar as they have the prefix 'ALBU' (abbreviation of 'albumin' or 'albumen') in common. But this similarity is of little significance because the prefix is generic and so devoid of distinctiveness. The second element of the earlier mark, 'MAN', is visually, phonetically and conceptually completely different from the second element, 'NORM', of the contested mark.		

3.4.6.3 Short signs

The comparison of signs must be based on the **overall impression** given by the marks.

The length of signs may influence the effect of the differences between them. In principle, the shorter a sign, the more easily the public is able to perceive all its single elements. In contrast, the public is usually less aware of differences between longer signs. **However, each case must be judged on its own merits, having regard to all the relevant factors.**

The Courts have not exactly defined what a short sign is. However, signs with three or less than three letters/numbers are considered by the Office as short signs. The paragraphs below thus analyse the impact on the overall impression, and thus, on the similarity of the respective signs for one-, two- and three-letter/number signs.

The comparison between signs consisting of a single letter or a combination of three or less than three letters not recognisable as a word, **follows the same rules** as that for word signs comprising a word, a name or an invented term (judgments of 06/10/2004, T-117/03 to T-119/03 and T-171/03, NL, EU:T:2004:293, § 47-48; 10/05/2011, T-187/10, G, EU:T:2011:202, § 49).



(a) Single-letter/Single-number signs

It follows from the case-law of the Court that in the assessment of likelihood of confusion between signs comprising the same single letter, **visual comparison** (see paragraph 3.4.1.6 above) is, in principle, decisive. The aural and conceptual identity may be overridden, in the assessment of likelihood of confusion, by sufficient visual differences between the signs (see Chapter 7, Global Assessment, paragraph 7.1, ‘Short signs’).

(b) Two-letter/number signs

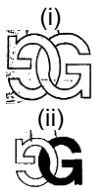

The over-mentioned rule on the importance of visual comparison applies to two-letter/number marks accordingly. The comparison of these signs depends on their stylisation and, especially, on whether the letters are recognisable as such in the sign. Consequently, the visual overall impression of the signs may be different when two conflicting signs, albeit containing or consisting of the same combination of two-letters, are stylised in a sufficiently different way or contain a sufficiently different figurative element, so that their different overall graphical representation eclipses the common verbal element.

In the following examples, the **marks were found visually similar** due to the graphic representations/visual similarities of the same two-letter combinations:

Earlier sign	Contested sign	Case No
		B 61 046
<p>G&S: Class 36 Territory: Spain Assessment: The overall visual impression of the conflicting marks is that they consist of two letters in an arbitrary figurative design that conveys the same impression. The trade marks are considered similar.</p>		
Earlier sign	Contested sign	Case No
<p>GE</p>		T-520/11

G&S: Classes 6, 7, 9, 11, 17
 Territory: UK
 Assessment: It cannot be excluded that part of the relevant public will interpret the contested mark as the letter combination 'GE' (paras 33-35). The marks are phonetically identical and visually similar to a medium degree. As regards the conceptual comparison, it cannot be excluded that part of the relevant public will interpret the contested mark as the letter combination 'GE'.

In the following example, **the signs were found visually and phonetically dissimilar** due to the different graphic representation and the fact that they may not be read as the same letters.

Earlier sign	Contested sign	Case No
(i)  (ii) 		R 0082/2011-4

G&S: Class 33
 Territory: EU
 Assessment: From a visual point of view, the graphic stylisation of the earlier marks is very different compared with the contested mark. The mere fact that one or both letters of the marks are identical is not enough to render the marks visually similar. There is no aural similarity if the contested mark will be pronounced as 'B' or 'PB' as in short signs differences have a higher impact on the overall impression than in longer marks. Conceptually, the contested mark and the earlier marks with no additional elements to the letter combination 'AB' do not have a meaning in any of the relevant languages: the conceptual comparison remains thus neutral (paras 17-19).

As to the difference in one of the letters see the following examples:

Earlier sign	Contested sign	Case No
(i) CX (ii) 	KX	R 0864/2010-2

G&S: Class 7
 Territory: EU
 Assessment: Visually, the initial letters 'K' and 'C' show a clearly different shape and can be considered only visually similar to a low degree. The same degree of similarity — low — applies for the phonetic comparison. Aurally, the signs will be pronounced 'K-X' and 'C-X' respectively, and not as words. Neither of the marks has a conceptual meaning (paras 25-27).

Earlier sign	Contested sign	Case No
KA		T-486/07

G&S: Classes 9, 11, 12
 Territory: EU
 Assessment: It must be concluded that, for each of the possible perceptions by the relevant public of the mark applied for, that public will perceive significant visual differences for each of the earlier marks (para. 65). Some degree of phonetic similarity between the marks at issue must be recognised, but it is not very high. Without making an error, the Board of Appeal, therefore, could find that the phonetic similarity between the marks at issue was not 'notable' (para. 71). As both marks have no meaning, no conceptual comparison can be made (para. 72).

(c) Three-letter/number signs

When the signs in conflict are three-letter/number signs, a difference of one letter does not exclude similarity, especially if this letter is phonetically similar.





Earlier sign	Contested sign	Case No
	ELS	T-388/00

G&S: Classes 16, 35, 41
 Territory: Germany
 Assessment: Two of the three letters are identical and in the same sequence; the difference in a single letter does not constitute a significant visual and aural difference. The letters 'E' and 'I' in Germany are pronounced similarly (paras 66-71).

Earlier sign	Contested sign	Case No
Ran	R.U.N.	T-490/07

G&S: Classes 35, 38, 42
 Territory: EU, Germany
 Assessment: The Court held that the signs in the mind of the relevant consumer, having a good command of the English language, are visually, aurally and conceptually similar (para. 55).

In contrast, when trade marks are composed of only three letters, with no meaning, the difference of one letter may be sufficient to render them not similar:

Earlier sign	Contested sign	Case No
(i)  (ii)  (iii) 		R 0393/1999-2

G&S: Class 25
 Territory: Benelux, Germany, Spain, France, Italy, Portugal, Austria
 Assessment: In this case the pronunciation of the first letters of the marks in dispute, i.e. 'J' and 'T', is different in all relevant languages. These letters are also visually dissimilar. Furthermore, the figurative elements of the compared marks do not resemble each other (paras 17-18).

Earlier sign	Contested sign	Case No
	COR	T-342/05
<p>G&S: Class 3 Territory: Germany <i>Assessment:</i> The GC considered that the signs were only aurally similar to a low degree (paras 47 and 50). The relevant public in Germany will certainly notice the differences in the beginning of the signs.</p>		

3.5. Conclusion on similarity

Each aspect of (visual, phonetic and conceptual) the comparison of signs leads to a decision as to whether the marks are similar and if so, to what degree. In general, the more commonalities that exist between marks, the higher the degree of similarity.

An assessment of similarity between two marks means more than taking just one component of a composite trade mark and comparing it with another. On the contrary, the comparison must be made by examining each of the marks in question as a whole, which does not mean that the overall impression conveyed to the relevant public by a composite trade mark may not, in certain circumstances, be dominated by one or more of its components.

The conclusion as to the degree of similarity of the signs at each of the three levels is the result of an evaluation of all of the relevant factors. The main factors that may impact on an assessment of similarity have been explained in the previous paragraphs of this chapter. It should be borne in mind that in an assessment of similarity, the relevant factors (dominance, distinctiveness, etc.) are considered not only for the purpose of determining the common elements of marks, but also to establish any differing and/or additional elements in conflicting signs.

In general, the following should be considered when assessing similarity and degrees of similarity:

- Impact of the distinctiveness of the elements

The greater or lesser degree of distinctiveness of the elements is common to signs, and is one of the relevant factors in assessing the similarity between signs.

For example, if the coincidences between the signs of each of the three aspects of comparison derive from an element with limited distinctiveness, the established degree of visual, aural and/or conceptual similarity will be lower than where the elements in common have a normal distinctiveness.

- Impact of the dominant elements

The conclusion on visual similarity has to be taken further into account if the common element is dominant (visually outstanding) or at least co-dominant in the overall impression of the marks.

It should also be noted that where some elements of a trade mark are descriptive or non-distinctive, they are not generally regarded by the public as being dominant in the

overall impression conveyed by that mark, unless, particularly because of their position or their size, they appear likely to make an impression on consumers and to be remembered by them.

It should be emphasised that the abovementioned factors may not be applicable to all cases and the assessment of similarity is always undertaken on a case-by-case basis and a consideration of further factors may be necessary. Furthermore, it should be noted that the above factors and principles do not call into question the principle that the examination of the similarity of trade marks must take into account the overall impression produced by them on the relevant public.

- Impact of word v figurative elements

When signs consist of both verbal and figurative components, in principle, the verbal component of the sign usually has a stronger impact on the consumer than the figurative component. Therefore, if the coincidences between composite signs (signs comprising word and figurative elements) lie within the verbal elements and the differences arise out of the figurative elements, the degree of visual and aural similarity is likely to be higher than average.

In general, the identity or similarity of the figurative component of the signs is insufficient to establish a considerable level of similarity where at least one of the signs contains a further verbal component that is not contained in the other sign.

However, although the word elements of a mark may have a greater impact, this is not necessarily the case where the figurative element visually dominates the overall impression made by the mark.

- Beginning of signs

In principle, coincidences at the beginning of signs increase their similarity more than coincidences in the middle or at the end of signs.

Therefore, consumers attach less importance to the end of the mark and coincidences located at the end of signs would lead to a finding of a lower degree of visual similarity than common elements at the beginning of signs. Likewise, the position of the coinciding/similar phonemes or syllables at the beginning of the conflicting signs would increase the degree of aural similarity.

However, the degree of similarity will usually be lower, despite identical beginnings, if those are the weak elements in the signs or if the remaining elements have a clearly different meaning.

- Short signs

The length of the signs may influence their overall impression and thus the effect of the differences between them. In principle, the shorter a sign, the more easily the public is able to perceive all its single elements. In contrast, the public is usually less aware of differences between longer signs.

The application of the abovementioned principles and factors should not be automatic. The decision has to explain their relevance for the particular case and weigh them up.

However, the rules explained in this chapter have a general character and the particularities of a specific case may justify different findings. However, in such cases it is of even greater importance to provide a clear and thorough reasoning in the decision.

4 Dissimilarity of Signs

4.1 Introduction

The similarity of signs is a necessary condition for a finding of a likelihood of confusion under Article 8(1)(b) CTMR. An assessment of the similarity between two marks must be based on the **overall impression** created by them, in particular, by their distinctive and dominant components (judgment of 23/10/2002, T-6/01, Matratzen, EU:T:2002:261, § 32 and the case-law cited therein). Where the overall impression is that the signs are dissimilar, this excludes the likelihood of confusion.

The finding as to whether signs are similar or dissimilar overall is the result of a combined assessment of (i) the visual, phonetic, conceptual overlaps and differences and (ii) the significance of the overlaps and differences in the perception of the relevant public.

Where the signs at issue are dissimilar,

- the general rule is that the goods and services do not need to be compared. Only the signs are compared and the examination stops upon concluding on the dissimilarity of the signs.

Nevertheless, reasoning strategy may justify a comparison of some of the goods and services and continue the assessment of the similarity of signs for the remaining goods and services only, where the signs are otherwise dissimilar due to an overlap exclusively in a descriptive or non-distinctive element (see paragraph 4.2.5 below). For example, in the case of long lists of goods and services, it may prove more efficient to first rule on the dissimilarity of some of the goods and services, and continue to the comparison of the signs (including the assessment of distinctive components in several languages) only for the remaining, shorter list of goods and services.

- any claim of enhanced distinctiveness is not examined. If the signs are dissimilar, the opposition under Article 8(1)(b) CTMR must be rejected regardless of any enhanced distinctiveness of the earlier mark. Where the marks in question are not similar, there is no need to take account of the reputation of the earlier mark, since it does not fall within the scope of the test of similarity and cannot serve to increase the similarity between those marks (order of 14/03/2011, C-370/10 P, EDUCA Memory game, EU:C:2011:149, § 50-51 and the case-law cited therein).
- there is no global assessment of factors. The decision concludes that in the absence of one of the conditions, the opposition under Article 8(1)(b) CTMR must be rejected.

4.2 Scenarios for dissimilarity

4.2.1 No element in common



The signs are obviously dissimilar if they have nothing in common in any of the three aspects of comparison. This is more a hypothetical scenario as the signs at issue in an opposition under Article 8(1)(b) CTMR normally have something in common. What is rather debated by the parties is the significance of the overlap in an element.

4.2.2 Overlap in a negligible element

The signs are dissimilar if the only element they have in common is **negligible** in one or both of the marks in the sense that, due to its size and/or position, it will be likely to go **unnoticed** or **disregarded** by the relevant public. Negligible elements, after **having duly reasoned** why they are considered negligible, will not be compared (judgment of 12/06/2007, C-334/05 P, Limoncello, EU:C:2007:333, § 42). The notion of negligible elements should be strictly interpreted and, in the event of any doubt, the assessment should cover all the elements of the sign (see paragraph 1.5 above).

Concerning the assessment as to whether an element is negligible, the test is not whether the Office can, in a meticulous side-by-side examination of the signs, decipher the element concerned. The question is rather whether, in the overall impression of the sign, the element is noticeable by the average consumer who normally perceives a sign as a whole and does not proceed to analyse its various details.

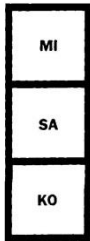
Examples:

Earlier sign	Contested sign	Case No
	 <p>(GREEN BY MISSAKO)</p>	<p>T-162/08</p> <p>The words 'by missako' are almost illegible: the size and script make them difficult to decipher</p>
 <p>(RL RÓTULOS LUNA S.A.)</p>	<p>LUNA</p>	<p>R 02347/2010-2</p> <p>The element 'Rótulos Luna S.A.' was considered negligible</p>

4.2.3 Overlap in a verbal element not noticeable due to high stylisation

The signs are dissimilar if the verbal element, which would give rise to similarity, is not discernible due to its high stylisation. Sometimes the way in which letters or symbols are used makes it unrealistic to assume that they will be read and pronounced, for example, when in a figurative mark a symbol or letter is repeated in order to create a pattern or is highly distorted or otherwise not clearly legible. If the verbal element is not

recognisable in the overall impression of the sign, thus, not legible and not pronounceable, it will not be taken into account in the comparison.

Again, the test is not whether the Office can, in a meticulous side-by-side examination of the signs, identify the verbal element concerned. It is irrelevant if the verbal element is recognised only with the help of the other mark, as the consumer normally does not have the opportunity to compare signs side by side. Furthermore, it is irrelevant that the party refers to its mark by a particular verbal element in its submissions or if the particulars of the mark indicate a verbal element, because the consumer will not be assisted by that information on encountering the sign as registered or applied for.

Examples:

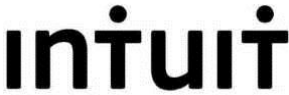
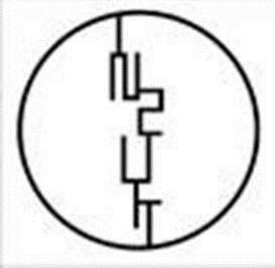
Earlier sign	Contested sign	Case No
KA		R 1779/2010-4
		R 0164/2015-2

The question whether the verbal element is indeed ‘lost’ in the stylisation must be carefully assessed. The consumer intuitively looks for pronounceable elements in figurative signs by which the sign can be referred to. The high stylisation of one or more letters of a word may not prevent the consumer from identifying the verbal element as a whole, particularly, if it suggests a concrete meaning. It should also be emphasised that if the complex stylisation of the verbal element of a sign does not make it totally illegible, but merely lends itself to various interpretations, the comparison must take into account the different realistic interpretations. Thus, it is only in the — rather rare — case where the legibility of the sign is truly unrealistic, without being assisted by a mark description or the other mark, that the verbal element will be disregarded in the comparison.



4.2.4 Overlap in other irrelevant aspects

The fact that there is some coincidence between the signs does not necessarily lead to a finding of similarity. This is in particular the case when the overlapping part is not perceived independently within the overall impression of the marks. The Court considered the following signs dissimilar despite the overlap in a sequence of letters:



Examples:



Earlier sign	Contested sign	Case No
AAVA MOBILE	JAVA	T-554/12
The resemblances that result from the presence of the common letters 'ava' are completely offset by the significant differences between those signs (para. 45).		

Earlier sign	Contested sign	Case No
ALDI		T-240/13
The conflicting signs are visually different. The figurative elements and the additional word 'foods', must not be disregarded when comparing the signs (paras 54-55). The overall visual impression of the conflicting signs is clearly different (paras 59-60). The signs are also phonetically different bearing in mind, in particular, the additional element 'foods' of the contested mark (para. 64). Finally, the marks are also conceptually not similar (para. 73).		

Earlier sign	Contested sign	Case No
		T-524/11
The figurative elements of the earlier figurative marks further distinguish those marks from the mark applied for (para. 36). The signs at issue have a different rhythm of pronunciation (paras 43-44). The words have no meaning, it is not possible to carry out a conceptual comparison (para. 54).		

The same applies to similarities in the figurative elements that are of minor impact:

Earlier sign	Contested sign	Case No
		T-36/13
The figurative elements of the signs have the same outline but will be perceived as different by the relevant public (paras 45-47). The word elements are visually different since they have only two letters in common, which are also placed in distinct positions.		

Earlier sign	Contested sign	Case No
		<p>B 1 837 106</p>
<p>The marks coincide only in that the verbal elements are written in white on a contrasting grey background and the white frame that separates the verbal and the landscape elements in equal parts. These are commonplace figurative elements, omnipresent in marks in virtually all fields of trade. The consumer's attention is not caught by any of these details, but rather by the fanciful term 'tukaş' in the earlier mark and by the word 'Ekonomik' in the contested mark. As the signs visually overlap only in irrelevant aspects and have nothing in common aurally and conceptually, they are dissimilar overall.</p>		

The decision must contain a thorough reasoning, in the comparison of signs, as to why the overlap in particular aspects is considered irrelevant.

4.2.5 Overlap in a non-distinctive element

If the signs overlap exclusively in an element that is **descriptive** or otherwise **non-distinctive** for the relevant goods and services in all parts of the relevant territory, and they contain other distinctive element(s) capable of differentiating between the signs, they can be considered dissimilar.

It follows that two signs may be dissimilar for part of the goods and services but not for others. If in part of the relevant territory the overlapping element is not perceived as descriptive or non-distinctive (e.g. due to non-understanding of the term), the signs cannot be considered dissimilar.

Invented examples:

Earlier sign	Contested sign
HOTEL FRANCISCO	HOTEL PARIS
<p><i>Goods and services:</i> provision of accommodation <i>Territory:</i> European Union</p>	
CASA ENRIQUE	CASA RACHEL
<p><i>Goods and services:</i> provision of restaurant services <i>Territory:</i> Spain (where 'casa' has also the meaning 'bar', 'restaurant')</p>	
MARKET.COM	FITNESS.COM
<p><i>Goods and services:</i> telecommunications services <i>Territory:</i> European Union</p>	

Examples from case-law:

Earlier sign	Contested sign	Case No
	<p>CARBON CAPITAL MARKETS</p>	<p>T-563/08 (paras 39-61)</p>
<p><i>Goods and services:</i> Class 36 <i>Territory:</i> European Union (relevant public considered to be familiar with basic English financial terminology) <i>Assessment:</i> The common element 'capital markets' directly describes the services.</p>		
<p>MAX&Co.</p>	<p>M&Co.</p>	<p>T-272/13</p>
<p><i>Goods and services:</i> Classes 25 and 35 <i>Territory:</i> European Union <i>Assessment:</i> The common element '&Co.' is non-distinctive and always used in the same position — after the distinctive part of the company name.</p>		

However, despite a lack of distinctive character of the elements in common, it would not be appropriate to conclude on dissimilarity, where

- the particular combination of the elements confer distinctiveness on the signs (i.e. the combination would be protected);
- the other element that is supposed to distinguish between the signs is (i) perceived as an insignificant figurative detail, or is (ii) otherwise non-distinctive;
- the non-distinctive elements constituting (forming exclusively) the sign are entirely incorporated in the other sign.

In summary, the finding of 'dissimilar overall' on account of an overlap exclusively in non-distinctive elements should be limited to evident cases where the other element serves to safely distinguish between the signs.

Less evident cases should not be solved at the stage of the comparison of signs, but rather in the global assessment (see the Guidelines, Part C, Opposition, Section 2, Double Identity and Likelihood of Confusion, Chapter 7, Global Assessment, paragraph 6, Impact of weak or non-distinctive elements on likelihood of confusion, subparagraph 6.2, Common elements with no distinctiveness).

***GUIDELINES FOR EXAMINATION IN THE
OFFICE FOR HARMONIZATION IN THE
INTERNAL MARKET (TRADE MARKS AND
DESIGNS) ON COMMUNITY TRADE MARKS***

PART C

OPPOSITION

SECTION 2

***DOUBLE IDENTITY AND
LIKELIHOOD OF CONFUSION***

CHAPTER 5

DISTINCTIVENESS OF THE EARLIER MARK

Table of Contents

1	General Remarks	3
2	Assessment of Distinctiveness of the Earlier Mark.....	3
2.1	General issues.....	4
2.1.1	Distinctiveness.....	4
2.1.2	Inherent and enhanced distinctiveness	5
2.1.3	Relevant point in time	6
2.1.4	Relevant goods and services	6
2.2	Examination of inherent distinctiveness of the earlier mark.....	6
2.2.1	General principles.....	6
2.2.2	Specific themes	7
2.2.2.1	One-letter signs, numerals and short signs	7
2.2.2.2	Collective marks	9
2.3	Examination of enhanced distinctiveness.....	9

1 General Remarks

The European Court of Justice (the Court) held in its judgment of 29/09/1998, C-39/97, Canon, EU:C:1998:442, § 18 and 24:

... marks with a highly distinctive character, either *per se* or because of the reputation they possess on the market, enjoy broader protection than marks with a less distinctive character.

... the distinctive character of the earlier trade mark, and in particular its reputation, must be taken into account when determining whether the similarity between the goods or services covered by the two trade marks is sufficient to give rise to the likelihood of confusion.

It is important to distinguish between (i) the analysis of the distinctive character of the earlier mark as a whole, which determines the scope of protection afforded to that mark, and (ii) the analysis of the distinctive character of a component of the marks within their comparison¹.

Whereas distinctive character must be assessed for the components of both the earlier mark and the contested mark, distinctiveness of the mark as a whole is assessed only in respect of the earlier mark². The distinctiveness of the contested mark as a whole is not relevant, as such, to the assessment of likelihood of confusion, as explained in more detail in paragraph 2.1.2 below. Therefore, any reference below to the distinctiveness of the mark *as a whole* refers exclusively to the earlier mark.

The impact of the distinctiveness of the earlier mark as a whole comes into play when the global assessment is conducted, because the Court has held that it is not appropriate to take account of what may be a low or high degree of distinctiveness of the earlier mark at the stage of assessing the similarity of the signs (judgments of 23/01/2014, C-558/12 P, Western Gold, EU:T:2012:1257, § 42-45; 25/03/2010, T-5/08 and T-7/08, Golden Eagle/Golden Eagle Deluxe, EU:T:2010:123, § 65; 19/05/2010, T-243/08, EDUCA Memory game, EU:T:2010:210, § 27).

2 Assessment of Distinctiveness of the Earlier Mark

The Canon judgment makes clear that (i) the more distinctive the earlier mark, the greater will be the likelihood of confusion and (ii) earlier marks with a highly distinctive character because of the reputation they possess on the market, enjoy broader protection than marks with a less distinctive character. Consequently, the distinctive character of the earlier mark as a whole determines the strength and breadth of its protection and must be taken into consideration for the purposes of assessing likelihood of confusion (but not for assessing similarity between the marks — see ‘Western Gold’ et al. above).

¹ See the Guidelines, Part C, Section 2, Double Identity and Likelihood of Confusion, Chapter 3, Comparison of the Signs.

² See also Objective 1 of the Common Practice on the impact of non-distinctive/weak components on likelihood of confusion agreed within the framework of the European Trade Mark and Design Network (ETMDN).

2.1 General issues

2.1.1 Distinctiveness

The Court has defined distinctiveness in the following manner:

In determining the distinctive character of a mark and, accordingly, in assessing whether it is highly distinctive, the national court must make an overall assessment of the greater or lesser capacity of the mark to identify the goods or services for which it has been registered as coming from a particular undertaking, and thus to distinguish those goods or services from those of other undertakings (emphasis added).

(Judgment of 22/06/1999, C-342/97, Lloyd Schuhfabrik, EU:C:1999:323, § 22).

Importantly, distinctive character is a matter of degree and, when analysing distinctiveness, a sliding scale applies, whereby a sign can lack distinctiveness entirely, be highly distinctive or be at any point in-between.

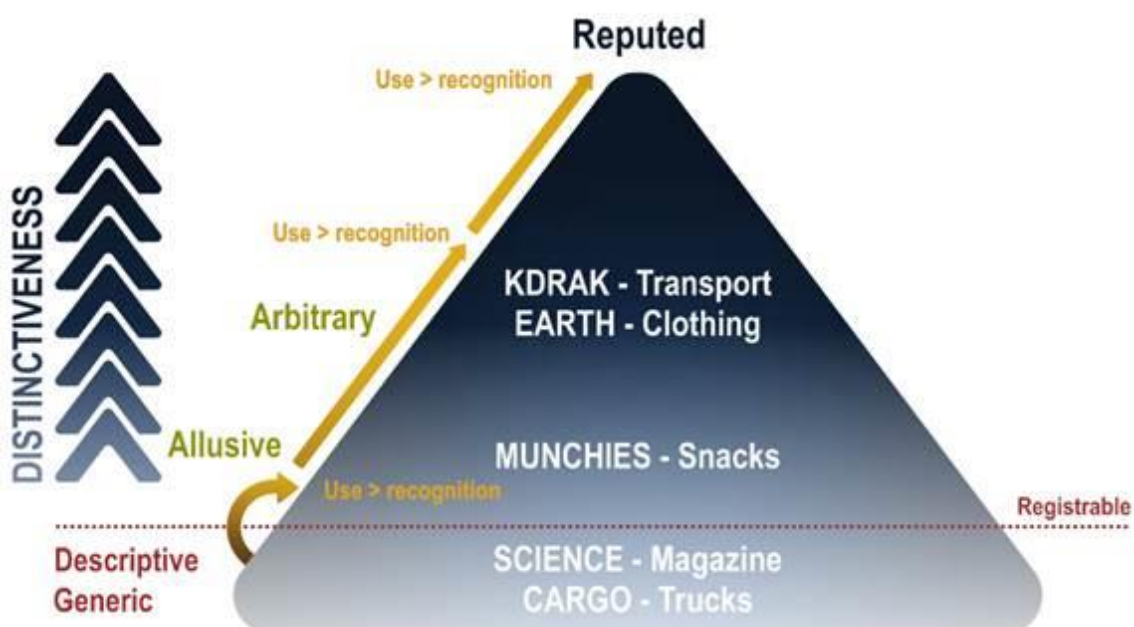

A sign is **not distinctive** if it is exclusively descriptive of the goods and services themselves or of the characteristics of those goods and services (such as their quality, value, purpose, provenance, etc.) and/or if its use in trade is common for those goods and services. Similarly, a sign that is generic (such as a common shape of a container or a common colour) will also lack distinctiveness.

A sign may be **distinctive to a low degree** if it alludes to (but is not exclusively descriptive of) characteristics of the goods and services. If the allusion to the goods and services is sufficiently imaginative or clever, the mere fact that there is an allusion to characteristics of the goods might not materially affect distinctiveness. For example:

- 'Billionaire' for *gaming services* is allusive in a manner that would affect distinctiveness, because it implies for instance that you may become a billionaire.

- ‘Billy O’Naire’, which sounds identical to ‘billionaire’ in English, would be allusive for *gaming services* as a clever wordplay on Irish names, in a manner that would not affect distinctiveness in a material way; it would be considered to have a ‘normal’ degree of distinctiveness.

A sign that is neither descriptive nor allusive is deemed to possess a **‘normal’ degree of inherent distinctiveness**. This means that the sign in question is fully distinctive, in the sense that its capacity to identify the goods and services for which it has been registered as coming from a particular undertaking is not in any way diminished or impaired.

Any **higher degree of distinctiveness** acquired by the earlier mark has to be proven by its proprietor by submitting appropriate evidence (see paragraph 2.3 below). A mark will not necessarily have a higher degree of distinctive character just because there is no conceptual link to the relevant goods and services (order of 16/05/2013, C-379/12 P, H/Eich, EU:C:2013:317, § 71).

Likewise, a CTM applicant may argue that the earlier sign is distinctive to a low degree. One of the most frequent arguments brought by applicants is that the earlier trade mark or one of its components has low distinctive character given that there are many trade marks that consist of, or include, the element in question. Where this argument is supported only by the applicant’s referring to trade mark registrations, the Office takes the view that the existence of several trade mark registrations is not per se particularly conclusive, as it does not necessarily reflect the situation in the market. In other words, on the basis of register data only, it cannot be assumed that all the trade marks have been effectively used.

It follows that the evidence filed must demonstrate that consumers have been exposed to widespread use of, and become accustomed to, trade marks that include the element in question in order to prove that this element has a low degree of distinctive character.

When dealing with the distinctiveness of the **earlier mark as a whole**, the latter should always be considered **to have at least a minimum degree of inherent distinctiveness**. Earlier marks, whether CTMs or national marks, enjoy a ‘presumption of validity’. The Court made it clear, in its judgment of 24/05/2012, C-196/11, F1-Live, EU:C:2012:314, § 40-41, that ‘in proceedings opposing the registration of a Community trade mark, the validity of national trade marks may not be called into question’. The Court added that ‘it should be noted that the characterisation of a sign as descriptive or generic is equivalent to denying its distinctive character’³.

2.1.2 Inherent and enhanced distinctiveness

The Office must consider, as a first step, the overall inherent distinctiveness of the earlier mark (see paragraph 2.2 below) and, as a second step, if claimed and relevant for the outcome, whether the earlier mark has acquired enhanced distinctiveness as a consequence of the use the opponent has made of it (see paragraph 2.3 below).

³ See also Objective 1 of the Common Practice on the impact of non-distinctive/weak components on likelihood of confusion agreed within the framework of the ETMDN.

The degree of distinctiveness of the earlier sign is one of the factors to be taken into account in the overall assessment (judgment of 11/11/1997, C-251/95, Sabèl, EU:C:1997:528, § 23). It is a matter of law, which must be examined by the Office even if the parties do not comment on it. In contrast, the degree of enhanced distinctiveness acquired through use of the earlier sign is a matter of law and fact, which the Office cannot examine unless the opponent claims and substantiates it in due time (see the Guidelines, Part C, Opposition, Section 1, Procedural Matters, paragraph 4.2, Substantiation).

The inherent distinctiveness of the contested trade mark *as a whole* is not examined within the framework of the opposition proceedings, as it is the scope of protection of the earlier mark that is relevant for the purposes of likelihood of confusion. Likewise, the enhanced distinctiveness of the contested sign is also irrelevant because likelihood of confusion requires a consideration of the scope of protection of the earlier mark rather than that of the mark applied for. If an earlier mark is recognised as having a broader scope of protection by reason of its enhanced distinctiveness, the reputation acquired by the *mark applied for* is, as a matter of principle, irrelevant for the purpose of assessing likelihood of confusion (judgment of 03/09/2009, C-498/07 P, La Española, EU:C:2013:302, § 84).

2.1.3 Relevant point in time

The inherent distinctiveness of the earlier mark(s) should be assessed at the time of the decision. The enhanced distinctiveness of the earlier trade mark(s) (if claimed) should exist (i) at the time of filing of the contested CTM application (or any priority date) and (ii) at the time of the decision.

2.1.4 Relevant goods and services

The assessment of the *inherent distinctiveness* of the earlier mark is carried out only for the goods or services that have been found to be identical or similar to the contested goods and services.

Assessment of the *enhanced distinctiveness* of the earlier mark is carried out only in respect of the goods or services protected by the sign for which enhanced distinctiveness is claimed.

Furthermore, it is the perception of the relevant public for these goods and services that is of relevance (e.g. whether a specialist public is involved or not).

2.2 Examination of inherent distinctiveness of the earlier mark

2.2.1 General principles

The first step in examining the distinctiveness of the earlier mark is to examine its inherent distinctiveness. The same rules and principles apply as those for the examination of distinctiveness of components, in terms of the relevant public and its linguistic and cultural background, relevant territory, relevant goods and services, etc. (see Chapter 4, paragraph 3.2 of this Section).

At the stage of determining the distinctiveness of the earlier mark as a whole, distinctiveness of its various components (or its only component) has already been established in the section on comparison of signs. In principle, if an earlier mark contains a normally distinctive component, then the inherent distinctiveness of such an earlier mark as a whole is also normal, regardless of the possible presence of other non-distinctive or weak components. If the most distinctive component of the earlier mark is distinctive only to a low degree, then in principle the overall inherent distinctiveness of that mark will be no more than low.

As mentioned above, earlier registered trade marks are presumed to have at least a minimum degree of inherent distinctiveness⁴, even where persuasive evidence is submitted to challenge this presumption. If the CTM applicant proves that it has started a cancellation action against the earlier registered mark, then it might be necessary to suspend the opposition proceedings pending the outcome of said action.

The outcome of the examination of inherent distinctiveness of the earlier mark as a whole will be one of the following.

- The earlier mark has **less than normal distinctiveness** because, as a whole, it is allusive (in a way that materially affects distinctiveness) or laudatory of the characteristics of identical or similar goods or services (or because it is otherwise weak). As set out above, the Office will not conclude that an earlier mark as a whole is descriptive and/or non-distinctive.
- The earlier mark has **normal distinctiveness** because, as a whole, it is not descriptive, allusive (in a way that materially affects distinctiveness) or laudatory (or is not otherwise weak) in relation to identical or similar goods or services.

It should be noted that it is Office practice, when an earlier mark is not descriptive (or is not otherwise non-distinctive), to consider it as having no more than a normal degree of inherent distinctiveness. As indicated above, this degree of distinctiveness can be further enhanced if appropriate evidence is submitted showing that a higher degree of distinctiveness of the earlier mark has been acquired through use or because it is highly original, unusual or unique (26/03/2015, T-581/13, Royal County of Berkshire POLO CLUB (fig.)/BEVERLEY HILLS POLO CLUB *et al.*, EU:T:2015:192, § 49, last alternative). It should, however, be recalled that a mark will not necessarily have a higher degree of distinctive character just because there is no conceptual link to the relevant goods and services (order of 16/05/2013, C-379/12 P, H/Eich, EU:C:2013:317, § 71).

2.2.2 Specific themes

2.2.2.1 One-letter signs, numerals and short signs

The Court, in its judgment of 09/09/2010, C-265/09 P, α , EU:C:2010:508 held that the distinctiveness of single-letter trade marks must be assessed according to an examination based on the facts, focusing on the goods or services concerned and the **same criteria that apply to other word marks** (paragraphs 33-39). Although that judgment deals with absolute grounds, the Office considers that the principle established by the Court (i.e. that the application of the criterion of distinctiveness must

⁴ See the judgment of 24/05/2012, C-196/11, F1-Live, EU:C:2012:314, cited in paragraph 2.1.1 above.

be the same for all marks) also applies in *inter partes* cases when it comes to determining the distinctiveness of single-letter trade marks.

The Court, while acknowledging that it may prove more difficult to establish distinctiveness for marks consisting of a single letter than for other word marks, held that these circumstances do not justify laying down specific criteria supplementing or derogating from application of the criterion of distinctiveness as interpreted in the case-law.

The Office considers the ruling to mean that, when establishing the distinctiveness of an earlier mark, it is not correct to rely on assumptions such as *a priori* statements that consumers are not in the habit of perceiving single letters as trade marks or on generic arguments such as that relating to the availability of signs, given the limited number of letters.

The General Court has since stated in a number of cases that a trade mark containing a **single letter** or a single numeral may indeed be inherently distinctive (judgments of 08/05/2012, T-101/11, G, EU:T:2012:223, § 50; 06/10/2011, T-176/10, Seven for all mankind, EU:T:2011:577, § 36; 05/11/2013, T-378/12, X, EU:T:2013:574, § 37-51).

In its judgment of 10/05/2011, T-187/10, G, EU:T:2011:202, the General Court dismissed the applicant's argument that single letters are generally per se devoid of distinctive character and that therefore only their graphic representation would be protected (see paragraphs 38 and 49).

Consequently, whilst registered **earlier trade marks consisting of a single letter (or numeral) represented in standard characters** enjoy a presumption of validity, ultimately their degree of inherent distinctiveness will have to be assessed with reference to the goods and/or services concerned.

If the corresponding claim is made, account should be taken of evidence submitted by the opponent that demonstrates that its registered trade mark consisting of a single letter has acquired **enhanced distinctiveness**. This circumstance could lend the earlier trade mark a broader scope of protection.

The above considerations apply both to single-letter/-numeral trade marks represented in standard characters (i.e. word marks) and to stylised single-letter/-numeral trade marks.

Where the opponent has successfully proven that its single-letter trade mark has acquired enhanced distinctiveness through intensive use, the impact thereof on the final outcome has to be carefully assessed. Firstly, enhanced distinctiveness on the part of the earlier single-letter trade mark cannot justify a finding of likelihood of confusion if the overall visual impression conveyed by the signs is so different as to safely set them apart. Secondly, if the evidence shows use of a single-letter trade mark that is stylised or accompanied by additional figurative elements, the benefit of the resulting broader scope of protection accrues to the form in which it was used and not to the single letter as such or any other stylised variation.

Furthermore, in accordance with the 'α' judgment, as regards **short signs**, unless a letter combination, as such, is intrinsically non-distinctive for the goods and services (e.g. 'S' or 'XL' for goods in Class 25), these signs are not necessarily distinctive only to a low degree. The same rules apply to numerals.

2.2.2.2 Collective marks

Where the mark on which the opposition is based is a collective mark, its inherent distinctiveness is to be assessed in the usual way. The mark may have a low or even very low degree of inherent distinctiveness when it refers to the nature or other characteristics of the goods concerned. The fact that the mark is a collective mark does not imply that its scope of protection is broader (judgments of 13/06/2012, T-534/10, Hellim, EU:T:2012:292, § 49-52 and 05/12/2012, T-143/11, F.F.R. EU:T:2012:645, § 61).

2.3 Examination of enhanced distinctiveness

After the obligatory **examination of inherent distinctiveness** (see paragraph 2.1.3 above), the second step is to check — provided the opponent has made the corresponding claim⁵ — whether the earlier mark has acquired enhanced distinctiveness at the time of filing (or priority date) of the contested CTM application as a consequence of the use that the opponent has made of it.

The distinctiveness of the earlier mark always has to be taken into account when deciding on likelihood of confusion. The more distinctive the earlier trade mark, the greater will be the likelihood of confusion (judgment of 11/11/1997, C-251/95, Sabèl, EU:C:1997:528, § 24). Therefore, marks with a highly distinctive character, enjoy broader protection than marks with a less distinctive character (judgment of 29/09/1998, C-39/97, Canon, EU:C:1998:442, § 18).

In practice, this means that the fact that an earlier trade mark enjoys enhanced distinctive character or reputation is an argument in favour of finding likelihood of confusion.

Enhanced distinctiveness requires recognition of the mark by the relevant public. This recognition may enhance the distinctiveness of marks with little or no inherent distinctiveness or those that are inherently distinctive.

Earlier mark	Contested sign	Case No
CRISTAL		R 0037/2000-2
<p>G&S: Class 33 Territory: France Assessment of the earlier mark 'CRISTAL': 'As regards the claim that 'Cristal' is a descriptive word for the goods at issue (sparkling wines with crystalline character), the Board cannot accept it. On the one hand, it is an evocative indication which suggests the crystalline character of wines, but which in no way describes the product. On the other hand, [the Board] considers that a highly distinctive character of the mark CRISTAL on the French market had been shown' (paragraph 31)</p>		

⁵ See the Guidelines, Part C, Opposition, Section 1, Procedural Matters.

The Court has given some guidance in respect of the evaluation of distinctiveness acquired through use of the earlier mark and provided a non-exhaustive list of factors:

In making that assessment, account should be taken, in particular, of the inherent characteristics of the mark, including the fact that it does or does not contain an element descriptive of the goods or services for which it has been registered; the market share held by the mark; how intensive, geographically widespread and long-standing use of the mark has been; the amount invested by the undertaking in promoting the mark; the proportion of the relevant section of the public which, because of the mark, identifies the goods or services as originating from a particular undertaking; and statements from chambers of commerce and industry or other trade and professional associations.

(Judgment of 22/06/1999, C-342/97, Lloyd Schuhfabrik, EU:C:1999:323, § 23)

The evidence of enhanced distinctiveness acquired through use must refer to both (i) the relevant geographical area and (ii) the relevant goods and services. The opponent may claim enhanced distinctive character of the earlier mark for only part of the registered goods and services. According to the evidence submitted, the Office must establish precisely for which goods and services distinctiveness has been acquired. The nature, factors, evidence and assessment of enhanced distinctiveness are the same as for reputation. For further details on the evidence required and its assessment see the Guidelines, Part C, Opposition, Section 5, Trade Marks with Reputation (Article 8(5) CTMR).

However, a finding of reputation requires that a certain threshold of recognition be met whilst, as set out above, the threshold for a finding of enhanced distinctiveness may be lower.

Enhanced distinctiveness is anything above inherent distinctiveness.

Earlier mark	Contested sign	Case No
EL COTO	<p style="text-align: center;"><i>Coto D'Arcis</i></p> 	T-332/04
<p><i>G&S: Classes 33, 35, 39</i> <i>Territory: EU</i> <i>Assessment of the enhanced distinctiveness of the trade mark 'EL COTO':</i> The Board of Appeal took into account the market knowledge of the earlier mark 'EL COTO' and made a proper assessment of the relevant case-law principles to conclude that the earlier mark 'EL COTO' has a highly distinctive character; it based its finding on the following facts: the certificate issued by the Secretary General of the Consejo Regulador de la Denominación de Origen Calificada 'Rioja', which certifies that the owner markets its wines, among others, under the brand names 'El Coto' and 'Coto de Imaz' since 1977 and that these marks 'enjoy a significant well-known character' in Spain, various decisions of the Spanish Patent and Trade Mark Office acknowledging that the mark 'EL COTO' is well known in Spain, a document on sales evolution, indicating that they had sold under the mark 'El Coto' 339,852, 379,847, 435,857 and 464,080 boxes of twelve bottles of wine in 1995, 1996, 1997 and 1998, respectively' (paragraph 50).</p>		

Importantly, acquisition of enhanced distinctive character by a mark may be a result of its use as part of another registered trade mark (judgments of 07/07/2005, C-353/03, *Have a break*, EU:C:2005:432, § 30-32; and 07/09/2006, T-168/04, *Aire Limpio*, EU:T:2006:245, § 74).

The outcome of the examination of enhanced distinctiveness will be one of the following.

- Where there is no evidence of enhanced distinctiveness as regards the relevant goods and services or the territory, or the evidence is insufficient, the level of distinctiveness of the earlier mark will be its inherent distinctiveness (less than normal or normal).
- Where there is evidence of enhanced distinctiveness as regards all or some of the relevant goods and services and the territory, and the evidence is sufficient:
 - if the earlier mark has less than normal inherent distinctiveness, the mark/component may have acquired a normal or even a high degree of distinctiveness, depending on the evidence submitted⁶; or
 - if the earlier trade mark has normal inherent distinctiveness, it may have acquired high distinctiveness.

It must be recalled that although a mark as a whole may have acquired enhanced distinctiveness, there may be descriptive elements that will have less than normal or no distinctiveness. For example, the enhanced distinctiveness of the mark 'Coca Cola' as a whole does not alter the fact that the element 'Cola' remains entirely descriptive for certain products.

⁶ For further details on the evidence required and its assessment see the Guidelines, Part C, Opposition, Section 5, Trade Marks with Reputation (Article 8(5) CTMR).

***GUIDELINES FOR EXAMINATION IN THE
OFFICE FOR HARMONIZATION IN THE
INTERNAL MARKET (TRADE MARKS AND
DESIGNS) ON COMMUNITY TRADE MARKS***

PART C

OPPOSITION

SECTION 2

***DOUBLE IDENTITY AND
LIKELIHOOD OF CONFUSION***

CHAPTER 6

OTHER FACTORS

Table of Contents

1. Introduction.....	3
2. Family of Marks/Series of Marks	3
3. Coexistence of the Conflicting Marks on the Market in the Same Territory.....	6
3.1. Coexistence between the marks involved in the opposition.....	6
4. Incidences of Actual Confusion	8
5. Prior Decisions by Community or National Authorities Involving Conflicts Between the Same (or Similar) Trade Marks.....	9
5.1. Prior Office decisions	9
5.2. Prior national decisions and judgments.....	10
6. Irrelevant Arguments for Assessing Likelihood of Confusion	11
6.1. Specific marketing strategies	11
6.2. Reputation of CTM application	11

1. Introduction

The Office normally examines the most salient and habitually relevant factors relating to likelihood of confusion under separate headings before the chapter on Global Assessment. These factors have been treated in the preceding chapters of these Guidelines.

However, Global Assessment also takes into account **other factors, based on arguments and evidence submitted by the parties**, which are relevant for deciding on likelihood of confusion. This chapter deals with the frequent arguments/claims raised by the parties.

2. Family of Marks/Series of Marks

When an opposition to a CTM application is based on several earlier marks and those marks display characteristics that give grounds for regarding them as forming part of a single 'series' or 'family', a likelihood of confusion may be created by the possibility of association between the contested trade mark and the earlier marks forming part of the series. The Courts have given clear indications on the two cumulative conditions that have to be satisfied (judgment of 23/02/2006, T-194/03, Bainbridge, EU:T:2006:65, § 123-127, confirmed by judgment of 13/09/2007, C-234/06 P, Bainbridge, EU:C:2007:514, § 63).

- Firstly, the proprietor of a series of earlier marks must submit **proof of use** of all the marks belonging to the series or, at the very least, of a number of marks capable of constituting a 'series' (i.e. at least three).
- Secondly, the trade mark applied for must **not only be similar** to the marks belonging to the series, but must also display characteristics capable of **associating** it with the series. Association must lead the public to believe that the contested trade mark is also part of the series, that is to say, that the goods and services could originate from the same or connected undertakings. This may not be the case where, for example, the element common to the earlier series of marks is used in the contested trade mark, either in a different position from that in which it usually appears in the marks belonging to the series, or with a different semantic content.

The argument that there is a 'family of marks' must be claimed before the expiry of the **time limit set for substantiating the opposition**. The opponent must prove within the same time limit that it has used the marks forming the alleged family in the marketplace to such an extent that the relevant public has become familiar with this family of marks as designating the goods and/or services of a particular undertaking.

A positive finding that the opponent has a family of marks entails **the use of at least three marks**, the minimum threshold for such an argument to be taken into due consideration. Proof of use relating to only two trade marks cannot substantiate the existence of a series of marks.

Normally, the trade marks constituting a 'family' and used as such are all registered marks. However, it cannot be precluded that the 'family of marks' doctrine may include **non-registered trade marks** as well.

When the opponent has proven the existence of a family of marks, it would be wrong to compare the contested application individually with each of the earlier marks making up the family. Rather, the assessment of similarity **should be conducted to make a comparison between the contested mark and the family taken as a whole**, in order to establish if the contested sign displays those characteristics that are likely to trigger in the consumers' minds the association with the opponent's family of marks. In fact, an individual comparison between the conflicting signs might even lead to a finding that the signs are not sufficiently similar to lead to a likelihood of confusion, whereas the association of the contested sign with the earlier family of marks might be the decisive factor that tips the balance to a finding of likelihood of confusion.

An assumption of a family of marks on the part of the public requires that the **common denominator of the contested application and the earlier family of marks must have a distinctive character**, either *per se* or acquired through use, to allow a direct association between all of these signs. Likewise, there will be no assumption of a family of marks where the further components of the earlier signs have a greater impact in the overall impression of those signs.

Earlier signs	Contested sign	Case No
Ophtal, Crom-Ophtal, Visc-Ophtal, Pan-Ophtal	ALERGOFTAL	R 0838/2001-1
<p>G&S: Class 5 Territory: Germany Assessment: The Board held that the differences between the signs were such as to exclude the likelihood that the contested mark would be perceived as belonging to the opponent's family of marks (assuming the existence of this had been established). In particular, the Board considered that, whereas the claimed 'series' depended upon the presence in every case of the suffix '-ophtal' (and not 'oftal') preceded by a hyphen, the contested sign did not contain exactly the same suffix nor reflect exactly the same principles of construction. When 'ophtal' is combined with 'Pan-', 'Crom-' and 'Visc-', these partly disjointed prefixes become of greater distinctive value, affecting quite significantly the overall impression made by each of the marks as a whole, and in each case providing initial elements quite clearly different from the first half – 'Alerg' – of the mark applied for. The German consumer, upon seeing 'Alergoftal' would not think of dividing it into two elements, as opposed to being invited to do so when encountering marks made up of two elements separated by a hyphen (paragraphs 14 and 18).</p>		
Earlier signs	Contested sign	Case No
TIM OPHTAL, SIC OPHTAL, LAC OPHTAL etc.	OFTAL CUSI	T-160/09
<p>G&S: Class 5 Territory: EU Assessment: The element 'Ophtal', which denotes ophthalmologic preparations, is a weak element in the family of marks. The elements TIM, SIC and LAC are the distinctive elements (paragraphs 92-93).</p>		

The finding that a particular mark forms part of a family of marks requires that the **common component of the signs is identical or very similar**. The signs must contain the same distinctive element, and this element must play an independent role in the sign as a whole. Minor graphical differences in the common component may not exclude an assumption of a series of marks, when these differences may be understood by the public to be a modern presentation of the same product line. In contrast, letters that are different from or additional to the common component generally do not allow an assumption of a family of marks.

Normally, the **common element that characterises the family appears in the same position within the marks**. Therefore, the same (or very similar) element appearing in the same position in the contested sign will be a strong indicator that the later mark could be associated with the opponent's family of marks. However, the common

element appearing in a different position in the contested sign weighs heavily against such an association being established in the consumers' minds. For example, the contested sign ISENBECK is not likely to be associated with a family of BECK- marks where the element BECK is at the beginning of the signs making up the family.

Earlier signs	Contested sign	Case No
UNIZINS, UNIFONDS and UNIRAK	UNIWEB	C-317-10 P
<p>G&S: Class 36 (financial services) Territory: Germany Assessment: In this judgment the Court annulled a decision of the GC since it has not duly assessed the structure of the marks to be compared, nor the influence of the position of their common element on the perception of the relevant public (paragraph 57).</p>		

Examples where the Boards considered that a family of marks had been established:

Earlier signs	Contested sign	Case No
UniSECTOR UniSTARTUP UniSTRATEGIE	uni-gateway	R 0031/2007-1
<p>G&S: Class 36 (financial services) Territory: Germany Assessment: The Board considered that the opponent had in fact submitted sufficient evidence, by submitting, in particular, references from the relevant specialist press, such as FINANZtest, and by referring to its considerable 17.6 % market share of 'Uni' investment funds amongst German fund management companies, to show that it uses the prefix 'UNI' for a number of well-known investment funds. There is a likelihood of confusion from the point of view of the family of trade marks since the relevant trade circles would include in the series the trade mark applied for, since it is constructed in accordance with a comparable principle (paragraphs 43-44).</p>		
Earlier signs	Contested sign	Case No
UNIFIX, BRICOFIX, MULTIFIX, CONSTRUFIX, TRABAFIX, etc.	ZENTRIFIX	R 1514/2007-1
<p>G&S: Classes 1, 17 and 19 (adhesives) Territory: Spain Assessment: The Board considered that the opponent had proven the existence of a family of marks. Firstly, the Board discarded that the common element 'FIX' would be non-distinctive, given that it is not a Spanish word and even its Spanish meaning 'fijar' is not one that spontaneously comes to mind to average Spanish consumers in the context of glues and adhesives, since verbs like 'pegar', 'encolar' or 'adherir' are used more regularly in this context. Secondly, the opponent duly proved that all the marks forming the family are being used. Invoices and promotional literature duly show that goods bearing these marks are available to consumers on the market. Consumers, therefore, are aware that there is a family of marks. Thirdly, ZENTRIFIX has characteristics that replicate those of the trade marks in the family. The FIX element is placed at the end; the element that precedes it alludes to something that has some relevance to glues; the two elements are juxtaposed without any punctuation signs, dashes or physical separation; the typeface used for the two elements is the same (paragraphs 43-44).</p>		
Earlier signs	Contested sign	Case No
CITIBANK, CITIGOLD, CITICORP, CITIBOND, CITICARD, CITIEQUITY, etc.	CITIGATE	R 0821/2005-1 (confirmed by the GC T-301/09)
<p>G&S: Classes 9, 16 (potentially finance-related goods) Territory: EU Assessment: The Board considered that the evidence – consisting in particular of extracts from the</p>		

opponents' websites, annual reports, press advertisements and so forth – is littered with references to the trade marks CITICORP, CITIGROUP, CITICARD, CITIGOLD, CITIEQUITY. The evidence demonstrates that CITIBANK is in the nature of a 'house mark' or basic brand and that the opponents have developed a whole series of sub-brands based on the CITI concept. The contested mark CITIGATE is the sort of mark that the opponents might add to their portfolio of CITI marks, in particular if they wished to offer a new service to customers and place the emphasis on the idea of access (paragraphs 23-24).

3. Coexistence of the Conflicting Marks on the Market in the Same Territory

The CTM applicant may claim that the conflicting trade marks coexist in the relevant territory. Usually the coexistence argument comes up when the applicant owns a national trade mark corresponding to the CTM application in the territory where the opposing trade mark is protected. The applicant may also refer to coexistence with a trade mark owned by a third party.

Therefore, two different situations, both referred to as 'coexistence' by the parties, should be distinguished:

- coexistence between the two marks involved in the opposition can be persuasive of the absence of a likelihood of confusion in the relevant public's perception (see below);
- where many similar marks (other than the two marks involved in the opposition) are used by competitors, the coexistence may affect the scope of protection of the earlier right. See the Guidelines, Part C, Opposition, Section 2, Double Identity and Likelihood of Confusion, Chapter 5, Distinctiveness of the Earlier Mark.

3.1. Coexistence between the marks involved in the opposition

In opposition proceedings, it is most commonly argued by the CTM applicant that the conflicting marks coexist on a national level and that the coexistence is tolerated by the opponent. Occasionally, it is argued that coexistence is accepted by the parties in a coexistence agreement.

The possibility cannot be ruled out that the coexistence of two marks on a particular market might, together with other elements, contribute to diminishing the likelihood of confusion between those marks on the part of the relevant public (judgment of 03/09/2009, C-498/07P, La Española, EU:C:2013:302, § 82). In certain cases, the coexistence of earlier marks in the market could reduce the likelihood of confusion that the Office finds between two conflicting marks (judgment of 11/05/2005, T-31/03, Grupo Sada, EU:T:2005:169, § 86).

However, the indicative value of coexistence should be treated with **caution**. There might be different reasons why the two signs coexist on a national level, e.g. a different legal or factual situation in the past or prior rights agreements between the parties involved.

Therefore, whilst the impact of coexistence on the finding of likelihood of confusion is accepted in theory, the conditions for this coexistence to be persuasive of the absence of a risk of confusion are, in practice, very difficult to establish and seldom prevail.

For the CTM applicant to prove that the coexistence was based upon the absence of any likelihood of confusion on the part of the relevant public certain conditions must be met.

- **Comparable situation.** The earlier ('co-existing') marks and the marks at issue are **identical** to those involved in the opposition before the Office (judgments of 11/05/2005, T-31/03, Grupo Sada, EU:T:2005:169, § 86; 18/09/2012, T-460/11, Bürger, EU:T:2012:432, § 60-61) and cover the same goods or services as those in conflict (decision of 30/03/2010, R 1021/2009-1, Eclipse, § 14).
- The coexistence concerns the **countries** relevant in the case (e.g. alleged coexistence in Denmark is irrelevant when the opposition is based on a Spanish trade mark; judgment of 13/07/2005, T-40/03, Julián Murúa Entrena, EU:T:2005:285, § 85). If the earlier trade mark is a CTM, the CTM applicant must show coexistence in the entire EU.
- Only the coexistence in the **marketplace** can be taken into account. The mere fact that both trade marks exist in the national register (formal coexistence) is insufficient. The CTM applicant has to prove that the trade marks were **actually used** (decision of 13/04/2010, R 1094/2009-2, Business Royals, § 34). Coexistence should be understood as 'co-use' of concurrent and supposedly conflicting marks (decisions of 08/01/2002, R 0360/2000-4, No Limits, § 13; 05/09/2002, R 0001/2002-3, Chee.Tos, § 22).
- The **period of coexistence** must be taken into consideration: in the judgment of 01/03/2005, T-185/03, 'Enzo Fusco', the alleged coexistence of only four months was considered obviously too short. Moreover, the coexistence of the trade marks has to relate to a period close to the filing date of the CTM application (decision of 12/05/2010, R 0607/2009-1, Elsa Zanella, § 39).
- The absence of a likelihood of confusion may be only inferred from the '**peaceful**' nature of the coexistence of the marks at issue on the market concerned (judgments of 03/09/2009, C-498/07P, La Española, EU:C:2013:302, § 82; 08/12/2005, T-29/04, Cristal Castellblanch, EU:T:2005:438, § 74; 24/11/2005, T-346/04, Arthur et Félicie, EU:T:2005:420, § 64). This is not the case when the conflict has been an issue before the national courts or administrative bodies (infringement cases, oppositions or applications for annulment of a trade mark).
- Moreover, the peaceful coexistence of the trade marks in the relevant national market does not outweigh the likelihood of confusion if it is based on prior right agreements between the parties including agreements settling disputes before national courts, since these agreements, even if based on the assessment of the legal situation made by the parties, may have purely economic or strategic reasons.

However, exceptional situations are possible. In its preliminary ruling of 22/09/2011, C-482/09, Budweiser, EU:C:2011:605, the Court of Justice ruled that two identical trade marks designating identical goods can coexist on the market to the extent that there has been a long period of **honest concurrent use** of those trade marks and that use neither has nor is liable to have an adverse effect on the essential function of the trade mark which is to guarantee consumers the origin of the goods and services.

As regards **coexistence agreements** between the parties, when assessing likelihood of confusion the Office's policy is that these agreements may be taken into account like any other relevant factor, but they are **in no way binding for the Office**. This is particularly true when the application of the relevant provisions of the CTMR and the established case-law lead to a conclusion that is not in accordance with the content of the agreement.

If an agreement is disputed before national instances or there are pending court proceedings and the Office estimates that the outcome could be relevant for the case at issue, it may decide to suspend the proceedings.

In addition, as a general rule, nothing precludes the opponent from filing an opposition against a CTM application, whether or not it previously opposed other (national) marks of the applicant. This cannot be considered as 'contradictory behaviour' and interpreted to the opponent's disadvantage, especially since in the opposition proceedings, unlike the invalidity proceedings, the defence of 'acquiescence' is not available (the rules for opposition proceedings do not contain an equivalent to Article 54 CTMR, according to which a CTM proprietor may invoke as a defence the fact that the applicant for invalidity has acquiesced to the use of the CTM for more than five years).

4. Incidences of Actual Confusion

Likelihood of confusion means a probability of confusion on the part of the relevant consumer and does not require actual confusion. As expressly confirmed by the Court: '... it is not necessary to establish the existence of actual confusion, but the existence of a likelihood of confusion' (judgment of 24/11/2005, T-346/04, Arthur et Félicie, EU:T:2005:420, § 69).

In the global assessment of likelihood of confusion all relevant factors have to be taken into consideration. Evidence of actual confusion is a factor that may weigh in favour of likelihood of confusion; its indicative value should not, however, be overestimated for the following reasons:

- in everyday life there are always people who confuse and misconstrue everything, and others who are extremely observant and very familiar with every trade mark. Therefore, there is no legal value in highlighting the existence of these people since it could lead to subjective results;
- insofar as the targeted consumer's perception is concerned, the assessment is normative. The average consumer is assumed to be 'reasonably well-informed and reasonably observant and circumspect', even though in purely factual terms some consumers are extremely observant and well-informed, whilst others are careless and credulous (decision of 10/07/2007, R 0040/2006-4, SDZ Direct World, § 32).

Therefore, incidences of actual confusion can influence the finding of likelihood of confusion only if it is proven that these incidences usually accompany the existence of the conflicting trade marks in the market in the typical situation in trade involving the goods and/or services concerned.

To properly weigh evidence on the number of occasions when actual confusion has arisen, the assessment must be made in the light of the number of opportunities for confusion. If the business transactions are voluminous but the instances of confusion

are sparse, this evidence will have little weight in the assessment of likelihood of confusion.

Lack of actual confusion has been treated in the context of coexistence, in paragraph 4 above.

5. Prior Decisions by Community or National Authorities Involving Conflicts Between the Same (or Similar) Trade Marks

5.1. Prior Office decisions

As regards previous decisions of the Office in conflicts between identical or similar trade marks, the General Court has stated that:

... it is settled case-law ... that the legality of the decisions of the [Office] is to be assessed purely by reference to [the CTMR] and not the Office's practice in earlier decisions.

(Judgment of 30/06/2004, T-281/02, Mehr für Ihr Geld, EU:T:2004:198, § 35.)

Accordingly, the Office is **not bound by its previous decisions**, since each case has to be dealt with separately and with regard to its particularities.

Notwithstanding the fact that previous decisions of the Office are not binding, their reasoning and outcome should still be **duly considered** when deciding upon the case in question. This was reinforced in the judgment of 10/03/2011, C-51/10 P, 1000, EU:C:2011:139, § 73-75:

The Office is under a duty to exercise its powers in accordance with the general principles of European Union law, such as the principle of equal treatment and the principle of sound administration.

In the light of those two principles, the Office must, when examining an application for registration of a Community trade mark, take into account the decisions already taken in respect of similar applications and consider with special care whether it should decide in the same way or not ...

That said, the way in which the principles of equal treatment and sound administration are applied must be consistent with respect for legality.



The indicative value of the previous decisions will in principle be limited to cases that bear a sufficiently close resemblance to the case in question. However, according to Article 76(1) CTMR, in opposition proceedings the Office shall be restricted in the examination of the case to the facts, evidence and arguments submitted by the parties. For this reason, even in cases based on comparable facts and involving similar legal problems, the outcome may still vary due to the different submissions made by the parties and the evidence they present.

5.2. Prior national decisions and judgments

Decisions of national courts and of national offices in cases regarding conflicts between identical or similar trade marks on the national level **do not have a binding effect** on the Office. According to case-law, the Community trade mark regime is an autonomous system with its own set of objectives and rules peculiar to it and applies independently of any national system. Accordingly, the registrability of a sign as a Community trade mark is to be assessed on the basis of the relevant legislation alone (judgments of 13/09/2010, T-292/08, *Often*, EU:T:2010:399, § 84; 25/10/2006, T-13/05, *Oda*, EU:T:2006:335, § 59).

Therefore, the decisions adopted in a Member State or in a State that is not a member of the European Union are not binding for the Office (judgment of 24/03/2010, T-363/08, *Nollie*, EU:T:2010:114, § 52).

Still, their reasoning and outcome should be **duly considered**, particularly when the decision has been taken in the Member State that is relevant to the proceedings. National courts have a thorough knowledge of the specific characteristics of their Member State, in particular as regards the marketplace reality in which goods and services are marketed and the customer perception of signs. This may, in particular cases, be relevant for the assessment made by the Office.

Earlier sign	Contested sign	Case No
MURUA		T-40/03
<p>G&S: Class 33 Territory: Spain Assessment: The Court took into consideration the reasoning of a judgment of the national court as far as it explained the perception of family names on the part of the public in the relevant country: regarding the question whether the relevant public in Spain will generally pay greater attention to the surname 'Murúa' than to the surname 'Entrena' in the trade mark applied for, the Court considers that, while it is <u>not binding</u> on Community bodies, Spanish case-law can provide <u>a helpful source of guidance</u> (paragraph 69).</p>		
Earlier sign	Contested sign	Case No
	OFTEN	T-292/08
<p>G&S: Class 14 Territory: Spain Assessment: The Court did not see the relevance of Spanish case-law, according to which an average member of the Spanish public has some knowledge of English for the assessment of the particular case:</p> <p style="padding-left: 40px;">In the present case, the applicant has not put forward any factual or legal consideration, deriving from the national case-law relied upon, which is capable of providing helpful guidance for determination of the case ... The mere finding that certain English words are known to the Spanish consumer, namely the words 'master', 'easy' and 'food', even if that is clear from the national case-law in question, cannot lead to the same conclusion as regards the word 'often' (paragraph 85).</p>		

Whilst it is, in principle, permissible to take into account decisions of national courts and authorities, these decisions should be examined **with all the required care and in a diligent manner** (judgment of 15/07/2011, T-108/08, Good Life, EU:T:2011:391, § 23). Usually the understanding of such a decision will require the submission of sufficient information, in particular about the facts on which the decision was based. Their indicative value will, therefore, be limited to the rare cases when the factual and legal background of the case was presented completely in the opposition proceedings and is conclusive, clear and not disputed by the parties.

The above guidelines are without prejudice to the effects of the judgments of Community trade mark courts dealing with counterclaims for revocation or for a declaration of invalidity of CTMs.

6. Irrelevant Arguments for Assessing Likelihood of Confusion

6.1. Specific marketing strategies

The examination of the likelihood of confusion carried out by the Office is a prospective examination. In contrast to trade mark infringement situations – where the courts deal with specific circumstances in which the particular facts and the specific nature of use of the trade mark are crucial – the deliberations of the Office on likelihood of confusion are carried out in a more abstract manner.

For this reason, specific marketing strategies are not relevant. The Office must take the usual circumstances in which the goods covered by the marks are marketed as its benchmark, that is, those circumstances that are expected for the category of goods covered by the marks. The particular circumstances in which the goods covered by the marks are actually marketed have, as a matter of principle, no impact on the assessment of the likelihood of confusion because they may vary in time depending on the wishes of the proprietors of the trade marks (judgments of 15/03/2007, C-171/06 P, Quantum, EU:C:2007:171, § 59; 22/03/2012, C-354/11 P, G, EU:C:2012:167, § 73; 21/06/2012, T-276/09, Yakut, EU:T:2012:313, § 58).

For example, the fact that one party offers its everyday consumer goods (wines) for sale at a higher price than competitors is a purely subjective marketing factor that is, as such, irrelevant when assessing the likelihood of confusion (judgment of 14/11/2007, T-101/06, Castell del Remei Oda, EU:T:2007:340, § 52).

6.2. Reputation of CTM application

Applicants sometimes argue that there will be no likelihood of confusion with the earlier mark because the CTM application has a reputation. This argument cannot prosper because the right to a CTM begins on the date when the CTM application is filed and not before, and it is from that date onwards that the CTM has to be examined with regard to opposition proceedings. Therefore, when considering whether or not the CTM falls under any of the relative grounds for refusal, events or facts that happened before the filing date of the CTM are irrelevant because the opponent's rights, insofar as they predate the CTM, are earlier than the applicant's CTM.

***GUIDELINES FOR EXAMINATION IN THE
OFFICE FOR HARMONIZATION IN THE
INTERNAL MARKET (TRADE MARKS AND
DESIGNS) ON COMMUNITY TRADE MARKS***

PART C

OPPOSITION

SECTION 2

***DOUBLE IDENTITY AND
LIKELIHOOD OF CONFUSION***

CHAPTER 7

GLOBAL ASSESSMENT

Table of Contents

1	Introduction	3
1.1	Nature of global assessment	3
2	Interdependence Principle	3
3	Imperfect Recollection	4
4	Impact of the Method of Purchase of Goods and Services	4
4.1	Visual similarity	5
4.2	Aural similarity	7
4.3	Conclusion	8
5	Impact of the Conceptual Similarity of the Signs on Likelihood of Confusion	8
6	Impact on Likelihood of Confusion of Components that are Non-distinctive or Distinctive only to a Low Degree	10
6.1	Common components with low distinctiveness	10
6.2.	Common components with no distinctiveness	12
7	Specific Cases	13
7.1	Short signs	13
7.2	Name/Surnames	14
7.2.1	Names	14
7.2.2	Business names in combination with other components	14
7.2.3	First and family names	14
7.3	Colour marks per se	19

1 Introduction

1.1 Nature of global assessment

A likelihood of confusion (including a likelihood of association) exists if there is a risk that the public might believe that the goods or services in question, under the assumption that they bear the marks in question, come from the same undertaking or, as the case may be, from economically-linked undertakings. If a significant part of the relevant public of the goods or services at issue may be confused as to the origin of the goods or services, this is sufficient. Therefore, there is no need to establish that all actual or potential consumers of the relevant goods or services are likely to be confused.

The Court has stated that likelihood of confusion must be appreciated globally, taking into account all the factors relevant to the circumstances of the case; this appreciation depends on numerous elements and, in particular, on the degree of recognition of the mark on the market, the association that the public might make between the two marks and the degree of similarity between the signs and the goods and services (judgment of 11/11/1997, C-251/95, Sabèl, EU:C:1997:528, § 22).

The Office normally examines the most salient and habitually relevant factors relating to likelihood of confusion and establishes their degrees:

- (i) similarity of goods and services;
- (ii) the relevant public and the level of attention;
- (iii) similarity of the signs taking into account their distinctive and dominant elements;
- (iv) the distinctiveness of the earlier mark.

In the last section of a decision containing the global assessment, those factors are weighed up. However, the global assessment can weigh up many other factors that are relevant to deciding on likelihood of confusion (see Chapter 6, 'Other Factors').

2 Interdependence Principle

The Court has set out the essential principle that evaluating likelihood of confusion implies some **interdependence between the relevant factors** and, in particular, between the previously established findings on the degree of similarity between the marks and that between the goods or services. Therefore, a lesser degree of similarity between goods and services may be offset by a greater degree of similarity between the marks and vice versa (judgment of 29/09/1998, C-39/97, Canon, EU:C:1998:442, § 17). This principle of interdependence is crucial to the analysis of likelihood of confusion.

The interdependence of those factors is expressly referred to in recital 8 in the preamble to the CTMR, according to which the concept of similarity is to be interpreted in relation to the likelihood of confusion, the assessment of which depends on numerous elements and, in particular, on the recognition of the mark on the market, the association that can be made with the used or registered sign, the degree of similarity between the mark and the sign and that between the goods or services identified (judgment of 10/09/2008, T-325/06, Capio, EU:T:2008:338, § 72 and the case-law cited).

The requirement for a global appreciation and the principle of interdependence means that where there is at least some degree of similarity between the signs and the relevant goods/services, there will be an assessment of likelihood of confusion involving an iterative process that weighs up all the relevant factors. This process takes place in the global assessment section.

In practice, this means that the **Office will weigh up**, inter alia, the degree of similarity between the goods and services and the degree of attention paid by the relevant public to those goods and services, the degree of similarity between the signs, and whether the impression produced by any one of the levels of comparison (visual/aural/conceptual) is more important, and the distinctiveness of the earlier mark

Moreover, the factors evaluated in the global assessment **will vary** according to the particular circumstances. For example, in clear-cut cases where goods/services and the signs are highly similar or identical, the Office may find a likelihood of confusion without assessing all factors – such as enhanced distinctiveness, family of marks, etc.

Importantly, it is not possible to set out in the abstract whether one factor carries more weight than another because these factors will have varying degrees of relative importance depending on the circumstances. For instance, the degree of visual similarity may weigh more heavily in connection with goods that are usually examined visually, whilst the degree of aural similarity may be more relevant to goods normally ordered orally.

3 Imperfect Recollection

Although, the average consumer of the category of products concerned is deemed to be reasonably well-informed and reasonably observant and circumspect, account is taken of the fact that the average consumer only rarely has the chance to make a direct comparison between the different marks and must place trust in the imperfect picture of them that he or she has kept in mind. It should also be borne in mind that the average consumer's level of attention is likely to vary according to the category of goods or services in question (judgment of 22/06/1999, C-342/97, Lloyd Schuhfabrik, EU:C:1999:323, § 26). Even consumers with a high level of attention need to rely on their imperfect recollection of trade marks (judgment of 21/11/2013, T-443/12, ancotel, EU:T:2013:605, § 54).

4 Impact of the Method of Purchase of Goods and Services

The Court has stated that, when evaluating the importance attached to the degree of visual, aural and conceptual similarity between the signs, it is appropriate to take into account the category of goods or services in question and the way they are marketed (judgment of 22/09/1999, C-342/97, Lloyd Schuhfabrik, EU:C:1999:323, § 27).

The category of goods and services involved may increase the importance of one of the different aspects of similarity between signs (visual, phonetic and conceptual) because of how goods and services are ordered and/or purchased. An aural or conceptual comparison between signs may be less important in the case of goods and services that are usually examined visually or may be tried on before being bought. In such cases, the visual impression of signs counts more in the assessment of likelihood of confusion.

However, it is important to emphasise that, as with all of the factors that are relevant to likelihood of confusion, the factors are interlinked and each set of circumstances must be examined on a case-by-case basis. This means that no general rule should be applied to broad categories of goods or services.

4.1 Visual similarity

A good example of where visual similarity can play a greater – but not an exclusive – role in the global assessment of the likelihood of confusion is clothing. Generally, in clothing shops, customers can either choose the clothes they wish to buy themselves or be assisted by the sales staff. Whilst oral communication in respect of the product and the trade mark is not excluded, the choice of the item of clothing is generally made visually. Therefore, visual perception of the marks in question will generally take place prior to purchase. Accordingly, the visual aspect plays a greater role in the global assessment of the likelihood of confusion (judgments of 14/10/2003, T-292/01, Bass, EU:T:2003:264, § 55; 06/10/2004, T-117/03-T-119/03 & T-171/03, NL, EU:T:2004:293, § 50; 18/05/2011, T-502/07, McKenzie, EU:T:2011:223, § 50; 24/01/2012, T-593/10, B, EU:T:2012:25, § 47). These considerations played a role in finding no likelihood of confusion between the marks below for, *inter alia*, certain goods in Class 25.

Earlier sign	Contested sign	Case No
		T-502/07
		T-593/10

The same considerations were central to a finding of likelihood of confusion in the following cases also for, *inter alia*, certain goods in Class 25.

Earlier sign	Contested sign	Case No
		R 1050/2008-4
PETER STORM	PEERSTORM	T-30/09
		T-376/09

However, granting preferential consideration to the visual perception does not mean that identical verbal elements can be overlooked due to the presence of striking

figurative elements, as can be seen in the case below, where likelihood of confusion was found for goods in Class 25.

Earlier sign	Contested sign	Case No
	FISHBONE	T-415/09 (appeal dismissed C-621/11P)

In a similar way, the visual impression for marks covering video **games** has also been held to be particularly relevant because these goods are normally purchased after a comprehensive examination of their respective specifications and technical characteristics, firstly upon the basis of information that appears in specialist catalogues or on the internet, and then at the point of sale. For these reasons, the visual differences were key to the finding of no likelihood of confusion below (judgment of 08/09/2011, T-525/09, Metronia, EU:T:2011:437, § 38-47).

Earlier sign	Contested sign	Case No
		T-525/09

The visual similarity between signs may also have an increased importance where the goods are **ordinary consumer products (e.g. goods in Classes 29 and 30)** that are most commonly purchased in supermarkets or establishments where goods are arranged on shelves and where consumers are guided more by the visual impact of the mark they are looking for. Consequently, for such goods the visual differences were central to a finding of no likelihood of confusion in the UK between the marks below.

Earlier sign	Contested sign	Case No
	EGLÉFRUIT	T-488/07

However, the broad principle above does not mean that for goods that are normally purchased visually, the phonetic impression can be overlooked. This latter point was highlighted in a case involving the marks below where the General Court, confirming the finding of a likelihood of confusion, held that although **computers and computer accessories** are sold to consumers 'as seen' on shelves in self-service areas, the phonetic identity between the marks at issue was, in this case, at least as important as their visual similarity because an oral discussion of the characteristics of the goods and their mark is also likely to take place at the time of purchase. Furthermore, those goods could be advertised orally, on radio or by other consumers.

Earlier sign	Contested sign	Case No
CMORE		T-501/08

4.2 Aural similarity

In contrast to the cases above, where visual similarity played a stronger role, similarity on the phonetic level may have more weight than similarity on the visual level when the goods at issue are traditionally ordered orally. This consideration came into play in the finding of likelihood of confusion in the case below, which dealt with **vehicle rental and associated services**, which are recommended and chosen orally in a significant number of cases.

Earlier sign	Contested sign	Case No
CICAR	ZIPCAR	T-36/07

Where goods are ordered orally, the phonetic perception of the sign may also be influenced by factors such as the likely presence of various other sounds perceived by the recipient of the order at the same time. Such considerations are relevant where the goods in question are normally ordered at sales points with an increased noise factor, such as **bars or nightclubs**. In such cases, attaching particular importance to the phonetic similarity between the signs at issue may be appropriate. These considerations came into play in the finding of likelihood of confusion between the marks below for certain goods in Class 33 (judgment of 15/01/2003, T-99/01, *Mystery*, EU:T:2003:7, § 48).

Earlier sign	Contested sign	Case No
MIXERY		T-99/01

Similarly, a particular method or customary way of ordering goods may mean increased importance being attributed to the phonetic similarity between the signs. For instance, the General Court has held that in the **wines sector**, consumers usually describe and recognise wine by reference to the verbal element that identifies it, in particular in bars and restaurants, in which wines are ordered orally after their names have been seen on the wine list (judgments of 23/11/2010, T-35/08, *Artesa Napa Valley*, EU:T:2010:476, § 62; 13/07/2005, T-40/03, *Julián Murúa Entrena*, EU:T:2005:285, § 56; 12/03/2008, T-332/04, *Coto d’Arcis*, EU:T:2008:69, § 38). Accordingly, in such cases, it may be appropriate to attach particular importance to the phonetic similarity between the signs at issue. These considerations came into play in the finding of likelihood of confusion between the marks below for wine despite their considerable visual differences.

Earlier sign	Contested sign	Case No
<p>MURÚA</p>		<p>T-40/03</p>
		<p>T-35/08</p>

Nevertheless, the broad principle above does not mean that the visual impression can be overlooked for goods normally purchased orally. Indeed, the General Court has held that although preponderant importance had sometimes been accorded to the phonetic perception of marks for beverages, the phonetic dissimilarities of the marks did not merit particular importance where the specific beverages were widely distributed and sold not only in specialist shops, where they would be ordered orally, but in large shopping centres as well, where they would be purchased visually (judgment of 03/09/2010, T-472/08, 61 a nossa alegria, EU:T:2010:347, § 106).



4.3 Conclusion

The circumstances set out above demonstrate that in certain situations the Office should grant preferential consideration to the visual or aural perception of marks depending on how the goods and services at issue are ordered or purchased. However, even in these situations identical or highly similar visual or aural elements cannot be entirely overlooked because all the relevant factors are interlinked and interdependent, and each set of circumstances must be examined on a case-by-case basis.

5 Impact of the Conceptual Similarity of the Signs on Likelihood of Confusion

A conceptual *similarity* between signs with *analogous* semantic content may give rise to a likelihood of confusion where the earlier mark is particularly distinctive (judgment of 11/11/1997, C-251/95, Sabèl, EU:C:1997:528, § 24, where the signs shared the broader concept of a 'bounding feline', but did not evoke the same animal: a puma in the earlier mark and a cheetah in the contested mark).

However, exceptionally, where the signs have the *same* distinctive concept in common accompanied by visual similarities between the signs, this may lead to a likelihood of confusion even in the absence of a particularly high distinctiveness of the earlier mark, as illustrated by the following example.

Earlier sign	Contested sign	Case No
		<p>Joined Cases T-81/03, T-82/03 and T-103/03</p>
<p>G&S: Classes 32, 33 <i>Territory:</i> Spain (where 'venado' means 'deer') <i>Assessment:</i> The Court found that the signs had the same concept and that there was significant visual similarity. In the absence of a clear semantic link between a deer or a deer's head and alcoholic or non-alcoholic beverages, the Court found it impossible to deny that the concept of a deer's head portrayed facing forward inside a circle had at least average distinctive character for designating beverages (para. 110.). Enhanced distinctiveness was not considered – likelihood of confusion (for the Spanish public).</p>		

A conceptual similarity between the signs may not be sufficient to outweigh the visual and phonetic differences, where the concept in common is non-distinctive.

Earlier sign	Contested sign	Case No
<p>K2 SPORTS</p>		<p>T-54/12</p>
<p>G&S: Classes 18, 25, 28 <i>Territory:</i> Germany and the UK <i>Assessment:</i> Contrary to the Board's finding that there is no conceptual similarity, the term 'sport', notwithstanding its descriptive character, refers to the same concept and leads to the conclusion that there is a degree of conceptual similarity. The Court concluded that this similarity was weak in the context of the overall impression of the signs and in particular of the very weak distinctive character of this term. However, the weak conceptual similarity did not offset the significant visual and phonetic differences between the signs (para. 49) – no likelihood of confusion.</p>		

According to case-law, the conceptual differences between signs may counteract their visual and phonetic similarity (judgment of 12/01/2006, C-361/04, PICARO, ECLI:EU:C:2006:25, § 20). According to Office practice, when a similarity is found in one aspect (visual/phonetic/conceptual), the examination of likelihood of confusion must continue¹. Therefore, the question whether the conceptual dissimilarity is sufficient to counteract the visual and/or phonetic similarity between the marks has to be examined in the global assessment of the likelihood of confusion. Furthermore, as explained above in Chapter 4, 'Comparison of signs', paragraph 3.4.4, the conceptual

¹ See the Guidelines, Part C, Opposition, Section 2, Double Identity and Likelihood of Confusion, Chapter 4, Comparison of Signs, paragraph 1.3.

dissimilarity can be found only if each trade mark has a clear concept that may be immediately grasped by the public and these concepts are different.

The conceptual difference between the signs may not be sufficient to neutralise the visual and phonetic similarities.

Earlier sign	Contested sign	Case No
MUNDICOLOR	MUNDICOR	Joined Cases T-183/02 and T-184/02
<p>G&S: Class 2 Territory: Spain Assessment: Whilst 'MUNDICOLOR' is to a certain extent evocative of 'colours of the world' or 'the world in colours' for the Spanish public, it cannot be regarded as having any clear and specific meaning. In the mark applied for, the same prefix is accompanied by the suffix 'cor', a term which has no meaning in the Spanish language. Therefore, notwithstanding the evocative nature of the prefix 'mundi' (world), the latter is ultimately devoid of any concept for that public. As neither of the signs has a clear and specific meaning likely to be grasped immediately by the public, any conceptual difference between them is not such as to counteract their visual and aural similarities (paras 90-99) – likelihood of confusion.</p>		

The finding of conceptual similarity must therefore be followed by a careful assessment of the inherent and acquired distinctiveness of the earlier trade mark.

6 Impact on Likelihood of Confusion of Components that are Non-distinctive or Distinctive only to a Low Degree

When assessing the similarity of the signs, an analysis of whether the coinciding components are descriptive, allusive or otherwise weak is carried out in order to calculate the extent to which these coinciding components have a lesser or greater capacity to indicate commercial origin. It may be more difficult to establish that the public may be confused as to origin due to similarities that solely pertain to or non-distinctive elements.²

The Office and a number of trade mark offices of the European Union have agreed on a **Common Practice** under the European Trade Mark and Designs Network with regard to the impact on likelihood of confusion of components that are non-distinctive or Distinctive only to a low degree.

6.1 Common components with low distinctiveness

According to the Common Practice, when the marks share an element with **low distinctiveness**, the assessment of likelihood of confusion will focus on the impact of the non-coinciding components on the overall impression of the marks. The assessment will take into account the similarities/differences and distinctiveness of the non-coinciding components.



² See the Guidelines, Part C, Opposition, Section 2, Double Identity and Likelihood of Confusion, Chapter 5, Distinctiveness of the earlier mark.

A coincidence in an element with a low degree of distinctiveness **will not normally on its own lead to likelihood of confusion**. However, there may be likelihood of confusion if the other components are of a lower (or equally low) degree of distinctiveness or are of insignificant visual impact and the overall impression of the marks is similar. There may also be likelihood of confusion if the overall impression of the marks is highly similar or identical.

The following are examples agreed in the context of the Common Practice, where the common component(s) is/are considered to possess a low degree of distinctiveness³.

Earlier mark	Contested mark	Goods/services	Outcome
MORELUX	INLUX	Class 44: Beauty Treatment	No likelihood of confusion
DURALUX	VITALUX	Class 44: Beauty Treatment	No likelihood of confusion
		Class 32: Fruit juices	No likelihood of confusion
		Class 9: Credit cards	No likelihood of confusion
		Class 32: Fruit juices	No likelihood of confusion
		Class 30: Tea	No likelihood of confusion
		Class 9: Credit cards	No likelihood of confusion
COSMEGLOW	COSMESHOW	Class 3: Cosmetics	Likelihood of confusion
		Class 11: Refrigerators	Likelihood of confusion

³ For the purposes of the Common Practice, all the other factors that may be relevant for the global appreciation of likelihood of confusion are deemed not to affect the outcome. It is also considered that the goods and services are identical.

		Class 43: Holiday accommodation services	Likelihood of confusion
---	---	--	-------------------------

6.2. Common components with no distinctiveness



According to the Common Practice, when marks share an element with **no distinctiveness**, the assessment of likelihood of confusion will focus on the impact of the non-coinciding components on the overall impression of the marks. The assessment will take into account the similarities/differences and distinctiveness of the non-coinciding components.

A coincidence only in non-distinctive components **does not lead to likelihood of confusion**. However, when marks also contain other figurative and/or word elements that are similar, there will be likelihood of confusion if the overall impression of the marks is highly similar or identical.

The following are examples agreed in the context of the Common Practice, where the common component(s) is/are considered to possess no distinctiveness⁴.

Earlier mark	Contested mark	Goods/services	Outcome
GREENGRO	GREENFLUX	Class 19: Building materials Class 37: Construction services	No likelihood of confusion
BUILDGRO	BUILDFLUX	Class 19: Building Materials Class 37: Construction Services	No likelihood of confusion
	SMARTPHONES.NET	Class 9: Mobile phones	No likelihood of confusion
		Class 36: Financial Services	No likelihood of confusion
		Class 29: Fish	No likelihood of confusion

⁴ For the purposes of the Common Practice, all the other factors that may be relevant for the global appreciation of likelihood of confusion are deemed not to affect the outcome. It is also considered that the goods and services are identical.

CRE-ART	PRE-ART	Class 41: Art gallery services	Likelihood of confusion
TRADENERGY	TRACENERGY	Class 9: Solar energy collectors for electricity generation	Likelihood of confusion
		Class 9: Solar energy collectors for electricity generation	Likelihood of confusion

7 Specific Cases

7.1 Short signs

As indicated before, the Courts have not exactly defined what a short sign is. However, signs with three or fewer letters/numbers are considered by the Office as short signs.

It should be noted that the General Court held that the global assessment of the likelihood of confusion between signs consisting of a single letter (or a combination of letters not recognisable as a word) **follows the same rules** as that in respect of word signs comprising a word, a name or an invented term (judgments of 06/10/2004, T-117/03-T-119/03 and T-71/03, NL, EU:T:2004:293, § 47-48, and 10/05/2011, T-187/10, G, EU:T:2011:202, § 49).

In the assessment of the likelihood of confusion it is important to establish the degree of **inherent distinctiveness** of the earlier trade mark, and therefore its scope of protection. See in this respect Chapter 5 of this Section, Distinctiveness of the earlier mark, and the specific section on short signs.

As to the overall assessment of likelihood of confusion, the Court made it clear that the fact that two trade marks consisting of the same letter (or of the same sequence of letters) are found to be identical from an aural and a conceptual point of view is relevant when it comes to assessing the existence of a likelihood of confusion. In such cases, it is only when the later trade mark causes a **sufficiently different visual impression** that a likelihood of confusion can be safely ruled out (judgment of T-187/10, G, EU:T:2011:202, § 60).

Consequently, a likelihood of confusion can be safely excluded when two conflicting signs, albeit containing or consisting of the same single letter or a combination of letters not recognisable as a word, are stylised in a sufficiently different way or contain a sufficiently different figurative element, so that their different overall graphical representation eclipses the common verbal element.

Where the opponent has successfully proven that its earlier mark has acquired enhanced distinctiveness through intensive use or reputation, the impact thereof on the final outcome has to be carefully assessed. Firstly, enhanced distinctiveness on the part of an earlier mark containing or consisting of a single letter or a combination of letters cannot justify a finding of a likelihood of confusion if the overall visual impression of the signs is so different as to safely set them apart. Secondly, if the evidence shows

use of a single letter or combination of letters stylised or accompanied by additional figurative elements, the benefit of the resulting broader scope of protection accrues to the form in which it was used and not to the single letter as such or any other stylised variation.

7.2 Name/Surnames

7.2.1 Names



In principle, there are no specific criteria to be taken into account when likelihood of confusion between names is assessed. However, because of the very nature of names and surnames, there are certain aspects that come into play (as we shall see below), such as whether a given name and/or surname is common or not in the relevant territory, that have to be carefully considered and balanced.

7.2.2 Business names in combination with other components

When assessing likelihood of confusion in relation to composite signs that contain several verbal elements, one of which might be seen as being a business name, i.e. indicating the company ‘behind’ the trade mark, an overall assessment must be done in order to identify which element functions as the trade mark of the goods and services concerned. Factors to be taken into account include the distinctiveness of each element as well as the size and/or space they occupy in a figurative mark, which determine the dominant element of the conflicting signs.

Where the business name is not the dominant element, although each of the elements making up the sign might have their own independent distinctive role, consumers are likely to focus more on the element that would be seen as identifying the specific product line rather than on the element that would be perceived (because it is preceded by ‘by’ or another equivalent term) as identifying either the company who has control of the products concerned or the designer who created the product line.

Therefore, whenever there is a sufficient degree of similarity between the component that would be perceived as the trade mark and a conflicting sign, in principle there will be likelihood of confusion (provided the other relevant factors are met).

Earlier sign	Contested sign	Case No
		T-43/05
<p>G&S: Class 25 Territory: Denmark, Finland, Sweden Assessment: ‘The element “by CAMPER” will be perceived as subsidiary, also due to the fact that the relevant public will perceive it as a mere indication of the undertaking producing the goods in question.’ Therefore, the relevant consumer will focus their attention on the word ‘BROTHERS’ and might attribute a common origin to the goods concerned (paras 65 and 86) – likelihood of confusion.</p>		

7.2.3 First and family names

The perception of signs made up of personal names may vary from country to country within the European Union. Family names have, in principle, a higher intrinsic value as

indicators of the origin of goods or services than first names. This is because common experience shows that the same first names may belong to a great number of people who have nothing in common, whereas the presence of the same surname (provided it is not common in the relevant territory) could imply the existence of some link between them (identity of the persons or a family link). In determining whether, in a particular country, the relevant public generally attributes greater distinctiveness to the surname than the forename, the case-law of that country, although not binding on the Office or the Community courts, may provide useful guidelines (judgment of 01/03/2005, T-185/03, Enzo Fusco, EU:T:2005:73, § 52).

There are instances where the applicants invoke, as a defence, their right to use their name. However, such arguments are not valid in opposition proceedings, since it does not influence the issue of whether there will be likelihood of confusion on the part of the public. Furthermore, the registration of trade marks does not hinder the use of personal names, due to the special protection provided by Article 12(a) CTMR and the relevant national trade mark laws according to Article 6(1)(a) of the Trade Mark Directive.

- **First name against the same first name or slight variations thereof**

The rule of thumb is that when two conflicting signs consist exclusively of the same first name, consumers are likely to perceive the similar/identical goods/services marketed under those marks as coming from the same source. It is clear that in the absence of any differentiating element, **likelihood of confusion** is the necessary conclusion.

Earlier sign	Contested sign	Case No
GIORDANO	GIORDANO	T-483/08
<p>G&S: Classes 18, 25 Territory: Portugal Assessment: The two word marks at issue are identical, which increases the likelihood that consumers might perceive the goods marketed under those marks as coming from the same source. Moreover, the applicant has not shown that the Italian first name 'Giordano' which makes up both trade marks is common in Portugal (para. 32) – likelihood of confusion.</p>		
Earlier sign	Contested sign	Case No
ELISE		T-130/09
<p>G&S: Classes 9, 42 Territory: Portugal Assessment: The Court considers that even if it is not certain that the relevant public throughout the European Union will necessarily perceive the signs at issue as being specifically diminutives of the name 'Elizabeth', the relevant public will certainly regard them as highly similar female names derived from the same root. In certain Member States, notably the United Kingdom, Ireland, Germany and Austria, they will certainly be perceived by the relevant public as being diminutives of the full forename Elizabeth (para. 36) – likelihood of confusion.</p>		
Earlier sign	Contested sign	Case No
GISELA	GISELE	R 1515/2010-4
<p>G&S: Class 25 Territory: EU Assessment: The marks compared are both variations of the female first name Giselle of old German and French origin and are overall very similar, so that a likelihood of confusion exists (paras 14, 15 and 20) – likelihood of confusion.</p>		

- **First name against identical first name plus surname**

Whenever two signs share the same first name and one of the two also contains a surname, and when the **first name** is likely to be perceived as a **common** (let alone very common) name in the relevant territory, the rule of thumb is that there will be **no likelihood of confusion**, since consumers will be aware that there are many people with that name.

Earlier sign	Contested sign	Case No
LAURA	LAURA MERCIER	R 0095/2000-2
<p>G&S: Class 3 Territory: Spain Assessment: In the Board's view, the average Spanish consumer who is familiar with the trade mark 'LAURA' for perfumes will not be confused. Conceptually, 'LAURA' will be seen as a common first name in Spain. It is highly unlikely that the average Spanish consumer would consider linking the more specific name 'LAURA MERCIER' with 'LAURA' (para. 16) – no likelihood of confusion.</p>		

An **exception** applies when a given first name is likely to be perceived as **uncommon** in the relevant territory. In such cases, the presence of this uncommon element is likely to focus the consumers' attention and they could be misled into attributing a common origin to the goods/services concerned.



Earlier sign	Contested sign	Case No
AMANDA	AMANDA SMITH	R 1892/2007-2
<p>G&S: Classes 29, 30 Territory: Spain Assessment: The term 'SMITH' in the trade mark application will be perceived by the Spanish consumers as a common Anglo-Saxon surname and will have less weight than the first name 'AMANDA' (which is less common in Spain) (para. 31) – likelihood of confusion.</p>		
Earlier sign	Contested sign	Case No
ROSALIA	ROSALIA DE CASTRO	T-421/10 (appeal dismissed C-649/11P)
<p>G&S: Classes 32, 33, 35 Territory: Spain Assessment: The signs are visually and conceptually similar, and aurally very similar. The products are identical. The services are similar. Neither the name ROSALIA nor the surname DE CASTRO is common in Spain. None of these elements has a higher distinctive character than the other (paras 50-51) – likelihood of confusion.</p>		

- **First name plus surname against identical first name plus different surname**

When two conflicting signs contain the same first name but are followed by clearly different surnames, the rule of thumb is that there is **no likelihood of confusion**. Consumers will realise that they distinguish goods/services of different, unconnected undertakings.

Invented example: 'Michael Schumacher'/'Michael Ballack' (no likelihood of confusion).

However, when the overall impression created by the signs is one of clear similarity, i.e. the differences between the signs are lost in the overall impression created by the signs, then, applying the normal criteria, the outcome will be that there is **likelihood of confusion**.

Earlier sign	Contested sign	Case No
 (Emidio Tucci fig.)		T-8/03 and joined cases R 0700/2000-4 and R 0746/2000-4 Confirmed by C-104/05 P
G&S: Classes 3, 18, 24, 25 Territory: Spain Assessment: Both marks consist of the combination of a first name and a surname and make a similar overall impression – likelihood of confusion.		

- **First name plus surname against different first name plus identical surname**

When the conflicting signs contain the same surname preceded by different first names, the outcome will very much depend on the perception of the surname in the relevant territory. The less common a surname is, the more likely it is that it will attract the consumers' attention (regardless of whether the first names are common or not).

Earlier sign	Contested sign	Case No
ANTONIO FUSCO	ENZO FUSCO	T-185/03
G&S: Classes 18, 25 Territory: Italy Assessment: Since it was contested that 'Fusco' was not one of the most common surnames in Italy, the Court considered that, since the Italian consumer generally attributes greater distinctiveness to the surname than the forename, it will keep in mind the (neither rare nor common) surname 'Fusco' rather than the (common) forenames 'Antonio' or 'Enzo'. Therefore, a consumer faced with goods bearing the trade mark applied for, ENZO FUSCO, might confuse it with the earlier trade mark, ANTONIO FUSCO, so that there is a likelihood of confusion (paras 53 and 67) – likelihood of confusion.		

In contrast, when two marks have the same surname and this is likely to be perceived as common (let alone very common) in the relevant territory, consumers will not normally be misled into attributing a common origin to the goods/services concerned (judgments of 01/03/2005, T-169/03, Sissi Rossi, EU:T:2005:72, § 82-83; and 24/06/2010, C-51/09 P, Barbara Becker, EU:C:2010:368, § 36). Consumers are used to trade marks that contain common surnames and will not blindly assume that every time a common surname occurs in two conflicting signs the goods/services in question all emanate from the same source.

Earlier sign	Contested sign	Case No
VITTORIO ROSSI	CHRISTIAN ROSSI	R 0547/2010-2
G&S: Classes 18, 25 Territory: EU Assessment: Not only are consumers throughout the Community aware of the fact that people share the same surname without being necessarily related, but they will also be able to distinguish the Italian surname 'ROSSI' bearing two different first names in the fashion field (paras 33-35) – no likelihood of confusion.		

- **First name plus surname against different first name plus identical surname conjoined in a single word**

In cases where one of the conflicting signs consists of a name and surname and the other of a single word that will however be broken down into separate components by at least part of the relevant public, due to the recognisable presence of a name and surname combined to form the one word making up that sign, the result will be one of likelihood of confusion whenever the overall impression created by the marks is one of similarity.

Earlier sign	Contested sign	Case No
PETER STORM	Peerstorm	T-30/09
<p>G&S: Class 25 Territory: EU Assessment: Both of the marks at issue are made up of a first name and a surname. It is common ground that the element 'storm' in the two marks at issue can be a surname. The elements 'peer' and 'peter' in the mark applied for and the earlier mark respectively are first names. In particular in the Nordic countries and in Germany, Peer is a first name. The fact that the mark applied for is written as one word cannot cast doubt on the finding that the two marks at issue are made up of a first name and a surname (para. 66) – likelihood of confusion.</p>		

- **Surname against first name plus identical surname**

When two signs contain the same surname but only one of them also contains a given first name, the rule of thumb is that normally there will be **likelihood of confusion**. Consumers might be misled and attribute a common origin to the goods/services concerned. The presence of a first name in one of the conflicting signs will not suffice to safely distinguish the signs in the minds of the consumers. The surname alone will be perceived as the short version of the full name, thus identifying the same origin.



Earlier sign	Contested sign	Case No
MURÚA		T-40/03
<p>G&S: Class 33 Territory: Spain Assessment: It is common ground that the Spanish public will perceive the verbal element making up the trade mark applied for as a proper name (first name plus surnames) and the earlier trade mark as a surname. It is quite likely that the relevant public will regard the addition, in the trade mark applied for, of the first name 'Julián' and the surname 'Entrena' merely as a way of distinguishing a range of wines produced by the undertaker that owns the earlier trade mark or, at least, an undertaking economically linked to the intervener (paras 42 and 78) – likelihood of confusion.</p>		
Earlier signs	Contested sign	Case No
BRADLEY	VERA BRADLEY	R 1918/2010-1
<p>G&S: Class 11 Territory: EU Assessment: The sign for which the CTM applied for seeks protection consists of the term 'Vera Bradley', which will most probably be seen as the name (forename and family name) of a person, fictitious or real. It is composed of the first name 'VERA', which is a common name for women in many</p>		

EU countries such as, e.g. the Czech Republic, Germany, Ireland, the Netherlands, Austria, Slovenia and the United Kingdom, and the surname 'BRADLEY', which is an English family name. The latter surname is not a common family name, neither in English-speaking countries nor in any other countries within the European Union. Even if consumers might be able to distinguish between the signs due to the element 'Vera', which has no counterpart in the earlier trade mark, they will see a specific line of products or an extended form of the mark. Consequently, consumers might believe that the trade marks belong to the same undertakings or economically linked undertakings (paras 36-37 and 52) – likelihood of confusion.

7.3 Colour marks per se

When likelihood of confusion of two colour marks *per se* is assessed, a phonetic or conceptual comparison of the signs cannot be made and the visual similarities will depend on the colour of the signs.

In the overall assessment, the Office takes into account the fact that there is a 'public interest in not unduly restricting the availability of colours for other traders who market goods or services of the same type as those in respect of which registration is sought' (judgments of 24/06/2004, C-49/02 Blau/Gelb, EU:C:2004:384, § 41, and 06/05/2003, C-104/01, Libertel, EU:C:2003:244, § 52-56). The inherent distinctiveness of colour marks *per se* is limited. The scope of protection should be limited to identical or almost identical colour combinations.

Earlier sign	Contested sign	Case No
		<p>R 0755/2009-4</p>
<p>G&S: Class 8 Territory: EU Assessment: In the case at hand, the colour combinations, identified by different colour codes, are not sufficiently close to lead to a likelihood of confusion, taking into account that the inherent distinctiveness is limited (para. 18). The BoA referred to CJEU judgments and public interest in ensuring that colours remain available to competitors (para. 19). The opponent did not prove enhanced distinctive character (para. 25) – no likelihood of confusion.</p>		

***GUIDELINES FOR EXAMINATION IN THE
OFFICE FOR HARMONIZATION IN THE
INTERNAL MARKET (TRADE MARKS AND
DESIGNS) ON COMMUNITY TRADE MARKS***

PART C

OPPOSITION

SECTION 6

PROOF OF USE

Table of Contents

1	General Considerations	5
1.1	Function of proof of use	5
1.2	Legislative framework	5
1.2.1	CTMR and CTMIR	5
1.2.1.1	Article 15 CTMR – obligation to use registered marks	5
1.2.1.2	Article 42 CTMR – consequences of lack of use	6
1.2.1.3	Rule 22 CTMIR – procedural rules, evidence and language	7
1.2.2	Trade Marks Directive and national law implementing the Directive	7
2	Substantive Law	8
2.1	Genuine use: the principles of the Court of Justice	8
2.2	Genuine use: standard of proof applied by the Office	9
2.3	Nature of use: use as a mark in the course of trade	10
2.3.1	The term ‘nature of use’	10
2.3.2	Use as a mark	11
2.3.3	Public use in the course of trade	13
2.3.3.1	Public use v internal use	13
2.3.3.2	Commercial activity v promotional activity	13
2.3.4	Use in relation to goods or services	14
2.3.4.1	Use in relation to goods	14
2.3.4.2	Use in relation to services	15
2.3.4.3	Use in advertising	15
2.3.4.4	Use on the internet	17
2.4	Place of use	19
2.4.1	Use on the ‘domestic’ market	19
2.4.2	CTMs: use in the European Union	19
2.4.3	National marks: use in the relevant Member State	20
2.4.4	Use in import and export trade	20
2.5	Time of use	21
2.6	Extent of use	22
2.6.1	Criteria	22
2.6.2	Examples of insufficient use	24
2.6.3	Examples of sufficient use	25
2.7	Use of the mark in forms different from the one registered	27
2.7.1	Introduction	27
2.7.2	Criteria of the Court	27
2.7.3	Office practice	28
2.7.3.1	Additions	29
2.7.3.2	Omissions	36
2.7.3.3	Other alterations	40
2.8	Use for the goods or services for which the mark is registered	45
2.8.1	Comparison between goods/services used and specification of goods/services	46
2.8.2	Relevance of the classification	47

2.8.3	Use and registration for general indications in 'class headings'	47
2.8.4	Use for subcategories of goods/services and similar goods/services	48
2.8.4.1	Earlier mark registered for broad category of goods/services	48
2.8.4.2	Earlier mark registered for precisely specified goods/services	50
2.8.4.3	Examples.....	50
2.8.5	Use of the mark as regards integral parts and after-sales services of the registered goods	53
2.9	Use by the proprietor or on its behalf	53
2.9.1	Use by the proprietor	53
2.9.2	Use by authorised third parties.....	53
2.9.3	Use of collective marks.....	54
2.10	Legal use.....	54
2.11	Justification of non-use	55
2.11.1	Business risks.....	55
2.11.2	Government or Court intervention	56
2.11.3	Defensive registrations	57
2.11.4	Force majeure.....	57
2.11.5	Consequences of justification of non-use.....	57
3	Procedure.....	58
3.1	Admissibility of the request for proof of use.....	58
3.1.1	Time of request.....	58
3.1.2	Earlier mark registered for not less than five years	58
3.1.2.1	CTMs.....	59
3.1.2.2	National marks	59
3.1.2.3	International registrations designating a Member State	60
3.1.2.4	International registrations designating the European Union	61
3.1.2.5	Summary of calculation of the grace period	61
3.1.3	Request must be explicit, unambiguous and unconditional	62
3.1.4	Applicant's interest to deal with proof of use first	63
3.1.5	Reaction if request is invalid.....	63
3.2	Express invitation by the Office	63
3.3	Reaction from the opponent: providing proof of use	64
3.3.1	Time limit for providing proof of use	64
3.3.2	Means of evidence	65
3.3.2.1	Principles.....	65
3.3.2.2	References.....	67
3.3.2.3	Declarations	67
3.4	Reaction from the applicant	70
3.4.1	Forwarding of evidence	70
3.4.2	No evidence or no relevant evidence submitted	70
3.4.3	No reaction from applicant.....	70
3.4.4	Formal withdrawal of the request	70
3.5	Further reaction from the opponent.....	71
3.6	Languages in proof of use proceedings.....	71
3.7	Decision	72
3.7.1	Competence of the Office.....	72
3.7.2	Need for assessing proof of use.....	72

3.7.3	Overall assessment of the evidence presented	73
3.7.4	Examples	74
3.7.4.1	Genuine use accepted	74
3.7.4.2	Genuine use not accepted.....	75
Annex	77

1 General Considerations

1.1 Function of proof of use

Community legislation on trade marks establishes an ‘obligation’ for the owner of a registered trade mark to use that mark in a genuine manner. The obligation of use is not applicable immediately after registration of the earlier mark. Instead, the owner of a registered mark has a so-called ‘grace period’ of five years during which it is not necessary to demonstrate use of the mark in order to rely upon it — including in opposition proceedings before the Office. After this grace period, the owner may be required to demonstrate use of the earlier mark for the relevant goods and services. Before this period lapses, the mere formal registration gives the mark its full protection.

The reason behind the requirement that earlier marks can be required to demonstrate that they have been put to genuine use is to restrict the number of trade marks registered and protected and, consequently, the number of conflicts between them. This interpretation is supported by the ninth recital in the preamble to Directive 2008/95, which explicitly refers to that objective (judgment of 12/03/2003, T-174/01, Silk Cocoon, EU:T:2003:68, § 38).

When it comes to the requirement to prove use in opposition proceedings before the Office, it is important to bear in mind that the purpose of Article 42(2) and (3) CTMR is not to assess commercial success or to review the economic strategy of an undertaking, nor is it to restrict trade-mark protection to only large-scale commercial use of the marks (judgments of 08/07/2004, T-334/01, Hipoviton, EU:T:2004:223, § 32; 08/07/2004, T-203/02, Vitafruit, EU:T:2004:225, § 38).

The Office does not inquire *ex officio* whether the earlier mark has been used. Such examination takes place only when the CTM applicant makes an explicit request for proof of use. Such a request, if the legal requirements are met, triggers the procedural and substantive consequences laid down in the CTMR and the CTMIR.

1.2 Legislative framework

The legislative framework consists of provisions in the CTMR, in the CTMIR, and in the Trade Marks Directive as implemented in the national law of the Member States.

1.2.1 CTMR and CTMIR

1.2.1.1 Article 15 CTMR – obligation to use registered marks

Article 15 CTMR stipulates the basic substantive requirement for the obligation to use registered marks and Article 15(1) CTMR reads:

If, within a period of five years following registration, the proprietor has not put the Community trade mark to genuine use in the Community in connection with the goods or services in respect of which it is registered, or if such use has been suspended during an uninterrupted period of five years, the Community trade mark shall be subject to the sanctions provided for in this Regulation, unless there are proper reasons for non-use.

In accordance with Article 15(1)(a) and (b) CTMR, the use of the Community trade mark in a form differing in elements that do not alter the distinctive character of the mark in the form in which it was registered and the affixing of the Community trade mark to goods or to the packaging thereof in the Community solely for export purposes, also constitute use within the meaning of Article 15(1) CTMR.

In accordance with Article 15(2) CTMR, use of the Community trade mark with the consent of the proprietor will be deemed to constitute use by the proprietor.

1.2.1.2 Article 42 CTMR – consequences of lack of use

The consequences of a lack of use in opposition proceedings are dealt with in Article 42(2) and (3) CTMR. According to Article 42(2) CTMR:

If the applicant so requests, the proprietor of an earlier Community trade mark who has given notice of opposition shall furnish proof that, during the period of five years preceding the date of publication of the Community trade mark application, the earlier Community trade mark has been put to genuine use in the Community in connection with the goods or services in respect of which it is registered and which he cites as justification for his opposition, or that there are proper reasons for non-use, provided the earlier Community trade mark has at that date been registered for not less than five years. In the absence of proof to this effect, the opposition shall be rejected. If the earlier Community trade mark has been used in relation to part only of the goods or services for which it is registered it shall, for the purposes of the examination of the opposition, be deemed to be registered in respect only of that part of the goods or services.

In accordance with Article 42(3) CTMR:

Paragraph 2 shall apply to earlier national trade marks referred to in Article 8(2)(a), by substituting use in the Member State in which the earlier national trade mark is protected for use in the Community.

There is no express provision in the CTMR that such forms of use as mentioned in Article 15(1) and (2) CTMR may also be regarded as use of earlier national trade marks. However, the concept of the obligation to use the registered mark is harmonised as a consequence of Article 10(2) and (3) of Directive 2008/95/EC of the European Parliament and of the Council of 22 October 2008 to approximate the laws of the Member States relating to trade marks ('Directive'). Hence, it is appropriate to apply the same substantive provision as Article 15(1) and (2) CTMR to the use of earlier national trade marks, with the only difference being that such use must be made in the Member State in which the national mark is registered.

Moreover, it results from the wording of Article 42(2) and (3) CTMR that proof of use can only be requested if the earlier right is a **CTM** or other **trade mark** having effect in the EU or an EU Member State, as defined in Article 8(2)(a) CTMR. Since oppositions brought under **Article 8(4) CTMR** cannot be based on either CTMs or other trade marks referred to in Article 8(2)(a) CTMR, the CTM applicant is not entitled to request proof of use for earlier rights relied upon in oppositions brought under this provision. Nevertheless, Article 8(4) CTMR requires the opponent to prove use in the course of trade of more than mere local significance for the earlier rights in question.

As for **Article 8(3) CTMR**, the Office's practice is that requests for proof of use of the earlier right cannot be made. The reason is that such earlier rights include both trade marks having effect in the EU/EU Member States (CTMs, national trade marks, IRs) **and** national non-EU trade marks, requests for proof of use of the latter not being possible under the CTMR. It would be discriminatory to request proof of use for some countries' trade marks but not for others. Accordingly, and in view of the specific subject matter for protection under Article 8(3) CTMR, while the use or lack of use made of the earlier rights may have a bearing on arguments regarding the justification for applying for the CTMA, the opponent cannot be obliged to provide proof of use under Article 42(3) CTMR for any earlier rights thereby relied upon.

1.2.1.3 Rule 22 CTMIR – procedural rules, evidence and language

In accordance with Rule 22(2) CTMIR, where, pursuant to Article 42(2) or (3) CTMR, the opponent has to submit proof of use or show that there are proper reasons for non-use, the Office will invite the opponent to provide the proof required within a period specified by the Office. If the opponent does not provide such proof before the time limit expires, the Office will reject the opposition.

In accordance with Rule 22(3) CTMIR, the indications and evidence required in order to submit proof of use must consist of indications concerning the place, time, extent and nature of use of the opposing trade mark for the goods and services in respect of which it is registered and on which the opposition is based, and evidence in support of these indications in accordance with paragraph 4.

In accordance with Rule 22(4) CTMIR, the evidence must consist of written documents and in principle be confined to the submission of supporting documents and items such as packages, labels, price lists, catalogues, invoices, photographs, newspaper advertisements, and statements in writing as referred to in Article 78(1)(f) CTMR.

In accordance with Rule 22(5) CTMIR, a request for proof of use may be made with or without submitting, at the same time, observations on the grounds on which the opposition is based. Such observations may be filed together with the observations in reply to the proof of use.

In accordance with Rule 22(6) CTMIR, where the evidence supplied pursuant to paragraphs 1, 2 and 3 is not in the language of the opposition proceedings, the Office may require the opponent to submit a translation of that evidence in that language, within a period specified by the Office.

1.2.2 Trade Marks Directive and national law implementing the Directive

Article 10 of the Directive contains provisions identical to Article 15 CTMR, with 'use in the Community' being replaced by 'use in the Member State'.

2 Substantive Law

2.1 Genuine use: the principles of the Court of Justice

Neither the CTMR nor the CTMIR defines what is to be regarded as 'genuine use'. However, the Court of Justice (the 'Court') has laid down several important principles as regards the interpretation of this term.

'**Minimax**' 2003 (judgment of 11/03/2003, C-40/01, Minimax, EU:C:2003:145): the Court established the following principles:

- genuine use means **actual** use of the mark (paragraph 35);
- genuine use must, therefore, be understood to denote use that is **not merely token**, serving solely to preserve the rights conferred by the mark (paragraph 36);
- genuine use must be consistent with the **essential function** of a trade mark, which is to guarantee the identity of the origin of goods or services to the consumer or end user by enabling the latter, without any possibility of confusion, to distinguish the product or service from others that have another origin (paragraph 36);
- genuine use entails use of the mark **on the market** for the goods or services protected by that mark and not just internal use by the undertaking concerned (paragraph 37);
- genuine use must relate to **goods or services** already marketed or about to be marketed and for which preparations by the undertaking to secure customers are under way, particularly in the form of advertising campaigns (paragraph 37);
- when assessing whether there has been genuine use, regard must be had to all the facts and circumstances relevant to establishing whether the commercial exploitation of the mark is **real**, in particular whether such use is viewed as warranted in the economic sector concerned to **maintain or create a share in the market** for the goods or services protected by the mark (paragraph 38);
- the circumstances of the case may, therefore, include giving consideration, inter alia, to the **nature** of the goods or services at issue, the **characteristics of the market** concerned and the scale and **frequency** of use of the mark (paragraph 39);
- use need **not**, therefore, always be **quantitatively significant** for it to be deemed genuine, as that depends on the characteristics of the goods or services concerned on the corresponding market (paragraph 39).

La Mer 2004 (order of 27/01/2004, C-259/02, Laboratoire de la mer, EU:C:2004:50): the Court further elaborated the 'Minimax' criteria as follows:

- the question whether use is sufficient to preserve or create market share for those goods or services depends on several factors and on a case-by-case assessment. The **characteristics** of those goods and services, the **frequency** or

regularity of the use of the mark, whether the mark is used for the purpose of marketing **all** the identical goods or services of the proprietor or merely some of them, or evidence that the proprietor is able to provide, are among the factors that may be taken into account (paragraph 22);

- use of the mark by a single client which **imports** the goods for which the mark is registered can be sufficient to demonstrate that such use is genuine, if it appears that the import operation has a genuine commercial justification for the proprietor of the mark (paragraph 24);
- a **de minimis rule** cannot be laid down (paragraph 25).

2.2 Genuine use: standard of proof applied by the Office

Article 42 CTMR requires *proof* of genuine use of the earlier mark. Genuine use of a trade mark cannot be proved by means of probabilities or suppositions, but must be demonstrated by **solid and objective evidence** of effective and sufficient use of the trade mark on the market concerned (judgment of 18/01/2011, T-382/08, Vogue, EU:T:2011:9, § 22).

Moreover, the Office cannot determine *ex officio* the genuine use of earlier marks. Even proprietors of purportedly well-known marks must submit evidence to prove genuine use of the earlier mark(s).

The Office does not necessarily require a high threshold of proof of genuine use. The Court has indicated that it is not possible to prescribe, in the abstract, *what quantitative threshold should be chosen* in order to determine whether use was genuine or not, and accordingly there can be no objective *de minimis* rule to establish a priori the level of use needed in order for it to be 'genuine'. So, whilst a minimum extent of use must be shown, what exactly constitutes this minimum extent depends on the circumstances of each case. The general rule is that, when it serves a real commercial purpose, **even minimal use of the trade mark could be sufficient to establish genuine use**, depending on the goods and services, and the **relevant market** (judgments of 23/09/2009, T-409/07, acopat, EU:T:2009:354, § 35 and the quoted case-law; 02/02/2012, T-387/10, Arantax, EU:T:2012:51, § 42).

In other words, it will be sufficient if the evidence of use proves that the trade mark owner has seriously tried to acquire or maintain a commercial position in the relevant market as opposed to having solely used the mark with the intention of preserving the rights conferred by the mark (token use). For instance, in some cases, relatively few sales might be sufficient to conclude that the use is not merely token, in particular with regard to expensive goods (decision of 04/09/2007, R 0035/2007-2, DINKY, § 22). Nonetheless, even if inter alia a very modest amount of use can suffice in certain circumstances, proprietors should adduce comprehensive evidence of use.

In accordance with Rule 22(3) CTMIR, the indications and evidence required in order to provide proof of use must consist of indications concerning the **place, time, extent and nature of use** of the opponent's trade mark for the relevant goods and services.

These requirements for proof of use are **cumulative** (judgment of 05/10/2010, T-92/09, STRATEGI, EU:T:2010:424, § 43). This means that the opponent is obliged not only to indicate but also to prove each of these requirements. However, the sufficiency of the

indication and proof as to the place, time, extent and nature of use has to be considered in view of the *entirety* of the evidence submitted. A separate assessment of the various relevant factors, each considered in isolation, is not suitable (judgment of 17/02/2011, T-324/09, Friboi, EU:T:2011:47, § 31).

Thus, the Office evaluates the evidence submitted in ***an overall assessment***. All the circumstances of the specific case have to be taken into account and all the materials submitted must be assessed *in conjunction with each other*. Therefore, although pieces of evidence may be insufficient by themselves to prove the use of an earlier trade mark, they may contribute to proving use in combination with other documentation and information.

Evidence of use may be of ***an indirect/circumstantial nature***, such as evidence about the share in the relevant market, the import of the relevant goods, the supply of the necessary raw material or packaging to the owner of the mark, or the expiry date of the relevant goods. Such indirect evidence can play a decisive role in the overall assessment of the evidence submitted. Its probative value has to be carefully assessed. For instance, the judgment of 08/07/2010, T-30/09, Peerstorm, EU:T:2010:298, § 42 *et seq.* found that catalogues in themselves could – under certain circumstances – be conclusive evidence of sufficient extent of use.

It is necessary to take into account ***the specific kind of the goods and services involved*** when assessing the probative value of the evidence submitted. For example, it may be common in a particular market sector for the samples of the goods and services themselves not to bear indications of the place, time, extent and nature of use. In these cases it is obviously inappropriate to disregard such evidence of use if indications in this respect can be found in the other evidence submitted.

Each of the documents submitted has to be carefully evaluated as to whether it really reflects use in the five years preceding the publication of the CTM application (see in this regard paragraph 2.5 below) or use in the relevant territory (see paragraph 2.4 below). In particular, the dates and place of use shown on orders, invoices and catalogues are carefully examined.

Material submitted ***without any indication of date of use*** may, in the context of an overall assessment, still be relevant and taken into consideration *in conjunction with other pieces* of evidence that are dated (judgment of 17/02/2011, T-324/09, Friboi, EU:T:2011:47, § 33). This is the case in particular if it is common in a particular market sector for the samples of the goods and services themselves not to bear indications of time (decision of 05/09/2001, R 0608/2000-4, Palazzo, § 16, noting that ice-cream menus are rarely dated).

For implementation of the abovementioned general principles in practice, see the examples in paragraph 3.7.4 below.

2.3 Nature of use: use as a mark in the course of trade

2.3.1 The term ‘nature of use’

The required ‘nature of use’ of the sign refers to:

- its use as a trade mark in the course of trade;

the use of the mark as registered, or of a variation thereof according to Article 15(1)(a) CTMR (paragraph 2.7 below); and

the use for the goods and services for which it is registered (paragraph 2.8 below).

2.3.2 Use as a mark

Articles 15 and 42(2) CTMR require proof of genuine use in connection with the goods or services for which the trade mark is registered and which the opponent cites as justification for its opposition. Hence, the opponent has to show that the mark has been used as a trade mark on the market.

As a trade mark has, *inter alia*, the function of operating as a link between the goods and services and the person responsible for their marketing, the proof of use must establish a **clear link between the use of the mark and the relevant goods and services**. As clearly indicated in Rule 22(4) CTMIR, it is not necessary for the mark to be affixed to the goods themselves (judgment of 12/12/2014, T-105/13 TrinkFix, EU:T:2014:1070, § 28-38) A representation of the mark on packaging, catalogues, advertising material or invoices relating to the goods and services in question constitutes direct evidence that the mark has been put to genuine use (see also paragraph 2.3.3.2 below).

Genuine use requires that use is made as a *trade mark*:

not for purely illustrative purposes or on purely promotional goods or services.

in accordance with its essential function, which is to guarantee the identity of the origin of the goods or services for which it is registered (judgment of 11/03/2003, C-40/01, *Minimax*, EU:C:2003:145, § 43).

Therefore, by way of example, the following are not suitable for supporting genuine use of the trade mark.

- Use as a *certification mark*. Certification marks can be obtained in some jurisdictions for compliance with defined standards. The holder of a certification mark is not the authorised user, producer or provider of the certified goods or services, but rather the certifier, who exercises legitimate control over the use of the certification mark. Certification marks may be used together with the individual trade mark of the producer of the certified goods or of the provider of the certified services. The essential function of a certification mark is different from the essential function of an individual trade mark: while the latter primarily serves to identify the origin of goods and services, the former serves to certify that the goods or services meet certain established standards and possess particular characteristics. Therefore, use as certification mark does not serve as use as individual trade mark, which is the use required by Article 42(2) and (3) CTMR (decision of 16/08/2011, R 0087/2010-2, *DVC-DVB*, § 32).
- Use as a *Protected Geographical Indication (PGI)/Protected Denomination of Origin (PDO)*. The essential function of PGIs/PDOs is to designate the origin of goods as being from a particular region or locality. This is in contrast with the main function of an individual trade mark, namely to serve as an indicator of

commercial origin. When a PGI/PDO has been registered as an individual mark (and not, for example, as a collective mark), the opponent has to submit proof about the use as an individual mark. Evidence of use as PGI/PDO (e.g. general statements of Regulatory Councils) cannot serve for proving use as an individual mark. If the PGI/PDO is registered as a collective mark, evidence of use must be provided to show that the PGI/PDO is used according to the essential function of collective marks, which is to distinguish the goods or services of the members of the association that is the proprietor of the mark from those of other undertakings (decision of 23/11/2011, R 1497/2010-2, YECLA, § 34 and 45).

Depending on the circumstances, the following situations may be suitable for supporting genuine use of the registered trade mark. That is because the use of the sign can serve more than one purpose at the same time. Consequently, the following uses can also be use of the sign as a trade mark. However, for which purposes a sign is used needs to be assessed individually.

The **use of a sign as a business, company or trade name** can be regarded as trade mark use provided that the relevant goods or services themselves are identified and offered on the market under this sign (judgment of 13/04/2011, T-209/09, Alder Capital, EU:T:2011:169, § 55-56). In general, this is not the case when the business name is merely used as a shop sign (except when proving use for retail services), or appears on the back of a catalogue or as an incidental indication on a label (judgment of 18/01/2011, T-382/08, Vogue, EU:T:2011:9, § 47).

In principle, the use of the sign as a **company name or trade name**, is not, of itself, intended to distinguish goods or services. The purpose of a *company name* is to identify a company, whereas the purpose of a *trade name* or a *shop name* is to designate a business which is being run. Accordingly, where the use of a company name, trade name or shop name is limited to identifying a company or designating a business which is being run, such use cannot be considered as being 'in relation to goods or services' (judgments of 11/09/2007, C-17/06, Céline, EU:C:2007:497, § 21; 13/05/2009, T-183/08, Jello Schuhpark II, EU:T:2009:156, § 31-32).

The use of a business, company or trade name can be regarded as use 'in relation to goods' where:

- (a) a party *affixes the sign* constituting its company name, trade name or shop name to the goods or;
- (b) even though the sign is not affixed, that party uses that sign in such a way that a *link is established* between the company, trade or shop name and the goods or services (judgment of 11/09/2007, C-17/06, Céline, EU:C:2007:497, § 21-23).

Provided that either of these two conditions is met, the fact that a word element is used as the company's trade name does not preclude its use as a mark to designate goods or services (judgment of 30/11/2009, T-353/07, Coloris, EU:T:2009:475, § 38).

For example, the presentation of the business name at the top of *order forms* or *invoices*, depending on how the sign appears on them may be suitable to support genuine use of the registered trade mark (judgment of 06/11/2014, T-463/12, MB, EU:T:2014:935, § 44-45).

However, mere use of a business name at the top of invoices without a clear reference to specific products/services is not sufficient.

Use of a sign as a *domain name or as part of a domain name* primarily identifies the website as such. However, depending on the circumstances, such use may also be use of a registered mark (which presupposes that it connects to a site on which the goods and services appear).

The mere fact that the opponent has registered a domain name containing the earlier trade mark is not sufficient in itself to prove genuine use of this trade mark. It is necessary for the party to prove that the relevant goods or services are offered under the trade mark contained in the domain name.

2.3.3 Public use in the course of trade

2.3.3.1 Public use v internal use

The use must be public, i.e. it must be external and apparent to actual or potential customers of the goods or services. Use in the private sphere or purely internal use within a company or a group of companies does not amount to genuine use (judgments of 09/12/2008, C-442/07, Radetzky, EU:C:2008:696, § 22; 11/03/2003, C-40/01, Minimax, EU:C:2003:145, § 37).

The mark must be used **publicly and outwardly** in the context of commercial activity with a view to economic advantage for the purpose of ensuring an outlet for the goods and services that it represents (judgments of 12/03/2003, T-174/01, Silk Cocoon, EU:T:2003:68, § 39; 30/04/2008, T-131/06, Sonia Sonia Rykiel, EU:T:2008:135, § 38). Outward use does not necessarily imply use aimed at end consumers. For instance, the relevant evidence can validly stem from an **intermediary**, whose activity consists of identifying professional purchasers, such as distribution companies, to whom the intermediary sells products it has had manufactured by original producers (judgment of 21/11/2013, T-524/12, RECARO, EU:T:2013:604, § 25-26).

Relevant evidence can also validly come from a **distribution company** forming part of a group. Distribution is a method of business organisation that is common in the course of trade and implies use of the mark that cannot be regarded as purely internal use by a group of companies, since the mark is also used outwardly and publicly (judgment of 17/02/2011, T-324/09, Friboi, EU:T:2011:47, § 32).

Use of the mark must **relate to goods or services** already marketed or about to be marketed and for which preparations by the undertaking to secure customers are under way. Mere preparation to use the mark – such as the printing of labels, producing of containers, etc. – is internal use and, therefore, not use in the course of trade for the present purposes (judgment of 11/03/2003, C-40/01, Minimax, EU:C:2003:145, § 37).

2.3.3.2 Commercial activity v promotional activity

Where the mark is protected for goods or services of **not-for-profit enterprises**, and the mark has been used, the fact that there is no profit motive behind the use is irrelevant: ‘The fact that a charitable association does not seek to make profit does not mean that its objective cannot be to create and, later, to preserve an outlet for its goods or services’ (judgment of 09/12/2008, C-442/07, Radetzky, EU:C:2008:696, § 17).

Goods and services offered **free of charge** may constitute genuine use when they are offered commercially, i.e. with the intention of creating or maintaining an outlet for those goods or services in the EU, as opposed to the goods or services of other undertakings, and therefore of competing with them (judgment of 09/09/2011, T-289/09, Omnicare Clinical Research, EU:T:2011:452, § 67-68).

Mere use of the mark on **promotional material for other goods** cannot normally be considered as sufficient (indirect) evidence of use within the meaning of trade mark law for the type of promotional items on which the mark is or has been used. For example, giving away articles of clothing such as T-shirts and baseball caps at promotional events with the purpose of marketing a certain other product, such as a drink, cannot be considered as genuine use of the mark at issue for clothing.

The Office practice concerning ‘genuine use’ with regard to promotional articles has been confirmed by the Court:

Earlier sign	Case No
WELLNESS	C-495/07 (preliminary ruling)
<p>The opponent owned the mark ‘WELLNESS’ in Classes 25 and 32. In the context of selling its ‘WELLNESS’ clothing, it also used the mark to designate an alcohol-free drink, which was handed out in small bottles as a gift along with the clothing sold. No drinks were sold separately under the ‘WELLNESS’ mark.</p> <p>The Court held that, where promotional items are handed out as a reward for the purchase of other goods and to encourage the sale of the latter, the mark loses its commercial raison d’être for the promotional goods and cannot be considered to have been genuinely used on the market for goods in that class (paragraph 22).</p>	

2.3.4 Use in relation to goods or services

2.3.4.1 Use in relation to goods

Trade marks have traditionally been used on goods (printed on the goods, on labels, etc.) or their packaging. However, showing use on goods or their packaging is not the only way of proving use in relation to goods. It is sufficient, if there is a proper connection between the mark and the goods, for the mark to be used ‘in relation to’ the goods or services, such as on brochures, flyers, stickers, signs inside places of sale, etc.

For example, when the opponent sells its goods only through catalogues (mail-order sales) or the internet, the mark may not always appear on the packaging or even on the goods themselves. In such cases, use on the (internet) pages where the goods are presented – provided it is otherwise genuine in terms of time, place, extent and nature (see paragraph 2.3.4.4) – will generally be considered sufficient. The owner of the mark will not have to provide proof that the mark actually appeared on the goods themselves.

Earlier sign	Case No
PETER STORM	T-30/09
<p>The evidence produced to show genuine use of the mark at issue may include catalogues. (...) it must be</p>	

pointed out that, in addition to items of clothing designated by different marks, more than 80 different items are offered for sale in that catalogue under the mark PETER STORM. They comprise men's and women's jackets, jumpers, trousers, T-shirts, footwear, socks, hats and gloves, the respective characteristics of which are briefly described. The earlier mark appears, in stylised characters, next to each item. In that catalogue, the prices of the items in GBP and the reference number for each item are stated (paragraphs 38-39).

However, a situation is different, when a trade mark is used, for example, in a catalogue, on advertisements, bags or invoices to designate the retailer of the goods and not the goods themselves:

Earlier sign	Case No
Schuhpark	T-183/08
The GC found that the use of the sign <i>Schuhpark</i> for footwear on advertisements, bags and invoices was not meant to identify the origin of the shoes (which bore their own mark or no mark at all) but rather the company name or trade name of the shoe retailer. This was considered insufficient to establish a link between the sign <i>Schuhpark</i> and the shoes. In other words, <i>Schuhpark</i> may well be a mark for the retail of shoes, but it was not used as a trade mark for goods (paragraphs 31-32).	

2.3.4.2 Use in relation to services

Marks cannot be directly used 'on' services. Therefore, as regards marks registered for services, their use will generally be on business papers, in advertising, or in some other way directly or indirectly related to the services. Where the use on such items demonstrates genuine use, such use will be sufficient.

Earlier sign	Case No
M&P	T-463/12
Earlier trade mark registered in Class 42 for, inter alia, services of a patent attorney. The use of the earlier mark on invoices, business cards, business correspondence was considered sufficient to show genuine use in connection to the services of a patent attorney.	
STRATEGIES	T-92/09
Where an earlier mark was registered for 'business management' services and used as the title of business magazines, the GC did not exclude that such use be considered genuine for the services in question. This could be the case if it is shown that the magazine provides support for the supply of the 'business management' services, i.e. if these services are provided through the medium of a magazine. The fact that there is no 'direct bilateral link' between the publisher and the recipient of the services does not impair such a finding of genuine use. This is because the magazine is not distributed free of charge, which could give credibility to the claim that the payment of the price of the magazine constitutes remuneration for the service provided (paragraphs 31-35).	

2.3.4.3 Use in advertising

Trade marks fulfil their function of indicating the commercial origin of goods or services and symbols of the goodwill of their owner not only when they are actually used on or for goods or services, but also when they are used in advertising. In fact, the advertising or market communication function of trade marks is one of their most important functions.

Therefore, use in advertising will generally be considered as amounting to genuine use:

- if the volume of advertising is sufficient to constitute genuine public use of the mark; and
- if a relation can be established between the mark and the goods or services for which the mark is registered.

The Court confirmed this approach in the ‘Minimax’ case, where it held that use of the mark must relate to goods or services already marketed or about to be marketed and for which preparations by the undertaking to secure customers are under way, *particularly in the form of advertising campaigns* (judgment of 11/03/2003, C-40/01, Minimax, EU:C:2003:145, § 37).

However, the outcome in a particular case will depend very much on the individual circumstances, as demonstrated by the following examples:

Earlier sign	Case No
BLUME	R 0681/2001-1
<p>Services: services of a publishing company in Class 41.</p> <p>The Board confirmed that the evidence (consisting of catalogues, press notes and advertisements) read in conjunction was enough to prove genuine use of the trade mark.</p> <p>‘Although the order record and the receipt of the bank account do not provide any information on how and to what extent the mark was used in Spain, the remaining documents, namely the catalogues, press notes and advertisements, when read in conjunction, demonstrate that during the relevant period, the opponent has published in Spain books and magazines under the trade mark BLUME. Even if the opponent does not provide any invoices, orders or sales figures, there is some reason to assume that it advertised its books and magazines, promoted and sold them under the trade mark BLUME. Although the advertising documents and the press notes were identified and dated by the opponent, the trade mark BLUME is always mentioned in the press notes and on the cover page of the quoted books. In addition, the text is in the Spanish language and the price mentioned in pesetas. When read together with the catalogues, these press notes demonstrate that they refer to some of the books expressly quoted in the catalogues ...’ (paragraph 23).</p>	

Earlier sign	Case No
BIODANZA	R 1149/2009-2 (confirmed by T-298/10)
<p>G&S: Classes 16 and 41.</p> <p>The Board rejected the Opposition Division’s finding that the evidence (only advertisements) proved genuine use.</p> <p>It follows clearly from the finding of the contested decision that the evidence of use submitted by the opponent consists solely of advertisements that can prove only that the opponent advertised a yearly ‘BIODANZA’ festival during the whole of the relevant period and workshops on both a regular and irregular basis from 2002.</p> <p>However, contrary to the finding of the contested decision, such advertisements cannot provide proof of their distribution to a potential German clientele. Nor can they prove the extent of any distribution or the number of sales or contracts made for the services protected by the mark. The mere existence of advertisements could, at most, make it probable or credible that the services advertised under the earlier mark were sold or, at least, offered for sale within the relevant territory, but it cannot prove this, as was unduly supposed by the contested decision.</p>	

Where advertising is carried out in parallel to the marketing of goods and services and there is proof of both activities, advertising will support the genuineness of the use.

Advertising in advance of the actual marketing of goods and services – if it is with a view to establishing a market for the goods or services – will generally be considered to constitute genuine use.

Whether mere advertising, without any current or future plans to actually market goods or services, constitutes genuine use appears doubtful. As in most other situations, the outcome will depend on the circumstances of each case. For example, where the goods or services are available abroad, such as holiday accommodation or particular products, advertising alone may be sufficient to amount to genuine use.

2.3.4.4 Use on the internet

The standard applied when assessing evidence in the form of printouts from the internet is no stricter than when evaluating other forms of evidence. Consequently, the presence of the trade mark on websites can show inter alia the nature of its use or the fact that products or services bearing the mark have been offered to the public. However, the mere presence of a trade mark on a website is, of itself, not sufficient to prove genuine use unless the website also shows the place, time and extent of use or unless this information is otherwise provided.

Earlier sign	Case No
SHARP	R 1809/2010-4
The opponent submitted 'extracts from the opponent's websites for different countries'. The Board considered that 'simple print-outs from a company's own Internet page is not able to prove use of a mark for certain goods without complementary information as to the actual use of the Internet site by potential and relevant consumers or complementary advertising and sales figures regarding the different goods, photos of the goods with the corresponding mark etc.' (paragraph 33).	

Earlier sign	Case No
WALZERTRAUM	T-355/09 (confirmed by C-141/13 P)
The opponent, a confectionary, who owns the German trade mark 'WALZERTRAUM' for goods in Class 30, in order to prove the extent of use of its mark, submitted evidence regarding an advertising brochure published on the internet, which gives general information about its working methods, the ingredients used for its products and the product range, including its 'WALZERTRAUM' chocolate. The goods could, however, not be ordered online on the web page. For this reason the GC held that a connection between the website and the number of items sold could not be established (paragraph 47).	

In particular, the value in terms of evidence of internet extracts can be strengthened by submitting evidence that the specific website has been visited and, in particular, that orders for the relevant goods and services have been made through the website by a certain number of customers in the relevant period. For instance, useful evidence in this regard could be records that are generally kept when operating a business web page, for example records relating to the hits attained at various points in time or, in some cases, the countries from which the web page has been accessed.

As to the *relevant period*, information on the internet or in online databases is considered to be of the date on which the information was posted. Internet websites often contain highly relevant information. Certain information may even be available

only on the internet from such websites. This includes, for example, online catalogues that are not available in printed format.

The nature of the internet can make it difficult to establish the actual date on which information was in fact made available to the public. For instance, not all web pages mention when they were published. In addition, websites are easily updated, yet most do not provide any archive of previously displayed material, nor do they display records which enable members of the public to establish precisely what was published when.

In this context, the date of use on the internet will be considered reliable in particular where:

- the website time-stamps each entry and thus provides information relating to the history of modifications applied to a file or web page (for example, as available for Wikipedia or as automatically appended to content, e.g. forum messages and blogs); or
- indexing dates are given to the web page by search engines (e.g. from the Google™ cache); or
- a screenshot of a web page bears a given date.

The evidence submitted must show that the online transactions were *connected with the goods or services* designated by the mark.

Earlier sign	Case No
ANTAX	T-387/10
The opponent has submitted, inter alia, internet extracts from the home pages of several tax consultancies using the opposing mark. The GC considered that the indications on the internet pages allowed the reader to establish a link between the trade mark and the services provided (paragraphs 39-40).	

Whereas the *nature of the mark* and, to a certain extent, the *time* (as seen above) and *place* are less complex elements to prove, the *extent of the use* presents more difficulties if only evidence of internet use is provided. It should be taken into account that transactions on the internet tend to eliminate most of the 'traditional' evidence of sales such as invoices, turnover, taxation documents, etc. New 'electronic' evidence tends to substitute them, or has already substituted them, as certified means of payment, orders and confirmations thereof, registrations of safe transactions, etc.

Earlier sign	Case No
Skunk funk (fig.)	R 1464/2010-2
'[E]xcerpts from third parties' websites, despite having been printed out on 10 June 2008, contain consumers' comments about 'SKUNKFUNK' clothes and shops dated within the relevant period. In particular, as regards the relevant territory, the documents show various comments made by consumers in Spain and dated December 2004 and February-March-April-May-July 2007. Moreover, as the Opposition Division pointed out, a blog comment (dated 4 March 2007) on the internet page www.cybereuskadi.com mentions that the opponent ('designer of Skunkfunk') 'exports surf clothes worldwide and has a turnover of nearly 7 million euros per year' (paragraph 21).	

2.4 Place of use

2.4.1 Use on the 'domestic' market

Trade marks must be used in the territory where they are protected (European Union for CTMs, the territory of the Member State for national marks or Benelux for Benelux marks and the territories of the relevant countries for international registrations).

As the Court held in 'Leno Merken' 'the territorial scope of the use is only one of several factors to be taken into account in the determination of whether that use is genuine or not' (judgment of 19/12/2012, C-149/11, Leno, EU:C:2012:816, § 30). The Court further indicated that use of the mark in non-EU territories cannot be taken into account (paragraph 38).

In view of the globalisation of trade, an indication of the registered seat of the owner of the mark may not be regarded as sufficient indication that the use has taken place in that particular country. Even though Article 15(1)(b) CTMR stipulates that the affixing of the trade mark to goods or to the packaging thereof in the European Union solely for export purposes is considered as use of the mark, mere indication of the opponent's seat as such does not constitute evidence of such acts. On the other hand, the fact that clients who have their seats outside the relevant territory are listed in the documents for proving use of the earlier mark is in itself not sufficient to rule out that services (e.g. promotion services) may actually have been rendered in the relevant territory for the benefit of these companies located in other territories (decision of 09/06/2010, R 0952/2009-1, Global Tabacos, § 16).

2.4.2 CTMs: use in the European Union

If the earlier mark is a Community mark, it must be used 'in the Community' (Articles 15(1) and 42(2) CTMR). Following 'Leno Merken', Article 15(1) CTMR must be interpreted as meaning that the territorial borders of the Member States should be disregarded when assessing whether a CTM has been put to 'genuine use' in the Community (paragraph 44).

In territorial terms and in view of the unitary character of the CTM, the appropriate approach is not that of political boundaries but of market(s). Moreover, one of the aims pursued by the CTM system is to be open to businesses of all kinds and sizes. Therefore, the size of an undertaking is not a relevant factor to establish genuine use.

As the Court indicated in 'Leno Merken', it is impossible to determine a priori and in the abstract what territorial scope should be applied in order to determine whether the use of the mark is genuine or not (paragraph 55). All the relevant facts and circumstances must be taken into account, including the characteristics of the market concerned, the nature of the goods or services protected by the trade mark and the territorial extent and scale of the use as well as its frequency and regularity (paragraph 58). For example, a Board of Appeal decision (decision of 07/03/2013, R 0234/2012-2, NOW, confirmed by the judgment of 30/01/2015, T-278/13, now, EU:T:2015:57) considered the use of a CTM for wireless broadband services in Class 42 in the geographical area comprising London and the Thames Valley sufficient to constitute genuine use in the United Kingdom and also in the European Union, taking into account: the 'territorial extent' [being London 'the largest city in the United Kingdom and the largest urban zone in the European Union' with 'a metropolitan area of an estimated total population

of between 12 million and 14 million people’, ‘the world’s leading financial centre along with New York’, ‘a leading centre of arts, science, tourism and media and information technology’, with a profile on the European commercial scene ‘disproportionately high in respect to the services in question’ (R 0234/2012-2, § 47) and being the Thames Valley ‘200 miles long and 30 miles wide’ including ‘populous towns and cities of significant economic activity’ (R 0234/2012-2, § 45-46)], the ‘scale, frequency, regularity of use’ and the ‘characteristics’ of the market concerned (R 0234/2012-2, § 52).

The Office must determine on a case-by-case basis whether the various indications and evidence can be combined for the purpose of assessing the genuine character of use, the geographical dimension of which is only one of the aspects to be considered.

In any event, it must be underlined that the European requirements or standards for genuine use are applicable (i.e. the conditions of Article 15 CTMR) and not national standards or practices applied to CTMs.

2.4.3 National marks: use in the relevant Member State

If the earlier mark is a national mark with effect in one of the Member States of the European Union, the mark must have been genuinely used in the country where it is protected (Article 42(3) CTMR). Use in a part of the Member State, provided it is genuine, may be considered sufficient:

Case No	Earlier trade mark	Comment
C-416/04 P	VITAFRUT	Use considered sufficient, even though the earlier Spanish mark was not present in a substantial part of the territory of Spain, given that the evidence referred to the sale of everyday consumer goods (concentrated fruit juices) to only a single customer in Spain (paragraphs 60, 66 and 76).

If the earlier mark is a international mark or a Benelux mark, the mark must have been genuinely used in the territory of the relevant countries of the international registration or in Benelux.

2.4.4 Use in import and export trade

According to Article 15(1)(b) CTMR, the affixing of the Community trade mark to goods or to the packaging thereof in the Community solely for **export** purposes also constitutes use within the meaning of Articles 15(1) CTMR. The mark has to be used (i.e. affixed to goods or their packaging) in the relevant market – that is, the geographical area where it is registered.

Case No	Earlier trade mark	Comment
T-34/12	Herba Shine	The Court ruled that the Board of Appeal should have reasoned why it disregarded evidence of sales outside the relevant territory (invoices addressed to clients outside the EU). In fact, such sales outside the EU cannot be simply discarded for that reason only (paragraphs 48-49 and 54).
R 0602/2009-2	RED BARON	The Board indicated that sales in Austria and Great Britain from the Netherlands also constituted genuine use in the Netherlands within the meaning of Article 15(1)(b) CTMR (paragraph 42).

Evidence that only relates to the **import** of the goods in the relevant area may, depending on the circumstances of the case, suffice as proof of use in this area (see by analogy judgment of 09/07/2010, T-430/08, Grain Millers, EU:T:2010:304, § 33, 40 *et seq.* regarding the proof of use in the course of trade of a sign on the basis of imports from Romania to Germany).

The Court has held that **transit**, which consists in transporting goods lawfully manufactured in a Member State to a non-member country by passing through one or more Member States, does not involve any marketing of the goods in question and is therefore not liable to infringe the specific subject matter of the trade mark (regarding the transit through France of goods originating in Spain and destined for Poland, see judgments of 23/10/2003, C-115/02, Rioglass and Transremar, EU:C:2003:587, § 27; 09/11/2006, C-281/05, Diesel, EU:C:2006:709, § 19). Therefore, mere transit through a Member State cannot constitute genuine use of the earlier mark in that territory.

2.5 Time of use

If the earlier mark is subject to the use requirement at all (registered for not less than five years), the actual period for which use must be shown can simply be computed backwards from the publication date.

For example, if the contested CTM application was published on 15/06/2012, the opponent would have to prove genuine use of its mark within the period beginning on 15/06/2007 and ending on 14/06/2012.

For oppositions filed against international registrations designating the EU, the opponent's mark is under the use obligation if, at the beginning of the opposition period (which is six months after the date of the first re-publication of the international registration), it has been registered for not less than five years. For example, if the contested international registration was published on 15/06/2009, and the earlier mark was registered on 01/04/1996 the opponent would have to prove genuine use of its mark within the period beginning on 15/12/2004 and ending on 14/12/2009.

In the event that the European Union has not been designated in the international application but in a subsequent designation, the 18 months start from the date that the subsequent designation was notified to the Office. See decision of 20/12/2010, R 0215/2010-4, Purgator.

From the day of the subsequent designation of the European Community, an international registration has the same effect as the application for a Community trade mark, against which opposition can be raised. Publication of the date of the subsequent designation will take the place of publication of the application of the Community trade mark (Article 152 CTMR). In the present case, publication of the date of the

subsequent designation of the European Community took place on 8 October 2007. At this point, the earlier trade marks with a registration date of 14/06/2005 had not yet been registered for five years and were not subject to a requirement of use.

Evidence referring to use made outside the relevant time frame is in general immaterial, unless it constitutes conclusive indirect proof that the mark must have been put to genuine use also during the relevant time. The Court held in this context that circumstances subsequent to the relevant point of time may make it possible to confirm or better assess the extent to which the trade mark was used during the relevant period and the real intentions of the proprietor during that time (order of 27/01/2004, C-259/02, *Laboratoire de la mer*, EU:C:2004:50, § 31).

Where a mark has not been genuinely used for more than five years before the publication date, the fact that there may be remaining goodwill or knowledge of the mark in the mind of the trade or customers does not 'save' the mark.

The use need not have been made throughout the period of five years, but rather within the five years. The provisions on the use requirement do not require continuous use (judgment of 16/12/2008, T-86/07, *Deitech*, EU:T:2008:577, § 52).

2.6 Extent of use

2.6.1 Criteria

In this regard, it has to be evaluated whether, in view of the market situation in the particular industry or trade concerned, it can be deduced from the material submitted that **the owner has seriously tried to acquire a commercial position in the relevant market**. The trade mark has to be used for goods or services already marketed or about to be marketed and for which preparations by the undertaking to secure customers are under way, particularly in the form of advertising campaigns (judgment of 11/03/2003, C-40/01, *Minimax*, EU:C:2003:145, § 37). This does not mean that the opponent has to reveal the total volume of sales or turnover figures.

Concerning the extent of the use made of the earlier mark, account must be taken, in particular, of the **commercial volume** of all the acts of use on the one hand and the **duration** of the period in which those acts of use occurred as well as the **frequency** of those acts on the other (judgment of 08/07/2004, T-334/01, *Hipoviton*, EU:T:2004:223, § 35).

The assessment entails a *degree of interdependence between the factors* taken into account. Thus, the fact that commercial volume achieved under the mark was not high may be offset by the fact that use of the mark was extensive or very regular, and vice versa (judgment of 08/07/2004, T-203/02, *Vitafruit*, EU:T:2004:225, § 42).

Under certain circumstances, even *circumstantial evidence* such as catalogues featuring the trade mark, despite not providing direct information on the quantity of goods actually sold, can be sufficient by themselves to prove the extent of use in an overall assessment (judgment of 08/07/2010, T-30/09, *Peerstorm*, EU:T:2010:298, § 42 *et seq.*).

Use does not have to be made during a minimum period of time to qualify as 'genuine'. In particular, *use does not have to be continuous* during the relevant period of five years. It is sufficient if the use had been made at the very beginning or end of the

period, provided that this use was genuine (judgment of 16/12/2008, T-86/07, Deitech, EU:T:2008:577).

The exact *decisive threshold* proving genuine use cannot be defined out of context. The turnover and volume of sales of the product must always be assessed in relation to all the other relevant factors, such as the volume of business, production or marketing capacity or the degree of diversification of the undertaking using the trade mark and the characteristics of the products or services on the relevant market. Use need not always be quantitatively significant for it to be deemed genuine, as that depends on the characteristics of the goods or service concerned on the corresponding market (judgments of 11/03/2003, C-40/01, Minimax, EU:C:2003:145, § 39; 08/07/2004, T-203/02, Vitafruit, EU:T:2004:225, § 42).

Low turnover and sales, in absolute terms, of a medium- or low-priced product might support the conclusion that use of the trade mark in question is not genuine. However, with regard to expensive goods or an exclusive market, low turnover figures can be sufficient (decision of 04/09/2007, R 0035/2007-2, Dinky, § 22). It is, therefore, always necessary to take the characteristics of the market in question into account (judgment of 08/07/2004, T-334/01, Hipoviton, EU:T:2004:223, § 51).

A *de minimis* rule cannot be laid down. Use of the mark by a single client, which imports the products for which the mark is registered, can be sufficient to demonstrate that such use is genuine if it appears that the import operation has a genuine commercial justification for the proprietor of the mark (order of 27/01/2004, C-259/02, Laboratoire de la mer, EU:C:2004:50, § 24 *et seq.*).

The genuine use is not excluded only because the use has been made with the same customer, as long as the trade mark is used publicly and outwardly and not solely within the undertaking which owns the earlier trade mark or within a distribution network owned or controlled by that undertaking (judgments of 08/07/2004, T-203/02, Vitafruit, EU:T:2004:225, § 50; 8/10/2014, T-300/12, Fairglobe, EU:T:2014:864, § 36).

The smaller the commercial volume of the exploitation of the mark, the more necessary it is for the opposing party to produce additional evidence to dispel possible doubts as to its genuineness (judgment of 08/07/2004, T-334/01, Hipoviton, EU:T:2004:223, § 37).

Concerning the ratio between the turnover generated by the sales of products under the earlier mark and the applicant's annual turnover, it should be noted that the degree of diversification of the activities of undertakings operating in one and the same market varies. Moreover, the obligation to produce evidence of genuine use of an earlier trade mark is not designed to monitor the commercial strategy of an undertaking. It may be economically and objectively justified for an undertaking to market a product or a range of products even if their share in the annual turnover of the undertaking in question is minimal (judgment of 08/07/2004, T-334/01, Hipoviton, EU:T:2004:223, § 49).

Special circumstances, for example, lower sales figures during the initial marketing phase of a product, could be of relevance when assessing the genuineness of the use (judgment of 08/07/2004, T-334/01, Hipoviton, EU:T:2004:223, § 53).

2.6.2 Examples of insufficient use

Case No	Comment
Judgment of 16/07/2014, T-196/13, NAMMU, EU:T:2014:1065	The applicant provided an affidavit signed by the Head of the Import Department and Quality Manager; photos, including one of a Nanu-Nana shop front, and others, undated, of various goods such as folded paper boxes, albums, calendars, stickers, blocks, artists' materials, cards and other paper products, napkins, recipe books, furniture and home decor articles. The goods depicted all bear labels and stickers with the earlier mark on their packaging. No evidence was submitted to prove the turnover figures given in the affidavits, and the photos were undated (paragraph 33).
'WALZERTRAUM', paragraph 32 ff. (confirmed by C-141/13 P)	The opponent, a German bakery located in a city of 18 000 inhabitants, proved constant monthly sales of approximately 3.6 kg of exclusive, handmade chocolates over a period of 22 months. Despite being advertised on a web page accessible throughout the world, the chocolates could only be ordered and bought in the opponent's bakery. In view of the territorial and quantitative limits, the GC considered that use had not been sufficiently proven.
Judgment of 30/04/2008, T-131/06, Sonia Sonia Rykiel, EU:T:2008:135	54 units of women's slips and 31 units of petticoats were sold over a period of 13 months, for a total sum of EUR 432. The GC considered these modest quantities with regard to the relevant market (everyday consumption goods, sold at a very reasonable price) to be insufficient.
Decision of 27/02/2009, R 0249/2008-4, AMAZING ELASTIC PLASTIC II	500 plastic balloon kits given away as 'samples' free of charge cannot constitute genuine use.
Decision of 20/04/2001, R 0378/2000-1, Renacimiento	The Board of Appeal confirmed the decision of the Opposition Division that the submission of one bill of lading showing the delivery of 40 packages of sherry is insufficient to prove genuine use.
Decision of 09/02/2012, R 0239/2011-1, GOLF WORLD (B 1 456 443, Golf World)	As the only evidence of use for <i>printed matter</i> , the opponent submitted evidence which proved 14 subscribers for a magazine in Sweden. The OD held that this is insufficient to prove genuine use in Sweden, particularly taking account of the fact that magazines are not high-priced articles.
R 2132/2010-2, SUSURRO (fig.)	Nine invoices concerning the sale of wine in 2005, 2006, 2007 and 2008 showing that over a period of 36 months goods marketed under the earlier mark and worth EUR 4 286.36 were sold, as well as an undated sample of a product label were not considered as sufficient proof of genuine use of a Spanish trade mark registered for 'alcoholic drinks (except beers)' in Class 33. The evidence showed that the sales of wine had been made in a small, very provincial, part of Spain. For a country with over 40 million inhabitants, the amount sold of a relatively cheap wine was found to be too small to create or preserve an outlet for goods (wine) that are consumed in large quantities by the average Spanish consumer.
Decision of 07/07/2011, R 0908/2010-2, ALFA-REN	Table of sales figures for ALFACALCIDOL products in Lithuania between 2005 and 2008, indicating products sold by Teva Corp. under the trade mark 'ALPHA D3' (source: IMS health database, Lithuania); an undated copy of packaging for a product 'ALPHA D3' (undated); and a copy of an advertisement for 'ALPHA D3' products sold in Lithuania (not translated) were found insufficient to show genuine use of the mark in Lithuania. It could not be seen from the evidence submitted whether the marked goods were actually distributed and, if so, the quantities involved.
Decision of 16/03/2011, R 0820/2010-1, BE YOU	Sales of goods with profits below EUR 200 during the 9-month period of use were not considered sufficient proof of genuine use of the opposing mark in respect of the goods in Class 14.

Case No	Comment
Decision of 06/04/2011, R 0999/2010-1, TAUTROPFEN CHARISMA (fig.)	Eleven invoices showing that 13 units of 'perfumery' goods were sold in Spain between 2003 and 2005, for a total amount of EUR 84.63, were deemed as insufficient proof of genuine use of the sign. Account has been taken of the fact that the goods were intended for daily use and available at a very affordable price.
Decisión of 27/10/2008, B 1 118 605, Viña la Rosa	Photocopies of three independent wine guides mentioning the opponent's trade mark (without further explanation as to the volume, edition, publisher, etc.) were not considered sufficient to prove use for wines.
Decision of 21/06/1999, B 70 716, Oregon	The Opposition Division found an invoice for 180 pairs of shoes as insufficient to prove genuine use.
Decision of 30/01/2001, B 193 716, Lynx	As evidence of use the opponent filed two invoices for a total amount of 122 items of clothing and four undated labels with no indication of what goods they were to be affixed to. The Opposition Division considered them insufficient.

2.6.3 Examples of sufficient use

Case No	Comment
Judgment of 16/11/2011, T-308/06, Buffalo Milke, EU:T:2011:675, § 68	Nine invoices dated between April 2001 and March 2002 representing sales of around EUR 1 600 (with a turnover figure barely above EUR 1 000 000 per year) and showing that items were delivered to different customers in small quantities (12, 24, 36, 48, 60, 72 or 144 pieces), for widely-used products like shoe polish, in the largest European market, Germany, with approximately 80 million potential consumers, were deemed as providing evidence of use that objectively is such as to create or preserve an outlet for polishing cream and leather conditioner. Furthermore, the volume of sales, in relation to the period and frequency of use, was deemed to be significant enough not to be concluded as merely token, minimal or notional for the sole purpose of preserving the rights conferred by the mark. Confirmed by the GC.
Judgment of 10/09/2008, T-325/06, Capio, EU:T:2008:338, § 48, 60	Evidence (invoices, lists of sales) proving that the intervener sold 4 hollow-fibre oxygenators with detachable hard-shell reservoirs in Finland in 1998, 105 in 1999 and 12 in 2001, for a total amount of EUR 19 901.76, was deemed sufficient proof of genuine use of the CTM registered for 'oxygenators with integrated pump; controllers for integrated pump; regulating devices of air pressure for integrated pump; suction pumps; blood flow meters', in Class 10.
Judgment of 27/09/2007, T-418/03, La Mer, EU:T:2007:299, § 87-90	Ten invoices over a period of 33 months, regarding several product ranges, the packaging of which bears the trade mark concerned, with numbers very far apart (22 214 for the invoice of 3 January 1995, 24 085 for that of 4 May 1995, 24 135 for that of 10 May 1995 and 31 348 for that of 26 March 1997), showing that the sales were made to different persons, were deemed as permitting the inference that they had been submitted merely by way of illustration of total sales but not as showing that the trade mark was used publicly and outwardly rather than solely within the undertaking that owned the earlier trade mark or within a distribution network owned or controlled by that undertaking. Nevertheless, the sales effected, while not considerable, were deemed as constituting use that objectively was such as to create or preserve an outlet for the products concerned and entailing a volume of sales that, in relation to the period and frequency of use, was not so low as to allow the conclusion that the use was merely token, minimal or notional for the sole purpose of preserving the rights conferred by the mark.

Case No	Comment
Judgment of 25/03/2009, T-191/07, Budweiser, EU:T:2009:83	The Board of Appeal (decision of 20/03/2007, R 0299/2006-2 – ‘BUDWEISER/earlier international word mark BUDWEISER’, § 26) found, essentially, that the documents presented to it during the administrative proceedings – invoices proving the sale of beer in France amounting to more than 40 000 litres between October 1997 and April 1999, 23 invoices issued in Austria between 1993 and 2000 to a single buyer in Austria, and 14 invoices issued in Germany between 1993 and 1997 – were sufficient to demonstrate the extent of use of the earlier international word mark BUDWEISER (IR No 238 203) in those countries. The Board’s findings were confirmed by the GC.
Judgment of 11/05/2006, C-416/04 P, Vitafruit, EU:C:2006:310, § 68-77	Evidence of the sale to a single customer in Spain of concentrated fruit juices during a period of eleven and a half months with a total volume of sales of EUR 4 800, corresponding to the sale of 293 cases of 12 items each, was considered sufficient use of the earlier Spanish trade mark.
Judgment of 08/07/2010, T-30/09, Peerstorm, EU:T:2010:298, § 42-43	As evidence of use, the opponent (merely) provided several catalogues for end consumers, featuring the relevant trade mark on clothing articles. The Court held that ‘...it is true that those catalogues provide no information on the quantity of goods actually sold by the intervener under the trade mark PETER STORM. However, it is necessary to take into account ... the fact that a large number of items designated by the trade mark PETER STORM were offered in the catalogues and that those items were available in more than 240 shops in the United Kingdom for a significant part of the relevant period. Those factors support the conclusion, in the context of a global assessment ... that the extent of its use was fairly significant.’
Decision of 04/09/2007, R 0035/2007-2, DINKY	The sale of approximately 1 000 miniature toy vehicles was considered sufficient extent of use in light of the products being sold mainly to collectors at a high price in a particular market.
Decision of 11/10/2010, R 0571/2009-1, VitAmour	The sale of 500 kg of milk proteins for a total value of EUR 11 000 was considered sufficient to prove genuine use for <i>milk proteins for human consumption</i> . In view of the nature of the products, which are not consumer goods but ingredients for use by the food processing industry, the amount and values shown did demonstrate a market presence above the threshold required.
Decision of 27/07/2011, R 1123/2010-4, Duracryl	Eleven invoices made out to different undertakings in various regions of Spain, showing that the proprietor of the mark sold, in the relevant period and under the mark, 311 containers of the product, in different sizes, for a net amount of EUR 2 684, were deemed sufficient to prove genuine use of a mark registered for ‘preservatives against deterioration of wood’ in Class 2.
Decision of 01/02/2011, B 1 563 066	An annual turnover of more than EUR 10 million over several years was claimed for medical preparations. The corresponding invoices (one per relevant year) only proved actual sales of about EUR 20 per year. In an overall assessment, and in the context of further material submitted such as price lists, a sworn statement, packaging and advertising material, the Office found this sufficient to prove genuine use.
Decision of 26/01/2001, B 150 039	The Opposition Division regarded evidence of sales for around 2 000 furry toy animals in a high-priced market sector as sufficient.
Decision of 18/06/2001, B 167 488	The opponent submitted one invoice referring to the sale of one high-precision laser cutting machine for FRF 565 000, a catalogue describing its performance and some photographs depicting the product. The Opposition Division considered them as sufficient evidence taking into account the nature of the product, the specific market and its considerably high price.

2.7 Use of the mark in forms different from the one registered

2.7.1 Introduction

Article 15 CTMR states that use of the mark in a form different from the one registered still constitutes use of the trade mark as long as the differing elements do not alter the distinctive character of the trade mark.

The purpose of this provision is to allow its proprietor to make variations in the sign which, without altering its distinctive character, enable it to be better adapted to the marketing and promotion requirements of the goods or services concerned (judgment of 23/02/2006, T-194/03, EU:T:2006:65, § 50).

The General Court (the 'GC') further mentioned that strict conformity between the sign as used and the sign registered is not necessary. However, the difference must be in negligible elements and the signs as used and registered must be broadly equivalent (judgment of 23/02/2006, T-194/03, *Bainbridge*, EU:T:2006:65, § 50).

In order to decide whether the sign as used and the sign as registered are broadly equivalent, it must first be established which elements are negligible. The GC has developed criteria for doing so in several judgments.

Paragraph 2.7.2 will deal with these criteria. Paragraph 2.7.3 will describe Office practice in relation to the 'variation' of marks, 'additions' of elements to marks and 'omissions' of elements of marks.

Finally, it should be noted that, in order to establish use of the trade mark for the purposes of Article 15(1)(a) CTMR, the proprietor of a registered trade mark is not precluded from relying on the fact that it is used in a form that differs from the form in which it was registered, without the differences between the two forms altering the distinctive character of that trade mark, **even if that different form is itself registered as a trade mark** (judgment of 25/10/2012, C-553/11, *Proti et al.*, EU:C:2012:3861, § 30).

2.7.2 Criteria of the Court

In brief, the test developed by the Court consists of first determining what the distinctive and dominant elements of the registered sign are and then verifying if they are also present in the sign as used.

The GC has held that:

the assessment of the distinctive or dominant character of one or more components of a complex trade mark must be based on the intrinsic qualities of each of those components, as well as on the relative position of the different components within the arrangement of the trade mark (judgment of 24/11/2005, T-135/04, *Online Bus*, EU:T:2005:419, § 36).

With regard to **additions**:

- several signs may be used simultaneously without altering the distinctive character of the registered sign (judgment of 08/12/2005, T-29/04, Cristal Castellblanch, EU:T:2005:438, § 34);
- if the addition is not distinctive, is weak and/or is not dominant, it does not alter the distinctive character of the registered trade mark (judgments of 30/11/2009, T-353/07, Coloris, EU:T:2009:475, § 29-33 *et seq.*; 10/06/2010, T-482/08, Atlas Transport, EU:T:2010:229, § 36 *et seq.*).

With regard to **omissions**:

- if the omitted element is in a secondary position and not distinctive, its omission does not alter the distinctive character of the trade mark (judgment of 24/11/2005, T-135/04, Online Bus, EU:T:2005:419, § 37).

2.7.3 Office practice

In general, it has to be assessed whether the use of the mark constitutes an acceptable or unacceptable 'variation' of its registered form.

Therefore, there are two questions to be answered. Firstly, it must be clarified what is to be regarded as the distinctive character of the mark as registered¹. Secondly, it must be evaluated whether the mark as used alters this distinctive character. These questions have to be answered on a case-by-case basis.

There is *interdependence* between the strength of the distinctive character of a mark and the effect of alterations. Marks of strong distinctive character may be less influenced by changes than marks of limited distinctiveness. Adding elements to or omitting elements from the mark are more likely to affect the distinctive character of marks of limited distinctiveness.

Where a mark is composed of *several elements*, only one or some of which are distinctive and have rendered the mark as a whole registrable, an alteration of that distinctive element(s) or its omission or replacement by another element will generally mean that the distinctive character is altered.

In order to determine whether the use of a variation of the mark should be accepted or whether the distinctive character is altered, account must be taken of the practices in the branch of business or trade concerned and the relevant public.

¹ See the Guidelines, Part C, Opposition, Section 2, Double identity and Likelihood of Confusion, Chapter 4, Comparison of Signs.

Case No	Registered mark	Actual use	Comment
T-105/13 TrinkFix	Drinkfit		Relevant goods were beverages in Classes 29 and 32. The labels on bottles of beverages are narrow, so it is not unusual to write one word mark in two lines (paragraph 47).

The following paragraphs contain a number of practical guidelines for assessing whether additions (paragraph 2.7.3.1), omissions (paragraph 2.7.3.2) and alterations (paragraph 2.7.3.3) in the form of the sign as used alter the distinctive character of the registered trade mark.

2.7.3.1 Additions

As indicated above, with regard to additions, (i) several signs may be used simultaneously without altering the distinctive character of the registered sign and (ii) if the addition is non-distinctive or weak and/or not dominant, it does not alter the distinctive character of the registered trade mark.

The following paragraphs provide examples of these two types of scenarios:

- use of several signs simultaneously;
- additions of other verbal elements;
- additions of figurative elements.

Use of several marks or signs simultaneously

It is quite common in some market areas for goods and services to bear not only their individual mark, but also the mark of the business or product group ('house mark'). In these cases, the registered mark is not used in a different form, but the two independent marks are validly used at the same time.

There is no legal precept in the Community trade mark system that obliges the opponent to provide evidence of the earlier mark alone when genuine use is required within the meaning of Article 42 CTMR. Two or more trade marks may be used together in an autonomous way, or with the company name, without altering the distinctive character of the earlier registered trade mark (T-463/12, MB, EU:T:2014:935, § 43). It is common practice in the trade to depict independent marks in different sizes and typeface, so these clear differences, which emphasise the house mark, indicate that two different marks are used jointly but autonomously (decision of 07/08/2014, R 1880/2013-1, HEALTHPRESSO/PRESSO, § 42).

The Court has confirmed that the condition of genuine use of a registered trade mark may be satisfied both where it has been used as part of another composite mark or where it is used in conjunction with another mark, even if the combination of marks is itself registered as a trade mark (judgment of 18/04/2013, C-12/12, SM JEANS/LEVI'S, EU:C:2013:253, § 36.). Similarly, the Court has clarified that use can be genuine where

a figurative mark is used in conjunction with a word mark superimposed over it, even if the combination of those two marks is itself registered, to the extent that the differences between the form in which that trade mark is used and that in which it was registered do not change the distinctive character of that trade mark as registered (judgment of 18/07/2013, C-252/12, Specsavers, EU:C:2013:497, § 31).

Registered form	Actual use	Case No
CRISTAL		T-29/04

'In the present case the mark CRISTAL appears clearly four times on the neck of the bottle marketed by the intervener and twice on the main label, accompanied by the symbol ®. On the neck, that mark is separate from the other elements. In addition, the mark CRISTAL appears alone on the boxes in which bottles of the mark CRISTAL are marketed. Equally, on the invoices produced by the intervener reference is made to the term "cristal" with the mention "1990 coffret". It should be noted that the mark CRISTAL thus identifies the product marketed by the intervener' (paragraph 35).

'As regards the mention "Louis Roederer" on the main label, it merely indicates the name of the manufacturer's company, which may provide a direct link between one or more product lines and a specific undertaking. The same reasoning applies to the group of letters "lr", which represents the initials of the intervener's name. As pointed out by OHIM, joint use of those elements on the same bottle does not undermine the function of the mark CRISTAL as a means of identifying the products at issue' (paragraph 36).

'Furthermore, OHIM's finding that the use of the word mark together with the geographical indication "Champagne" cannot be considered to be an addition capable of altering the distinctive character of the trade mark when used for champagne must be endorsed. In the wine sector the consumer is often particularly interested in the precise geographical origin of the product and the identity of the wine producer, since the reputation of such products often depends on whether the wine is produced in a certain geographical region by a certain winery' (paragraph 37).

'In those circumstances it must be held that the use of the word mark CRISTAL together with other indications is irrelevant and that the Board of Appeal did not infringe Article 15(2)(a) of Regulation No 40/94, Article 43(2) and (3) thereof, or Rule 22(2) of the implementing regulation' (paragraph 38).



Registered form	Actual use	Case No
L.114	Lehning L114	T-77/10 & T-78/10
<p>L.114 is a French trade mark registered for 'pharmaceutical products' in Class 5.</p> <p>The Court found that:</p> <p>1) the missing full-stop between the capital letter 'L' and the number 114 constituted a minor</p>		

2) difference that did not deprive earlier mark L.114 of its distinctive character (paragraph 53). 'Lehning' was **the house mark**. The fact that earlier mark 'L.114' was used together with **that** house mark did not alter its distinctive character within the meaning of Article 15(1)(a) CTMR' (paragraph 53).



Registered form	Actual use	Case No
YGAY	YGAY together with a number of other verbal and figurative elements	R 1695/2007-1 (confirmed by T-546/08)



In the Board's decision (confirmed by the Court in T-546/08, § 19, 20) it was pointed out that the trade mark YGAY appears in many photographs on both the label and the box in which the bottle is sold. On the labels, the trade mark in question is separated from the other elements. On some labels, it appears on its own, beneath the phrase MARQUES DE MURRIETA, written in large bold letters. On others, the phrase BODEGAS MARQUES DE MURRIETA is written in small letters in the upper part, while the elements CASTILLO YGAY are written in large, stylised letters across the label. The trade mark YGAY also appears on its own or together with the phrase CASTILLO YGAY on the boxes in which the bottles are sold. Reference is also made, on the invoices submitted by the opponent, to the trade mark YGAY, along with general information such as the year of production and origin, etc. It follows, therefore, that the sign YGAY functions as the trade mark identifying the goods, 'wine', sold by the opponent (paragraph 15).



The mention of MARQUES DE MURRIETA in this context might merely be an indication of the name of the manufacturer's company or the vineyard that produces and sells the wine, which might provide a direct link between one or more product lines and a specific undertaking (judgment of Court of First Instance (CFI) of 08/12/2005, T-29/04, Cristal Castellblanch, EU:T:2005:438, § 36) (§ 16).

Registered form	Actual use	Case No
 <p>Mark No 1</p>	 <p>Mark No 2</p>	C-12/12

Levi Strauss is the proprietor of the two CTMs reproduced above. Mark No 1 is always used in conjunction with the word mark LEVI'S, i.e., as in Mark No 2. The Court found that the condition of 'genuine use' may be fulfilled where a Community figurative mark is used only in conjunction with a Community word mark that is superimposed over it, and the combination of those two marks is, furthermore, itself registered as a Community trade mark, to the extent that the differences between the form in which that trade mark is used and that in which it was registered do not change the distinctive character of that trade mark as registered.

Registered form	Actual use	Case No
		C-252/12

Specsavers commenced proceedings for trade mark infringement and passing off on the basis of the earlier CTMs SPECSAVERS (word mark), as well as the figurative signs  ,  and  , against ASDA, a supermarket chain which relaunched its optical business and targeted Specsavers in its marketing campaign. Specsavers used in colour its B&W registrations and acquired

reputation in the UK for the colour green, using its sign as follows: . ASDA also acquired reputation in the UK for another shade of green in its supermarket business and applied it to the optical business: .

The Court found that the use of  with the superimposed word sign may be considered genuine use of the wordless logo mark to the extent that the wordless logo mark as it was registered always refers in that form to the goods of the Specsavers group (to be determined by the referring court) (paragraph 24).

It is up to the opponent **to provide evidence** that the additional sign is in fact an independent mark or sign, which refers, for instance, to the company mark, the manufacturer, etc.

Registered form	Actual use	Case No
MINUTO	DUBOIS MINUTO	R 0206/2000-3
<p>The Board of Appeal regarded the presentation of the two words as the use of two separate marks, since the evidence submitted by the opponent showed that one of them was an old brand of the opponent with its own identity and that this mark was present on the market with a number of accompanying signs, as is common practice in the labelling of the specific products (wine).</p> <p>'DUBOIS' and 'MINUTO' are separate marks that are affixed together in the concrete product, as is common practice in the labelling of wine products (name of the winery and name of the product). As regards Spanish brands, see for example 'TORRES' – 'Sangre de Toro', 'TORRES' – 'Acqua d'Or'. When asking for 'MINUTO' wine, the relevant consumer will be aware that such wine is included within the line of products 'DUBOIS', however, 'MINUTO' will be perceived as a trade mark of its own, even if it may appear next to the sign 'DUBOIS' in the invoices, brochures and/or product labels' (paragraph 18).</p>		

On the other hand, the genuineness of use could be put into doubt in cases where used together with another mark, the registered mark is perceived as a **mere decorative element**.

Addition of other verbal elements

In principle, a difference in words or even letters constitutes an alteration of the distinctive character of the mark. However, in the following three paragraphs a number of situations are described where additions are acceptable. The fourth paragraph provides examples of unacceptable additions.

Addition of non-dominant el

Registered form		
COLORIS		T-353/07 T-353/07
<p>The GC confirmed that the use of the mark <i>Coloris</i> with additional word elements such as 'global coloring concept' or 'gcc' did not alter its distinctive character because the additional elements were merely used together with the mark <i>Coloris</i> and <u>positioned below it</u> and were of such a size that they were <u>not predominant</u> in that mark.</p> <p>The same finding applies with even greater force to the additional words (global coloring concept) as '<i>they are words with a general meaning and the word "coloring" refers to the goods concerned and, consequently, has a certain descriptive character</i>'.</p>		



Additions with generic or descriptive meaning

Use of a registered word mark (or any other mark) together with a generic indication of the product or descriptive term will be considered as use of the registered mark. Additions that are just indications of characteristics of the goods and services, such as their kind, quality, quantity, intended purpose, value, geographical origin or the time of production of the goods or of rendering of the services, do not in general constitute use of a variant but use of the mark itself.

For example:

INTERNATIONAL TRADEMARK ASSOCIATION

Registered form	Actual use	Case No
HALDER	HALDER I, HALDER II, HALDER III, HALDER IV, HALDER V	T-209/09
<p>The Court indicated that 'the fact that, in that newspaper article, the names of the funds are composed of the term "halder", to which a number in Roman numerals has been added, is not such as to call into question the conclusion on use of the mark, since, because of their brevity, their weak distinctive character and their ancillary position, those additions do not alter the distinctive character of the mark in the form in which it was registered' (paragraph 58).</p>		

Registered form	Actual use	Case No
		<p>R 1190/2011-4</p>
<p>The figurative signs reproduced in the evidence of use contain the distinctive elements of the earlier mark and those elements are clearly visible on the labels. The inversion of the figurative and word elements of the sign and the additional indication of the respective appellation of origin (Soave, Soave Superior and Chianti) do not alter the distinctive character of the earlier mark, which appears reproduced in the sign with all its distinctive elements. Consumers of wines are particularly interested in knowing the precise geographical origin of these products; however, the addition of this information about the geographical origin of the goods is not capable of altering the distinctive character of a trade mark in its essential function of identifying a particular commercial origin (judgment of 08/12/2005, T-29/04, Cristal Castellblanch, EU:T:2005:438, § 19).</p>		

Other acceptable additions

The addition of **insignificant elements** such as punctuation marks does not alter distinctive character:

Registered form	Actual use	Case No
PELASPAN-PAC	PELASPAN PAC	R 1986/2011-4
<p>The use of the earlier mark 'PELASPAN-PAC' without the hyphen connecting the elements 'PELASPAN' and 'PAC' does not alter the distinctive character of the earlier mark as registered and therefore counts for the genuine use assessment.</p>		

In the same way, the use of **plural or singular forms** or vice versa in meaningful words (for instance, by adding/omitting a letter 's' in English or other languages) normally does not alter distinctive character:

Registered form	Actual use	Case No
Tentation	Tentations	R 1939/2007-1
<p>'In the present case, and after examination of the evidence submitted, which focuses essentially on the Spanish market, the Board is of the opinion that use of the registered trade mark "TENTATION" through use of the sign "TENTATIONS" does not alter the distinctive character of the original registered trade mark. Specifically, the mere addition of the letter "S" to the end of the trade mark neither substantially alters the visual appearance or pronunciation of the registered trade mark nor creates a different conceptual impression on the Spanish market. The trade mark in question will be perceived merely as being in the plural instead of the singular. Therefore, this change does not alter the distinctive character of the sign' (paragraph 17).</p>		

The addition of the **'type of enterprise'** is also acceptable:

Registered form	Actual use	Case No
	<p>The form used contained the logo plus the words 'SOCIEDAD LIMITADA' (in small letters) underneath the term 'SISTEMAS' and/or the 'E' device with the words 'epco SISTEMAS, S.L.' in bold</p>	<p>R 1088/2008-2 Confirmed by T-132/09</p>
<p>'... these signs are not, as the applicant seems to suggest, significant alterations of the distinctive character of the earlier mark as registered' (paragraph 24).</p>		

Unacceptable additions



Registered form	Actual use	Case No
VILA VITA PARC	vila vita hotel & feriendorf panno[n]ia	T-204/12
<p>'whereas the German word "Feriendorf", meaning "holiday village", can be perceived as having a descriptive character for the relevant [hotel] services, this does not apply to the word element "panno[n]ia" (paragraph 30). Consequently, the addition of the word 'panno[n]ia' alters the distinctive character of the mark.</p>		

Registered form	Actual use	Case No
Captain	Captain Birds Eye	R 0089/2000-1
<p>'It cannot be considered ... that the use of CAPTAIN BIRDS EYE constitutes use of the mark CAPTAIN in a form which does not alter the distinctive character of the mark as registered, since the two signs appear essentially different' (paragraph 20).</p>		

Addition of figurative elements

In cases where the figurative element plays only a minor role, being merely decorative, the distinctive character of the sign as registered is not affected.

Registered form	Actual use	Case No
DRINKFIT		T-105/13
<p>The addition of the circular graphical element does not change the overall impression of the sign (paragraph 49).</p>		



Registered form	Actual use	Case No
SEMBELLA		T-551/12
The figurative elements are only decorative or even negligible and do not alter the distinctive character of the mark (paragraph 43).		
BIONSEN		R 1236/2007-2
<p>'Moreover, this material shows that the respondent's products also contain other elements, in particular a Japanese character within a small circle, which is depicted either above or below the word "BIONSEN" (paragraph 19).</p> <p>'However, in the present case, the combination of the stylised form of the word "BIONSEN" and the Japanese character, independently of whether it is above or under the word "BIONSEN", constitutes at the most use which differs from the form in which it was registered only in negligible elements. The word "BIONSEN" as used is merely a slight and banal stylisation of the word 'BIONSEN'. As to the addition of the figurative element in the form of a circular element with a Japanese character, this will hardly be noticed by the average consumer due to its relatively small size and position, either under or on the right side above the word "BIONSEN" (paragraph 23).</p>		

2.7.3.2 Omissions

When considering 'omissions' of elements of a mark in its used form, care has to be taken to check that the distinctive character of the mark has not been altered.

If the omitted element is in a **secondary position and not distinctive**, its omission does not alter the mark (judgment of 24/11/2005, T-135/04, Online Bus, EU:T:2005:419).

Omissions of non-dominant elements



Registered form	Actual use	Case No
		T-135/04
<p>The GC considered that both the registered form of the earlier mark and the form used included the word 'BUS' and the figurative element of 'three interlaced triangles'. The presentation of the elements is not particularly original or unusual in either form. The variation in them does not affect the distinctive character of the trade mark. As regards the omission of 'Betreuungsverbund für Unternehmer und Selbständige e.V.', the latter was 'a string of words, written in small characters and occupying a secondary position, at the bottom of the sign. Its meaning (Association for the assistance of businessmen and the self-employed, registered association) refers to the services in question. Therefore, in the light of the descriptive content of that element and its accessory position in the presentation of the sign, it must be held that it is not distinctive ... It follows from the foregoing that the form used of the earlier trade mark</p>		

used does not contain any differences such as to alter the distinctive character of that trade mark' (paragraph 34 *et seq.*).

Omissions of generic or descriptive elements

Where a registered mark contains a **generic** indication of the product or **descriptive** term, and this term is omitted in the used form of the sign, such use will be considered as use of the registered mark.

Omissions that are just indications of characteristics of the goods and services, such as their kind, quality, quantity, intended purpose, value, geographical origin or the time of production of the goods or of rendering of the services, in general constitute use of an acceptable variant.

Registered form	Actual use	Case No
		<p>T-415/09 (confirmed by C-621/11 P)</p>

The Board considered that although in *some pieces* of evidence the earlier mark did not include the word 'beachwear' *this does not alter the distinctiveness of the earlier mark because it is plainly descriptive of the nature of the goods* ('T-shirts, beachwear').

The GC held:



'In the present case, the earlier mark is a composite mark, representing a ship's wheel, that is to say, a sign with a rounded shape. In the centre of the sign there is a fish skeleton, at the top of which is written the term 'fishbone', and at the bottom the term "beachwear". ... [A]lthough the use of the earlier mark varies in certain items of evidence and is used in a form different from that under which it was registered, in the sense that the sign does not include the term 'beachwear', such a fact does not affect its distinctive character. **The term 'beachwear', which means 'beach clothing' in English, is descriptive of the nature of the goods covered by the earlier mark** [emphasis added]. That descriptive character is obvious in the case of the 'beach clothing' covered by the earlier mark, but also in the case of 't-shirts', for which the term 'beachwear' will immediately be perceived as meaning that it refers to a t-shirt to be worn in casual situations, for example, on the beach in summer. Consumers will thus understand that term as designating the type of goods and will not perceive it as an indication of their commercial origin. The fact that the term 'beachwear' is written in a more fanciful font than that of the term 'fishbone', which is written in ordinary capital letters, cannot alter such an assessment. Furthermore, the font of the term 'beachwear' cannot be regarded as uncommon, since it comprises printed lower-case characters. As for the horizontal position of the term 'beachwear' in the earlier mark, which runs in a perpendicular sense across the bottom of a ship's wheel, it is no more graphically incisive than that of the term 'fishbone' which, also written horizontally, follows the rounded shape of that wheel' (paragraphs 62-63).

Omissions

The omission of **insignificant prepositions** does not alter the distinctive character:

Registered form	Actual use	Case No
CASTILLO DE PERELADA	CASTILLO PERELADA	B 103 046
It is not considered that absence of use of the word 'de' affects the distinctive character of the trade mark.		

There are instances where the earlier sign is composed of a distinctive verbal element (or several) and a figurative element (or several), with the latter perceived by the relevant public as banal. Such banal elements are considered non-distinctive, and their omission does not change the distinctive character of the sign. Therefore, it is important to establish which elements influence the distinctive character of the mark and how consumers will perceive them.

Registered form	Actual use	Case No
		T-225/12, paragraphs 49-53 (appeal pending C-237/14P).
The Court confirmed (paragraph 53) the finding of the Board that 'distinctiveness of the mark is largely dominated by the wording "LIDL MUSIC" and only marginally influenced by the figurative elements used to represent the letters and the small monogram underneath' (decision of 21/03/2012, R 02379/2010-1, LIDL express (fig.)/LIDL MUSIC (fig.), paragraph 17).		



The omission of the **transliteration of a term** is generally considered as an acceptable alteration.

Registered form	Actual use	Case No
ΑΠΑΛΙΑ-ΑΠΑΛΙΑ	APALIA	R 2001/2010-1
The omission of the transliteration of the term in Greek characters does not alter the distinctive character of the mark as the form used contains the term APALIA, which is distinctive and dominant.		

Unacceptable omissions

In principle, a difference in **words or even letters** constitutes an alteration of the distinctive character of the mark.

Registered form	Actual use	Case No
TONY HAWK	HAWK 	B 1 034 208
'[T]he absence of the word element 'TONY' in the first two marks significantly alters the distinctive character of the registered earlier mark 'TONY HAWK'. Therefore, these marks shall be perceived as separate marks and their use cannot be considered as the use of the word mark 'TONY HAWK'.		

Registered form	Actual use	Case No
 (in Spain)		R 1625/2008-4 (appeal T-143/10 did not refer to the Spanish trade marks)
<p>'In the present case, the Board has been able to verify that none of the items of proof of use supplied reproduces the earlier Spanish signs in the form in which they were registered, since either the mark is represented in its purely visual form, that is, without the expression "light technology", or the visual element is accompanied only by the term "Light" and other word elements or the expression "LT Light-Technology", which is also in the form of a word lacking the visual element which obviously characterises the earlier Spanish marks on which the opposition is based ... Under these circumstances, and in view of the fact that the modifications made to the representation of earlier marks modify their distinctive character, it is considered that, in any case, the proof submitted does not demonstrate use of the Spanish marks on which the opposition is based' (paragraphs 15-16).</p>		

Registered form	Actual use	Case No
SP LA SPOSA	LA SPOSA LA SPOSA COLLECTION	R 1566/2008-4
<p>'The earlier trade mark is registered as "SP LA SPOSA". The documents submitted as proof of use refer only to female wedding dresses. The element "LA SPOSA" is a common term, which will be understood by the Italian and Spanish public as 'the bride' and has a weak distinctive character for the goods in issue, namely wedding dresses. The opponent itself, in its price list "tarifa de precios" which is drafted in various official languages of the EC, translated this term into the respective languages; underneath the term "LA SPOSA", the terms "novia" are mentioned in the Portuguese version of the list, "bride" in the English version, "Braut" in the German version, and so on. This shows that even the respondent itself understands the term "LA SPOSA" as a reference to the consumer targeted, namely the bride' (paragraph 18).</p> <p>'Therefore the element "SP" at the beginning of the earlier mark is a distinctive element and cannot be disregarded. This element cannot be neglected, first and foremost as it is placed at the beginning of the mark. Also, it is meaningless and distinctive on its own, in all the languages of the European Community' (paragraph 19).</p> <p>'[T]he omission of the letter "SP" in the word "LA SPOSA" or "LA SPOSA COLLECTION" is not an acceptable variation of the earlier mark but a significant modification to the distinctive character of the mark. The documents submitted by the respondent are insufficient to prove that the mark "SP LA SPOSA" has been put to genuine use' (paragraph 26).</p>		

In cases where the **figurative element** is the dominant or distinctive element and not merely decorative or banal, its omission can alter the distinctive character of the sign.

Registered form	Actual use	Case No
	ESCORPION	R 1140/2006-2
<p>'The earlier trade marks are strongly characterised by the presence of the figurative element. However, the documents submitted during the opposition proceedings and, even if they were to be taken into account, the appeal proceedings, do not show any use of the figurative element contained in the earlier trade marks' (paragraph 19).</p> <p>'Therefore, the Office considers that the alteration of the opponent's trade mark appearing in the way it is currently used is not an acceptable alteration and consequently use of the registered mark is not shown.</p>		

The opponent has not complied with the requirements of Article 43(2) and (3) CTMR and thus the opposition must be rejected, as far as it was based on the Spanish trade mark registrations' (paragraph 20).

2.7.3.3 Other alterations

Acceptable alterations

Word marks

Word marks are considered used as registered regardless of typeface, use of upper/lower case or colour. It would not be correct to analyse this type of use from the perspective of whether distinctive character is altered. However, a **very particular typeface** (highly stylised) may lead to a different conclusion.

Changing the **letter size** or switching between **upper/lower case** is customary when using word marks. Therefore, such use is considered use of the registered mark.

Registered form	Actual use	Case No
PALMA MULATA		T-381/12
The Court confirmed that the use of a [standard] typeface does not alter the distinctive character of a word mark. It rather helps to distinguish the mark from the descriptive elements 'ron' and 'de Cuba' (paragraph 34).		

Registered form	Actual use	Case No
MILENARIO		R 0289/2008-4
The Board confirmed OD's views that use of the word mark 'MILENARIO' written in stylised bold characters did not affect the distinctive character of the mark, as the word 'MILENARIO' was considered to be the dominant element of the mark registered for 'sparkly wines and liquors' in Class 33 (paragraph 13).		

Registered form	Actual use	Case No
AMYCOR		R 1344/2008-2
Representation of the word mark, registered for 'pharmaceutical and sanitary preparations; plasters; materials for dressings; fungicides; disinfectants' covered by the earlier trade mark in Class 5, in a stylised form together with figurative elements was not considered as substantially changing the distinctive character of the word trade mark 'AMYCOR' as registered.		

Registered form	Actual use	Case No
THE ECONOMIST		R 0056/2011-4
<p>'The applicant's argument that the proof of use is insufficient because it refers to the device mark ... and not to the word mark 'THE ECONOMIST' fails. First, the submitted evidence refers to both earlier marks (<i>i.e.</i> the word mark and the device mark). Furthermore, use of the earlier device mark constitutes use of the earlier word mark. In this respect it should be noted that word marks are considered used as registered, also if the typeface is different (this may be different if the typeface is a very particular one), if there is a usual change in the letter size or a usual change between lower-case and capital letters, if used in a specific colour or if used in combination with generic additions. Use of the word "THE ECONOMIST" in a standard typeface, with the usual use of capitals at the beginning of the words "The" and "Economist", in a white colour on a contrasting background is considered use, not only of the earlier device mark but of the earlier word mark as well' (paragraph 14).</p>		

Word marks are registered in black and white. It is customary to use marks in **colour**. Such use does not constitute a variant but use of the registered mark.



Registered form	Actual use	Case No
BIOTEX	(various)	R 0812/2000-1
<p>'The mark, as shown in those documents, has been variously depicted in the following styles:</p> <ul style="list-style-type: none"> – The word BIOTEX in white block capitals on a dark background in advertisements. – Reference in newspaper articles to the word BIOTEX in plain typeface. – The word BIOTEX in white block capitals with the top-most point of the letter "I" in darker colouring. – The word BIOTEX in plain block white capitals on the labels and packaging of detergent products. – The word BIOTEX in plain typeface on shipping invoices. – The word BIOTEX in white upper and lower cases block letters on a darker background incorporating a figurative "wave" device' (paragraph 14). <p>'The evidence of use shows the mark has remained, in spite of various stylistic changes, essentially BIOTEX. The letters forming the mark have in general been mere block capitals, lacking anything fanciful. Sometimes the capitals are plain and two-dimensional, at other times they are shadowed to give the impression of being three-dimensional. Sometimes the letter "I" has a different colour tip. The Board considers these variations minimal and routine and that they demonstrate a practice that is commonplace not only in the particular business field of relevance here, but in other fields also. The Board does not consider that these variations invalidate use of the mark BIOTEX and therefore the contested decision must be annulled at this point' (paragraph 17).</p>		

Registered form	Actual use	Case No
SILVER		B 61 368
<p>'The actual use of the trade mark which can be seen on the beer pack, the newspaper extract and on the calendar is not the use of the registered <i>word</i> mark SILVER, but of the <i>colour device</i> mark, namely a beer label with the word SILVER written in white capital letters in a red banner which overlaps a golden circle which contains the word elements "Bière sans alcool", "Bière de haute qualité", "pur malt" and "Brassée par le Brasseries Kronenbourg". This does not automatically mean that the mark was not used as registered. Each case must be looked at on its own merits. In this case, the Office finds that the mark SILVER is the actual trade mark. The appearance of the other word elements "Bière sans alcool", "Bière de haute qualité", "pur malt" and "Brassée par le Brasseries Kronenbourg" and the figurative element is only secondary to the mark SILVER. It is also clear from the marketing study, the newspaper extract and the invoices that the actual trade mark is SILVER. The Office finds that the use of the word SILVER is so dominant in the figurative mark that it fulfils the requirements of having been used as registered.'</p>		

Figurative marks

Using a **purely figurative mark** (without word elements) in a form other than registered often constitutes an unacceptable alteration.

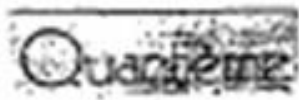
In the case of **composite marks** (i.e. marks composed of word and figurative elements), **changes to certain figurative elements** *do not* normally affect the distinctive character of the marks.

Registered form	Actual use	Case No
		T-147/03 (C-171/06 P dismissed)
<p>'[T]he only elements which differentiate the earlier national mark, as it was registered, from the sign used by the applicant are the stylisation of the letter "q", suggesting the face of a watch, and the use of capital letters to write the verbal element of the earlier national mark ... In the first place, although it is true that the stylisation of the letter "q" is more pronounced in the representation of the sign used than in that of the earlier national mark, the distinctive character of the earlier mark is still based on the entire verbal element of that mark. In any case, since the stylisation of the letter "q" suggests, as has just been said, the face of a watch, it is not particularly distinctive for goods in Class 14, the only goods for which the applicant has furnished proof of use of the earlier mark. In the second place, as regards the use of capital letters, it suffices to note that that is not at all original and also does not alter the distinctive character of the earlier national mark ... It follows that the proof furnished by the applicant which refers to the sign reproduced in paragraph 10 above for the Class 14 goods "watches and watch bands or straps" could legitimately be taken into account by the Board of Appeal for the purposes of assessing whether the applicant had shown genuine use of the earlier national mark' (paragraphs 28-30).</p>		



This is particularly relevant in cases where the figurative element is *mainly descriptive* of the relevant goods and services.



Registered form	Actual use	Case No
GRECO TAVERNA		R 2604/2011-1
<p>'In relation to the "FETA" product, as regards the two Greek flags next to the word "TAVERNA" it should be noted that the obligation of using a trade mark as registered does not require its proprietor to use the mark in isolation in the course of trade. Article 15(1) CTMR does not preclude the possibility of the trade mark's proprietor adding further (decorative or descriptive) elements, or even other marks such as its house mark on the packaging of the product, as long as the trade mark 'as registered' remains clearly recognisable and in an individual form. The two Greek flags do not possess any distinctive character in relation to the products at hand which are commonly known to be food specialities originating from Greece. This is supported by the whole get-up of the product, coloured in blue and white in accordance with the colours of the Greek flag, the depiction of scenery which calls to mind a Mediterranean scene and the symbol for a Protected Designation of Origin below the picture' (paragraph 39).</p>		



This is also the case where the dominant elements remain unchanged (see T-135/04, 'Online bus' above).

As regards specifically **alterations in colour**, the main question that needs to be addressed is whether the mark as used alters the distinctive character of the registered mark, i.e. whether use of the mark in colour, while being registered in black and white or greyscale (and vice versa) constitutes an alteration of the registered form. The Office and a number of Trade Mark Offices of the European Union have agreed on a common practice under the European Trade Mark and Designs Network whereby a change only in colour does not alter the distinctive character of the trade mark as long as:

- the word/figurative elements coincide and are the main distinctive elements;
- the contrast of shades is respected;
- the colour or combination of colours does not have distinctive character in itself;
- the colour is not one of the main contributors to the overall distinctiveness of the sign.

Registered form	Actual use	Case No
		T-152/11
<p>The Court took the view that, if no colour is claimed in the application, the use of different colour combinations 'must be allowed, as long as the letters contrast against the background.' The Court also noted that the letters M, A, D were arranged in a particular way in the CTM. Accordingly, representations of the sign which do not alter the arrangement of the letters, or the contrast of colour, constitute genuine use (paragraphs 41 and 45).</p>		

Registered form	Actual use	Case No
		R 1479/2010-2
<p>The word element was considered to be the dominant feature of the figurative mark, since it was in a central position and in large letters. It was considered that the distinctive character was not changed (paragraph 15).</p>		

Registered form	Actual use	Case No
		R 0877/2009-1
<p>'The orange background is the colour of packaging of the products. The mark is used in black on a white background, outlined in silver similar to the earlier registered mark. The typeface has been slightly modernised and the small hyphen between "Bi" and "Fi" has been deleted. Nevertheless, these may be considered as minor changes that do not alter the distinctive character of the mark in the form in which it is registered in the sense of Article 15(1)(a) CTMR. The typeface has been modernised but the letters keep their rounded shape and the deletion of the hyphen may pass unnoticed. The distinctive character of</p>		

the earlier mark is still based on the large black letters “Bi Fi”, the “B” and “F” being in capital letters and the two “i” letters in lower case, on a white background and outlined in silver’ (paragraph 45).

3D marks

The use of a 3D mark in varying sizes usually amounts to use of the mark as registered. The addition of a word/figurative element to such a mark does not generally alter the distinctive character of the sign.



Colour marks

Colour marks are marks consisting of one or more colours *per se*. Where the mark is a colour combination, the registration must indicate the proportion of each colour and specify how they will appear.

Colour marks must be used with the colours as registered. Insignificant variations in the colour shade and strength will not alter distinctive character.

Where a colour combination is registered without specifying the respective proportions, use in **varying proportions** will not affect distinctive character. The case is different when particular proportions were claimed and these are substantially altered in the variant as used.

Where a colour or colour combination is registered, use in combination with a **distinctive or descriptive word** will not affect distinctive character. See, by analogy, the Court judgment below regarding the proof of acquired distinctiveness of a mark (examination):



Registered form	Actual use	Case No
	(with word mark John Deere)	T-137/08 (AG case)
<p>‘The colours covered by the application for registration were designated using the Munsell system as: 9.47 GY3.57/7.45 (green) and 5.06 Y7.63/10.66 (yellow). The arrangement is described as being ‘green for the vehicle body and yellow for the wheels’, as is shown by a picture attached to the application and reproduced below  (paragraph 3).</p> <p>‘It follows from the above that, although it is true that the disputed mark was used and promoted in conjunction <u>with the word mark John Deere</u> [underlining added] and that the intervener’s advertising expenditure in the European Union was presented as a whole and not individually for each country, the applicant is wrong to claim that it was not proved to the required legal standard that the intervener had used the combination of the colours green and yellow on its goods as a trade mark and that the market penetration of its goods had been deep and long-lasting in all the Member States of the European Union as at 1 April 1996’ (paragraph 46).</p>		

Unacceptable alterations

Where a mark is composed of several elements, only one or some of which are distinctive and have rendered the mark as a whole registrable, an alteration of that

element or its omission or replacement by another element will generally mean that the distinctive character is altered.

Registered form	Actual use	Case No
MEXAVIT	MEXA-VIT C	R 0159/2005-4
In this case the use of the mark with a different spelling and the addition of the letter 'C' alter the distinctive character of the registered sign, because the letters 'VIT' are now seen as a descriptive element, namely 'VIT C' (which refers to 'Vitamin C').		

Registered form	Actual use	Case No
		R 2066/2010-4
<p>'[T]he 'NOVEDADES' catalogues dated 2004-2009 consistently show the mark  LLOYD'S and only this version. This does not constitute use of the mark [as registered] (with or without colour) as admissible under Article 15(1)(a) CTMR. The mere fact that both marks include a word element LLOYD'S is not enough for that purpose, also the figurative elements of the earlier mark must appear in the form as used. The form as used is in a different font, lacks the single letter L at the end and surrounded by an orbital device, and lacks the circular or orbital device around the word 'LLOYD'S'. In other words, all its figurative elements are missing in the form as used. On top, the form as used contains the conspicuous device of a flying bird with a long beak. The omission of all the figurative elements of the mark as registered and the addition of another figurative element does alter, in the form as used, the distinctive character of the mark and is much more than a mere variation or modernization' (paragraph 35).</p>		

2.8 Use for the goods or services for which the mark is registered

In accordance with Article 15 CTMR, the mark must be used for the goods or services for which it is registered in order to be enforceable. In accordance with the first sentence of Article 42(2) CTMR, the earlier registered mark must have been put to genuine use in connection with the goods or services in respect of which it is registered and which the opponent cites as justification for its opposition. The third sentence of Article 42(2) CTMR stipulates that if the earlier trade mark has been used for part only of the goods or services for which it is registered it will, for the purposes of the examination of the opposition, be deemed to be registered for only that part of the goods or services.

As the GC stated in the 'Aladin' case:

[The provisions of Article 42 CTMR] allowing an earlier trade mark to be deemed to be registered only in relation to the part of the goods or services in respect of which genuine use of the mark has been established (i) are a **limitation on the rights** which the proprietor of the earlier trade mark gains from his registration ..., and (ii) must be reconciled with the legitimate interest of the proprietor in being able in the future to **extend his range of goods or services**, within the confines of the terms describing the goods or services for which the trade mark was registered, by using the protection which registration of the trade mark confers on him. That is particularly so when, as here, the goods and services for which the trade mark has been registered form a sufficiently narrowly-defined category.

(Judgment of 14/07/2005, T-126/03, Aladin, EU:T:2005:288, § 51, emphasis added.)

The analysis of genuine use must in principle extend to all of the registered goods and/or services on which the opposition is based and for which the CTM applicant has made an explicit request for proof of use. However, in situations where it is clear that likelihood of confusion can be established on the basis of *some* of the earlier goods and/or services, the Office's analysis of genuine use need not extend to all the earlier goods and/or services but instead may focus on only those goods and/or services sufficient for establishing identity/similarity to the contested goods and/or services.

In other words, since likelihood of confusion can be established on the basis of a finding of genuine use for some of the earlier goods and/or services, it is unnecessary to examine the evidence of use filed by the opponent with respect to the remaining earlier goods and/or services.

The following sections include a number of guidelines to help establish whether the earlier trade mark has been effectively used for the registered goods and services. For further details see the Guidelines, Part C, Opposition, Section 2, Double identity and Likelihood of Confusion, Chapter 2, Comparison of Goods and Services and in particular the practice regarding the use of all the general indications in the class heading, and the Guidelines, Part B, Examination, Section 3, Classification.

2.8.1 Comparison between goods/services used and specification of goods/services

It must always be carefully assessed whether the goods and services for which the mark has been used fall within the category of the registered goods and services.

Examples:

Case No	Registered G&S	Used G&S	Comment
T-382/08, VOGUE	<i>Footwear.</i>	Retail of footwear.	Not OK (paragraphs 47-48).
T-183/08, SCHUHPARK	<i>Footwear.</i>	Retail services regarding footwear.	Not OK (paragraph 32)
R 0807/2000-3, Demara	<i>Pharmaceuticals, veterinary and disinfectant products.</i>	Napkins and napkin pants for incontinence.	Not OK, even though the specific goods might be distributed by pharmacies (paragraphs 14-16).
R 1533/2007-4, GEO MADRID	<i>Telecommunication services in Class 38.</i>	Providing an internet shopping platform.	Not OK (paragraph 16).
R 0068/2003-2, Sweetie	<i>Preserved, dried and cooked fruits and vegetables; concentrated citrus fruit and fruit extracts, preserves; sugar, biscuits, cakes, pastry and confectionery.</i>	Dessert toppings that are strawberry, caramel or chocolate flavoured.	Not OK (paragraph 20).
R 1519/2008-1, DODOT et al.	<i>Baby diapers of textile in Class 25.</i>	Disposable diapers of paper and cellulose (Class 16).	Not OK (paragraph 29).

Case No	Registered G&S	Used G&S	Comment
R 0594/2009-2, BANIF	<i>Administration, representation and general counsel</i> in Class 35 <i>Technical, economic and administrative projects</i> in Class 42.	Administration of funds and personal assets or real estate affairs (Class 36).	Not OK (paragraph 39).
B 1 589 871 OXIL	<i>Electric switches and 'parts of lamps'.</i>	Apparatus for lighting.	Not OK.
B 253 494 CAI/Kay	<i>Education services.</i>	Entertainment services.	Not OK.
B 1 259 136, LUPA	<i>Transportation and distribution services</i> in Class 39.	Home delivery of goods purchased in a retail store.	Not OK as the registered services are provided by specialist transport companies whose business is not the provision of other services, while the home delivery of goods purchased in a retail store is just an additional auxiliary service integrated in retail services.
R1330/2011-4, AF (fig.)	<i>Advertising, business management, business administration, office functions</i> in Class 35.	Retail services.	Not OK. If a trade mark is registered for the general indications in Class 35, but use is proven only for 'retail services' for particular goods, this cannot amount to valid proof of use for any of the specific indications of Class 35 or the class heading as a whole (paragraph 25 by analogy).

2.8.2 Relevance of the classification

It is relevant to establish whether the specific goods or services for which a mark has been used fall under any *general indication* listed in the *class heading* of a particular class of goods or services, and if so, which.

For instance, in Class 25, the class heading is 'clothing, footwear, and headgear' and each of these three items constitutes a 'general indication'. Whereas, in general, classification does not serve more than administrative purposes, it is relevant, in order to assess the nature of the use, to establish whether the goods for which a mark has been used fall under the general indication of 'clothing', 'footwear' or 'headgear'.

This is apparent when similar categories of goods have been classified differently for certain reasons. For instance, shoes have been classified in various classes according to their intended purpose: 'orthopaedic shoes' in Class 10 and 'ordinary' shoes in Class 25. It must be established, according to the evidence provided, to which kind of shoes the use relates.

2.8.3 Use and registration for general indications in 'class headings'

Where a mark is registered under *all or part of* the general indications listed in the class heading of a particular class and where it has been used for several goods or services that are properly classified in the same class under one of these *general indications*, the mark will be considered as having been used for that specific *general indication*.

Example: The earlier mark is registered for *clothing, footwear, headgear* in Class 25. The evidence relates to 'skirts', 'trousers' and 'T-shirts'.

Conclusion: The mark has been used for *clothing*.

On the other hand, when a mark is registered for only *part* of the *general indications* listed in the class heading of a particular class but has been used only for goods or services which fall under *another* general indication of that same class, the mark will not be considered as having been used for the registered goods or services (see also paragraph 2.8.4 below).

Example: The earlier mark is registered for *clothing* in Class 25. The evidence relates to 'boots' only.

Conclusion: The mark has not been used for the goods for which it is registered.

2.8.4 Use for subcategories of goods/services and similar goods/services

This part deals with the extent of protection granted where there is use for subcategories of goods and of 'similar' goods (or services).

In general, it is not appropriate to accept proof of use for 'different' but somehow 'linked' goods or services as automatically covering registered goods and services. In particular, the concept of **similarity of goods and services is not a valid consideration** within this context. The third sentence of Article 42(2) CTMR does not provide any exception in this regard.

Example: The earlier mark is registered for *clothing* in Class 25. The evidence relates to 'boots' only.

Conclusion: The mark has not been used for the goods for which it is registered.

2.8.4.1 Earlier mark registered for broad category of goods/services

In the Aladin case, the GC held:

if a trade mark has been registered for a category of goods or services which is sufficiently broad for it to be possible to identify within it a number of subcategories capable of being viewed independently, proof that the mark has been put to genuine use in relation to a part of those goods or services affords protection, in opposition proceedings, only for the subcategory or subcategories to which the goods or services for which the trade mark has actually been used belong.

(Judgment of 14/07/2005, T-126/03, Aladin, EU:T:2005:288, § 45.)

Therefore, if the earlier mark has been registered for a *broad category* of goods or services but the opponent provides evidence of use only for specific goods or services *falling within this category*, this raises the question of whether the submitted evidence is to be regarded strictly as proof of use only for the particular goods or services, which are not mentioned as such in the list of goods or services, or for the broad category as specified in the registration.

The GC further pointed out, on the one hand, that it is necessary to interpret the last sentence of Article 42(2) CTMR as seeking to deny a trade mark extensive protection if it has only been used in relation to part of the goods or services for which it is registered merely because it has been registered for a wide range of goods or services. Therefore, it is necessary to take account of the breadth of the categories of goods or services for which the earlier mark is registered, in particular the extent to which the categories concerned are described in general terms for registration purposes, and to do this in the light of the goods or services for which genuine use has actually been established (paragraph 44).

On the other hand, it is not necessary for the opponent to file evidence of all the commercial variations of similar goods or services but merely of those goods or services which are sufficiently distinct to constitute coherent categories or subcategories (paragraph 46). The underlying reason is that in practice it is impossible for the proprietor of a trade mark to prove that the mark has been used for all conceivable variations of the goods concerned by the registration.

Thus, protection is available **only** for the subcategory or subcategories to which the used goods or services belong if:

1. a trade mark had been registered for a **category** of goods or services:
 - (a) which is sufficiently broad to cover a number of subcategories other than in an arbitrary manner;
 - (b) that are capable of being perceived as being independent from each other;

and
2. it can be shown that the mark has been genuinely used in relation to only **part** of the initial broad specification.

Appropriate reasoning should be given for defining the subcategories and, on the basis of the evidence submitted by the opponent, it must be explained whether use has been shown in relation to only **part** of the initial broad specification/subcategory(ies). See examples in paragraph 2.8.4.3 below.

This is especially important in the case of trade marks registered for 'pharmaceutical preparations', which are usually used only for one kind of medicine for treating a certain disease (see the examples of pharmaceutical preparations in paragraph 2.8.4.3 below).

On the other hand, the use for a whole category has to be accepted if there are examples of different kinds of products belonging to this category and there is no other subcategory that covers the different products.

Contested sign	Case No
CARRERA	R 0260/2009-4 (revocation)
The proven use of a trade mark for: <ul style="list-style-type: none"> • decorative lettering; • increased performance packages; 	

- covers for storage compartments;
- wheel sets and complete wheel sets for summer and winter; and
- door sill cover plates

was considered sufficient proof of use for 'motor vehicle and land vehicle parts' overall, for which the mark was registered. The main arguments were that it was used for numerous different motor vehicle parts and the goods for which use had been proven thus covered a wide spectrum of motor vehicle parts: elements of the chassis, the bodywork, the engine, the interior design and decorative elements.

2.8.4.2 Earlier mark registered for precisely specified goods/services

In contrast, proof of genuine use of the mark for some of the specified goods or services necessarily covers the **entire category** if:

- (1) a trade mark has been registered for goods or services **specified** in a relatively precise manner; so that
- (2) it is not possible, without any artificiality, to make any significant subdivisions within the category concerned (judgment of 14/07/2005, T-126/03, Aladin, EU:T:2005:288, § 45).

The decision should duly indicate in which cases it is considered impossible to make subdivisions and, if necessary, why.

2.8.4.3 Examples

In order to define adequate subcategories of general **indications**, the **criterion of the purpose or intended use of the product or service** in question is of fundamental importance, as consumers do employ this criterion before making a purchase (judgments of 13/02/2007, T-256/04, Respicur, EU:T:2007:46, § 29-30; 23/09/2009, T-493/07, Famoxin, EU:T:2009:355, § 37). Other applicable criteria for defining adequate subcategories could be the characteristics of the product or service, for instance the nature of the product or service or the target consumer of the product or service.

Earlier sign	Case No
ALADIN	T-126/03
<p>G&S: polish for metals in Class 3.</p> <p><i>Assessment of PoU:</i> the earlier mark was registered for 'polish for metals' in Class 3, but was actually used genuinely only for 'magic cotton' (a product for polishing metals consisting of cotton impregnated with a polishing agent). The Court held that 'polish for metals', which in itself is already a subcategory of the class heading term 'polishing preparations', is sufficiently precise and narrowly-defined in terms of the function and intended purpose of the claimed goods. No further subcategory can be established without being artificial, and thus, use for the entire category of 'polish for metals' was assumed.</p>	

Contested sign	Case No
Turbo	R 0378/2006-2 Revocation
<p>G&S: clothing in Class 25.</p> <p><i>Assessment of PoU:</i> the Board found that, in addition to swimwear, other types of clothing were referred</p>	

to in the invoices and could be found in the catalogues. Thus, the Board found that use of the contested mark had been proved for 'clothing' (paragraph 22). The Board, moreover, found it almost impossible and certainly unduly onerous to impose on the proprietor of a registered CTM for 'clothing' the obligation to demonstrate use in all possible subcategories that could be endlessly subdivided by the applicant (paragraph 25).

Earlier sign	Case No
	<p>R 1088/2008-2 (confirmed by T-132/09)</p>
<p>G&S: measuring apparatus and instruments in Class 9.</p> <p><i>Assessment of PoU:</i> the mark was used for apparatus and parts thereof for the measurement of temperature, pressure and level. The contested decision considered that the original specification of the earlier mark for 'measuring apparatus and instruments' was a 'very wide' one, and determined, applying the criteria established in the Aladin judgment, that use had in fact only been shown for a subcategory of goods, namely: 'measuring apparatus, all being for the measurement of temperature, pressure and level; parts for the aforesaid apparatus'. The Board found that approach to be a reasonable one in the circumstances of the case and endorsed the reasoning and findings of the contested decision in this regard (paragraph 29).</p>	

Contested sign	Case No
<p>ICEBERG</p>	<p>R 1166/2008-1 Revocation</p>
<p>G&S: apparatus for heating, steam generating, refrigerating, drying, ventilating and water supply purposes in Class 11.</p> <p><i>Assessment of PoU:</i> the Board concluded that the trade mark use was only proven for fridges, freezers and air-conditioning modules for yachts and boats (paragraph 26). These goods were included in the subcategories 'apparatus for heating' (insofar as an air-conditioning machine can also perform as a heater), 'apparatus for refrigerating' (insofar as an air-conditioning machine, a fridge and a freezer can keep air/things cold), and 'apparatus for ventilating' (insofar as an air-conditioning machine, a fridge and a freezer all include ventilation circuits) for which the mark was registered. Therefore, the Board thought it should remain registered for those subcategories (paragraph 27). However, the Board did not consider it appropriate to limit the scope of protection of the trade mark to 'yachts and boats'. This would have further split the 'subcategories' and would amount to unjustified limitation (paragraph 28).</p> <p>Conclusion: use was considered proven for 'apparatus for heating, refrigerating and ventilating'.</p>	

Contested sign	Case No
<p>LOTUS</p>	<p>R 1295/2007-4 Revocation</p>
<p>G&S: outerwear and underwear, hosiery, corsets, neckties, braces, gloves, underclothes in Class 25.</p> <p><i>Assessment of PoU:</i> no evidence was submitted in respect of the goods 'corsets, neckties, braces'. None of the pieces of evidence submitted mentions these goods or refers to them. Use must be demonstrated for all goods or services in respect of which the trade mark is registered. The trade mark is registered for 'outerwear and underwear', but also for specific products within this category – inter alia 'corsets, neckties, braces'. Use for other goods is not sufficient to maintain protection under trade mark law for these goods, even if these other goods also fall under the category 'outerwear and underwear'. The Invalidity Division, however, considered use to be sufficient, because according to the principles of the Aladin judgment (judgment of 14/07/2005, T-126/03, Aladin, EU:T:2005:288) the 'corsets, neckties, braces' fall under the generic term of 'outerwear and underwear'. While this is indeed true, this question is subordinate to examining whether the goods used can be subsumed under the claimed term at all. This is not the case for 'corsets, neckties, braces'. If alongside the broad generic term the trade mark also explicitly claims specific goods covered by the generic term, it must also have been used for these specific goods in order to remain registered for them (paragraph 25).</p>	

Earlier sign	Case No
GRAF-SYTECO	R 1113/2009-4
<p>G&S: electric instruments (included in Class 9); optical, weighing, measuring, signalling and checking (supervision) instruments; data processing equipment and computers, in particular for operating, monitoring and checking machines, installations, vehicles and buildings; recorded computer programs; electronic counters in Class 9, repair services in Class 37 and computer programming in Class 42.</p> <p><i>Assessment of PoU:</i> the devices which the opponent has proven to have placed on the market fall under the wording of <i>hardware</i> as specified in Class 9. This is, however, a vast category, especially considering the massive development and high specialisation taking place in this field, which can be divided into subcategories according to the actual goods produced. In the present case the goods must be limited to the automotive industry. As the opponent is obliged to provide a legal guarantee to clients, it can be considered that it has also proven use of the service relating to repair of the hardware in question (Class 37). The Board also found that recorded computer programs in Class 9 were a very broad category and had to be limited to the actual field of activity of the opponent (paragraphs 30-31). No evidence was submitted for Class 42.</p>	

Earlier sign	Case No
HEMICELL	R 0155/2010-2
<p>G&S: foodstuffs for animals in Class 31, and animal foodstuffs, animal feed and non-medicated additives for animal feed; all included in Class 31.</p> <p><i>Assessment of PoU:</i> the contested decision erred in considering that the earlier mark had been put to genuine use for '<i>foodstuffs for animals</i>' in Class 31, and '<i>animal foodstuffs, animal feed and non-medicated additives for animal feed; all included in Class 31</i>', since this finding is contrary to the findings of the Court in ALADIN. The reason given by the contested decision is not acceptable because it should have been tested whether or not the category of goods covered by the earlier mark was susceptible of being divided into independent subcategories and whether the goods for which use of the earlier mark had been proven could be classified in one of those. Therefore, the Board considers that the earlier CTM is, for the purposes of examination of the opposition, deemed to be registered in respect of '<i>additives for animal feed</i>' only in Class 31.</p>	

Pharmaceutical preparations

In a number of cases, the Court had to define adequate subcategories for *pharmaceutical preparations* in Class 5. It held that the purpose and intended use of a therapeutic preparation are expressed in its therapeutic indication. Thus, the *therapeutic indication* is the key for defining the relevant subcategory of pharmaceutical products. Other criteria (such as dosage form, active ingredients, whether it is sold on prescription or over the counter) are irrelevant in this regard.

The following subcategories for *pharmaceutical preparations* were assumed to be adequate by the Court:

Case No	Adequate	Non-adequate
T-256/04, RESPICUR	<i>Pharmaceutical preparations for respiratory illnesses.</i>	<i>Multi-dose dry powder inhalers containing corticoids, available only on prescription.</i>
T-493/07, FAMOXIN	<i>Pharmaceutical preparations for cardiovascular illnesses.</i>	<i>Pharmaceutical preparations with digoxin for human use for cardiovascular illnesses.</i>
T-487/08 KREMIZIN	<i>Pharmaceutical preparations for heart treatment.</i>	<i>Sterile solution of adenosine for use in the treatment of specific heart condition, for intravenous administration in hospitals.</i>
T-483/04,	<i>Calcium-based preparations.</i>	<i>Pharmaceutical preparations.</i>

GALZIN		
--------	--	--

2.8.5 Use of the mark as regards integral parts and after-sales services of the registered goods

In the 'Minimax' judgment, the Court held that, in certain circumstances, use of the mark may be considered genuine also for 'registered' goods that had been sold at one time and were no longer available (judgment of 11/03/2003, C-40/01, Minimax, EU:C:2003:145, § 40 *et seq.*).

- This may apply where the proprietor of the trade mark under which such goods had been put on the market **sells parts** that are integral to the make-up or structure of the goods previously sold.
- The same may apply where the trade mark proprietor makes actual use of the mark for **after-sales services**, such as the sale of accessories or related parts, or the supply of maintenance and repair services.

Sign	Case No
Minimax	C-40/01
G&S: fire extinguishers and associated products v components and after-sales services.	
<p><i>Assessment of PoU:</i> the authorisation for the fire extinguishers sold by Ansul under the Minimax trade mark expired in the 1980s. Since then, Ansul has not been selling fire extinguishers under that mark. However, Ansul nonetheless sold component parts and extinguishing substances for fire extinguishers bearing the mark to undertakings with responsibility for maintaining them. During the same period it also maintained, checked and repaired equipment bearing the Minimax mark itself, used the mark on invoices relating to those services and affixed stickers bearing the mark and strips bearing the words 'Gebruiksklaar Minimax' (Ready for use Minimax) to the equipment. Ansul also sold these stickers and strips to undertakings that maintain fire extinguishers.</p>	

However, this finding of the Court should be interpreted **strictly** and applied only in very exceptional cases. In Minimax, the Court accepted use for goods other than those registered, which runs counter to the general rule laid down in Article 42(2) CTMR.

2.9 Use by the proprietor or on its behalf

2.9.1 Use by the proprietor

According to Articles 42(2) and 15(1) CTMR, it is in general the owner who has to put the earlier registered mark to genuine use. These provisions also cover use of the mark by the previous owner during its ownership (decision of 10/12/1999, case B 74 494).

2.9.2 Use by authorised third parties

According to Article 15(2) CTMR, use of the mark with the consent of the proprietor is deemed to constitute use by the proprietor. This means that the owner must have given its consent **prior** to the use of the mark by the third party. Acceptance later is insufficient.

A typical case of use by third parties is use made by **licensees**. Use by companies **economically related** to the trade mark proprietor, such as members of the same group of companies (affiliates, subsidiaries, etc.) is similarly to be considered as authorised use. Where goods are produced by the trade mark proprietor (or with its consent), but subsequently placed on the market by **distributors** at wholesale or retail level, this is to be considered as use of the mark (judgments of 17/02/2011, T-324/09, Friboi, EU:T:2011:47, § 32; 16/11/2011, T-308/06, Buffalo Milke, EU:T:2011:675, § 73).

At the **evidence** stage it is *prima facie* sufficient that the opponent only submits evidence that a third party has used the mark. The Office infers from such use, combined with the opponent's ability to present evidence of it, that the opponent has given prior consent.

This position of the Office was confirmed by judgment of 08/07/2004, T-203/02, Vitafruit, EU:T:2004:225, § 25 (and confirmed by the Court in C-416/04 P). The Court pointed out that it was unlikely that the proprietor of a trade mark would be in a position to submit evidence if the mark had been used against its wishes. There was all the more reason to **rely on that presumption**, given that the applicant did not dispute the opponent's consent.

However, if there are **doubts** on the part of the Office or, in general, in cases where the applicant explicitly contests the opponent's consent, the burden is on the opponent to submit further evidence that it gave its consent prior to use of the mark. In such cases the Office gives the opponent a further period of two months for the submission of such evidence.

2.9.3 Use of collective marks

Collective marks are generally used not by the proprietor but by members of an association.

According to Article 70 CTMR, use by (at least) one authorised person satisfies the user requirement, provided use is otherwise genuine.

The specific characteristic of collective trade marks is that their main objective is not to indicate that the goods or services originate from a specific source but that they originate from a certain region and/or comply with certain characteristics or qualities ('geographical and complementary indications of origin or quality'). This different function has to be taken into account when evaluating the proof of use in accordance with Article 70 CTMR.

Mere lists of persons authorised to use the collective mark and lists of products that are certified under the collective mark are generally not sufficient on their own to prove any genuine use (decisions of 25/05/2009, B 1 155 904; 24/02/2009, R 0970/2008-2, NFB).

2.10 Legal use

Whether a mark has been used in a way that satisfies the use requirements of Articles 15 and 42 CTMR requires a factual finding of genuine use. Use will be 'genuine' in this context even if the user violates legal provisions.

Use that is **deceptive** within the meaning of Article 7(1)(g) or Article 51(1)(c) CTMR or under provisions of national law remains 'genuine' for the purpose of asserting earlier marks in opposition proceedings. The sanctions for deceptive use are invalidation or revocation, as the case may be, or a prohibition of use (provided for pursuant to Article 110(2) CTMR).

The same principle applies where use is made under an illegal licensing arrangement (for example arrangements violating the competition rules of the Treaty or national rules). Similarly, the fact that use may infringe third-party rights is also irrelevant.

2.11 Justification of non-use

According to Article 42(2) CTMR, the opponent may alternatively prove that there are justifiable reasons for non-use of its earlier registered mark. These reasons cover, as mentioned in the second sentence of Article 19(1) of the TRIPS agreement, circumstances arising independently of the will of the owner of the trade mark that constitute an obstacle to the use of the trade mark.

As an exception to the obligation of use, the concept of proper reasons for non-use is to be interpreted rather narrowly.

'Bureaucratic obstacles' as such, which arise **independently of the will** of the trade mark proprietor, are not sufficient, unless they have a **direct relationship** with the mark, so much so that the use of the trade mark depends on successful completion of the administrative action concerned. However, the criterion of a direct relationship does not necessarily imply that use of the trade mark is impossible; it might suffice that use is **unreasonable**. It must be assessed on a case-by-case basis whether a change in the undertaking's strategy to circumvent the obstacle under consideration would make use of the mark unreasonable. Thus, for example, the proprietor of a mark cannot reasonably be required to change its corporate strategy and sell its goods in its competitors' sales outlets (judgment of 14/06/2007, C-246/05, *Le Chef de Cuisine*, EU:C:2007:340, § 52).

2.11.1 Business risks

The concept of proper reasons must be considered to refer to circumstances arising independently of the will of the owner that make use of the mark impossible or unreasonable, rather than to circumstances associated with commercial difficulties it is experiencing (decision of 14/05/0008, R 0855/2007-4, *PAN AM*, § 27; judgment of 09/07/2003, T-162/01, *Giorgio Beverly Hills*, EU:T:2003:199, § 41).

Thus, financial difficulties encountered by a company as a result of an economic recession or due to its own financial problems are not considered to constitute proper reasons for non-use within the meaning of Article 42(2) CTMR, as these kinds of difficulties constitute a natural part of running a business.

2.11.2 Government or Court intervention

Import restrictions or other government requirements are two examples of proper reasons for non-use that are explicitly mentioned in the second sentence of Article 19(1) of the TRIPS agreement.

Import restrictions include a trade embargo affecting the goods protected by the mark.

Other *government requirements* can be a State monopoly, which impedes any kind of use, or a State prohibition of the sale of goods for reasons of health or national defence. Typical cases in this respect are regulatory procedures such as:

- clinical trials and authorisation for new medicines (decision of 18/04/2007, R 0155/2006-1, LEVENIA); or
- the authorisation of a Food Safety Authority, which the owner has to obtain before offering the relevant goods and services on the market.

Earlier sign	Case No
HEMICELL	R 0155/2010-2
The evidence filed by the opponent duly shows that use of the earlier marks for a food additive, namely, 'zootechnical digestibility enhancer (feed enzyme)' was conditional upon prior authorisation, to be issued by the European Food Safety Authority following an application filed before that body. Such a requirement is to be deemed a government requirement in the sense of Article 19(1) of TRIPS.	

With regard to Court proceedings or interim injunctions the following must be differentiated:

On the one hand, the mere threat of litigation or a pending cancellation action against the earlier mark should, in general, not exempt the opponent from the obligation to use its trade mark in the course of trade. It is up to the opponent, being the attacking party in opposition proceedings, to conduct an adequate risk assessment of its chances to prevail in the litigation proceedings and to draw the appropriate conclusions from this evaluation as to whether or not to continue with use of its mark (decision of 18/02/2013, R 1101/2011-2, SMART WATER, § 40).

Earlier sign	Case No
HUGO BOSS	R 0764/2009-4
The national [French cancellation] proceedings brought against the opposing trade mark cannot be acknowledged as a proper reason for non-use (paragraph 19).	
The fact remains that proper reasons for non-use are only those outside the sphere and influence of the trade mark proprietor, for instance national authorisation requirements or import restrictions. These are neutral with regard to the trade mark to be used; they concern not the trade mark but the goods and services that the proprietor wishes to use. Such national authorisation requirements or import restrictions apply to the type or properties of the product to which the trade mark is affixed, and cannot be circumvented by choosing a different trade mark. In the present case, conversely, the trade mark proprietor could have readily manufactured cigarettes in France or imported them into France if it had chosen a different trade mark (paragraph 25).	

Earlier sign	Case No
MANPOWER	R 0997/2009-4
According to Article 9 CTMR and Article 5 of the Trade Marks Directive, the trade marks of third parties	

must not be infringed. The requirement not to infringe trade marks applies to any person using a name in the course of trade, regardless of whether it has itself applied for or been granted trade mark protection for that name. A person refraining from such infringements is acting not for 'proper reasons' but as ordered by law. Hence even refraining from use that would otherwise infringe a right is not a proper reason (decision of the Boards of Appeal of 09/03/2010, R 0764/2009-4, HUGO BOSS/BOSS, § 22) (§ 27).

Nor is use in such instances 'unreasonable'. Persons who, as trade mark proprietors, are threatened with proceedings or an interim injunction if they start using it, must consider the prospects of the action against them succeeding and can either capitulate (not start using the trade mark) or defend themselves against the complaint. In any event they have to accept the decision of the independent courts, which may be in expedited proceedings. Nor, pending a decision at final instance, can they object that they must be protected by the fact that, until that decision becomes final, uncertainty is to be recognised as a proper reason for non-use. In fact, the issue of what should happen in the period between the filing of an action or the application for an interim injunction and the conclusive final decision is again to be left to the courts, in that they take decisions that are not yet final on provisional enforceability. The defendant is not entitled to ignore those decisions and be put in a position as if there were no courts (paragraph 28).

On the other hand, for example, an interim injunction or a restraining court order in insolvency proceedings, imposing a general prohibition of transfers or disposals on the trade mark owner, can be a proper reason for non-use because it obliges the opponent to refrain from using its mark in the course of trade. Use of the mark contrary to such a court order would make the trade mark owner liable to damage claims (decision of 11/12/2007, R 0077/2006-1, Miss Intercontinental, § 51).

2.11.3 Defensive registrations

The GC has clarified that the existence of a national provision recognising what are known as 'defensive' registrations (i.e. of signs not intended to be used in trade on account of their purely defensive function in relation to another sign that is being commercially exploited) cannot constitute a proper reason for non-use of an earlier trade mark invoked as a basis of an opposition (judgment of 23/02/2006, T-194/03, Bainbridge, EU:T:2006:65, § 46).

2.11.4 Force majeure

Further justifiable reasons for non-use are cases of *force majeure* that hinder the normal functioning of the owner's enterprise.

2.11.5 Consequences of justification of non-use

The existence of justified reasons does not mean that non-use during the period concerned is treated as equivalent to actual use, which would result in a new grace period beginning after the end of the period of justified non-use.

Rather, non-use during such period merely stops the five-year period from running. This means that the period of justified non-use is not taken into account in calculating the grace period of five years.

In addition, the length of time during which justified reasons existed may be significant. Reasons for non-use existing during only part of the five-year-period before publication of the CTM application may not always be considered justification for setting the proof-

of-use requirement aside. In this context, the period of time during which these reasons were pertinent and the elapse of time since they no longer applied are of particular importance (decision of 01/07/1999, B 2 255).

3 Procedure

3.1 Admissibility of the request for proof of use

According to Article 42(2) CTMR, use of the earlier mark needs be shown – and only be shown – if the applicant requests proof of use. The institution of proof of use is, therefore, designed in opposition proceedings as a *defence plea of the applicant*.

The Office may neither inform the applicant that he could request proof of use nor invite him to do so. In view of the Office's impartial status in opposition proceedings it is left to the parties to provide the factual basis and to argue and defend their respective positions (see second sentence of Article 76(1) CTMR).

Article 42(2) CTMR is not applicable when the opponent, on its own motion, submits material relating to use of the invoked earlier mark (see paragraph 3.1.2 below for an exception to this rule). As long as the CTM applicant does not request proof of use, the issue of genuine use will not be addressed by the Office *ex officio*. In such cases, in principle, it is even irrelevant that the evidence produced by the opponent might demonstrate only a particular type or manner of use, or use that is limited to only part of the goods or services for which the earlier mark is registered.

The request to submit proof of use is only valid if the earlier mark is under the use requirement at all, i.e. if it had been registered for not less than five years.

3.1.1 Time of request

Pursuant to Rule 22(1) CTMIR, the request for proof of use pursuant to Article 42(2) CTMR will be admissible only if the applicant submits such a request within the period specified by the Office. The request for proof of use must be made within the first time limit for the applicant to reply to the opposition under Rule 20(2) CTMIR.

If the request for proof of use is submitted during the cooling-off period or during the two-month period given to the opponent for filing or amending facts, evidence and arguments, it is forwarded to the opponent without delay.

3.1.2 Earlier mark registered for not less than five years

In accordance with Article 42(2) CTMR, the obligation to provide proof of use requires that the earlier registered mark has, at the date of publication of the CTM application, been registered for not less than five years.

For oppositions filed against international registrations designating the EU, the opponent's mark is under use obligation if at the beginning of the opposition period, namely six months after the date of the first re-publication of the international registration, it has been registered for not less than five years.

3.1.2.1 CTMs

The decisive date for establishing whether a trade mark has been registered for not less than five years at the time of publication of the contested application is, according to Article 15 and Article 42(2) CTMR, the registration date of the earlier CTM. If five years or more have elapsed between the registration date of the earlier CTM and the date of publication of the CTM application (or in the case of a contested IR, six months after the date of the first re-publication of the IR), the applicant (or in the case of a contested IR, the holder) is entitled to request proof of use.

3.1.2.2 National marks

For national marks, it is necessary to determine the date that is equivalent to the registration date for CTMs. In interpreting this term, it should be taken into account that there are national trade mark systems that have an opposition procedure **after** registration.

In view of these differing national proceedings, Article 10(1) of the Directive (which is the equivalent of Article 42 CTMR) refers, as concerns the use requirement for national marks, to the period of *'five years following the date of the completion of the registration procedure'*.

The date of the completion of the registration procedure (Article 10(1) of Directive 2008/95) that serves for calculating the starting point of the five year period for the obligation of use for national and international registrations (Article 42(2) and (3) CTMR) is determined by each Member State according to their own procedural rules (judgment of 14/06/2007, C-246/05, *Le Chef de Cuisine*, EU:C:2007:340, § 26-28).

The owner of a mark is not expected to make genuine use of the mark while examination or opposition proceedings are pending, before the five-year grace period mentioned. This is in harmony with the approach towards earlier CTMs, since the registration date of a CTM, which is mentioned in Article 42(2) CTMR as the decisive date for the beginning of the grace period, is always the date of completion of the registration procedure. Furthermore, this interpretation keeps the use requirement under the CTMR in line with the relevant national laws (decisions of 06/05/2004, R 0463/2003-1, *Wrap House*, § 19; 18/06/2010, R 0236/2008-4, *RENO*).

The completion of the registration procedure occurs after a pre-registration opposition or in some Member States even after completion of a post-registration opposition. The exact relevant dates can be found in the table in the attachment, on page 77.

The Office does not investigate on its own initiative the actual date of completion of the registration proceedings. Without evidence to the contrary, the Office assumes that the registration procedure was completed on the date that is indicated as the registration date in the evidence submitted. The opponent has to rebut this presumption by proving the exact date when the registration procedure was completed.

3.1.2.3 International registrations designating a Member State

Under Article 5(2)(a) and (b) of the Madrid Protocol, the Designated Offices have a period of 12 or 18 months from the date of notification of the designation to issue provisional refusals.

Where the Member State has not been designated in the international application but in a subsequent designation, the 12 or 18 months start from the date the subsequent designation was notified to the Designated Offices.

Member States that use the **12-month deadline** to issue a provisional refusal under the Protocol when acting as a designated party are: Benelux, Croatia, Czech Republic, Germany, Spain, France, Latvia, Hungary, Austria, Portugal, Romania and Slovenia.

Member States that have opted for the **18-month deadline** to issue a provisional refusal under the Protocol when acting as a designated party are: Denmark, Estonia, Ireland, Greece, Lithuania, Finland, Sweden and the United Kingdom.

The applicable deadline (12 or 18 months) for Bulgaria, Italy, Cyprus, Poland and Slovakia when acting as a designated party depends on whether (i) such country was designated or subsequently designated before or after 01/09/2008 and (ii) the Office of origin is bound by both the Agreement and the Protocol (deadline: 12 months) or only the Protocol (deadline: 18 months).

See overview table below:

Designated country ²	Country of origin	Deadline to issue a refusal
<i>Benelux, Czech Republic, Croatia, Germany, Spain, France, Latvia, Hungary, Austria, Portugal, Romania and Slovenia</i> (Contracting EU parties bound by both the Agreement and the Protocol).	<i>All contracting parties</i> [Status 15/04/2015: 95 Member States] ³ (Irrespective of whether they are bound by both the Agreement and the Protocol or the Protocol only).	12 months
<i>Denmark, Estonia, Ireland, Greece, Lithuania, Finland, Sweden, UK</i> (Contracting EU parties bound by the Protocol only).	<i>All contracting parties</i> [Status 15/04/2015: 95 Member States] (Irrespective of whether they are bound by both the Agreement and the Protocol or the Protocol only).	18 months
<i>Bulgaria, Italy, Cyprus, Poland, Slovakia; if designated or subsequently designated before 01/09/2008⁴</i> (Contracting EU parties bound by both the Agreement and the Protocol which have opted for an extended deadline).	<i>All contracting parties</i> [Status 15/04/2015: 95 Member States] (Irrespective of whether they are bound by both the Agreement and the Protocol or the Protocol only).	18 months
<i>Bulgaria, Italy, Cyprus, Poland, Slovakia; if designated or subsequently designated on or after 01/09/2008</i>	<i>Contracting parties bound by both the Agreement and the Protocol</i> [Status 15/04/2015: 54 Member States].	12 months

² Malta is not part of the Madrid System.

³ For the full list of all Member States to the Madrid Agreement and to the Madrid Protocol see: http://www.wipo.int/export/sites/www/treaties/en/documents/pdf/madrid_marks.pdf.

⁴ The date of entry into force of Article 9 *sexies* (1)(b) of the Protocol, which rendered inoperative any declaration under Article 5(2)(b) or (c) of the Protocol (extension of the time limit for notifying a provisional refusal) between Contracting Parties bound by both the Agreement and the Protocol.

(Contracting EU parties bound by both the Agreement and the Protocol which have opted for an extended deadline).	<i>Contracting parties bound by the Protocol only</i> [Status 15/01/2013: 33 Member States].	18 months
---	--	-----------

The Office will, on its own motion, apply the 12-month or 18-month deadline according to the above rules. Deadlines are calculated by adding the relevant periods to the date of notification from which the time limit to notify the refusal starts, indicated by INID code 580 on the ROMARIN extract (i.e. not the date of international registration or subsequent designation) (Rule 18(1)(a)(iii) and Rule 18(2)(a) of the Common Regulations).

Only when it is decisive for determining whether the earlier mark is subject to the proof of use obligation is it for the opponent to claim a date that is later (e.g. when a provisional refusal has been lifted after these dates or if the designated country opted for a period even longer than 18 months for notifying a refusal based on an opposition pursuant to Article 5(2)(c) of the Protocol) and for the applicant or holder to claim a date that is earlier than these dates (e.g. when a Statement of Grant of Protection has been issued before these dates) and to provide the Office with conclusive documentation thereof.

In particular, the Court has confirmed, in relation to an earlier international registration designating Germany, that the date on which an earlier international registration is deemed to have been ‘registered’ has to be established in accordance with the German law giving effect to the earlier right, and not by reference to the date of registration with the International Bureau of WIPO. Under German trade mark law, if protection for an internationally registered trade mark is provisionally refused but subsequently granted, the registration is regarded as having taken place on the date of receipt by the International Bureau of WIPO of the final notification that protection has been granted. Proper application of Article 42(2) and (3) CTMR and of Article 4(1) of the Madrid Agreement cannot lead to a breach of the principle of non-discrimination (order of 16/09/2010, C-559/08 P, Atoz, EU:C:2010:529, § 44, 53-56).

3.1.2.4 International registrations designating the European Union

For international registrations designating the European Union, Article 160 CTMR provides that:

For the purposes of applying Article 15(1), Article 42(2), Article 51(1)(a) and Article 57(2), the date of publication pursuant to Article 152(2) shall take the place of the date of registration for the purpose of establishing the date as from which the mark which is the subject of an international registration designating the EU must be put to genuine use in the Community.

As from that publication the international registration has the same effects as a registered CTM pursuant to Article 151(2) CTMR.

3.1.2.5 Summary of calculation of the grace period

Earlier mark	Calculation of the beginning of the 5-year period (grace period)
CTM	Date of registration.

National mark	By default, date of registration or of completion of registration proceedings if proven by opponent.
IR designating Member States	By default, 12 or 18 months after the date of notification from which the time limit to notify the refusal starts (INID code 580). Can be earlier or later if proven by parties.
IR designating the EU	Date of the second re-publication of the EU designation in part M.3. of the Bulletin.

3.1.3 Request must be explicit, unambiguous and unconditional

The applicant's request is a formal declaration with important procedural consequences.

Therefore, it has to be *explicit and unambiguous*. In general, the request for proof of use must be expressed in positive wording. As use or non-use can be an issue in manifold constellations (for example, to invoke or deny a higher degree of distinctiveness of the earlier mark), mere observations or remarks by the applicant in respect of the (lack of) use of the opponent's mark are not sufficiently explicit and do not constitute a valid request for proof of genuine use (judgment of 16/03/2005, T-112/03, Flexi Air, EU:T:2005:102).

Examples:

Sufficiently explicit and unambiguous request:

- 'I request the opponent to submit proof of use ...';
- 'I invite the Office to set a time limit for the opponent to prove use ...';
- 'Use of the earlier mark is hereby contested ...';
- 'Use of the earlier mark is disputed in accordance with Article 42 CTMR.';
- 'The applicant raises the objection of non-use.' (decision of 05/08/2010, R 1347/2009-1, CONT@XT).

Not sufficiently explicit and unambiguous request:

- 'The opponent has used its mark only for ...';
- 'The opponent has not used its mark for ...';
- 'There is no evidence that the opponent has ever used his mark ...';
- '[T]he opponents' earlier registrations cannot be "validly asserted against the CTM Application...", since "...no information or evidence of use ... has been provided..." (decision of 22/09/2008, B 1 120 973).

An implicit request is accepted as an exception to the above rule, when the opponent spontaneously sends evidence of use before the applicant's first opportunity to file arguments and, in its first reply, the applicant challenges the evidence of use filed by the opponent (judgment of 12/06/2009, T-450/07, Pickwick Colour Group,

EU:T:2009:202). In such a case, there can be no mistake as to the nature of the exchange, and the Office should consider that a request for proof of use has been made and give the opponent a deadline for completing the evidence. In the event that proceedings have been closed and the existence of a request for proof of use is found out only when a decision has been taken, the examiner should re-open the proceedings and give the opponent a deadline for completing the evidence.

In any event, the request has to be *unconditional*. Phrases such as 'if the opponent does not limit its goods/services in Classes 'X' or 'Y', we demand proof of use', 'if the Office does not reject the opposition because of lack of likelihood of confusion, we request proof of use' or 'if considered appropriate by the Office, the opponent is invited to file proof of use of its trade mark' present conditional or auxiliary claims, are not valid requests for proof of use (decision of 26/05/2010, R 1333/2008-4, RFID SOLUTIONS).

3.1.4 Applicant's interest to deal with proof of use first

Under Rule 22(5) CTMIR, the applicant may limit its first observations to requesting proof of use. It must then reply to the opposition in its second observations, namely when it is given the opportunity to reply to the proof of use submitted. It may also do this if only one earlier right is subject to the use requirement, as the applicant should not be obliged to split its observations.

If, however, the request is completely invalid, the Office will close proceedings without granting the applicant a further opportunity to submit observations (see paragraph 3.1.5 below).

3.1.5 Reaction if request is invalid

If the request is invalid on any of the above grounds or if the requirements of Article 42(2) and (3) CTMR are not met, the Office nevertheless forwards the applicant's request to the opponent but advises both parties of the invalidity of the request.

The Office will immediately terminate the proceedings if the request is completely invalid and not accompanied by any observations by the applicant. However, the Office can extend the time limit established in Rule 20(2) CTMIR if such an invalid request was received before expiry of the time limit set for the applicant but was not dealt with by the Office until after expiry thereof. Because refusal of the request for proof of use after expiry of the time limit will disproportionately harm the interests of the applicant, the Office extends the time limit by the number of days that were left when the party submitted its request. This practice is based on the rules of fair administration.

If the request is only invalid as regards part of the earlier rights on which the opposition is based, the Office expressly limits the invitation to the opponent to submit proof of use to the rights that are subject to the use requirement.

3.2 Express invitation by the Office

If the applicant's request for proof of use is valid, the Office gives the opponent two months to submit proof of use or show that there are proper reasons for non-use.

Taking a decision on use in the absence of an explicit invitation by the Office to submit proof of use constitutes a substantive procedural violation, even if the applicant's request is clear, the opponent understands it and submits the requested evidence of use (decisions of 28/02/2011, R 0016/2010-4, COLORPLUS, § 20; 19/09/2000, R 0733/1999-1, Affinité/Affinage).

In cases where the request for proof of use arrives during the cooling-off period and is communicated to the opponent during that period, the deadline for submitting proof of use will coincide with the deadline for providing initial or additional facts, evidence and arguments. The time limit will be extended automatically if the cooling-off period is extended.

If the request reaches the Office before the end of the period for submitting or amending facts, evidence and arguments, and is dealt with in this period, the deadline for submitting such facts, evidence and arguments will be extended to coincide with the deadline of two months for submitting proof of use.

3.3 Reaction from the opponent: providing proof of use

3.3.1 Time limit for providing proof of use

The Office gives the opponent two months to submit proof of use. The opponent may request an extension of the deadline in accordance with Rule 71 CTMIR. The common practice on extensions is applicable to these requests⁵.

Rule 22(2) CTMIR expressly states that the Office will reject the opposition if the opposing party does not provide proof of use before the time limit expires.

Three scenarios are to be differentiated.

- Any evidence that has been submitted by the opponent at any time during the proceedings before the expiry of the time limit for providing proof of use, even before the applicant's request for proof of use, has to be taken automatically into account when assessing proof of use.
- The opponent has not submitted **any or any relevant evidence** within the time limit: the submission of relevant evidence of proof of use for the first time after the expiry of the time limit results in rejection of the opposition **without the Office having any discretionary powers**. In that regard the Court has held that Rule 22(2) CTMIR is an essentially procedural provision and that it is apparent from the wording of that provision that when no proof of use of the mark concerned is submitted within the time limit set by the Office, the opposition must automatically be rejected (judgment of 18/07/2013, C-621/11 P, Fishbone, EU:C:2013:484, § 28-29).
- The opponent has submitted **relevant evidence** within the time limit and presents **additional** evidence after the time limit has expired: in such a case, where the additional evidence merely strengthens and clarifies the prior relevant

⁵ See the Guidelines, Part C, Opposition, Section 1, Procedural Matters, paragraph 6.2.1, Extension of time limits in opposition proceedings.

evidence submitted within the time limit, and provided the opponent does not abuse the time-limits set by knowingly employing delaying tactics or by demonstrating manifest negligence, the Office may take into account the evidence submitted out of time as a result of an **objective, reasonable exercise of the discretion** conferred on it by Article 76(2) CTMR (judgment of 29/09/2011, T-415/09, Fishbone, EU:T:2011:550, § 31; confirmed by judgment of 18/07/2013, C-621/11 P, Fishbone, EU:C:2013:484, § 28, 30). The Court made it clear that, *mutatis mutandis*, the same considerations apply to revocation proceedings (judgment of 26/09/2013, C-610/11 P, Centrotherm, EU:C:2013:912, § 87 applying Rule 40(5) CTMR).

The Office shall duly motivate why it rejects or takes into account ‘additional evidence’ in the decision. General statements, such as ‘the evidence is not relevant’ or ‘the opponent has not justified why the additional evidence has been submitted after the expiry of the time limit’ will not suffice (judgment of 26/09/2013, C-610/11 P, Centrotherm, EU:C:2013:912, § 111).

As regards the exercise of that discretion taking such facts and evidence into account, it is particularly likely to be justified where the Office considers, first, that the material produced late is, on the face of it, likely to be relevant to the outcome of the opposition and, second, that the stage of the proceedings at which that late submission takes place and the circumstances surrounding it do not preclude such matters being taken into account (judgment of 13/03/2007, C-29/05 P, Arcol, EU:C:2007:162, § 44).

3.3.2 Means of evidence

3.3.2.1 Principles

The evidence of use must be provided in a structured manner.

Article 76(1) CTMR provides that ‘...in proceedings relating to relative grounds for refusal of registration, the Office shall be restricted in this examination to the facts, evidence and arguments provided by the parties ...’ The filing of evidence must be sufficiently clear and precise to enable the other party to exercise its right of defence and the Office to perform its examination, without reference to extraneous or supportive information.

Essentially, the Office is prevented from making the case for one or other party and cannot take the place of the opponent, or its counsel, by itself trying to locate and identify among the documents on file the information that it might regard as supporting proof of use. This means that the Office should not seek to improve the presentation of any party’s evidence. Responsibility for putting evidence in order rests with the party. Failure to do so leaves open the possibility that some evidence may not be taken into account.

In terms of format and content of evidence submitted, the Office recommends that the following be taken into account as key aspects of a structured presentation:

1. the corresponding **file number** (CTM, Opposition, Cancellation, and Appeal) should be included at the top of all correspondence;

2. a separate communication for documents with Proof of Use should be provided. Nevertheless, if correspondence includes urgent issues such as a request for limitation, suspension, extension of time, withdrawal, etc. indication of this should also be included on the front page;
3. the total **number of pages** of correspondence should be stated. **Page numbering** of annexes is equally important;
4. the Office strongly recommends that the opponent does **not exceed a maximum of 110 pages** in its correspondence;
5. if the documentation is sent in different packages, an **indication of the number of packages** is recommended,
6. if a large amount of documentation is submitted by fax in different batches, an indication of the total number of pages, number of batches and identification of the pages contained in each batch is recommended;
7. use plain **DIN-A4** sheets in preference to other formats or devices for all the documents submitted **including separators** between annexes or enclosures, as they can also be scanned;
8. physical specimens, containers, packaging, etc. should not be sent. Instead, a picture should be taken of them, which should be printed (if relevant in colour, if not in black and white) and sent as a document;
9. original documents or items sent to the Office should not be stapled, bound or placed in folders;
10. **the second copy** for forwarding to the other party should be **clearly identified**;
11. if the original is submitted to the Office only by fax, **no second fax copy** should be sent;
12. the front page should clearly indicate whether the correspondence submitted contains **colour elements** of relevance to the file;
13. a second set of colour elements should be included for sending to the other party.

These recommendations are also sent to the opponent together with the Office's communication of the applicant's request for proof of use.

According to Rule 22(4) CTMIR, the evidence is to be filed in accordance with Rules 79 and 79a and, in principle, is confined to the submission of supporting documents and items such as packages, labels, price lists, catalogues, invoices, photographs, newspaper advertisements, and statements in writing as referred to in Article 78(1)(f) CTMIR. Rule 22(4) CTMIR also allows market surveys and quotations of the mark in lists and publications of associations of the relevant profession as suitable means of evidence (decisions of 14/03/2011, B 1 582 579; 18/06/2010, B 1 316 134).

Price lists and catalogues are examples of 'material stemming directly from the party itself'. A company's 'annual report and accounts' would also come under that heading.

Rule 22(4) CTMIR is to be read in conjunction with Rule 79a CTMIR. This means that material that cannot be scanned or photocopied (such as CDs, physical items) cannot be taken into account unless submitted in two copies so that it can be forwarded to the other party.

The requirement of proof of use always raises the question of the *probative value* of the submitted material. The evidence must at least have a certain degree of reliability. As a general rule, the Office considers material produced by third parties as being of a higher probative value than material produced by the owner himself or by its representative. Reference by the opponent to internal print-outs or hypothetical surveys or orders is particularly problematic. However, where material must regularly be produced for use by the public and/or authorities according to statutory rules, for instance, company law and/or Stock Exchange Regulations, and where it may be assumed that such material is subject to certain official verification, its probative value is certainly higher than ordinary 'personal' material produced by the opponent (see also under paragraph 3.3.2.3, 'Declarations').

3.3.2.2 References

The opponent may avail itself of findings of national offices and courts in parallel proceedings. Although the Office is not bound by findings of the national offices and courts, such decisions must be taken into account and may influence the Office's decision. It is important for the Office to have the possibility of considering the kind of evidence that led to the relevant decision at national level. The Office takes into account the different procedural and substantive requirements that may exist before the respective national body (decisions of 25/08/2003, R 1132/2000-4, VANETTA, § 16; 18/10/2000, R 0550/1999-3, DUKE, § 23).

The opponent may wish to refer to material filed as proof of use in previous proceedings before the Office (confirmed by the GC in 'ELS' quoted above). The Office accepts such references on condition that the opponent clearly identifies the material referred to and the proceedings in which it was filed. If the reference does not sufficiently identify the relevant material, the Office requires the opponent to clearly specify the material referred to or to file it (decision of 30/11/2010, B 1 080 300). See further details on the conditions for identifying the relevant material in the Guidelines, Part C, Opposition, Section 1, Procedural Matters.

The onus of providing proof of use is on the opponent and not on the Office or the applicant. Therefore, a mere indication of the website where the Office can find further information is insufficient, as this does not provide the Office with sufficient indications about place, nature, time and extent of use (decision of 31/10/2001, B 260 192).

3.3.2.3 Declarations

Whereas the means of evidence listed, such as packages, labels, price lists, catalogues, invoices, photographs and newspaper advertisements, do not present any particular problems, it is necessary to consider in some detail declarations as referred to in Article 78(1)(f) CTMR.

The opposing party is not obliged to submit an affidavit concerning the sales made under the earlier trade mark. It is up to the opposing party to select the form of evidence that it considers suitable for the purpose of establishing that the earlier trade

mark was put to genuine use during the relevant period (judgment of 08/07/2004, T-203/02, Vitafruit, EU:T:2004:225, § 37).

The role of the affidavit is to inform about facts or give explanation of the supporting documents, not to give a legal opinion (judgment of 06/11/2014, T-463/12, MB, EU:T:2014:935, § 56).

Distinction between admissibility and relevance (probative value)

The importance of declarations has been much debated. In this regard, there must be a clear differentiation between the admissibility and the probative value of such evidence.

As far as *admissibility* is concerned, Rule 22(4) CTMIR expressly mentions written statements referred to in Article 78(1)(f) CTMR as admissible means of proof of use. Article 78(1)(f) CTMR cites means of giving evidence, amongst which are sworn or affirmed written statements or other statements that have a similar effect according to the law of the State in which they have been drawn up. Therefore, it has to be evaluated whether the statement submitted constitutes a statement within the sense of Article 78(1)(f) CTMR. Only in cases where the statements have not been sworn or affirmed it is necessary to consider the rules of law of the national jurisdiction as to the effects of a written statement (judgment of 07/06/2005, T-303/03, Salvita, EU:T:2005:200, § 40, recently confirmed in judgment of 09/12/2014, T-278/12, PROFLEX, EU:T:2014:1045, § 49). In cases of doubt as to whether a statement has been sworn or affirmed, it is up to the opponent to submit evidence in this regard. Failing this the statement will not be considered a statement within the sense of Article 78(1)(f) CTMR.

Article 78(1)(f) CTMR does not specify by whom these statements should be signed so that there is no reason to consider that statements signed by the parties to the proceedings themselves are not covered by this provision (judgment of 16/12/2008, T-86/07, Deitech, EU:T:2008:577, § 46).

Neither the CTMR nor the CTMIR supports the conclusion that the evidential value of items of evidence of use of the mark, including affirmations, must be assessed in the light of the national law of a Member State (judgments of 28/03/2012, T-214/08, Outburst, EU:T:2012:161, § 33; 09/12/2014, T-278/12 PROFLEX, EU:T:2014:1045, § 53). The probative value of a statement depends first and foremost on the credibility of the account it contains. It is then necessary to take account, in particular, of the person from whom the document originates, the circumstances in which it came into being, the person to whom it was addressed and whether, on the face of it, the document appears sound and reliable (judgment of 07/06/2005, T-303/03, Salvita, EU:T:2005:200, § 42).

As far as the *probative value* of this kind of evidence is concerned, the Office makes a distinction between statements coming from the sphere of the opponent themselves or their employees and statements drawn up by an independent source; following the established case-law (judgments of 09/12/2014, T-278/12, PROFLEX, EU:T:2014:1045, § 51; 06/11/2014, T-463/1, MB, EU:T:2014:935, § 54).

Declarations by the proprietor or its employees

Statements coming from the sphere of the owner of the earlier mark (drawn up by the interested parties themselves or their employees) are generally given less weight than independent evidence. This is because the perception of the party involved in the dispute may be more or less affected by personal interests in the matter (decision of 11/01/2011, R 0490/2010-4, BOTODERM, § 34; decisions of 27/10/2009, B 1 086 240 and of 31/08/2010, B 1 568 610).

Such a statement cannot in itself sufficiently prove genuine use (judgment of 9/12/2014, T-278/12, PROFLEX, EU:T:2014:1045, § 54) However, this does not mean that such statements are totally devoid of all probative value (judgment of 28/03/2012, T-214/08, Outburst, EU:T:2012:161, § 30). Generalisation should be avoided, since the exact value of such statements always depends on its concrete form and content. Statements including detailed and concrete information have a higher probative value than very general and abstractly drafted statements.

The final outcome depends on the overall assessment of the evidence in each individual case. In general, further material is necessary for establishing evidence of use, since such statements have to be considered as having less probative value than physical evidence (labels, packaging, etc.) or evidence originating from independent sources. Therefore, the probative strength of the further material submitted is very important. An assessment should be made of whether the content of the affidavit is sufficiently supported by the further material (or vice versa). The fact that the national office concerned may adopt a certain practice in assessing such kind of evidence of use does not mean that it is applicable in the proceedings concerning Community trade marks (judgment of 07/06/2005, T-303/03, Salvita, EU:T:2005:200, § 41 *et seq.*).

A change of ownership that took place after the date of publication of the CTM application may render declarations made by the new owners void as the latter generally do not have any direct knowledge as a basis for making declarations concerning use of the mark by the previous owner (decision of 17/06/2004, R 0016/2004-1, Reporter).

Nevertheless, in the case of a transfer or other succession in title, any new owner may rely on use within the grace period concerned by their predecessor(s). Use made by the predecessor may be evidenced by the predecessor and by all other reliable means, for instance, information from business records if the predecessor is not available.

Declarations by third parties

Statements (such as e.g. surveys) drawn up *by an independent source*, for example by experts, professional organisations, Chambers of Commerce, suppliers, customers or business partners of the opponent, are given more probative weight (decisions of 19/01/2011, R 1595/2008-2, FINCONSUMO, § 9(ii); 30/03/2010, R 0665/2009-1, EUROCERT, § 11 and decision of 12/08/2010, B 1 575 615).

This practice is in line with the case-law of the Court of Justice in the ‘Chiemsee’ judgment (judgment of 04/05/1999, joined cases C-108/97 and C-109/97, Chiemsee, EU:C:1999:230), where the Court gave some indications of appropriate evidence proving the acquired distinctiveness of a mark in the market place. Although acquisition of distinctiveness is not per se the same as genuine use, the former does comprise elements of evidence of use of a sign on the market. Consequently, case-law relating to these can be used by analogy.

Statements drawn up by the parties themselves are not 'third party evidence' whereas all other evidence, such as opinion polls, statements from Chambers of Commerce, or from professional organisations or from experts, originates from third parties.

3.4 Reaction from the applicant

3.4.1 Forwarding of evidence

After having received the evidence of use submitted by the opponent, the Office forwards the complete evidence to the applicant.

The Office, in general, allows the applicant two months to file its observations in reply to the evidence of use (and to the opposition).

3.4.2 No evidence or no relevant evidence submitted

However, the Office may close the proceedings immediately if the opponent has submitted **no evidence, or the evidence is manifestly of no relevance** within the time limit given and all the earlier rights of the opposition are affected. The rationale behind this practice is to avoid the continuation of the proceedings when their outcome is already known, that is, the rejection of the opposition for lack of proof of use (principle of economy and good administration of proceedings).

In all other cases it is forwarded to the applicant giving the party two months to file its observations. The Office must not indicate to the opponent that the sufficiency of the evidence is doubtful, or even invite the opponent to file further evidence in such cases. Such acts would be against the impartial position of the Office in adversarial proceedings (decision of 01/08/2007, R 0201/2006-4, OCB/O.C.B., § 19).

3.4.3 No reaction from applicant

If the applicant does not react within this time limit, the Office will give a decision on the basis of the evidence before it. The fact that the applicant does not reply does not mean that it accepts the submitted evidence as sufficient proof of use (judgment of 07/06/2005, T-303/03, *Salvita*, EU:T:2005:200, § 79).

3.4.4 Formal withdrawal of the request

Where the applicant reacts to the proof of use by formally withdrawing its request for proof of use, the issue will no longer be relevant. As it is the applicant who sets in motion the respective procedure, the applicant logically is in a position to bring an end to this part of the proceedings by formally withdrawing its request (decision of 21/04/2004, R 0174/2003-2, *Sonnengarten*, § 23).

3.5 Further reaction from the opponent

The opponent is entitled to file observations in reply to the applicant's observations. This is of particular importance in cases where the decision to be taken might be based in part on the arguments put forward by the applicant to the effect that the evidence does not prove the use of the mark.

The Board of Appeal has regarded failure to allow the opponent to comment in such a case as a substantial procedural violation (decision of 28/02/2011, R 16/2010-4, COLORPLUS, § 20).

For further details on the submission of additional evidence, see paragraph 3.3.1 above.

3.6 Languages in proof of use proceedings

According to Rule 22(6) CTMIR, where the evidence supplied pursuant to paragraphs 1, 2 and 3 is not in the language of the opposition proceedings, the Office *may* require the opponent to submit a translation of that evidence in that language, within a period specified by the Office.

It is left to the discretion of the Office whether the opponent has to submit a translation of the evidence of use into the language of the proceedings. In exercising its discretion, the Office balances the interests of both parties.

It has to be borne in mind that it might be extremely costly and burdensome for the opponent to translate the evidence of use submitted into the language of the proceedings.

On the other hand, the applicant has the right to be informed about the content of the evidence filed in order to be capable of defending its interests. It is absolutely necessary that the applicant is able to assess the content of the evidence of use submitted by the opponent. In this regard, the nature of the documents submitted has to be taken into account. For example, it might be considered that 'standard' invoices and samples of packaging do not require a translation in order to be understood by the applicant (judgment of 15/12/2010, T-132/09, Epcos, EU:T:2010:518, § 51 *et seq.*; decisions of 30/04/2008, R 1630/2006-2, DIACOR, § 46 *et seq.* (under appeal T-258/08); 15/09/2008, R 1404/2007-2, FAY, § 26 *et seq.*).

If the applicant explicitly requests a translation of the evidence in the language of the proceedings, the Office, in principle, will require a translation from the opponent. However, a rejection of such a request is feasible where it appears that the applicant's request, in view of the self-explanatory character of the submitted evidence, is exaggerated or even abusive.

Where the Office requires translation of the evidence, it gives the opponent a period of two months to submit it. Where the evidence of use filed by the opponent is voluminous, the Office may explicitly invite the opponent to translate only the parts of the submitted material that the opponent regards as sufficient for establishing genuine use of the mark within the relevant period. It is in general up to the opponent to evaluate whether a complete translation of all the evidence submitted is necessary. The means of evidence will only be taken into account insofar as a translation has

been produced or insofar as the means of evidence are self-explanatory regardless of their textual components.

3.7 Decision

3.7.1 Competence of the Office

The Office makes its own evaluation of the evidence of use submitted. This means that the probative value of the evidence submitted is evaluated independently of the observations submitted by the applicant in this respect. Assessment of the relevance, pertinence, conclusiveness and efficacy of evidence lies within the discretion and power of judgment of the Office, not the parties, and falls outside the adversarial principle which governs *inter partes* proceedings (decisions of 01/08/2007, R 0201/2006-4, OCB, § 19; 14/11/2000, R 0823/1999-3, SIDOL).

A declaration by the applicant concluding that use has been proved does not, therefore, have any effect on the Office's findings. The request for proof of use is a defence plea by the applicant. However, once the defence plea has been raised by the applicant, it is solely up to the Office to carry out the subsequent procedure and evaluate whether the evidence submitted by the opponent is to be regarded as of sufficient probative value. However, the applicant does have the possibility of formally withdrawing the request for proof of use (see paragraph 3.4.4 above).

This is not contrary to Article 76(1) CTMR, which stipulates that in *inter partes* proceedings the Office is restricted in its examination to the facts, evidence and arguments provided by the parties and the relief sought. However, although the Office is bound by the facts, evidence and arguments provided by the parties, it is not bound by the legal value that the parties may give thereto. Hence, the parties may agree as to which facts have been proved or not, but may not determine whether or not these facts are sufficient to establish genuine use (decisions of 01/08/2007, R 0201/2006-4, OCB, § 19; 14/11/2000, R 0823/1999-3, SIDOL, § 20; 13/03/2001, R 0068/2000-2, NOVEX PHARMA).

3.7.2 Need for assessing proof of use

A decision on fulfilment of the obligation of having genuinely used the registered mark is not always necessary.

When **proof of use** of the earlier rights has been requested by the applicant, the Office will also examine whether, and to what extent, use has been proved for the earlier marks, provided this is relevant for the outcome of the decision in question. The examination of proof of use is always necessary and obligatory in the cases where the opposition is fully or partially successful on the basis of the earlier mark that was subject to the proof of use obligation.

The Office may decide not to assess the submitted proof of use where the question whether the earlier mark concerned was genuinely used for the respective registered goods and/or services is irrelevant for the outcome of the opposition, for example:

- under the ground of Article 8(1)(b) CTMR, if there is no likelihood of confusion between the contested mark and the earlier mark that is subject to the proof of use obligation;
- if the opposition is fully successful on the basis of another earlier mark which is not subject to the proof of use obligation;
- if the opposition is fully successful on the grounds of Article 8(3) and/or Article 8(4) CTMR;
- under the ground of Article 8(5) CTMR, if one of the necessary conditions for application of this ground is not fulfilled.

However, in case the earlier trade mark that was subject to the proof of use obligation was examined in the decision but the assessment of the proof of use has been omitted, this shall be expressly stated in the decision with a brief justification.

3.7.3 Overall assessment of the evidence presented

As stated in more detail above (see paragraph 2.2 above), the Office has to evaluate the evidence submitted with regard to place, time, extent and nature of use in an *overall assessment*. A separate assessment of the various relevant factors, each considered in isolation, is not suitable (judgment of 17/02/2011, T-324/09, Friboi, EU:T:2011:47, § 31).

The *principle of interdependence* applies, meaning that weak evidence with regard to one relevant factor (e.g. low sales volume) might be compensated by solid evidence with regard to another factor (e.g. continuous use over a long period of time).

All the circumstances of the specific case have to be taken into account *in conjunction with each other* in order to determine whether the mark in question has been genuinely used. The particular circumstances can include, for example, the specific features of the goods/services in question (e.g. low/high-priced; mass products v special products) or the particular market or business area.

Indirect/circumstantial evidence, under certain conditions even on its own, can also be suitable for proving genuine use.

As the Office does not assess commercial success, even minimal use (but not mere token or internal use) can be sufficient to be deemed 'genuine', as long as it is viewed as warranted in the economic sector concerned to maintain or acquire a share in the market.

The decision indicates what evidence was filed. However, in general, only the evidence relevant for the conclusion is mentioned. If the evidence is found convincing, it suffices for the Office to indicate those documents that were used to come to this conclusion and why. If an opposition is rejected because the proof of use was not sufficient, likelihood of confusion is not to be addressed, nor Article 8(5) CTMR if claimed.

3.7.4 Examples

The following cases present some of the decisions of the Office or the Court (with different outcomes) where the overall assessment of the submitted evidence was important:

3.7.4.1 Genuine use accepted

Case No	Comment
Judgment of 17/02/2011, T-324/09, Friboi, EU:T:2011:47	The opponent (Fribo Foods Ltd.) submitted several invoices relating to large quantities of goods, addressed to its distribution company (Plusfood Ltd.), which belongs to the same group (Plusfood Group). It is not disputed that the distribution company put the products on the market later. Furthermore, the opponent presented undated brochures , a press clip and three price lists . With regard to the 'internal' invoices, the Court held that the chain producer-distributor-market was a common method of business organisation, which could not be regarded as purely internal use. The undated brochures had to be seen in conjunction with other dated evidence such as invoices and price lists and, therefore, might still be taken into consideration. The Court accepted genuine use and stressed that an overall assessment implied that all the relevant factors be viewed as a whole and not in isolation.
Decision of 02/05/2011, R 0872/2010-4, CERASIL	The opponent submitted inter alia about 50 invoices , not in the language of proceedings. The names of the addressees as well as the quantities sold were blacked out. The Boards held that standard invoices containing the usual information (date, indication of seller's and buyer's name/address, product concerned, price paid) did not require a translation. Even though the names of the addressees and the quantities sold were blacked out, the invoices nevertheless confirmed the sale of 'CERATOSIL' products, measured in kilograms, to companies throughout the relevant territory during the relevant period. Together with the remaining evidence (brochures, affidavit, articles, photographs), this was considered sufficient to prove genuine use.
Decision of 29/11/2010, B 1 477 670	The opponent, who was active in the field of vehicle maintenance and the management of businesses associated with buying and selling vehicles, provided several Annual Reports giving a general overview of its overall commercial and financial activities. The OD found that these reports, by themselves, did not provide sufficient information on actual use for the majority of services claimed. However, in conjunction with advertisements and publicity displaying the mark in question for particular services, the OD concluded that the evidence as a whole provided sufficient indications as to the scope, nature, period and place of use for these services.
Decision of 29/11/2010, R 0919/2009-4, GELITE	The documents submitted by the appellant show use of the trade mark in relation to 'coating materials based on artificial resin (base, intermediate and top coatings) and industrial lacquers'. The attached labels show use of the trade mark for various base, primer and top coatings. This information coincides with the attached price lists . The associated technical information sheets describe these goods as corrosion coatings based on artificial resin, which are offered for sale in various colours. The attached invoices show that these goods were supplied to various customers in Germany. Although the turnover figures stated in the written declaration in relation to the period from 2002 to 2007 do not expressly refer to Germany, it must be concluded that they were obtained at least in part also in Germany. Consequently, the earlier mark is deemed to be used for the goods 'lacquer, lacquer paints, varnishes, paints; dispersions and emulsions to coat and repair surfaces' because it is not possible to create any further subcategories for these goods.
Decision of 20/04/2010, R 0878/2009-2, SOLEA	The solemn declaration refers to high sales figures (over EUR 100 million) for marked products from 2004 to 2006 and attaches internet extracts of pictures of the products sold during the relevant period (soap, shampoo, deodorant (for feet and body), lotions, and cleaning items). Although the internet extracts bear a copyright date of 2008, the credibility of what the declaration affirms is reinforced

	by the judgment of the State Court of Mannheim, a copy of which had been adduced previously by the opponent in order to demonstrate the enhanced distinctiveness of the earlier mark and which referred to the market share enjoyed by products bearing the opponent's mark for ladies' face care products (6.2 %), caring lotions (6.3 %), shower soaps and shampoos (6.1 %) and men's face care and shaving products (7.9 %). Moreover, the judgment states that according to a GfK study one fifth of German citizens purchase at least one BALEA product per annum. Reference is also made to two further studies that demonstrate that the brand is well known in Germany. Thus, proof of use for the mark has been demonstrated sufficiently for the products on which the opposition is based.
Decision of 25/03/2010, R 1752/2008-1, ULUDAG	The evidence provided to substantiate use of the earlier Danish trade mark appears to be sufficient. The Board is satisfied that the invoice provided shows place and time of use, as it proves the sale to a Danish company of 2 200 cartons of products within the relevant date. The labels filed show use on soft drinks bearing the mark as represented on the registration certificate. As to the question whether proof consisting of one single invoice is sufficient in terms of extent of use, in the Board's view, the content of that invoice, in the context of the remaining pieces of evidence, serves to conclude that the use made of the mark in Denmark is sufficient and genuine in connection with 'aerated water, aerated water with fruit taste and soda water'.

3.7.4.2 Genuine use not accepted

Case No	Comment
Judgment of 18/01/2011, T-382/08, VOGUE, EU:T:2011:9	The opponent submitted a declaration from the opponent's managing partner and 15 footwear manufacturers ('footwear has been produced for the opponent under the trade mark VOGUE over a number of X years'), 35 photographs of VOGUE footwear models, photographs of stores and 670 invoices issued to the opponent by footwear manufacturers. The Court held that the declarations did not provide sufficient evidence concerning the extent, place and time of use. The invoices concerned the sale of footwear <u>to</u> the opponent, not the sale of footwear to end consumers and, therefore, were not suitable for proving external use. Mere presumptions and suppositions ('highly unlikely', 'unreasonable to think', '... which probably explains the absence of invoices ...', 'reasonable to assume', etc.) cannot replace solid evidence. Therefore, genuine use was denied.
Decision of 19/09/2007, 1359 C (confirmed by R 1764/2007-4)	The owner of the mark owned a US-based airline, operating solely in the US. The fact that flights could also be booked via internet from the European Union could not alter the fact that the actual services of transportation (Class 39) were rendered exclusively outside the relevant territory. Furthermore, the lists submitted of passengers with addresses in the European Union could not prove that the flights had actually been booked from Europe. Finally, the website was exclusively written in English, the prices were announced in US dollars and the relevant telephone and fax numbers were from within the US. Therefore, genuine use in the relevant territory was denied.
Decision of 04/05/2010, R 0966/2009-2, COAST	There are no special circumstances which might justify a finding that the catalogues submitted by the opponent, on their own or in combination with the website and magazine extracts , prove the extent of use of any of the earlier signs for any of the G&S involved. Although the evidence submitted shows use of the earlier sign in connection with ' <i>clothing for men and women</i> ', the opponent did not produce any evidence whatsoever indicating the commercial volume of the exploitation of this sign to show that such use was genuine.
Decision of 08/06/2010, R 1076/2009-2, EURO CERT	It is well established in the case-law that a declaration , even if sworn or affirmed in accordance with the law under which it is rendered, must be corroborated by independent evidence. The declaration in this case, drawn up by an employee of the opponent's company, contains an outline of the nature of the relevant services, but only general statements concerning trade activities. It contains no detailed sales or advertising figures or other data that might show the extent and

	<p>use of the mark. Furthermore, a mere three invoices with important financial data blanked out and a list of clients can hardly be considered corroborative evidence. Therefore, no genuine use of the earlier mark has been demonstrated.</p>
<p>Decision of 01/09/2010, R 1525/2009-4, OFFICEMATE</p>	<p>The spreadsheets with turnover figures and the Analysis and Review reports concerning sales figures are documents drawn up by or commissioned by the appellant itself and, therefore, have less probative value. None of the evidence filed contains any clear indication concerning the place of use of the earlier mark. The spreadsheets and the Analysis and Review Reports, which contain data compiled on the total value of estimated sales (in SEK) between the years 2003 to 2007, contain no information on where the sales took place. There is no reference to the territory of the European Union, where the earlier trade mark is registered. The invoices do not cover any sales of goods made by the appellant. Therefore, the evidence submitted is clearly insufficient to prove the genuine use of the earlier mark.</p>
<p>Judgment of 12/12/2002, T-39/01, HIWATT, EU:T:2002:316</p>	<p>A catalogue showing the mark on three different models of amplifiers (but not indicating place, time or extent), a catalogue of the Frankfurt International trade fair showing that a company called HIWATT Amplification International exhibited at that fair (but not indicating any use of the trade mark) and a copy of the 1997 HIWATT Amplification Catalogue showing the mark on different models of amplifiers (but not indicating place or extent of use) were not considered sufficient to prove genuine use, principally because of lack of extent of use.</p>

Annex

Five-year period for assessing use of national trade marks

According to Article 42 (2) CTMR the proprietor of an earlier CTM who has given notice of opposition against the registration of a CTM application shall, where the CTM applicant so requests, submit proof that his earlier CTM has been put to genuine use in the Community in connection with the goods or services for which it was registered during the period of five years preceding the date of publication of the CTM application, provided the earlier CTM has at that date been registered for more than five years ('5-year grace period').

Equally, the proprietor of an earlier national mark who has given notice of opposition against the registration of a Community trade mark shall, according to Article 42(3) CTMR and where the CTM applicant so requests, submit proof that his earlier national trade mark has been put to genuine use in the Member State in connection with the goods and services for which it was registered during a period of five years preceding the date of publication of the CTM application, provided the earlier national mark has at that date been registered for more than five years.

The date of registration of a CTM is the date in which it is entered in the Register of Community trade marks. Consequently, the 5-year grace period of a CTM commences from its entry in the Register of Community trade marks.

In order to determine the date of commencement of the 5-year grace period in respect of a national mark, national law is relevant. The commencement of this period depends on the registration procedure of the Member States and, in particular, whether a Member State applies a post registration opposition procedure (this being the case in respect of DE, DK, FI and SE).

The following table makes reference to the relevant national provisions⁶ on non-use of a national trade mark and specifies the relevant point in time when the five-year grace period for a national trade mark commences.

Member State	Relevant legal provisions	Quotation of the relevant legal provisions	Summary / Comments
Austria	Article 33a(1), AT-TML	<i>'registered for a minimum of five years where it has not been used ... in Austria during the five years preceding submission of the request.'</i>	Date of entry in the Register of trade marks.
Benelux	Article 2.26(2)(a) BCIP	<i>'insofar as no normal use has been made of the mark on the Benelux territory for the goods for which the mark is registered, without valid reason, during an uninterrupted period of five</i>	Date of registration of the trade mark.

⁶ The references are made to the national provisions as valid on 1 June 2015.

Member State	Relevant legal provisions	Quotation of the relevant legal provisions	Summary / Comments
		years.'	
Bulgaria	Article 19(1), BG-TML	'...within a period of five years following registration...'	Date of registration of the trade mark.
Croatia	Article 29(2) HR-TMA	'... the earlier trade mark has, on the date of publication of the application for the registration of the trade mark, been registered for not less than five years.'	Date of registration of the trade mark.
Cyprus	Section 28A, CY-TML	'If, within a period of five years from the date of entry of the mark in the Register of trade marks, the proprietor has not put the mark to genuine use in connection with the goods and services [...] in respect of which it is registered...'	Date of entry of the mark in the Register of Trade Marks.
Czech Republic	Section 13(1), CZ-TML	'...five years following the registration, the proprietor of the trade mark has not put the trade mark to genuine use...'	Date of entry of the mark in the Register of Trade Marks. Comment: please note that the relevant date of entry in the Register is shown on the extracts from the official database of the CZ Office under INID code 151 (registration date).
Denmark	Paragraph 25(1), DK-TML	'... Within a period of five years following the date of the termination of the registration procedure [when]the proprietor [...] has not put the trade mark to genuine use [...], or if such use has been suspended during an uninterrupted period of five years [...] unless there are proper reasons for non-use.'	<u>Where no opposition has been lodged:</u> 2 months after the publication of the registration (post-registration opposition procedure). <u>Where an opposition has been lodged:</u> a. date where the decision on the opposition becomes final (i.e. in cases of final refusal of the opposition, namely where time limit for appeal has expired or where possibilities for appeal have been exhausted); or b. date of withdrawal of the opposition.
Estonia	Paragraph 53(1)(3), (4), paragraph 53(2) and (3), EST-TML	'...during five consecutive years after the making of the registration, without good reason...'	Date of entry of the mark in the Register of Trade Marks.
Finland	Section 26, FI-TML Section 20 FI-FML	'... if the trade mark has not been used for the last five years ...' '... the registering authority shall enter the trade mark in the register and give public notice thereof. Any opposition to the registration of the trade mark shall be filed in writing with the registering authority within two	<u>Where no opposition has been lodged:</u> date of registration (post registration opposition procedure). <u>Where opposition has been lodged:</u> date of closure of the

Member State	Relevant legal provisions	Quotation of the relevant legal provisions	Summary / Comments
		<i>months of the date of the public notice.'</i>	opposition proceedings (i.e. final refusal of the opposition or disposal, otherwise, e.g. by withdrawal of the opposition).
France	Article L. 714-5, FR-IP CODE	<i>'... use during an uninterrupted period of five years.'</i>	Date of publication of the registration in the 'Bulletin officiel de la propriété industrielle'.
Germany	Section 26(5), DE-TML	<i>'Insofar as use within five years from the point in time of the registration is necessary, in cases in which an opposition has been lodged against the registration, the time of the registration shall be substituted by the point in time of the conclusion of the opposition proceedings.'</i>	<u>Where no opposition has been lodged:</u> date of registration (post registration opposition procedure). <u>Where opposition has been lodged:</u> date of closure of the opposition proceedings (i.e. final refusal of the opposition or disposal, otherwise, e.g. by withdrawal of the opposition).
Greece	Article 147(2) read jointly with Article 143(1), GR-TML Article 160(1)(a) GR-TML	<i>'Once the decision accepting the TM is final, the filing date constitutes the registration date.'</i> <i>'The mark is revoked if it is not used within five years from the registration...'</i>	Date of filing the application.
Hungary	Article 18(1), HU-TML Article 64(1), HU-TML	<i>'...within a period of five years following the date of registration...'</i> <i>'[...] The date of the decision on registration shall be the date of registration of the trade mark.'</i>	Date of registration of the mark.
Ireland	Article 51(1)(a), (b), IE-TMA	<i>'... within the period of five years following the date of publication of the registration.'</i>	Date of publication of the registration of the mark.
Italy	Article 24(1), IT- IP CODE	<i>'within five years from registration.'</i>	Date of issuing of the registration certificate.
Latvia	Article 23(3) LV-TML	<i>'...within five years from the date of registration...and there are not sufficient reasons for non-use.'</i>	Date of entry of the mark in the Register of trade marks.
Lithuania	Article 47(2), LT-TML	<i>'The registration of a mark may be revoked if, within a period of five years <u>after the issue of the registration certificate</u>, a genuine use of the mark has not been started by the proprietor of the mark in the Republic of Lithuania or the proprietor has not expressed serious intention to use the mark in respect of the goods and/or services for which it</i>	Date of issuing of the registration certificate.

Member State	Relevant legal provisions	Quotation of the relevant legal provisions	Summary / Comments
		<i>is registered, or if the mark has not been put to genuine use for a period of five continuous years, except in cases where the use of the mark was prevented by serious reasons.'</i>	
Malta	Article 42(1)(a), MT-TMA	<i>'...within the period of five years following the date of completion of the registration procedure it has not been put to genuine use...'</i>	
Poland	Article 169(1)(i), PL-IPL	<i>'The right of protection for a trade mark shall also lapse on failure to put to genuine use of the registered trade mark for the goods covered by the registration for a period of five successive years after a decision on the grant of a right of protection has been taken, unless serious reasons of non-use thereof exist ...'</i>	Date of the registration. Comment: the Polish examination includes also examination of relative grounds <i>ex officio</i> and the decision on the grant of a right of protection is issued after a complete examination has taken place.
Portugal	Article 269(i), PT-IP Code Article 269(5), PT-IP Code.	<i>'... the registration shall lapse if the trade mark is not put to serious use over a period of five consecutive years.'</i> <i>The five years period starts running as from the date of registration.</i>	Date of registration.
Romania	Article 46(1)(a), RO – TML	<i>'...during five consecutive years, following the date of entry (i.e. of the mark) in the Trade marks Register, the mark was not put to genuine use in Romania for the goods or services for which it was registered'</i>	Date of entry of the mark in the Trade marks Register. Comment: the Romanian TM Law does not explicitly define 'the date of entry in the Register' or 'the registration date' of the mark, terms which are used interchangeably in the Law. In any case, please note that the relevant date is shown on the extracts from the official database of the RO Office under INID code 151 (registration date).
Slovakia	Section 34(1), SK-TML	<i>'...if the trade mark was not put in genuine use in Slovakia for the goods and services for which it has been registered for a continuous period of five years ...'</i>	Date of entry of the mark in the Register of trade marks.
Slovenia	Article 120(1), SL-IP ACT	<i>'...within a continuous period of five years from the date of entry of the right in the register.'</i>	Date of entry of the mark in the Register of trade marks.
Spain	Article 39 ES-TML	<i>'five years following the publication, the proprietor of the trade mark has not put the trade mark to genuine use in Spain for the registered goods and</i>	Date of publication of the registration.

Member State	Relevant legal provisions	Quotation of the relevant legal provisions	Summary / Comments
		<i>services or if within a continuous period of five years the trade mark has not been put to genuine use.'</i>	
Sweden	Chapter 3, paragraph 2 SE-TML	<i>'Within a period of five years following the date of the completion of the registration Procedure.'</i>	Where no opposition has been lodged: 3 months after the publication of the registration (post registration opposition procedure). Where an opposition has been lodged: on the date where the decision on the opposition becomes final.
United Kingdom	Section 46(1)(a), (b), UK-TML	<i>'... within a period of five years following the date of completion of the registration procedure ...'</i>	Date of entry of the mark in the Register of Trade marks.

***GUIDELINES FOR EXAMINATION IN THE
OFFICE FOR HARMONIZATION IN THE
INTERNAL MARKET (TRADE MARKS AND
DESIGNS) ON COMMUNITY TRADE MARKS***

PART D

CANCELLATION

SECTION 1

PROCEEDINGS

Table of Contents

1	Introduction: General Outline of Cancellation Proceedings	3
2	Application for Cancellation	4
2.1	Persons entitled to file an application for cancellation	4
2.2	Written applications	4
3	Payment of the Fee	5
4	Admissibility Check	5
4.1	Relative admissibility requirements (Rule 37 CTMIR)	7
4.1.1	Registration number of the contested CTM and name and address of its owner (Rule 37(a)(i) and (ii) CTMIR)	7
4.1.2	Extent of the application for cancellation (Rule 37(a)(iii) CTMIR)	7
4.1.3	Grounds of the application for cancellation and facts, evidence and arguments presented in support of those grounds (Rule 37(b) CTMIR)	8
4.1.4	Identification of the applicant (Rule 37(c) CTMIR)	9
4.2	Invitation to remedy deficiencies	10
5	Notification of the Application to the CTM Proprietor and Further Exchanges between the Parties	11
6	Languages Used in Cancellation Proceedings	12
6.1	Translation of the application for cancellation	13
6.2	Translation of the evidence submitted by the applicant in support of the application	13
6.3	Translation of observations submitted by the parties in the course of the proceedings	14
6.4	Translation of evidence submitted by the CTM proprietor in the course of the proceedings	14
6.5	Translation of proof of use	15
7	Other Issues	16
7.1	Continuation of proceedings	16
7.2	Suspensions	16
7.3	Surrenders and withdrawals	17
7.3.1	Surrenders covering all the contested goods and/or services	17
7.3.2	Surrenders covering only a part of the contested goods and/or services	18
7.3.3	Withdrawals	18
7.4	Applications for revocation and for invalidity against the same CTM	18
7.5	Contested international registrations designating the EU	19

1 Introduction: General Outline of Cancellation Proceedings

Proceedings in the Office concerning the revocation or invalidity of a registered Community trade mark (CTM) are grouped under the general heading of 'cancellation proceedings' and are managed in the first instance by the Cancellation Division. The basic rules regarding these proceedings are mainly contained in Articles 56 and 57 CTMR and in Rules 37 to 41 CTMIR.

Cancellation proceedings are initiated with the submission of an application for revocation or for a declaration of invalidity (the 'application for cancellation') against a registered CTM. An application for cancellation against a CTMA that has not yet been registered is not admissible.

Once the application for cancellation is received, the Office checks that the corresponding cancellation fee has been paid. If the fee has not been paid, the application is deemed not to have been filed. Next, the Office carries out a preliminary assessment of the admissibility requirements, which includes, in particular, those stated under Rule 37 CTMIR. The Office also notifies the CTM proprietor of the application. If there are any deficiencies related to relative admissibility requirements, the Office will ask the cancellation applicant (the applicant) to remedy them within a specified time limit.

Once the admissibility check has been completed, the Office will make an entry in the Register of the pending cancellation proceedings for the contested CTM (Rule 84(3)(n) CTMIR). This is to inform third parties about them. In parallel, the adversarial part of the proceedings is opened and the parties are invited to submit observations (and, if applicable, proof of use).

There are usually two rounds of observations, after which the adversarial part is closed and the file is ready for a decision. Once the decision becomes final (i.e. if no appeal has been filed within the prescribed time limit or when the appeal proceedings are closed), the Office will make the corresponding entry in the Register, in accordance with Article 57(6) CTMR.

In many respects, cancellation proceedings follow the same or analogous procedural rules as those established for opposition proceedings (e.g. friendly settlement, restrictions of the contested CTM and withdrawals of the application for cancellation, correction of mistakes and revocation, time limits, multiple cancellations, change of parties, *restitutio*, etc.). For all these matters, see the relevant sections of the Guidelines and in particular Part C, Opposition, Section 1, Procedural Matters. This part of the Guidelines will, therefore, only focus on those aspects of the cancellation proceedings that are different from opposition proceedings.

2 Application for Cancellation

2.1 Persons entitled to file an application for cancellation

Articles 41(1) and 56(1) CTMR

Cancellation proceedings can never be initiated *ex officio* by the Office but only upon receipt of an application from a third party.

Applications for revocation or for invalidity based on absolute grounds (Articles 51 and 52 CTMR) may be filed by:

1. any natural or legal person, or
2. any group or body set up for the purpose of representing the interests of manufacturers, producers, suppliers or services, traders or consumers, which under the terms of the law governing it has the capacity in its own name to sue and be sued.

As regards applications for revocation or for invalidity based on absolute grounds, the applicant does not need to show an individual interest in bringing proceedings (judgment of 08/07/2008, T-160/07, COLOR EDITION, EU:T:2008:261, § 22-26, confirmed by judgment of 25/02/2010, C-408/08 P, COLOR EDITION, EU:C:2010:92, § 37-40). This is because, while relative grounds for invalidity protect the interests of proprietors of certain earlier rights, the absolute grounds for invalidity and for revocation aim to protect the general interest (including, in the case of revocations based on lack of use, the general interest in revoking the registration of trade marks that do not satisfy the use requirement) (judgment of 30/05/2013, T-396/11, ULTRAFILTER INTERNATIONAL, EU:T:2013:284, § 17-18).

In contrast, applications for invalidity based on relative grounds (Article 53 CTMR) may only be filed by the persons mentioned in Article 41(1) CTMR (in the case of applications based on Article 53(1) CTMR) or by those entitled under the law of the Member State concerned to exercise the rights in question (in the case of applications based on Article 53(2) CTMR).

Applications for revocation or invalidity based on Articles 73 or 74 CTMR (in particular specific revocation and absolute grounds for collective marks) follow the same rules, with regard to entitlement, as applications for revocation or for invalidity based on absolute grounds (Article 66(3) CTMR).

2.2 Written applications

Article 56(2) CTMR

An application for cancellation has to be filed in writing. It is not obligatory to use the forms provided by the Office, as long as all the admissibility requirements are met. However, the use of the official forms is highly recommended.

3 Payment of the Fee

Article 56(2) CTMR
Rule 39(1) CTMIR
Article 8(3) CTMFR

For general rules on payments, see the Guidelines, Part A, General Rules, Section 3, Payment of Fees, Costs and Charges.

An application for cancellation is not deemed to have been filed until the fee has been paid. For this reason, before examining the admissibility of the application, the Office will first check that the fee has been received.

Where the Office finds that the fee has not been paid, it will invite the applicant to pay it within a given time limit (in practice usually one month). If the required fee is not paid within the time limit, the Office will inform the applicant that the application for cancellation is deemed not to have been filed. If the fee is paid, but after the specified time limit, it will be refunded to the applicant. In cases where the fee is received after the expiry of the time limit specified by the Office but the applicant provides proof that, within the time limit, it duly gave an order to a banking establishment to transfer the amount of the payment in a Member State, Article 8(3) CTMFR will be applied, including the payment of a surcharge where applicable (see the Guidelines, Part A, General Rules, Section 3, Payment of Fees, Costs and Charges).

The filing date of an application for cancellation is not affected by the date of payment of the fee, since Article 56(2) CTMR is a rule of order in the context of cancellation proceedings and does not establish any consequence as regards the filing date of the application. Therefore, when the fee is paid before the expiry of the time limit specified by Rule 39(1) CTMIR, the application is deemed to be filed and the filing date will be that on which the written statement was received by the Office.

As a general principle, the cancellation fee is an application fee due for the filing of the application regardless of the outcome of the proceedings. Therefore, it will not be refunded in cases of inadmissibility.

Neither will the cancellation fee be refunded in cases where the application for cancellation is withdrawn at any stage.

In this context, the only provision that foresees the refund of the cancellation fee is Rule 39(1) CTMIR, applicable only in cases where the application is deemed not to have been filed as a result of a late payment.

4 Admissibility Check

Article 51 and Articles 53(4) and 56(3) CTMR
Rule 37 and Rule 38(1) CTMIR

Once the Office has established that the corresponding fee has been duly paid, it proceeds with an admissibility check of the application.

In contrast to opposition proceedings, there is no cooling-off period and no subsequent time limit for substantiation in cancellation proceedings. This means, in particular, that in the case of an application for invalidity based on relative grounds the proof of the existence, validity and scope of protection of all the earlier rights and the evidence proving the applicant's entitlement to them have to be filed, in principle, together with the application.

The admissibility check may result in the identification of absolute and/or relative admissibility deficiencies in the application.

Absolute admissibility deficiencies are those that cannot be remedied by the applicant and will automatically lead to the application being considered inadmissible, such as the following:

- The application is filed against a CTM that has not yet been registered. An application for cancellation can only be filed against a registered CTM. A request directed against an application that has not yet been registered is premature and should be rejected as inadmissible (decision of 22/10/2007, R 0284/2007-4, VISION).
- The application is filed against a CTM that no longer exists at the time of filing, since it has already been surrendered, has expired, or has been revoked or invalidated by a final decision.
- There is a previous final decision by the Office or by a court in a Member State on a cancellation application or counterclaim relating to the same subject matter and cause of action, and involving the same parties (Article 56(3) CTMR). For more details on this admissibility deficiency, see the corresponding section in the Guidelines, Part D, Cancellation, Section 2, Substantive Provisions, paragraph 5.
- In cases of invalidity based on relative grounds, where the applicant owns several earlier rights and has previously applied for the invalidity of the same CTM (or made a counterclaim) on the basis of another of those earlier rights that could have been invoked in the previous application or counterclaim (Article 53(4) CTMR). For more details on this admissibility deficiency, see the corresponding section in the Guidelines, Part D, Cancellation, Section 2, Substantive Provisions, paragraph 4.5.2.
- An application for revocation based on non-use is filed against a trade mark that has not been registered for five years at the date of the application (Article 51 CTMR).
- An application for cancellation filed without having used the official form, which is neither in the correct language as established in Article 119 CTMR nor translated into that language within one month of the filing of the application for cancellation (Rule 38(1) CTMR).

Where an absolute admissibility deficiency is found, the Office will invite the applicant to comment on the inadmissibility within two months. If, after hearing the applicant, the Office still maintains that there is an absolute admissibility deficiency, a decision will be issued rejecting the application for cancellation as inadmissible.

Relative admissibility deficiencies, on the other hand, are those that can in principle be remedied by the applicant. They include non-compliance with one or more of the

relative admissibility requirements contained in Rule 37 CTMIR (which are described in detail in paragraph 4.1 below). In these cases, in accordance with Rule 39(3) CTMIR, the Office will invite the applicant to remedy the deficiency within two months (see paragraph 4.2 below).

Where one or more relative admissibility deficiencies have been found and they are not remedied within the specified time limit, a decision will be issued rejecting the application for cancellation as inadmissible.

Any decision to reject an application for cancellation in its entirety as inadmissible will be communicated to the applicant and the proprietor of the CTM (Rule 39(4) CTMIR) and can be appealed by the applicant.

However, if the result of the admissibility check is that the application is considered partially admissible (i.e. admissible for at least some of the grounds and/or earlier rights on which it is based), the proceedings will continue. If one of the parties disagrees with the result of the admissibility check, it can appeal against it together with the final decision terminating the proceedings (Article 58(2) CTMR).

4.1 Relative admissibility requirements (Rule 37 CTMIR)

The relative admissibility requirements laid down by Rule 37 CTMIR are set out below.

4.1.1 Registration number of the contested CTM and name and address of its owner (Rule 37(a)(i) and (ii) CTMIR)

An application for cancellation must contain the CTM registration number and the name and address of its proprietor (please note that this is different in opposition proceedings, where Rule 15(2)(a) CTMIR only requires the opponent to identify the contested CTMA and the name of the applicant, but not its address).

The Office will check that the proprietor's name and address correspond to the CTM identified by its registration number. In the event of discrepancies (or omission of one of these details), a deficiency letter will be sent to the applicant inviting it to remedy this deficiency (see the paragraphs on deficiencies below).

4.1.2 Extent of the application for cancellation (Rule 37(a)(iii) CTMIR)

The applicant must indicate whether the request is filed against all the goods and services or against part of the goods and services in the contested registration. In the latter case, the applicant will have to clearly identify the specific goods and services in a list.

An applicant is entitled to limit the scope of its application by excluding subcategories of the goods and/or services for which the contested mark is registered (see, as regards applications for revocation, judgment of 09/12/2014, T-307/13, ORIBAY, EU:T:2014:1038, § 25).

Please note the difference from opposition proceedings where, for the purposes of admissibility, the extent of the opposition is only an optional indication (Rule 15(3)(a) CTMIR).

4.1.3 Grounds of the application for cancellation and facts, evidence and arguments presented in support of those grounds (Rule 37(b) CTMIR)

The CTMR and CTMIR clearly distinguish between an application for revocation and an application for a declaration of invalidity. Therefore, revocation and invalidity grounds cannot be combined in a single application but must be subject to separate applications and entail the payment of separate fees. However, an application for revocation can be based on several revocation grounds and an application for invalidity can be based on a combination of absolute and relative grounds. If an applicant files a single application based on revocation and invalidity grounds, the Office will send a deficiency letter inviting the applicant to choose one or the other type of grounds and will inform the applicant that another cancellation application can be filed subject to the payment of an additional application fee. If the applicant does not indicate which type of grounds it wishes to choose within the time limit specified, the application will be rejected as inadmissible (Rule 39(3) CTMIR).

An application for cancellation must contain an indication of the grounds on which it is based, that is to say the specific provisions of the CTMR that justify the requested cancellation. The applicant may limit the grounds on which the application was initially based but may not enlarge the scope of the application by claiming any additional grounds during the course of the proceedings.

In addition, where an application for invalidity is based on relative grounds (Article 53 CTMR), the application must contain particulars of the right or rights on which the application is based and, if necessary, particulars showing that the applicant is entitled to adduce the earlier right as grounds for invalidity (meaning all the indications contained in Rule 15(b), (d), (e), (f), (g) and (h) CTMIR, which are applied by analogy).

According to Rule 37(b)(iv) CTMIR, an application for cancellation must also contain an indication of the facts, evidence and arguments presented in support of the cancellation grounds. This means that the mere submission of an application form in which all the relevant boxes are ticked, but that does not include any explanation on the ground(s) in the relevant box or attach any observations or evidence, such as a certificate, will lead to an admissibility deficiency. The only exception is for applications for revocation based on non-use (Article 51(1)(a) CTMR), in which the burden of proof is on the CTM proprietor.

Finally, an important distinction should be drawn between admissibility and substantiation requirements. As already mentioned in the introduction to paragraph 4, even though in invalidity proceedings based on relative grounds there is no time limit for the substantiation of the earlier rights, and the proof of the existence, validity and scope of protection of all the earlier rights and the evidence proving the applicant's entitlement to them have to be filed together with the application, this does not mean that there is no distinction between admissibility and substantiation requirements. If, for instance, an applicant clearly identifies the earlier mark on which the application is based (Rule 37(b)(ii) CTMIR) and indicates the evidence or submits some arguments in support of those grounds (Rule 37(b)(iv) CTMIR), the application will be admissible. If the evidence or arguments provided are later found insufficient to substantiate the earlier right (e.g. the certificate is not from an official source or not translated into the language of proceedings), the application will be rejected as unfounded (see, by analogy, Rule 20(1) CTMIR) and not as inadmissible (decisions of 12/07/2013, R 1306/2012-4, URB EUROPE, § 21; 12/07/2013, R 1310/2012-4, URB Bearings,

§ 21; 12/07/2013, R 1309/2012-4, URB, § 20, confirmed by judgment of 07/11/2014, T-506/13, URB, EU:T:2014:940).

However, the absence of a time limit for the substantiation of the earlier rights means that at any subsequent stage of the proceedings (before the closure of the adversarial part) the applicant can remedy, on its own motion, any deficiency as regards substantiation.

Examples to illustrate the difference between admissibility and substantiation, in particular as regards earlier rights:

- 1) An application for cancellation pursuant to Article 53(1) CTMR does not contain a representation of the earlier right on which it is based, neither in the corresponding box in the form nor in the attached documentation. Since a representation of the mark (in colour if applicable) is one of the requirements for clearly identifying the earlier right (Rule 15(2)(e) CTMIR by analogy), there will be a relative admissibility deficiency in accordance with Rule 37(b)(ii) CTMIR, which the applicant will be invited to remedy (see paragraph 4.2 below).
- 2) An application for cancellation pursuant to Article 53(1)(a) in conjunction with Article 8(1)(b) CTMR includes all the necessary particulars of the earlier national mark (e.g. all the relevant boxes of the corresponding page of the official form are correctly filled in), including the indications as to the entitlement of the applicant. However, the certificate attached to the application indicates that the owner is a different person. In this case the applicant has complied with both Rule 37(b)(ii) and (iv) CTMIR, that is to say it has given particulars of the earlier right and of its entitlement, and submitted evidence in support. Whether the evidence submitted is sufficient to substantiate its claims is not a matter of admissibility, but of substantiation. The applicant will not be invited to remedy the substantiation deficiency, but must do so on its own motion before the closure of the adversarial part of the proceedings (e.g. by submitting evidence that the transfer of the earlier national mark to the applicant had taken place before the filing of the cancellation application).
- 3) An application for cancellation pursuant to Article 53(1)(c) in conjunction with Article 8(4) CTMR includes all the necessary particulars about the earlier right and also contains evidence in support of the cancellation grounds, but the evidence is clearly insufficient (e.g. the applicant does not provide any indication regarding the applicable national law). Again, and for the same reasons as in the previous example, the application would be admissible but unsubstantiated, unless the applicant were to remedy the substantiation deficiency on its own motion before the closure of the adversarial part of the proceedings.

As regards substantiation requirements of earlier rights, see the section on proof of existence of earlier rights in the Guidelines, Part C, Opposition, Section 1, Procedural Matters and the section on invalidity proceedings based on relative grounds in the Guidelines, Part D, Cancellation, Section 2, Substantive Provisions.

4.1.4 Identification of the applicant (Rule 37(c) CTMIR)

An application for cancellation must contain the applicant's name and address and, if the applicant has appointed a representative, the representative's name and address. Applicants that do not have either their domicile or their principal place of business or a

real and effective industrial or commercial establishment in the European Union must be represented by a professional representative (Article 92(2) CTMR). For more information, see the Guidelines, Part A, General Rules, Section 5, Professional Representation.

Concerning multiple applicants, applications for invalidity based on relative grounds follow the same rules as oppositions (see the Guidelines, Part C, Opposition, Section 1, Procedural Matters). These rules are directly connected to the entitlement requirements of Articles 41(1) and 56(1) CTMR (see above).

In contrast, in the case of applications for invalidity based on absolute grounds and for revocation there are no particular requirements regarding multiple applicants, except that they have to be clearly indicated in the application.

Please note that in all cases concerning multiple applicants, Rule 75 and Rule 94(7)(e) CTMIR will be applied (appointment of a common representative and fixing of costs).

4.2 Invitation to remedy deficiencies

Rule 39(3) and (4) CTMIR

In accordance with Rule 39(3) CTMIR, if the Office finds that an application for cancellation does not comply with Rule 37 CTMIR, it will invite the applicant to remedy the deficiencies within a specific time limit. Please note that this only applies to deficiencies as regards admissibility requirements, and not to deficiencies as regards substantiation requirements, which the applicant must remedy on its own motion (see paragraph 4.1.3 above).

If the deficiencies are not remedied before the expiry of the time limit, the Office will issue a decision rejecting the application as inadmissible. In cases where the application for cancellation is based on several grounds and/or earlier rights and the deficiencies only relate to some of them, the proceedings can continue in relation to the other grounds or earlier rights for which there are no admissibility deficiencies (partial admissibility).

As mentioned above in connection with the grounds of the application, in the context of Rule 39(3) CTMIR, the fact that the applicant is invited to remedy a deficiency cannot lead to enlargement of the scope of the proceedings (earlier rights, goods and services, etc.) determined by the initial request.

Finally, Rule 39(3) CTMIR is only applicable to the list of relative admissibility requirements contained in Rule 37 CTMIR. Deficiencies in relation to absolute admissibility requirements are not covered by Rule 39(3) CTMIR and cannot be remedied (i.e. they lead to the rejection of the application in question as inadmissible).

5 Notification of the Application to the CTM Proprietor and Further Exchanges between the Parties

Article 57 CTMR
Rule 40 CTMIR

Rule 40(1) CTMIR states that every application for cancellation that is deemed to have been filed must be notified to the proprietor of the contested CTM and that when the Office has found the application admissible, it will invite the proprietor to file its observations within such time limit as it may specify.

Therefore, once the Office has verified that payment has been received (and thus the application is deemed to have been filed) and has carried out the admissibility check, it notifies the CTM proprietor of the application for cancellation.

If no deficiencies are detected in the admissibility check, the notification of the application to the CTM proprietor will also contain an invitation to file observations (and in the case of an application for revocation based on Article 51(1)(a) CTMR, an invitation to submit proof of genuine use — see Rule 40(5) CTMIR). In practice, the Office grants the CTM proprietor three months for its first reply to the application.

If the admissibility check reveals that there are deficiencies to be remedied, the CTM proprietor will still be notified of the application and will be informed of the deficiencies that the applicant has to remedy. However, in this case just the notification of the application is sent and the Office will not invite the CTM proprietor to file observations (or, where applicable, proof of use) until the applicant has remedied the deficiencies.

According to the judgment of the Court of Justice of 18/10/2012 in case C-402/11 P, REDTUBE, EU:C:2012:649 (applicable by analogy to cancellation proceedings), the notification sent to the parties after the admissibility check informing them that the cancellation is admissible in accordance with Rule 37 CTMIR constitutes a decision that may be appealed together with the final decision on the case as stated in Article 58(2) CTMR. Consequently, the Office is bound by this decision and may only revoke it at a later stage of the proceedings provided that the requirements stated in Article 80 CTMR for the revocation of decisions are met. This means that, for instance, if an admissibility deficiency is found after the application has been notified, it should first be determined whether the decision on admissibility can still be revoked and, if so, the Office will issue the corresponding deficiency letter once the previous decision on admissibility has been revoked.

Revocation does not occur where the cause of inadmissibility arises **after** the initial admissibility check (e.g. when an applicant outside the EU ceases to have a representative and does not appoint one or when res judicata applies because a pertinent decision becomes final during the cancellation proceedings). In such cases the Office will again check the admissibility and issue the corresponding deficiency letter without revoking the previous admissibility decision (which did not contain any error at the time it was adopted).

According to Article 57(1) CTMR, the Office may invite the parties to file observations as often as it considers this necessary. In practice, and in the interest of avoiding an unnecessary prolongation of the proceedings, the Office will usually grant two rounds of observations, usually ending with those of the CTM proprietor (i.e. application for cancellation — CTM proprietor's observations — applicant's observations — CTM

proprietor's observations). Nevertheless, in cases when one of the parties, within the time limit to file observations, does not submit any evidence or observations and/or indicates that it has nothing more to comment, the Office may directly proceed to closure of the adversarial part of the proceedings, notifying the parties that a decision will be taken.

However, additional rounds of observations may be granted in exceptional cases, in particular when additional relevant evidence, which could not have been filed beforehand, is filed in the last round. It is the Office's practice to give the parties a time limit of two months to file their observations (except for the first submission of the CTM proprietor, see above).

As regards applications for invalidity based on relative grounds, the CTM proprietor may also file a request for proof of use of the earlier trade marks on which the application is based. If the request is admissible (for the rules on the admissibility of a request for proof of use, see the Guidelines, Part C, Opposition, Section 6, Proof of Use), the Office will invite the applicant to submit the proof (Article 57(2) and (3) CTMR and Rule 40(6) CTMIR). In contrast to opposition proceedings (Rule 22(1) CTMIR), in cancellation proceedings, the request can be filed by the CTM proprietor together with its first reply to the application or in any of the subsequent rounds of observations.

Once the parties have submitted their observations and/or proof of use (if applicable), the adversarial part is closed and the file is ready for decision.

If at any stage of the proceedings one of the parties does not file observations within the specified time limit, the Office will close the adversarial part and take a decision on the basis of the evidence before it (Rule 40(2) CTMIR, applicable by analogy to both parties).

In cases of invalidity based on relative grounds, before the Office issues a decision, it will check whether any of the earlier rights invoked that were correctly substantiated by the applicant have become due for renewal afterwards. If so, and provided it could be relevant for the outcome of the proceedings, the Office will invite the applicant to prove the renewal of the earlier right. If the applicant does not submit the proof, the application will be rejected as non-substantiated to the extent it is based on the earlier right.

As regards the rules on time limits, extensions, notification or change of parties in the course of proceedings, etc., see the Guidelines, Part C, Opposition, Section 1, Procedural Matters, as the rules are applicable *mutatis mutandis*.

6 Languages Used in Cancellation Proceedings

Article 119(5), (6) and (7) CTMR
 Rules 38(1) and (3); 39(2) and (3); 96(1) and (2) CTMIR

The language of cancellation proceedings will in general be determined by the applicant in the cancellation application and has to comply with Article 119 CTMR (i.e. it has to be one of the five languages of the Office and one of the two languages chosen by the CTM proprietor when it applied for the contested trade mark). For detailed rules on how to determine the language of proceedings, see the Guidelines, Part C, Opposition, Section 1, Procedural Matters, paragraph 2.3.

The parties to cancellation proceedings may also agree on a different official language of the European Union as the language of the proceedings (Article 119(7) CTMR). This agreement has to be communicated to the Office within two months of the notification of the application for cancellation to the CTM proprietor. In this case, the applicant must file a translation of the application into the language chosen by both parties (where it was not already filed in that language) within one month of the date on which the agreement is communicated to the Office. Where the translation is not filed or filed late, and where the request to change the language is filed late (after the expiry of the two months), the language of the proceedings will remain unchanged (Rule 38(3) CTMIR).

6.1 Translation of the application for cancellation

Article 119(6) CTMR
 Rules 38(1) and (3) and 39(2) CTMIR

If the application is filed in a language of the Office that is not one of the two languages of the contested CTM, on its own motion the applicant has to file a translation into the correct language (either of the two languages of the contested CTM, if they are both languages of the Office, or the second language of the contested CTM, when the first is not a language of the Office) within one month of the filing date of the application for cancellation, failing which the application will be rejected as inadmissible (Article 119(6) CTMR, Rules 38(1) and 39(2) CTMIR).

Rule 39(3) CTMIR, regarding the invitation to the applicant to remedy deficiencies, does not refer to Rule 38(1) CTMIR and, therefore, in these cases the Office will not send a deficiency letter and will wait for one month after the filing date for the translation of the cancellation application to be submitted.

Where the applicant uses the official form for revocation or invalidity, and this form is in the wrong language, there may be exceptions concerning the translation of the application. Please see the different scenarios described in the Guidelines, Part C, Opposition, Section 1, Procedural Matters, paragraph 2.3.

6.2 Translation of the evidence submitted by the applicant in support of the application

Rules 38(2) and 39(3) CTMIR

According to Rule 38(2) CTMIR, where the evidence in support of the application is not filed in the language of the revocation or invalidity proceedings, the applicant must file, on its own motion, a translation into that language within two months of the filing date of the evidence in support of the application. This applies to all the evidence submitted by the applicant in the course of the proceedings, whether it is filed together with the application or at a later stage.

The Office will not send a deficiency letter and it is up to the applicant to submit the translation of the evidence in support of the application on its own motion.

If the applicant does not file a translation of evidence in support of the application that is required to evaluate the admissibility of the case (e.g. the particulars of the earlier right on which the application is based, or the indication of the facts, evidence and arguments in support of the grounds are not translated), the Office will invite the applicant to remedy the deficiency pursuant to Rule 39(3) CTMIR (decision of 02/03/2007, R 0300/2006-4, ACTILON/AC TELION). If the deficiency is not remedied, the application for cancellation will be rejected as totally or partially inadmissible (Article 119(6) CTMR, Rules 38(2) and 39(3) CTMIR).

If the applicant does not provide translations for the other evidence, which would not affect the admissibility of the case, any document in support of the application that is not translated by the applicant into the language of proceedings within the time limit specified in Rule 38(2) CTMIR will be deemed not to have been received by the Office and, therefore, will not be taken into account (Rule 98(2) CTMIR) (decision of 05/03/2012, R 0826/2010-4, MANUFACTURE PRIM 1949 (fig.), § 25).

6.3 Translation of observations submitted by the parties in the course of the proceedings

Rules 96(1) and 98(2) CTMIR

A party who submits observations in a language of the Office other than the language of the proceedings has to file a translation of those observations in the language of the proceedings within one month of the submission date (Rule 96(1) CTMIR).

The Office will not ask for the translations and will proceed with the case. It is up to the party to submit the requisite translations.

If the translations are not submitted within the time limit of one month, the observations will be deemed not to have been received by the Office and, therefore, will not be taken into account (Rule 98(2) CTMIR).

6.4 Translation of evidence submitted by the CTM proprietor in the course of the proceedings

Rules 96(2) and 98(2) CTMIR

The documents submitted by the CTM proprietor in the course of the proceedings (except for proof of use, see below) are subject to Rule 96(2) CTMIR and, therefore, may be submitted in any official language of the European Union.

In accordance with this provision, the CTM proprietor is not automatically obliged to file a translation, but the Office may require it to do so within a time limit. In exercising its discretion in this matter, the Office will take into account the nature of the evidence and the interests of the parties.

In cases where the Office does invite the CTM proprietor to submit translations of the evidence, failure to do so within the specified time limit will mean that the non-translated documents will not be taken into account (Rule 98(2) CTMIR).

6.5 Translation of proof of use

Rule 22(6) CTMIR

Although Rule 40(5) and (6) CTMIR only expressly refer to Rule 22(2), (3) and (4) CTMIR, it is considered that Rule 22(6) CTMIR should also be applied by analogy in cancellation proceedings, since the underlying logic is the same, that is to say to request translation of evidence, which for proof of use tends to be quite lengthy, only to the extent to which it is considered necessary (decision of 11/03/2010, R 0167/2009-1, INA/INA (fig.), § 24-25). Consequently, Rule 22(6) CTMIR applies as *lex specialis*, vis-à-vis the *lex generalis* contained in Rule 38(2) CTMIR (evidence submitted by the applicant) and Rule 96(2) CTMIR (evidence submitted by the CTM proprietor), as regards proof of use submitted by either of the parties (judgment of 13/02/2015, T-287/13, HUSKY, EU:T:2015:99, § 55).

According to Rule 22(6) CTMIR, where the evidence of use filed by one of the parties is not in the language of the proceedings, the Office *may* require the party that filed it to submit a translation of the evidence in that language within a time limit of two months. In exercising its discretion in this matter, the Office will take into account the nature of the evidence and the interests of the parties. In cases where the Office does invite the CTM proprietor to submit translations of the evidence, failure to do so within the specified time limit will mean that the non-translated documents will not be taken into account (except those that are considered to be self-explanatory). For further guidance on the application of Rule 22(6) CTMIR, see the Guidelines, Part C, Opposition, Section 1, Procedural Matters and Part C, Opposition, Section 6, Proof of Use.

7 Other Issues

7.1 Continuation of proceedings

Article 82 CTMR

According to Article 82(1) CTMR, any party to proceedings before the Office that has omitted to observe a time limit vis-à-vis the Office may, upon request, obtain the continuation of proceedings, provided that at the time the request is made the omitted act has been carried out. The request for continuation of proceedings will be admissible only if it is presented within two months of the expiry of the unobserved time limit and will not be deemed to have been filed until the corresponding fee has been paid.

This provision is applicable to all the proceedings before the Office. For more details, see the Guidelines, Part A, General Rules, Section 1, Means of Communication, Time Limits.

However, the reason why it is specifically mentioned in relation to cancellation proceedings is to highlight the difference with opposition proceedings. As regards opposition, Article 82(2) CTMR establishes that continuation of proceedings is not applicable, inter alia, to the time limits laid down in Articles 41 and 42 CTMR (period for filing notice of opposition, time limits given by the Office to file facts, evidence and arguments or observations). In cancellation proceedings, by contrast, continuation of proceedings can be requested for any of the different time limits within the cancellation proceedings (except for the time limit established in Article 60 CTMR to file an appeal).

7.2 Suspensions

Article 104 CTMR

In the matter of suspensions, see in general the Guidelines, Part C, Opposition, Section 1, Procedural Matters (taking into account, however, that in cancellation proceedings there is no cooling-off period). Rule 20(7) CTMIR is applicable by analogy.

The main particularity of cancellation proceedings in this matter concerns the specific rules on related actions before Community trade mark courts. According to Article 104(2) CTMR, the Office, when hearing an application for cancellation will, unless there are special grounds for continuing the hearing, of its own motion after hearing the parties or at the request of one of the parties and after hearing the other parties, suspend the proceedings where the validity of the contested CTM is already in issue on account of a counterclaim before a Community trade mark court.

Article 104(2) CTMR also states that if one of the parties to the proceedings before the Community trade mark court so requests, the Community trade mark court may, after hearing the other parties to these proceedings, suspend the proceedings. The Office will in this case continue the proceedings pending before it.

A request for suspension pursuant to Article 104(2) CTMR should be supported by relevant evidence. Suspension requests are only considered relevant to the proceedings and might be granted under Article 104(2) CTMR in cases where they

refer to the contested CTM and not where they refer to other CTMs contested in parallel cancellation proceedings.

7.3 Surrenders and withdrawals

The Office's practice on the surrender of CTMs is described in the Guidelines, Part E, Register Operations, Section 1, Changes in a Registration.

7.3.1 Surrenders covering all the contested goods and/or services

In principle, the consequences in cancellation proceedings of a total surrender of the contested CTM (or of a partial surrender covering all the goods and/or services against which the application for cancellation is directed) are similar to those of the withdrawal of a CTM application in opposition proceedings.

However, unlike what happens with the withdrawal of a CTM application, the effects of the surrender of a registered CTM are not the same as those of the decision on the substance terminating the proceedings in question. While the surrender of a CTM only becomes effective on the date on which the surrender is registered, a decision cancelling the CTM produces its effects from an earlier date, be it from the outset (in the case of invalidity) or from the date on which the cancellation request was filed (in the case of revocation). Consequently, as a rule, and despite the surrender of the contested CTM, the applicant is deemed still to have a legitimate interest in continuing the cancellation proceedings in order to obtain a decision on the substance (judgment of 24/03/2011, C-552/09 P, TiMi KiNDERJOGHURT, EU:C:2011:177, § 39 and decision of 22/10/2010, R 0463/2009-4, MAGENTA, § 25-27).

In practice, when there is a surrender of a CTM that is subject to cancellation proceedings, the Office will suspend the registration of the surrender and, in parallel, the Cancellation Division will notify the cancellation applicant of the surrender, inviting it to submit observations within two months and to indicate whether it wishes to continue the proceedings or whether it agrees to the closure of the proceedings without a decision on the substance. This letter will also inform the applicant that, if it does not reply, the cancellation proceedings will be closed without a decision on the substance.

If the applicant replies and expressly agrees with the closure of the proceedings, the surrender will be recorded, the cancellation action will be deemed to have been withdrawn and the proceedings will be closed without a decision on the substance. The costs will be borne by the CTM proprietor (Article 85(3) CTMR).

If the applicant does not submit any observations on the closure of the cancellation proceedings, the Cancellation Division will send both parties a letter closing the proceedings and informing the applicant of its possible loss of rights for the purposes of Rule 54(2) CTMIR. If the applicant does not explicitly apply for a decision on the matter within the time limit established in this rule, the surrender will be recorded in the Register.

If the applicant does request the continuation of the cancellation proceedings (either in reply to the Office's invitation to submit observations or when applying for a decision under Rule 54(2) CTMIR), the cancellation proceedings will continue until there is a final decision on the substance. In these cases, the costs will be borne by the losing party and not necessarily the party terminating proceedings as indicated in Article 85(3)

CTMR. After the decision on the cancellation has become final, the surrender will be recorded only for the goods and/or services for which the contested CTM has not been revoked or declared invalid, if any.

7.3.2 Surrenders covering only a part of the contested goods and/or services

The CTM proprietor may partially surrender its CTM for part of the contested goods and/or services. In such cases the Office will notify the cancellation applicant and will invite it to indicate if it wishes to maintain its cancellation application. If the cancellation applicant does request the continuation of proceedings and maintains its application for cancellation, proceedings will continue despite the partial surrender of the CTM in the Register. If the cancellation applicant does not wish to maintain its application for cancellation, the Office will close the proceedings and take a decision on costs indicating that each party will bear its own costs (Article 85 (2) CTMR).

7.3.3 Withdrawals

The cancellation applicant can withdraw its application for cancellation at any time of the proceedings. The Office will inform the CTM proprietor about the withdrawal, close the proceedings and take a decision on costs, which will be borne by the applicant (Article 85(3) CTMR), except in cases where the withdrawal immediately follows a surrender (see above).

The parties may indicate that a surrender or a withdrawal is a consequence of an agreement they have reached and that a decision on costs is not necessary. The Office will not issue a decision on costs if such a request is received together with a request for surrender or withdrawal and is signed by both parties. Such a request can also be sent in two separate letters to the Office. In cases where no indication is given as to whether the parties have agreed on the costs, the Office will take a decision on costs immediately. The decision on costs already issued will not be revised by the Office in the event that the parties provide such information after the date of the decision. It is left to the parties to respect the agreement and not to 'execute' the Office's decision on costs.

7.4 Applications for revocation and for invalidity against the same CTM

If the same CTM is subject to both revocation and invalidity proceedings, the Office has the power of discretion to decide in each case, taking into account the principles of economy of proceedings and administrative efficiency, whether one of the proceedings has to be suspended until the other is terminated or in which order the proceedings should be decided.

If it is first decided that the CTM is totally invalid (or partially, but for all the goods/services against which the revocation is directed), and once this decision becomes final, the parallel revocation proceedings will be automatically closed since they no longer have any object. The costs are at the discretion of the Office (Article 85(4) CTMR), which will usually conclude that each party has to bear its own costs.

However, taking into account the different effects of a revocation (*ex nunc*) and of a declaration of invalidity (*ex tunc*), when it is first decided that the CTM should be totally revoked (or partially, but for all the goods/services against which the invalidity is directed), the Office will inform the applicant of this decision when it becomes final and will invite it to submit its observations on the closure of the invalidity proceedings. If the applicant demonstrates a sufficient legal interest in obtaining a declaratory invalidity decision, the proceedings will continue.

7.5 Contested international registrations designating the EU

Article 152(2) and Article 158 CTMR

Cancellation proceedings can also be directed against international registrations (IRs) designating the European Union. The specific rules that are applicable in these cases (in particular in connection with the filing date and the relevant time limit for proof of use) can be found in the Guidelines, Part M, International Marks.

A cancellation application against an IR may be filed after the date of the publication of the IR designating the European Union in the Official Bulletin of the Office (M.3.1. — International registrations with or without amendments since their publication under Article 152(1) of the CTMR).

As regards WIPO representatives of the holders of contested IRs, the Office will as a general rule communicate with them, irrespective of the IR holder's location, when they comply with the criteria of Article 93 CTMR.

Where the WIPO representative of the IR holder does not comply with the criteria of Article 93 CTMR, the notification of the cancellation application will be sent directly to the IR holder, and a copy will be sent to its WIPO representative for information purposes.

The notification of the cancellation application will also invite the IR holder to appoint a professional representative in accordance with Article 93 CTMR within three months of its receipt. In cases of obligatory representation (Article 92(2) CTMR), the notification will indicate the consequences of not complying with this requirement (namely, that any communications sent by the IR holder in the course of the proceedings will not be taken into account).

***GUIDELINES FOR EXAMINATION IN THE
OFFICE FOR HARMONIZATION IN THE
INTERNAL MARKET (TRADE MARKS AND
DESIGNS) ON COMMUNITY TRADE MARKS***

PART E

REGISTER OPERATIONS

SECTION 2

CONVERSION

Table of Contents

1	Introduction.....	3
2	Conversion of CTMs and IRs Designating the EU	3
2.1	Conversion of CTMs.....	3
2.2	Conversion of IRs designating the EU.....	4
3	Valid CTM Application as a Condition for Conversion.....	5
4	Grounds Precluding Conversion	5
4.1	Revocation on the grounds of non-use	6
4.2	Ground for refusal limited to a Member State or extended to the entire EU	6
4.3	Withdrawal/surrender after a decision has been rendered	7
4.4	Competence to decide on grounds precluding conversion	8
5	Formal Requirements for the Request of Conversion.....	8
5.1	Time limit	8
5.1.1	Start of time limit where the Office issues a notification	8
5.1.2	Start of time limit in other cases	8
5.2	Request for conversion.....	9
5.3	Language	11
5.4	Fee.....	12
6	Examination by the Office.....	12
6.1	Stages of the procedure, competence	12
6.2	Examination.....	13
6.2.1	Fees.....	13
6.2.2	Time limit	13
6.2.3	Language.....	13
6.2.4	Formalities	14
6.2.5	Grounds	14
6.2.6	Representation	15
6.2.7	Partial conversion	15
6.3	Publication of the request and entry in the Register	16
6.4	Submission to designated offices.....	16
7	Effects of Conversion.....	18

1 Introduction

Conversion is the process of turning a CTM into one or more national applications. Its main features are laid down in Articles 112 to 114 CTMR and Rules 44 to 47 CTMIR. If a CTM ceases to exist it can, depending on the precise reason for that, be converted into trade marks that are valid in certain Member States. Conversion is particularly useful for overcoming possible problems with the CTM's unitary character. For example, if the Community trade mark faces a registrability problem in only one or certain countries on absolute grounds or due to an opposition based on an earlier right valid in only one country or certain countries, the CTM applicant can apply to convert the CTM into individual, national trade mark applications in the other countries not affected by these grounds.

The Community Trade Mark system is based on the principle that the Community and national trade mark systems are complementary. They are notably linked to each other by seniority and conversion procedures. The system is construed in such a way that the earlier filing date of a registered right will always prevail in the territory in which it is valid, irrespective of whether the registered trade mark results from a national filing, an international designation or a CTM application (decision of the Grand Board of Appeal, 15/07/2008, R 1313/2006-G, and decision of 22/09/2008, R 0207/2007-2, Restoria, § 34).

Conversion is a two-tier system involving, firstly, the payment of the conversion fee of EUR 200 and the examination of the conversion application before the Office and, secondly, the conversion procedure itself before the national offices. Depending on national law, the converted trade mark will either be registered immediately or enter the national examination, registration and opposition procedure like a normal national trade mark application.

Where the EU is designated in an IR and to the extent that the designation has been withdrawn, refused or has ceased to have effect, a request may also be made for conversion into national trade mark applications in one, more or all of the Member States or through a subsequent designation of the Member States under the Madrid system.

Conversion of IRs designating the EU is not to be confused with 'Transformation', which is a legal feature introduced by the Madrid Protocol (MP) in order to soften the consequences of the five-year dependency period existing under the Madrid Agreement (see Article 6(3) MP). Transformation allows for a centrally attacked mark to be transformed into a direct CTM application but it does not allow for the conversion of an EU designation into national filings. For more information on Transformation see the Guidelines, Part M, International Marks.

2 Conversion of CTMs and IRs Designating the EU

2.1 Conversion of CTMs

Articles 112(1), 113(1), Article 159 CTMR Rule 44(1)(e), (f), Rules 122, 123 CTMIR

The applicant of a Community trade mark (CTM) application or proprietor of a registered CTM may request the conversion of its CTM application or registered CTM.

The request may be into national trade mark applications in one, more or all of the Member States, it being understood that the term ‘national applications’ or ‘national office’ includes Benelux trade mark applications or the Benelux Trade Mark Office, as far as Belgium, Luxembourg and The Netherlands are concerned.

Conversion is possible in the following circumstances (‘grounds for conversion’):

- where a CTM application has been finally refused by the Office (Article 112(1)(a) CTMR), in a decision on absolute or relative grounds for refusal during examination or opposition proceedings;
- where a CTM application has been withdrawn by the applicant (Article 112(1)(a), Article 44 CTMR);
- where a CTM application is deemed to be withdrawn, namely when class fees are not paid within the relevant time limit after filing the application (Article 112(1)(a), Article 36(5) CTMR);
- where a CTM registration ceases to have effect (Article 112(1)(b) CTMR), which applies in the following circumstances:
 - where a CTM registration has been validly surrendered (Article 50 CTMR);
 - where a CTM registration has not been renewed (Article 47 CTMR);
 - where a CTM registration has been declared invalid by the Office or by a Community trade mark court (Articles 55 and 100 CTMR);
 - where the rights of the proprietor of a CTM registration have been revoked by the Office or by a Community trade mark court (Article 55 CTMR) except in the case of revocation due to non-use (Article 112(2) CTMR).

2.2 Conversion of IRs designating the EU

The holder of an IR designating the EU may request the conversion of the designation of the EU:

- into national trade mark applications in one, more or all of the Member States;
- into subsequent designations of one or more Member States under the Madrid Agreement or Protocol (‘opting back’), provided that the Member State was a party to either Treaty not only at the point in time of the conversion request, but already on the date of the IR designating the EU;
- into national trade mark applications for some Member States and subsequent designations for other Member States, it being understood that the same Member State can only be designated once.

IR conversion is possible in the following circumstances (‘grounds for conversion’) where the designation of the EU in an IR ceases to have effect, which applies in the following circumstances:

- where the effects of an IR designating the EU have been invalidated by the Office or a CTM court (Article 158 CTMR, Rule 117 CTMIR);
- where a renunciation of the designation of the EU has been recorded in the International Register (Rule 25(1), Rule 27 CR¹);
- where a cancellation of the IR has been recorded in the International Register (Rule 25(1), Rule 27 CR): in such cases opting-back conversion is not possible; only national conversion is available where the Office is informed by WIPO that the IR has not been renewed, provided that the grace period for the renewal is over (Rule 31(4)(a) or (b) CR).
- where an IR designating the EU has been definitively refused by the Office (Rules 113(2)(b), (c), 115(5)(b), (c) CTMIR).

Conversion may be requested for all or for some of the goods or services to which the act or decision mentioned above relates.

Where the abovementioned decision or act relates only to some of the goods and services for which the application was filed or registered, conversion may be requested only for those specific goods or services, or a part of those goods or services.

3 Valid CTM Application as a Condition for Conversion

Article 112(1) CTMR

Where conversion is requested on the basis of a CTM application, conversion is possible only if there is a valid CTM application (See the Guidelines, Part B, Examination, Section 2, Formalities).

4 Grounds Precluding Conversion

Article 112(2) and Article 159 CTMR
Rules 45 and 123 CTMIR

Conversion will not take place in the following two cases: first, when a registered CTM or IR designating the EU is revoked on grounds of non-use (see paragraph 4.1 below) and, second, where the particular ground for which the CTM application or registered CTM or IR designating the EU ceasing its effects would preclude registration of the same trade mark in the Member State concerned (see paragraph 4.2 below). Therefore, a request for conversion of a rejected CTM application will not be admissible in respect of the Member State to which the grounds of refusal, invalidity or revocation apply.

¹ Common Regulations under the Madrid Agreement concerning the IR of Marks and the Protocol relating to that Agreement.

Even if the ground for conversion is the withdrawal of an application, if such a withdrawal takes place after a decision has been rendered refusing the mark on the basis of a ground that would preclude registration in the Member State concerned, such a request for conversion will be refused if no appeal has been filed.

Even if the ground for conversion is the surrender of a registration, if such a surrender takes place after a decision revoking a CTM or IR on grounds of non-use, or refusing the mark on the basis of a ground that would preclude registration in the Member State concerned has been rendered, such a request for conversion will be refused if no appeal has been filed (see paragraph 4.3 below).

4.1 Revocation on the grounds of non-use

Article 112(2)(a) CTMR

The first reason for precluding conversion is when the rights of the CTM proprietor or IR holder have been revoked on the grounds of non-use.

Conversion will not take place where the rights of the proprietor of the Community trade mark, or the holder of the IR, have been revoked on the grounds of non-use, unless in the Member State for which conversion is requested the Community trade mark has been put to use that would be considered genuine under the laws of that Member State.

No subsequent allegations by the conversion applicant regarding the substance of the case will be allowed. For instance, if the CTM was revoked for non-use, the conversion applicant cannot plead before the Office that it is able to prove use in a particular Member State.

4.2 Ground for refusal limited to a Member State or extended to the entire EU

Article 112(2)(b) CTMR
Rule 45(4) CTMIR

The second reason for precluding conversion is related to a ground for refusal, for revocation (other than for non-use) or for a declaration of invalidity. It applies when the decision of the Office or of a Community trade mark court expressly states that the ground for refusal, for revocation or for invalidity applies in respect of a particular Member State, and precludes conversion for that Member State (decision of 05/03/2009, R 1619/2008-2, orange colour mark, § 23-24).

Examples

- Where an absolute ground for refusal exists only for one language, conversion will not take place in respect of Member States where that language is an official language. For example, if an absolute ground for refusal was raised in relation to the English-speaking public, conversion would not take place in respect of the United Kingdom, Ireland and Malta (see Rule 54(4) CTMIR).

- Where an absolute ground for refusal exists only for one Member State, which may be the case because the trade mark is descriptive or deceptive only in a particular Member State and not in other Member States (see the Guidelines, Part B, Examination, Section 4, Absolute Grounds for Refusal), conversion will not take place in respect of that Member State, whereas conversion may be requested for all Member States in which the ground for refusal has not been expressly found to exist.
- Where a CTM application or IR designating the EU has been refused in an opposition based on an earlier national trade mark in a given Member State, conversion will not take place in respect of that Member State. When the opposition is based on a number of earlier rights from different Member States but the final decision rejects the CTM application or the IR designating the EU on the basis of only one of those earlier rights, conversion may be requested for the remaining Member States. For example, if in an opposition based on a UK, an Italian and a French national right, the opposition is successful insofar as it is based on the UK national right, and there is no analysis of the remaining earlier rights, conversion will not take place for the United Kingdom, but may take place for Italy and France (and all remaining Member States) (judgments of 16/09/2004, T-342/02, Moser Grupo Media, S.L., EU:T:2004:268, and 11/05/2006, T-194/05, Teletch International, EU:T:2006:124).
- According to Rule 45(4) CTMIR, applicable by analogy to IRs designating the EU in accordance with Rule 123(2) CTMIR, where a CTM application has been refused or a CTM registration has been invalidated on relative grounds based on an earlier CTM, or, in the cases of invalidation, another Community industrial property right, this has the effect of excluding conversion for the entire Union, even if likelihood of confusion exists only in part of it.

4.3 Withdrawal/surrender after a decision has been rendered

Where, in any of the above cases, the applicant withdraws the CTMA or the owner surrenders the CTM, or the holder renounces the designation of the EU before the decision becomes final (i.e. during the appeal period) and subsequently requests conversion of the mark into national trade marks in some or all of the Member States for which a ground for refusal, for revocation or invalidity applies, such a request for conversion will be refused for those Member States.

If the applicant/owner/holder files an appeal and subsequently withdraws the refused application/surrenders the invalidated/revoked CTM/designation and then requests a conversion, the withdrawal/surrender will be forwarded to the competent Board and may be put on hold pending the outcome of the appeal proceedings (judgment of 24/03/2011, C 552/09 P, TiMiKinderjoghurt, EU:C:2011:177, § 43, decisions of 22/10/2010, R 0463/2009-4, MAGENTA, § 25-27 and 07/08/2013, R 2264/2012-2, SHAKEY'S). Only once the withdrawal/surrender is processed will the conversion be forwarded as admissible to all the Member States applied for or refused, depending on the outcome of the case. (See also the Guidelines, Part D, Cancellation and Part E, Register Operations, Section 1, Changes in a Registration).

4.4 Competence to decide on grounds precluding conversion

Article 113(1) and (3) CTMR

The Office will decide whether the request for conversion fulfils the conditions set out in the Regulations in conjunction with any final decisions (their operative part and reasons) that gave rise to the conversion.

If one of the grounds precluding conversion exists, the Office will refuse to forward the conversion request to the respective national office (or, in the case of an opting-back conversion, will refuse to forward the conversion to WIPO as a subsequent designation for the Member States for which conversion is so precluded). This decision will be subject to appeal.

5 Formal Requirements for the Request of Conversion

5.1 Time limit

A general time limit of three months for requesting conversion applies. The start of the time limit depends on the ground for conversion.

The time limit may not be extended.

Furthermore, continuation of proceedings cannot be requested for this time limit, according to Article 82(2) CTMR. However, *restitutio in integrum* is, in principle, possible.

5.1.1 Start of time limit where the Office issues a notification

Article 112(4) CTMR

Where a CTM application is deemed to be withdrawn, a request for conversion may be filed within three months from the date of the corresponding confirmation from the Office.

The notification will be contained in the communication on the loss of rights.

5.1.2 Start of time limit in other cases

Article 112(5) and (6) CTMR

In all other cases the time limit of three months for requesting conversion starts automatically, namely:

- where the CTM application is withdrawn, on the day the withdrawal is received by the Office;

- where the CTM is surrendered, on the day on which the surrender is entered in the CTM Register (which is the day on which it becomes effective pursuant to Article 50(2) CTMR);
- where protection of the IR has been limited or renounced with effect for the EU, on the day as of which it has been recorded by WIPO pursuant to Rule 27(1)(b) CR;
- where the CTM registration was not renewed, on the day following the last day of the period within which a request for renewal may be submitted pursuant to Article 47(3) CTMR, i.e. six months after the last day of the month in which protection has expired;
- where the IR was not renewed with effect for the EU, on the day following the last day on which renewal may still be effected before WIPO pursuant to Article 7(4) MP;
- where the CTM application or IR designating the EU is refused, on the day on which the decision becomes final;
- where the CTM or IR designating the EU is declared invalid or revoked, on the day on which the decision of the Office or the judgment of the CTM court becomes final.

A decision of the Office becomes final:

- where no appeal is lodged, at the end of the two-month time limit for appeal pursuant to Article 60 CTMR;
- following a decision of the Boards of Appeal at the end of the time limit for appeal to the General Court, or, where applicable, with the final decision of the Court of Justice.

A decision of a CTM court becomes final:

- where no appeal is lodged, at the end of the time limit for appeal under national law;
- otherwise, with the final decision of the CTM court of final (second or third) instance.

For example, if a CTM is rejected by a decision of the Office on absolute grounds for refusal that is notified on 11/11/2011, the decision becomes final on 11/01/2012. The three-month period for requesting conversion ends on 11/04/2012.

5.2 Request for conversion

Article 113(1) CTMR Rule 83(2) CTMIR

The request for conversion will be filed at the Office. The 'Application for Conversion' form can be found on the Office's website. The use of this form is recommended.

The 'Application for Conversion of an IR designating the EC' form can be found on the Office's website. This form may also be used in the event of opting back. WIPO's MM16 form may also be used; however, the Office will send the conversion data to WIPO in electronic format and not the form itself.

Using the forms made available by the Office enables the latter to extract the relevant information concerning the converted CTM and the data concerning the applicant and representative from its database and to submit them, together with the Conversion Form, to the designated offices.

Rule 44(1) and (2) CTMIR

Applicants or their representatives may use forms of a similar structure to those made available by the Office provided that the following basic information is submitted:

- the name and address of the applicant for conversion, i.e. the applicant/proprietor of the CTM application or registration or the holder of the IR;
- the representative's name, if any;
- the filing number of the CTM application or the registration number of the CTM or the IR;
- the filing date of the CTM application or registration or, for an IR designating the EU, the date of the IR or the subsequent designation;
- particulars of any priority or seniority claim;
- the indication of the Member State or the Member States for which conversion is requested; for an IR it must also be indicated whether conversion is requested into a national application for that Member State or into a designation of the Member State under the Madrid Agreement or Protocol. As far as Belgium, the Netherlands and Luxembourg are concerned, conversion may be requested only for these three countries together, and not independently; the conversion form made available by the Office only allows for Belgium, the Netherlands and Luxembourg to be designated together; where the applicant nevertheless indicates only one of these three countries, the Office will take that as a request for conversion for Belgium, the Netherlands and Luxembourg and forward the request to the Benelux Trade Mark Office;
- the indication of the ground on which conversion is requested:
 - where conversion is requested following the withdrawal of the application, the date of withdrawal must be indicated;
 - where conversion is requested following failure to renew the registration, the date on which protection expired must be indicated;
 - where conversion is requested following the surrender of a CTM, the date on which it was entered in the Register must be indicated;

- where conversion is requested following a partial surrender, the goods/services for which the CTM no longer has protection and the date on which the partial surrender was entered in the Register must be indicated;
- where conversion is requested following a limitation, the goods/services for which the CTM application no longer has protection and the date of limitation must be indicated;
- where conversion is requested because the mark ceases to have effect as a result of a decision of a Community trade mark court, the date on which that decision became final must be indicated, and a copy of that decision, which may be in the language in which the decision was given, must be supplied;
- where conversion is requested because an IR designating the EU has been finally refused by the Office, the date of the decision must be indicated;
- where conversion is requested because the effects of an IR designating the EU have been invalidated by the Office or by a CTM Court, the date of the decision of the Office or the date on which the judgment of the CTM Court became final must be indicated together with a copy of the judgment attached;
- where conversion is requested because the designation of the EU has been renounced or cancelled before WIPO, the date on which it has been recorded by WIPO must be indicated;
- where conversion is requested because the IR designating the EU has not been renewed, and provided that the grace period for the renewal is over, the date of expiry of protection must be indicated.

The request for conversion may contain:

- an indication that it relates only to a part of the goods and services for which the application was filed or registered, in which case the goods and services for which conversion is requested must be indicated;
- an indication that conversion is requested for different goods and services with respect to different Member States, in which case the respective goods and services must be indicated for each Member State.

The request for conversion may also contain an appointment of a representative before a designated national office, by ticking the relevant boxes in the Annex to the Conversion Form. This indication is voluntary and not of relevance for the conversion procedure before the Office but will be useful for the national offices once they receive the conversion request, so that they can immediately communicate with a representative who is authorised to practise before that national office (see paragraph 6 below).

5.3 Language

Rule 95(a), Rule 126 CTMIR

Where the request for conversion is made in respect of a CTM application, it must be filed in the language in which the CTM application was filed or in the second language indicated therein.

Where the request for conversion is made in respect of an IR designating the EU before the point in time when a statement of grant of protection was issued pursuant to Rule 116 CTMIR, the request must be filed in the language in which the international application was filed with WIPO or in the second language indicated therein.

Rule 95(b), Rule 126 CTMIR

Where the request is made in respect of a CTM registration, it may be filed in any of the five languages of the Office.

Where the request for conversion is made in respect of an IR designating the EU after a statement of grant of protection has been issued, the request may be filed in any of the five languages of the Office, except in the case of an 'opting-back' conversion, when the request must be filed in English, French or Spanish.

However, when the request for conversion is filed by using the form provided by the Office pursuant to Rule 83 CTMIR, the form may be used in any of the official languages of the Community, provided that the form is completed in one of the languages of the Office as far as textual elements are concerned. This concerns, in particular, the list of goods and services in the event of a request for partial conversion.

5.4 Fee

Article 113(1) CTMR
Rule 45(2) CTMIR
Articles 2(20) and 8(3) CTMFR

The request for conversion is subject to payment of a fee of EUR 200, including for conversion of an IR designating the EU. The request will not be deemed to be filed until the conversion fee has been paid. This means that the conversion fee has to be paid within the abovementioned time limit of three months. A payment made after the expiry of the period will be considered to have been made in due time if the person concerned submits evidence that, in a Member State and within the period of three months, the payment had been made to a bank or a transfer order placed, and if at the same time of payment a surcharge of ten per cent of the total amount due was paid (see the Guidelines, Part A, General Rules, Section 3, Payment of Fees, Costs and Charges).

6 Examination by the Office

6.1 Stages of the procedure, competence

The Office will deal with requests for conversion by:

Article 113(2) and (3) CTMR

Rules 45-47 CTMIR

- examining them;
- publishing them; and
- submitting them to the designated offices.

6.2 Examination

The examination of the request for conversion by the Office relates to the following points:

- fees;
- time limit;
- language;
- formalities;
- grounds;
- representation;
- partial conversion.

6.2.1 Fees

Rules 45(2) and 122(3) CTMIR

The Office will examine whether the conversion fee has been paid within the applicable time limit.

Where the conversion fee has not been paid within the applicable time limit, the Office will inform the applicant that the application for conversion will be deemed not to have been filed. Any fees paid late will be reimbursed.

6.2.2 Time limit

Rules 45(1) and 122(3) CTMIR

The Office will examine whether the request has been filed within the time limit of three months.

The Office will reject the request for conversion where the request was not filed within the relevant time limit of three months. Any fees paid late will not be reimbursed.

6.2.3 Language

Rule 95(a), Rule 126 CTMIR

The Office will examine whether the request has been filed in the correct language.

When the request is filed in a language which is not one of the acceptable languages for the conversion procedure (see paragraph 5.3 above), the Office will send a deficiency letter to the applicant and specify a period within which it may amend the application for conversion. If the applicant fails to respond, the request will not be dealt with and will be considered not to have been filed. Any fees paid will not be reimbursed.

6.2.4 Formalities

Rule 44(1)(b), (d) and (e) CTMIR

The Office will examine whether the request complies with the formal requirements of the Implementing Regulation (see paragraph 5 above).

Where the conversion applicant has not used the Conversion Form made available by the Office and where the deficiency lies in not having indicated the elements referred to in Rule 44(1)(b), (d) or (e) CTMIR, the conversion applicant will be invited to either submit the missing indications or, where such indications may be readily ascertained from data available to the Office, will be considered as having authorised the Office to make available to the designated offices the relevant extracts from its database.

6.2.5 Grounds

The Office will examine:

- whether one of the grounds for conversion mentioned in paragraph 2 above exists;
- whether one of the grounds precluding conversion referred to in paragraph 4 above exists;

Rule 123(2) CTMIR

- for an opting-back conversion, whether it would have been possible at the date of the IR to designate the Member State concerned in an international application;
- for partial conversion, whether the goods and services to be converted were in fact contained in, and do not go beyond, the goods and services of the CTM or IR designating the EU at the point in time when it lapsed or ceased to have effect (see paragraph 6.3 below);
- for partial conversion in the sense that part of the CTM or IR designating the EU remains alive, whether the goods and services to be converted overlap with the goods and services for which the mark remains alive (see paragraph 6.3 below).

The aim of these last two examination steps is to avoid conversion for more or broader goods and services than have been refused or cancelled.

When the request for conversion does not comply with any of the other mandatory elements and indications referred to in paragraphs 4 and 5.2 above, the Office will send a deficiency letter to the applicant and specify a period within which it may amend the application for conversion. If the applicant fails to respond, the request will not be dealt with and will be considered not to have been filed. Any fees paid will not be reimbursed.

6.2.6 Representation

Rule 76(1)-(4) CTMIR

The general rules on representation apply (see the Guidelines, Part A, General Rules, Section 5, Professional Representation). The person requesting conversion may appoint a new or an additional representative (legal practitioner or Office professional representative) for the conversion procedure.

Any authorisation to act on behalf of the applicant or proprietor extends only to acts before the Office. Whether a representative appointed for proceedings before the Office may act before the national office in respect of the resulting national application and, if so, whether they need to present an additional authorisation, is determined by the national law concerned. In the event of an opting-back conversion, the name of the representative appointed before the Office will be submitted to WIPO.

6.2.7 Partial conversion

Article 112(1) CTMR Rule 44(1)(e) CTMIR
--

Where conversion is requested only for some of the goods and services, or for different goods and services for different Member States ('partial conversion'), the Office will examine whether the goods and services for which conversion is requested are contained within the goods and services for which the ground of conversion applies. For this assessment the same criteria apply as in similar procedural situations, such as restriction of an application or partial refusal in an opposition proceeding.

Where an application is refused in part or a registration is invalidated or revoked in part, conversion may be requested only for the goods or services for which the application was refused or the registration was invalidated or revoked, and not for the goods or services for which the application or registration remains valid.

Where an application is limited, or a registration is partially surrendered, conversion may be requested only for the limited/partially surrendered goods or services, and not for the goods or services for which the application or registration remains valid. However, please refer to paragraph 4.3 above when such a limitation/partial surrender takes place following a decision.

The applicant must indicate in the abovementioned cases the goods and services for which conversion is requested. Expressing the limitation in a negative way, such as by using expressions of the type 'beverages with the exception of ...', is admissible in the same way that such an expression is admissible when filing or restricting a CTM

application or partially surrendering a CTM registration (see the Guidelines, Part B, Examination, Section 3, Classification).

6.3 Publication of the request and entry in the Register

Article 113(2) CTMR
Rule 84(3)(p) CTMIR

Upon acceptance of a request for conversion that is deemed to have been filed because the required fee has been paid, the Office will make an entry in the Register of Community Trade Marks recording the receipt of the request for conversion, provided that the request for conversion is of a published CTMA or a registered CTM.

Article 113(2) CTMR
Rule 46(1) CTMIR

After having examined the request for conversion and having found it in order, the Office will register and publish the request for conversion in the Community Trade Marks Bulletin in Part E.1. for CTMs and Part E.3. for IRs designating the EC. However, no such publication will be made when the request for conversion is submitted at a time when the CTM application has not already been published in accordance with Article 39 CTMR.

Rule 46 CTMIR

The request for conversion is published only after the Office has completed examination of it and found it to be in order. The request is not in order if there is no payment.

Rule 46(2) CTMIR

The publication of the application for conversion must contain the indications referred to in Rule 46(2) CTMIR and, unless it concerns an IR designating the EC, include a reference to the previous publication in the Community Trade Marks Bulletin and the date of the application for conversion.

Rule 46(2), Rules 122 and 123 CTMIR

Lists of goods and services for which conversion is requested will not be published if the conversion is for an IR designating the EC.

6.4 Submission to designated offices

Articles 113(3) and 114(1) CTMR
Rule 47 CTMIR

Once the Office has completed examination of the request for conversion and has found it to be in order, it will submit the request without delay to the designated offices.

The submission will be made irrespective of whether any required publication has already taken place.

The Office will send a copy of the request for conversion and make available an extract of its database containing the data referred to in Rule 84(2) CTMIR of the converted CTM or IR. Any central industrial property office to which the request for conversion is submitted may obtain from the Office any additional information concerning the request, enabling that office to make a decision regarding the national trade mark resulting from the conversion.

Rule 47 CTMIR

At the same time, the Office will inform the conversion applicant of the date of submission to national offices.

In the case of an opting-back conversion, WIPO will deal with the request as a subsequent designation in accordance with Rule 24(6), (7) CR.

If a national office is the designated office, conversion will result in a national application or registration.

Article 114(3) CTMR

The national law in force for the Member States concerned may provide that the request for conversion be subject to one, or all, of the following requirements:

- payment of a national application fee;
- filing of a translation in one of the official languages of the Member State in respect of the request and its accompanying documents; in particular, for applications for conversion prior to publication of the CTM, the national office will usually require a translation of the list of goods and services;
- indication of an address for service in the Member State in question;
- submission of a representation of the mark in a number of copies specified by that Member State.

National rules on the appointment of a domestic representative remain applicable. Where use is made of the option to indicate, in the Conversion Form, a representative for the purposes of the procedure before a given national office, that national office will be in a position to communicate directly with that representative so that no separate communication to appoint a domestic representative will be necessary.

Article 114(2) CTMR

National law may not subject the request for conversion to any formal requirements different from or additional to the requirements provided for in the CTMR and CTMIR.

7 Effects of Conversion

Article 112(3) CTMR

In each Member State concerned, the national trade mark application resulting from the conversion will enjoy the filing date or, if any, the priority date of the CTM application, as well as the seniority of an earlier trade mark with effect for that State validly claimed for the CTM application or registration under Article 34 or 35 CTMR. For information on conversion of a CTM into national trade mark applications for new Member States see the Guidelines, Part A, General Rules, Section 9, Enlargement.

In the event of an opting-back conversion, the international application resulting from the subsequent designation of the Member State under Rule 24(6)(e), (7) CR will enjoy the original date of the IR designating the EC, that is, either the actual date of the IR (including, if appropriate, its priority date) or the date of the subsequent designation of the EC.

However, there is no harmonised procedure for how national offices will proceed with the examination of the converted CTM. As mentioned in the introduction, the conversion procedure is a two-tier system, where the second tier, the conversion procedure itself, is dealt with by the national trade mark and patent offices. Depending on national law, the converted trade mark will either be registered immediately or will enter the national examination, registration and opposition procedure like any other national trade mark application.

National applications deriving from the conversion of an earlier CTM(A) are considered to come into existence as soon as a valid conversion request is filed. Therefore, in opposition proceedings, such rights will be considered properly identified for admissibility purposes under Rule 18(1) CTMIR if the opponent indicates the number of the CTM(A) under conversion and the countries for which it has requested conversion.

When, during opposition or invalidity proceedings on relative grounds, the CTM application (or CTM) on which the opposition is based ceases to exist (or the list of goods and services is restricted), but at the same time a request for conversion is filed, the opposition or invalidity proceedings can continue. This is because national trade mark registrations resulting from a conversion of a CTM application (or CTM) can constitute the basis of the opposition or invalidity procedure originally made on the basis of that CTM application or registration (see decision of the Grand Board of Appeal in R 1313/2006-G) (see also the Guidelines, Part C, Opposition, Section 1, Procedural Matters).

***GUIDELINES FOR EXAMINATION IN THE
OFFICE FOR HARMONIZATION IN THE
INTERNAL MARKET (TRADE MARKS AND
DESIGNS) ON COMMUNITY TRADE MARKS***

PART E

REGISTER OPERATIONS

SECTION 4

RENEWAL

Table of Contents

1	Fraud Warning	4
	1.1 Private companies sending misleading invoices	4
	1.2 Renewal by unauthorised third persons	4
2	Terms of Registration.....	4
3	Notification of Expiry of Registration	4
4	Renewal of a CTM Application	5
5	Fees and Other Formal Requirements for the Request for Renewal	5
	5.1 Persons who may submit a request for renewal	6
	5.2 Content of the request for renewal.....	6
	5.2.1 Name and address and other particulars of the person submitting a request for renewal	7
	5.2.1.1 Request filed by the proprietor of the Community trade mark	7
	5.2.1.2 Request filed by a person authorised to do so by the proprietor	7
	5.2.2 Registration number of the Community trade mark.....	7
	5.2.3 Indication as to the extent of the renewal	7
	5.3 Languages	8
	5.4 Time limit	8
	5.4.1 Six month period for renewal before expiry (basic period)	8
	5.4.2 Six month grace period following expiry (grace period)	8
	5.5 Fees	9
	5.5.1 Fees payable	9
	5.5.2 Time limit for payment	9
	5.5.3 Payment by third parties	10
	5.5.4 Fee refund	10
6	Procedure Before the Office	11
	6.1 Examination of formal requirements.....	11
	6.1.1 Observation of time limits	11
	6.1.1.1 Payment during the basic period or the grace period	11
	6.1.1.2 Payment after the expiry of the grace period.....	12
	6.1.1.3 Situation where the proprietor holds a current account	12
	6.1.1.4 Continuation of proceedings.....	13
	6.1.1.5 Restitutio in integrum.....	13
	6.1.2 Compliance with formal requirements of the Implementing Regulation	13
	6.1.2.1 Renewal requested by authorised person	13
	6.1.2.2 Further requirements	14
	6.2 Items not to be examined.....	15
	6.3 Alteration	15
7	Entries in the Register.....	15
8	Date of Effect of Renewal or Expiry, Conversion	16

8.1	Date of effect of renewal	16
8.2	Conversion of lapsed CTMs	16
9	Renewal of International Marks Designating the EU	17

1 Fraud Warning

1.1 Private companies sending misleading invoices

The Office is aware that users in Europe are receiving an increasing amount of unsolicited mail from companies requesting payment for trade mark and design services such as renewal.

A list of letters from firms or registers, which users have complained are misleading, is published on the Office website. These services are not connected with any official trade mark or design registration services provided by IP Offices or other public bodies within the European Union such as OHIM.

If a user receives a letter or invoice, he or she should carefully check what is being offered, and its source. It must be pointed out that **OHIM never sends invoices to users or letters requesting direct payment for services** (see the Guidelines, Part A, General Rules, Section 3, Payment of Fees, Costs and Charges).

1.2 Renewal by unauthorised third persons

The Office is also aware that fraudsters have targeted the e-Renewal module applying for renewal without the consent of the proprietor and thus blocking renewal via the module for persons legitimately authorised to do so. This technical block is designed to prevent a renewal being paid for twice. If, upon filing a request for e-Renewal a user discovers that the mark is 'blocked', as renewal has already been requested for the mark, they should contact the Office.

2 Terms of Registration

Article 46 CTMR Articles 26, 27 CTMR Rule 9 CTMIR

The term of registration of a Community trade mark (CTM) is ten years from the filing date of the application. For example, a CTM with a filing date of 16 April 2006 will expire on 16 April 2016.

The filing date of the application is determined according to Articles 26, 27 CTMR and Rule 9 CTMIR.

Registration may be renewed indefinitely for further periods of 10 years.

3 Notification of Expiry of Registration

Article 47(2) CTMR Rule 29 CTMIR Communication No 5/05 of the President of the Office of 27 July 2005

At least six months before the expiry of the registration, the Office will inform:

- the registered proprietor of the Community trade mark and
- any person having a registered right in respect of the Community trade mark

that the registration is approaching expiry. Persons having a registered right include the holders of a registered licence, the proprietors of a registered right *in rem*, the creditors of a registered levy of execution or the authority competent to act on behalf of the proprietor in insolvency procedures.

Failure to give such information does not affect the expiry of the registration and does not involve the responsibility of the Office.

4 Renewal of a CTM Application

Communications No 5/05 and 8/05 of the President of the Office of 27 July 2005 and 21 December 2005
Article 2(16) CTMFR

In the exceptional circumstance where an application has not yet matured to registration because of pending proceedings, the Office will not send the notice referred to in Article 47(2) CTMR. The applicant is not obliged to renew its application during proceedings that last for more than 10 years and where the outcome of registration is uncertain. Only once the trade mark is registered will the Office invite the owner to renew the CTM and pay the renewal fee (retroactively). The owner will then have two months to pay the renewal fee (including any additional class fees). If the renewal fee is not paid within this first time limit, the owner will be given a second time limit of two additional months (a total of four months from the date of the first letter) in which to pay the renewal fee. During this further time limit of two months, the surcharge for the renewal fee of 25 % pursuant to Article 2(16) CTMFR does not apply. If the renewal fee is not paid within the additional time limit given, the Office will issue a notice that the registration has expired.

5 Fees and Other Formal Requirements for the Request for Renewal

Rules 79, 80, 82 CTMIR
Communication No 8/05 of the President of the Office of 21 December 2005 concerning the renewal of Community trade marks

The general rules concerning communications to the Office apply (see the Guidelines, Part A, General Rules, Section 1, Means of Communication, Time Limits), which means that the request may be submitted as follows:

- by electronic means available on the OHIM Website (e-renewal). There is a reduction of 10 % of the renewal basic fee in case of e-renewal. Entering the name and surname in the appropriate place on the electronic form is deemed to be a signature. In addition to the fee reduction, using e-renewal offers additional advantages such as the receipt of immediate electronic confirmation of the renewal request automatically or the use of the renewal manager feature to complete the form quickly for as many CTMs as needed.

- by transmitting a signed original form by fax, mail, or any other means (see the Guidelines, Part A, General Rules, Section 1, Means of Communication, Time Limits). A standard form is available on OHIM's website. Forms have to be signed but annexes need not be.

5.1 Persons who may submit a request for renewal

Articles 17(7), 47(1) CTMR Communication No 8/05 of the President of the Office of 21 December 2005 concerning the renewal of CTMs

The request for renewal may be submitted by:

- a) the registered proprietor of the Community trade mark;
- b) where the CTM registration has been transferred, the successor in title as from the point in time a request for registration of the transfer has been received by the Office;
- c) any person expressly authorised by the proprietor of the Community trade mark to do so. Such a person may, for instance, be a registered licensee, a non-registered licensee or any other person who has obtained the authorisation of the CTM proprietor to renew the mark.

An authorisation will have to exist in its favour; however, it does not need to be filed with the Office unless the Office requests it (see paragraph 6.1.2.1 below). If the Office receives fees from two different sources, neither of which is the owner or its representative on file, the owner will be contacted in order to know which person is authorised to file the renewal request. Where no reply is received from the owner, the Office will validate the payment that reached the Office first (judgment of 12/05/2009, T-410/07, Jurado, EU:T:2009:153, § 33-35 and decision of 13/01/2008, R 0989/2007-4 Elite glass-seal, § 17-18).

Representation pursuant to Article 92(2) CTMR is not mandatory for renewal.

5.2 Content of the request for renewal

Article 47(1) CTMR Rule 30(1) and (3) CTMIR
--

The request for renewal must contain the following: name and address of the person requesting the renewal and the registration number of the renewed CTM. The extent of the renewal is deemed total by default.

Payment alone can constitute a valid request for renewal providing such payment reaches the Office and contains the name of the payer, the registration number of the CTM and the indication 'renew'. In such circumstances no further formalities need be complied with (see the Guidelines, Part A, General Rules, Section 3, *Payment of Fees, Costs and Charges*).

5.2.1 Name and address and other particulars of the person submitting a request for renewal

5.2.1.1 Request filed by the proprietor of the Community trade mark

Where the request is filed by the CTM proprietor, its name must be indicated.

If the Office has attributed an ID number to the proprietor, this number should be indicated together with the name.

5.2.1.2 Request filed by a person authorised to do so by the proprietor

Rules 1(1)(b) and (e) CTMIR

Where the request for renewal is filed by a person authorised by the proprietor to do so, the name and address or the ID number and name of the authorised person in accordance with Rule 1(1)(b) CTMIR must be indicated.

If the selected payment method is Bank Transfer a copy of the renewal request is sent to the proprietor.

5.2.2 Registration number of the Community trade mark

Rule 30(1)(b) CTMIR

The registration number of the Community trade mark must be indicated.

5.2.3 Indication as to the extent of the renewal

Rule 30(1)(c) CTMIR

Where renewal is total, i.e. it is requested for all the goods and services for which the mark is registered, an indication to that effect is required; if nothing is indicated, the renewal is deemed to be total by default.

Where renewal is requested for only some of the goods or services for which the mark is registered:

- an indication of those classes or those goods and services for which renewal is requested in a clear and unequivocal way. E-renewal only allows for deleting whole classes and not only part of the class.

Or, alternatively,

- an indication of those classes or those goods and services for which renewal is not requested in a clear and unequivocal way (this is only possible when filed on the paper form).

5.3 Languages

Rule 95(b) CTMIR

The request for renewal may be filed in any of the five languages of the Office. This language becomes the language of the renewal proceedings. However, when the request for renewal is filed by using the form provided by the Office pursuant to Rule 83, such a form may be used in any of the official languages of the Community, provided that the form is completed in one of the languages of the Office, as far as textual elements are concerned. This concerns, in particular, the list of goods and services in the event of a partial renewal.

5.4 Time limit

Article 46 and Article 47(3) CTMR Rule 72(1) CTMIR

5.4.1 Six month period for renewal before expiry (basic period)

The request for renewal and the renewal fee must be submitted within a period of six months ending on the last day of the month in which protection ends.

For example, where the Community trade mark has a filing date of 1 April 2006, the last day of the month in which protection ends will be 30 April 2016. Therefore, a request for renewal must be introduced and the renewal fee paid as from 1 November 2015 until 30 April 2016 or, where this is a Saturday, Sunday or other day on which the Office is closed, or does not receive ordinary mail within the meaning of Rule 72(1) CTMIR, the first following working day on which the Office is open to the public and receives ordinary mail.

5.4.2 Six month grace period following expiry (grace period)

Where the Community trade mark is not renewed within the basic period, the request may still be submitted and the renewal fee may still be paid, upon payment of an additional fee (see paragraph 5.5 below), within a further period of six months following the last day of the month in which protection ends.

For example, where the Community trade mark has a filing date of 1 April 2006, the last day of the month in which protection ends will be 30 April 2016. Therefore, the grace period during which a request for renewal may still be introduced upon payment of the renewal fee plus the additional fee is counted from the day after 30 April 2016, namely from 1 May 2016, and ends on 31 October 2016 or, if 31 October 2016 is a Saturday, Sunday or other day on which the Office is closed, or does not receive ordinary mail within the meaning of Rule 72(1) CTMIR, the first following working day on which the Office is open to the public and receives ordinary mail. This also applies if in the above example 30 April 2016 was a Saturday or Sunday; the rule that a time limit to be observed vis-à-vis the Office is extended until the next working day applies only once and to the end of the basic period, and not to the starting date of the grace period.

5.5 Fees

5.5.1 Fees payable

Article 47(3) CTMR
Rule 30(2)(a) and (b) CTMIR
Article 2(12), (12a), (13), (14) and (15) CTMFR

The fees payable for the renewal of a Community trade mark consist of a basic fee and class fees for each class of goods and services exceeding three of the classes contained in the CTM for which renewal is applied for.

The basic fee is

- for an individual mark: EUR 1 500/EUR 1 350 in case of e-renewal and
- for a collective mark: EUR 3 000.

The class fee for each additional class exceeding three is:

- for an individual mark: EUR 400
- for a collective mark: EUR 800.

5.5.2 Time limit for payment

The fee must be paid within a period of six months ending on the last day of the month in which protection ends (for calculation of the period, see the example given in paragraph 5.4.1 above).

Article 47(3) CTMR
Rule 30(2)(c) and Rule 30(4) CTMIR
Articles 2(16) and 8(3) CTMFR

The fee may be paid within a further period of six months following the last day of the month in which protection ends (see paragraph 5.4.2 above), provided that an additional fee is paid, which amounts to 25 % of the total renewal fee, including any class fees, but which is subject to a maximum of EUR 1 500.

Renewal will be effected only if payment of all fees (renewal fees and additional fees for late payment, where applicable) reaches the Office within the grace period (see paragraph 5.4.2 above).

Fees which are paid before the start of the first six-month period will not, in principle, be taken into consideration and will be refunded.

Rule 72(1) CTMIR

Where the CTM proprietor has a current account at the Office, the renewal fee will only be debited once a request for renewal is filed and the renewal fee (including any class

fees) will be debited on the last day of the time limit of six months provided for in Article 47(3) CTMR, i.e. on the last day of the month in which protection ends, unless other instructions are given.

Article 7(1)(d) of Decision No EX-96-1 of the President of the Office of 11 January 1996 concerning the conditions for opening current accounts at the Office, as amended by Decision No EX-03-1 of 20 January 2003 and by Decision No EX-06-1 of 12 January 2006

In the event of the belated filing of a request for renewal (see paragraph 5.4.2 above), and where the CTM proprietor has a current account at the Office, the renewal fee and surcharge will be debited on the last day of the further period of six months provided for in Article 47(3) CTMR, third sentence, i.e. on the last day of the further period of six months following the last day of the month in which protection ends, unless other instructions are given.

5.5.3 Payment by third parties

Payment may also be made by the other persons identified in paragraph 5.1 above.

Payment by debiting a current account held by a third party requires an explicit authorisation of the holder of the current account that the account can be debited for the benefit of the particular fee. In such cases the Office will check if there is an authorisation. If there is no authorisation, a letter will be sent to the renewal applicant asking them to submit the authorisation to debit the account held by a third party. In such cases, payment is considered to be effected on the date the Office receives the authorisation.

5.5.4 Fee refund

Rule 30(6) and (7) CTMIR

Renewal fees and, where applicable, the additional fee for late payment may be refunded under certain circumstances. For full information, please see the Guidelines, Part A, General Rules, Section 3, Payment of Fees, Costs and Charges.

6 Procedure Before the Office

6.1 Examination of formal requirements

The examination of the request for renewal is limited to formalities and relates to the following points:

6.1.1 Observation of time limits

Article 47(3) and (4) CTMR Rule 30(2), (3) CTMIR

6.1.1.1 Payment during the basic period or the grace period

Where the request for renewal is filed and the renewal fee is paid within the basic period, the Office will record the renewal, provided that the other conditions laid down in the CTMR and CTMIR are fulfilled (see paragraph 6.1.2 below).

Article 47(3) CTMR Communication No 8/05 of the President of 21 December 2005
--

Where no request for renewal has been filed, but a payment of the renewal fee reaches the Office that contains the minimum indications (name and address of the person requesting the renewal and the registration number of the renewed CTM), this constitutes a valid request and no further formalities need be complied with.

However, where no request for renewal has been filed but a renewal fee has been paid that does not contain the minimum indications (name and address of the person requesting the renewal and the registration number of the renewed CTM), the Office will invite the CTM proprietor to submit a request for renewal and pay, where applicable, the additional fee for late submission of the request for renewal. A letter will be sent out as early as is reasonably possible after receipt of the fee, so as to enable filing of the request before the additional fee becomes due.

Where a request has been submitted within the basic period, but the renewal fee has not been paid or has not been paid in full the Office will invite the person requesting renewal to pay the renewal fee or the remaining part thereof and the additional fee for late payment. In the case of incomplete payment of the fee, the CTM proprietor may, instead of paying the missing amount, restrict its request for renewal to the corresponding number of classes.

If the request for renewal is filed by a person authorised by the proprietor of the CTM (according to point 5.1c), the proprietor of the CTM will receive a copy of the notification.

6.1.1.2 Payment after the expiry of the grace period

Article 47(3) CTMR, Rule 30(5) and Rule 54 CTMIR
--

Where a request for renewal has not been submitted or is submitted only after the expiry of the grace period, the Office will determine that the registration has expired and will issue a notification on loss of rights to the proprietor and any person recorded in the Register as having rights in the mark.

Where the fees are not paid or are paid only after expiry of the grace period, the Office will determine that the registration has expired and will issue a notification on loss of rights to the proprietor and any person recorded in the Register as having rights in the mark.

Where the fee paid amounts to less than the basic fee and the fee for late payment/late submission of the request for renewal, the Office will determine that the registration has expired and will issue a notification on loss of rights to the proprietor and any person recorded in the Register as having rights in the mark.

Where the fee paid covers the basic fee and the fee for late payment, but not all class fees, the Office will only renew the registration for some classes. The determination of which classes of goods and services are to be renewed will be made according to the following criteria.

- Where the request for renewal is expressly limited to particular classes, only those classes will be renewed.
- Where it is otherwise clear from the request which class or classes are to be covered by the request, that class or those classes will be renewed.
- The Office may contact the proprietor to ask for the class preferences in the event of partial payment.
- In the absence of other criteria, the Office will take the classes into account in the numerical order of classification, beginning with the class having the lowest number.

Where not all class fees are paid and the Office determines that the registration has expired for some of the classes of goods or services, it will issue, together with the renewal confirmation, a notification of loss of rights for those classes of goods or services to the proprietor and, where appropriate, the person requesting renewal and the person recorded in the Register as having rights in the mark. If the person concerned finds that the finding of the Office is inaccurate, they may, within two months of the notification of the loss of rights, apply for a decision on the matter.

6.1.1.3 Situation where the proprietor holds a current account

The Office will not debit a current account unless there is an express request for renewal. It will debit the account of the person who has acted (CTM proprietor or third person).

Where the request is filed within the basic period, the Office will debit the renewal fees (basic renewal fee plus applicable class fees) without surcharge.

Where the request is filed within the grace period, the Office will debit the renewal fee plus the 25 % surcharge (see paragraph 5.5 above).

6.1.1.4 Continuation of proceedings

Article 82(2) CTMR
Communication No°6/05 of the President of the Office of 16/09/2005.

The time limit for requesting renewal is specifically excluded from continuation of proceedings.

6.1.1.5 Restitutio in integrum

Article 81 CTMR
Article 67 CDR

Restitutio in integrum is available for the time limit for requesting renewal. For more information see the Guidelines, Part A, General Rules, Section 8, Restitutio in Integrum.

The incorrect functioning of renewal software is normally not a reason to justify restitutio in integrum (judgments of 13/05/2009, T-136/08, Aurelia, EU:T:2009:155; 19/09/2012, T-267/11, VR, EU:T:2012:1249, 28/06/2012, T-314/10, Cook's, EU:T:2012:329).

In the case of failure to submit a request for renewal or to pay the renewal fee, the time limit of one year starts on the day on which the protection ends, and not on the date of expiry of the grace period of six months.

6.1.2 Compliance with formal requirements of the Implementing Regulation

6.1.2.1 Renewal requested by authorised person

Communication No 8/05 of the President of the Office, 21 December 2005

Where a renewal request is filed on behalf of the trade mark proprietor there is no need to file an authorisation. However, such an authorisation should exist in favour of the person filing the request should the Office request it.

6.1.2.2 Further requirements

Rule 30(1)(b), Rule 30(4) CTMIR

Where the request for renewal does not comply with other formal requirements, namely where the name and address of the person requesting renewal has not been sufficiently indicated, where the registration number has not been indicated, where it has not been properly signed or, if partial renewal was requested but the goods and services to be renewed have not been properly indicated, the Office will invite the person requesting renewal to remedy the deficiencies within a time limit of two months. The time limit applies even if the grace period has already expired.

The Office will consider the request to be made for the renewal for all goods and services unless partial renewal is expressly requested. In the event of a partial renewal, please refer to paragraph 5.2.3 above.

If the request for renewal is filed by a person authorised by the proprietor of the CTM (according to point 5.1.c), the proprietor of the CTM will receive a copy of the notification.

Where a request for renewal has been submitted by two different persons claiming to be authorised by the proprietor of the CTM ('authorised person'), the Office will seek clarification on who the authorised person is by contacting the owner directly.

Rule 30(5), Rule 54 CTMIR

Where these deficiencies are not remedied before the expiry of the relevant time limit, the Office will proceed as follows.

- If the deficiency consists of failing to indicate the goods and services of the CTM to be renewed, the Office will renew the registration for all the classes for which the fees have been paid, and if the fees paid do not cover all the classes of the CTM registration, the determination of which classes are to be renewed will be made according to the criteria set out in paragraph 6.1.1.2 above. The Office will issue, together with the renewal confirmation, a notification of loss of rights for those classes of goods or services the Office deems expired, to the proprietor and any person recorded in the Register as having rights in the mark.
- If the deficiency consists of the Owner's failure to respond to a request for clarification on who the authorised person is, the Office will accept the request for renewal filed by the authorised representative on file. If neither of the requests for renewal has been filed by an authorised representative on file, the Office will accept the renewal request that was first received by the Office.
- In the case of the other deficiencies, it will determine that the registration has expired and will issue a notification of loss of rights to the proprietor or, where applicable, the person requesting renewal and any person recorded in the Register as having rights in the mark.

6.2 Items not to be examined

No examination will be carried out on renewal for the registrability of the mark, nor will any examination be carried out as to whether the mark has been put to genuine use.

No examination will be carried out by the Office on renewal as to the correct classification of the mark, nor will a registration be reclassified that has been registered in accordance with an edition of the Nice Classification that is no longer in force at the point in time of renewal. All of this is without prejudice to the application of Article 50 CTMR.

6.3 Alteration

Article 48 CTMR

The Community trade mark will not be altered in the Register on renewal. Since renewal is considered a simple prolongation of the period of protection of the CTM upon payment of the necessary fees, it may not include changes in relation to the representation of the mark in its latest form, that is, at the expiry of the current period of protection.

Any other changes that do not alter the mark itself (changes of name, of address, etc.) that the owner wishes to have recorded in the Register when the registration is renewed must be communicated separately to the Office according to the applicable procedures (see the Guidelines, Part E, Register Operations, Section 1, Changes in a Registration). They will be included in the data recorded at renewal only if they are recorded in the CTM Register no later than the date of expiry of the CTM registration.

7 Entries in the Register

Article 47(5) CTMR
Rule 84(3)(k), Rule 84(5) CTMIR

Where the request for renewal complies with all the requirements, the renewal will be registered.

The Office will notify the CTM proprietor of the renewal of the CTM registration and its entry in the Register. The renewal will take effect from the day following the date on which the existing registration expires (see paragraph 8 below).

Where renewal has taken place only for some of the goods and services contained in the registration, the Office will notify the proprietor and any person recorded in the Register as having rights in the mark of the goods and services for which the registration has been renewed and the entry of the renewal in the Register and of the date from which renewal takes effect (see paragraph 8 below). Simultaneously, the Office will notify the expiry of the registration for the remaining goods and services and of their cancellation from the Register.

Rules 30(5) and (6), Rule 54(2) CTMIR

Where the Office has made a determination pursuant to Rule 30(6) CTMIR that the registration has expired, the Office will cancel the mark from the Register and notify the proprietor accordingly. The proprietor may apply for a decision on the matter under Rule 54(2) CTMIR within two months.

Rule 84(3)(l), Rule 84(5) CTMIR

The Office will inform the proprietor and any person recorded in the Register as having rights in the mark of the expiry of the registration and its cancellation from the Register.

8 Date of Effect of Renewal or Expiry, Conversion

8.1 Date of effect of renewal

Article 47(5) CTMR
Rules 70(3) and 30(6) CTMIR

Renewal will take effect from the day following the date on which the existing registration expires.

For example, where the filing date of the registration is 1 April 2006, the registration will expire on 1 April 2016. Therefore, renewal takes effect from the day following 1 April 2016, namely 2 April 2016. Its new term of registration is ten years from this date, which will end on 1 April 2026. It is immaterial whether any of these days is a Saturday, Sunday or official holiday. Even in cases where the renewal fee is paid within the grace period, the renewal takes effect from the day following the date on which the existing registration expires.

Where the mark has expired and is removed from the Register, the cancellation will take effect from the day following the date on which the existing registration expired.

For example, where the filing date of the registration is 1 April 2006, the registration will expire on 1 April 2016. Therefore, the removal from the Register takes effect from the day following 1 April 2016, namely 2 April 2016.

8.2 Conversion of lapsed CTMs

Articles 47(3) and 112(5) CTMR

Where the owner wants to convert its lapsed CTM into national marks, the request must be filed within three months from the day following the last day of the period within which a request for renewal may be presented pursuant to Article 47(3) CTMR, i.e. six months after the last day of the month in which protection has expired. The time limit of three months for requesting conversion starts automatically without notification (see the Guidelines, Part E, Register Operations, Section 2, Conversion).

9 Renewal of International Marks Designating the EU

Article 159(1) CTMR
Rule 107 CTMIR

The principle is that any changes relating to the international registration will be filed directly at WIPO by the holder of the international registration. The Office will not deal with renewal requests or payment of renewal fees.

The procedure for renewal of international marks is managed entirely by the International Bureau. The International Bureau will send notice for renewal, receive the renewal fees and record the renewal in the International Register. The effective date of the renewal is the same for all designations contained in the international registration, irrespective of the date on which such designations were recorded in the International Register. Where the international registration designating the EU is renewed, the Office will be notified by the International Bureau.

If the international registration is not renewed, it can be converted into national marks or into subsequent designations of Member States under the Madrid Protocol. The three-month time limit for requesting conversion starts on the day following the last day on which renewal may still be effected before WIPO pursuant to Article 7(4) of the Madrid Protocol (see the Guidelines, Part E, Register Operations, Section 2, Conversion).

***GUIDELINES FOR EXAMINATION IN THE
OFFICE FOR HARMONIZATION IN THE
INTERNAL MARKET (TRADE MARKS AND
DESIGNS) ON COMMUNITY TRADE MARKS***

PART E

REGISTER OPERATIONS

SECTION 5

INSPECTION OF FILES

Table of Contents

1	General Principles	4
2	The Registers of Community Trade Marks and Community Designs ...	5
3	Inspection of the Registers.....	5
3.1	Information contained in the Registers	5
3.1.1	The Register of Community trade marks.....	5
3.1.2	The Register of Community designs	5
4	Inspection of Files	6
4.1	Persons/Entities authorised to request access to the files	6
4.2	Documents that constitute the files	6
4.2.1	The files relating to Community trade mark applications	7
4.2.2	The files relating to Community design applications	8
4.2.3	The files relating to registered Community trade marks.....	8
4.2.4	The files relating to registered Community designs	8
4.2.5	The files relating to international registrations designating the European Union	9
5	Parts of the File Excluded from Inspection	9
5.1	Excluded documents	9
5.1.1	Documents relating to exclusion or objection.....	10
5.1.2	Draft decisions and opinions and internal documents.....	10
5.1.3	Parts of the file for which the party concerned expressed a special interest in keeping confidential.....	11
5.2	Access for applicant or proprietor to excluded documents.....	12
6	Procedures Before the Office Relating to Applications for Inspection of Files	12
6.1	Certified or uncertified extracts of the registers	12
6.1.1	Extracts from the Register of Community trade marks.....	12
6.1.2	Extracts from the Register of Community Designs.....	13
6.2	Certified or uncertified copies of file documents.....	13
6.3	Online access to the files.....	14
6.4	Downloadable certified copies	14
6.5	Online applications for inspection of files.....	15
6.6	Written applications for inspection of files.....	15
6.7	Languages	16
6.7.1	For CTM or CD applications	16
6.7.2	For registered CTMs or RCDs.....	16
6.8	Representation and authorisation.....	17
6.9	Contents of the application for inspection of files.....	17
6.10	Deficiencies	17

6.11 Fees for inspection and communication of information contained in the files	18
6.11.1 Communication of information contained in a file.....	18
6.11.2 Inspection of the files.....	18
6.11.3 Consequences of failure to pay.....	19
6.11.4 Refund of fees	20
6.12 Requirements concerning the right to obtain inspection of files concerning an unpublished CTM application, or a deferred RCD filed by a third party.....	20
6.12.1 Consent	20
6.12.2 Statement that CTM or RCD rights will be invoked	21
6.13 Grant of inspection of files, means of inspection	21
6.13.1 Communication of information contained in a file.....	21
6.13.2 Copies of file documents	22
7 Procedures to Give Access to the Files to Courts or Authorities of the Member States	22
7.1 No fees	22
7.2 No restriction as to unpublished applications	23
7.3 Means of inspection	23

1 General Principles

Articles 87, 88 and 90 CTMR
Articles 72, 74, and 75 CDR
Rules 84(1), 89, 90, 92 and 93 CTMIR
Article 69(1), Articles 74, 75, 77 and 78 CDIR
Article 2(27) CTMFR

The principle established under the Community trade mark and design system is that:

- the 'Register of Community Trade Marks' and the 'Register of Community Designs' contain all particulars relating to Community trade mark and design applications and registered Community trade marks and designs; and
- the 'files' contain all correspondence and decisions relating to those trade marks and designs.

Both the Registers and the files of the Office are in principle open to inspection by the public. However, before publication of a CTM application, a Community Design registration or when a Registered Community Design (RCD) is subject to deferred publication, inspection of files is possible only in exceptional cases (see paragraphs 4.2.1 and 4.2.2 below).

All the information in the Registers is stored in the Office's databases and, where applicable, published in the CTM/RCD Bulletin in electronic format.

This section of the Guidelines deals specifically with inspection of files.

Inspection of the files may involve:

- inspection of the registers;
- obtaining certified or uncertified extracts of the registers;
- inspection of the actual file document(s);
- the communication of information contained in the files, implying communication of specific information contained in the files without supplying the actual file document(s);
- obtaining certified or uncertified copies of documents contained in the files.

In these Guidelines, the term 'inspection of the files' is used to cover all of the abovementioned forms of inspection of files, unless otherwise stated.

The provisions in the CDR and CDIR dealing with inspection of files of Community designs are almost identical to the equivalent provisions of the CTMR and CTMIR, respectively. Therefore, the following applies *mutatis mutandis* to Community designs. Where the procedure is different, these differences are specified under a separate sub-heading.

2 The Registers of Community Trade Marks and Community Designs

Article 87 CTMR
Article 72 CDR
Rule 84 CTMIR
Article 69 CDIR

The Registers are maintained electronically and consist of entries in the Office's database systems. They are available on the Office website for public inspection, except, in the case of Community designs, to the extent that Article 50(2) CDR provides otherwise. Insofar as some data contained in the Registers are not yet available online, the only means of access is by a request for information or by obtaining certified or uncertified extracts or copies of the file documents from the Registers subject to the payment of a fee.

3 Inspection of the Registers

3.1 Information contained in the Registers

3.1.1 The Register of Community trade marks

Rule 84 CTMIR
Decision No EX-00-1 of the President of the Office of 27 November 2000 concerning entries in the Register of Community Trade Marks
Decision No EX-07-1 of the President of the Office of 16 March 2007 concerning entries in the Register of Community Trade Marks

The Register of Community Trade Marks contains the information specified in Rule 84 CTMIR and any other items determined by the President of the Office.

3.1.2 The Register of Community designs

Article 50 CDR
Articles 69 and 73 CDIR
Decision No EX-07-2 of the President of the Office of 16 March 2007 concerning entries in the Register of Community Designs

The Register of Community Designs contains the information specified in Article 69 CDIR and any other items determined by the President of the Office.

In accordance with Article 73(a) CDIR, where the registered Community designs are subject to a deferment of publication pursuant to Article 50(1) CDR, access to the Register to persons other than the holder shall be limited to the name of the holder, the name of any representative, the date of filing and registration, the file number of the application and the mention that publication is deferred.

4 Inspection of Files

4.1 Persons/Entities authorised to request access to the files

The rules and degree of access to the files vary according to who requests inspection.

The Regulations and the Implementing Regulations differentiate between the following three categories:

- the applicant/proprietor of the Community trade mark or design;
- third parties;
- courts or authorities of the Member States.

Inspection of the files by courts or authorities of the Member States is covered by the system of administrative cooperation with the Office (see paragraph 7 below).

4.2 Documents that constitute the files

The files relating to a CTM or RCD consist of all correspondence between the applicant/proprietor and the Office and all documents established in the course of examination, as well as any correspondence concerning the ensuing Community trade mark or Community design. The file does not include trade mark search reports provided by national Offices.

Documents relating to opposition, cancellation, invalidity and appeal proceedings before the Office or other proceedings, such as recordals (transfer, licence etc.), also form part of the files.

Where the parties make use of the mediation services offered by the Office in accordance with Decision No 2011-1 of the Presidium of the Boards of Appeal of 14 April 2011 on the amicable settlement of disputes, or the conciliation services in accordance with Decision No 2014-2 of the Presidium of the Boards of Appeal of 31 January 2014, on the friendly settlement of disputes by the competent Board, all correspondence relating to that mediation or conciliation are excluded from inspection of files.

Rule 91 CTMIR Article 76 CDIR

Even where a CTM application is no longer pending or a CTM registration or CD registration cease to have effect, inspection of the respective files remains possible just as if the application or registration were still pending or effective, as long as the files are kept. A CTM application or CD application ceases to be pending when it is rejected, or when the application has been withdrawn or deemed to be withdrawn, and a CTM registration or CD registration ceases to have effect when it expires or is surrendered, declared invalid or revoked. The Office will keep the complete files for at least five years from the end of the year in which such an event occurs.

4.2.1 The files relating to Community trade mark applications

Articles 39 and 88 CTMR
Rules 12, 85 and Rule 89(2) CTMIR

The files relating to Community trade mark applications are available for inspection of files once the application has been published by the Office in the Community Trade Marks Bulletin. The day of publication is the date of issue shown in the Community Trade Marks Bulletin and is reflected under the INID code 442 in the Register. The dissemination of data relating to unpublished CTM applications by means of online access or otherwise does not constitute publication of the application within the meaning of Article 39 CTMR and Rule 12 CTMIR.

Before the publication of the application, inspection of the files is restricted and possible only if one of the following conditions is fulfilled:

- the applicant for inspection is the CTM applicant/proprietor; or
- the CTM applicant has consented to inspection of the file relating to the CTM application (see paragraph 6.12.1 below); or
- the applicant for inspection can prove that the CTM applicant has stated that it will invoke the rights under the CTM, once registered, against the applicant for inspection (see paragraph 6.12.2 below).

Article 36(3) CTMR
Rule 91 CTMIR

The applicant always has access to the files relating to its own CTM application. This comprises the following:

- the CTM application, even where the Office has refused to attribute a filing date to it or where the application does not fulfil the minimum requirements for the attribution of a filing date, in which case the application will not be dealt with as a CTM application and, legally speaking, there is no CTM application;
- the files for as long as they are kept (see paragraph 4.2), even after the CTM application has been rejected or withdrawn.

4.2.2 The files relating to Community design applications

Articles 50 and 74 CDR Article 70 and Article 74(2) CDIR

The files relating to Community design applications, or applications for a registered Community design that are subject to deferment of publication, which have been surrendered before or on the expiry of that period or, pursuant to Article 50(4) CDR, are deemed from the outset not to have had the effects specified in that Regulation, are available for inspection only if one of the following conditions is fulfilled:

- the applicant for inspection is the CD applicant/proprietor; or
- the applicant for the Community design has consented to inspection of the file relating to the Community design application; or
- the applicant for inspection has established a legitimate interest in the inspection of the Community design application, in particular where the applicant for the Community design has stated that after the design has been registered he/she will invoke the rights under it against the person requesting the inspection.

In the case of an application for multiple Community designs, this inspection restriction will only apply to information relating to the Community designs subject to deferment of publication, or to those that are not eventually registered, either due to rejection by the Office or withdrawal by the applicant.

4.2.3 The files relating to registered Community trade marks

The files relating to Community trade marks after registration are available for inspection.

4.2.4 The files relating to registered Community designs

The files relating to registered Community designs are available for inspection once the registration has been published by the Office in the Community Designs Bulletin. The day of publication is the date of issue shown in the Community Designs Bulletin and is reflected under the INID code 45 in the Register.

Where inspection of the files relates to a registered Community design that is subject to deferment of publication under Article 50 CDR, or which, being subject to such deferment, has been surrendered before or on the expiry of that period or which, pursuant to Article 50(4) CDR, is deemed from the outset not to have had the effects specified in that Regulation, inspection of files of the registration is restricted and possible only if one of the following conditions is fulfilled:

- the holder of the Community design has consented to inspection of the file relating to the Community design registration;
- the applicant for inspection has established a legitimate interest in the inspection of the files of the Community design registration, in particular where the holder of

the Community design has taken steps with a view to invoking the rights under it against the person requesting the inspection.

In the case of an application for multiple Community designs, this inspection restriction will apply only to information relating to the Community designs subject to deferment of publication, or to those that are not eventually registered either due to rejection by the Office or withdrawal by the applicant.

4.2.5 The files relating to international registrations designating the European Union

Articles 151 and 152 CTMR Article 106(d) CDR Rule 89 CTMIR Article 71 CDIR

International registrations are exclusive rights administered by the International Bureau of the World Intellectual Property Organization (WIPO) in Geneva according to the Madrid Protocol (in the case of trade marks) and the Geneva Act (in the case of designs). WIPO processes the applications and then sends them to the Office for examination in accordance with the conditions specified in the CTMR and in the CDR. These registrations have the same effect as applying directly for a Community trade mark or a registered Community design.

The files kept by the Office relating to international trade mark registrations designating the European Union may be inspected on request as from the date of publication referred to in Article 152(1) CTMR and subject to Rule 88 CTMIR.

The Office provides information on international registrations of designs designating the EU in the form of an electronic link to the searchable database maintained by the International Bureau (<http://www.wipo.int/designdb/hague/en/>). The files kept by the Office may relate to refusal of international design pursuant to Article 106e CDR and the invalidation of the international design pursuant to Article 106f CDR. They may be inspected subject to the restrictions pursuant to Article 72 CDIR (see paragraph 5, Parts of the File Excluded from Inspection below).

5 Parts of the File Excluded from Inspection

5.1 Excluded documents

Article 137 CTMR Rule 88 CTMIR Article 72 CDIR
--

Certain documents contained in the files are excluded from inspection of files, namely:

- documents relating to the exclusion of or objection to Office staff, for example on the grounds of suspicion of partiality;
- draft decisions and opinions and all other internal documents used for preparing decisions and opinions;

- parts of the file for which the party concerned expressed a special interest in keeping confidential;
- all documents relating to the invitation of the Office to find a friendly settlement, except those that have an immediate impact on the trade mark or design, such as limitations, transfers etc., and have been declared to the Office. (For mediation and conciliation proceedings, see paragraph 4.2 above).

5.1.1 Documents relating to exclusion or objection

Rule 88(a) CTMIR Article 72(a) CDIR
--

This exception relates to documents in which an examiner states that they consider themselves excluded from participating in the case, as well as documents in which such a person makes observations about an objection by a party to the proceedings on the basis of a ground for exclusion or suspicion of partiality. However, it does not relate to letters in which a party to the proceedings raises, either separately or together with other statements, an objection based on a ground for exclusion or suspicion of partiality, or to any decision on the action to be taken in the cases mentioned above. The decision taken by the competent instance of the Office, without the person who withdraws or has been objected to, will form part of the files.

5.1.2 Draft decisions and opinions and internal documents

Rule 88(b) CTMIR Article 72(b) CDIR
--

This exception relates to documents used for preparing decisions and opinions, such as reports and notes drafted by an examiner that contain considerations or suggestions for dealing with or deciding on a case, or annotations containing specific or general instructions on dealing with certain cases.

Documents that contain a communication, notice or final decision by the Office in relation to a particular case are not included in this exception. Any document to be notified to a party to the proceedings will take the form of either the original document or a copy thereof, certified by or bearing the seal of the Office, or a computer print-out bearing that seal. The original communication, notice or decision or copy thereof will remain in the file.

The Notes and the Guidelines of the Office relating to general procedure and treatment of cases, such as these Guidelines, do not form part of the files. The same is true for measures and instructions concerning the allocation of duties.

5.1.3 Parts of the file for which the party concerned expressed a special interest in keeping confidential

Rule 88(c) CTMIR Article 72(c) CDIR
--

Point in time for the request:

Keeping all or part of a document confidential may be requested on its submission or at a later stage, as long as there is no pending request for an inspection of files. During inspection of files proceedings confidentiality may not be requested.

Parts of the file for which the party concerned expressed a special interest in keeping confidential before the application for inspection of files was made are excluded from inspection of files, unless their inspection is justified by an overriding legitimate interest of the party seeking inspection.

The party concerned must have expressly invoked, and sufficiently justified, a special interest in keeping the document confidential when they submitted it. The official forms of the Office are excluded from inspection of files.

Where the party concerned requests confidentiality but does not justify its interest in keeping the document confidential, the Office will reject the request for confidentiality and will invite the party concerned to file observations within two months.

If a special interest in keeping a document confidential is invoked, the Office must check whether that special interest is sufficiently demonstrated. The documents falling into this category must originate from the party concerned (e.g. CTM/RCD applicant, opponent). The special interest must be due to the confidential nature of the document or its status as a trade or business secret. This may be the case, for example, where the applicant has submitted underlying documentation as evidence in respect of a request for registration of a transfer or licence. Where the Office concludes that the requirements for keeping documents confidential are not met, it will communicate with the person who filed the documents and make a decision. The applicant may submit evidence in such a way that avoids revealing parts of the document or information that the applicant considers confidential, as long as the parts of the document submitted contain the required information. For example, where contracts or other documents are submitted as evidence for a transfer or licence, certain information may be blacked out before being submitted to the Office, or certain pages may be omitted altogether.

In the event that the Office invites the parties to opposition, cancellation or invalidity proceedings to consider a friendly settlement, all corresponding documents referring to those proceedings are considered confidential and in principle not open to inspection of files.

Access to documents that the Office has accepted as being confidential and thus, excluded from inspection, may nevertheless be granted to a person who demonstrates an overriding legitimate interest in inspecting the document. The overriding legitimate interest must be that of the person requesting inspection.

If the file contains such documents, the Office will inform the applicant for inspection of files about the existence of such documents within the files. The applicant for

inspection of files may then decide whether or not it wants to file a request invoking an overriding legitimate interest. Each request must be analysed on its own merits.

The Office must give the party requesting inspection the opportunity to present its observations.

Before taking a decision, the request, as well as any observations, will have to be sent to the party concerned, who has a right to be heard.

Article 59 CTMR Article 56 CDR

The Office must make a decision as to whether to grant access to such documents. Such a decision will be subject to appeal by the adversely affected party.

5.2 Access for applicant or proprietor to excluded documents

Rule 88 CTMIR Article 72 CDIR

Where an applicant or proprietor requests access to their own file, this will mean all documents forming part of the file, excluding only those documents referred to in Rule 88(a) and (b) CTMIR and Article 72(a) and (b) CDIR.

In *inter partes* proceedings where the other party concerned (the opponent or applicant for revocation or declaration of invalidity) has shown a special interest in keeping its document confidential vis-à-vis third parties, it will be informed that the documents cannot be kept confidential with respect to the other party to the proceedings and it will be invited to either disclose the documents or withdraw them from the proceedings. If it confirms the confidentiality, the documents will not be sent to the other party and will not be taken into account by the Office in the decision.

If, on the other hand, it wants the documents to be taken into account but not available for third parties, the documents can be forwarded by the Office to the other party to the proceedings, but will not be available for inspection by third parties (for opposition proceedings, see the Guidelines, Part C, Opposition, Section 1, Procedural Matters).

6 Procedures Before the Office Relating to Applications for Inspection of Files

6.1 Certified or uncertified extracts of the registers

6.1.1 Extracts from the Register of Community trade marks

Rule 84(6) CTMIR

The Office shall provide certified or uncertified extracts from the Register on request, on payment of a fee.

Requests for an extract from the Register of Community Trade Marks may be submitted by filing the official 'Application for an Inspection of File' form, available in all languages of the Office or any equivalent request.

Any language version of this form may be used, provided that it is completed in one of the languages referred to in paragraph 6.7 below.

Rules 80 and 82 CTMIR

An application for inspection of files may be submitted as a signed original form by fax, post or electronic means (see paragraph 6.5 below).

6.1.2 Extracts from the Register of Community Designs

Article 50 CDR Articles 69 and 73 CDIR

Subject to Article 73 CDIR, the Office shall provide certified or uncertified extracts from the Register on request, on payment of a fee.

Where the registration is subject to a deferment of publication, pursuant to Article 50(1) CDR, certified (or uncertified) extracts from the Register shall contain only the name of the holder, the name of any representative, the date of filing and registration, the file number of the application and the mention that publication is deferred, except where the request has been made by the holder or his/her representative.

Requests for an extract from the Register of Community Designs may be submitted by filing the official 'Application for an Inspection of File' form, available in all languages of the Office or any equivalent request.

Any language version of this form may be used, provided that it is completed in one of the languages referred to in paragraph 6.7 below.

Articles 65, 66, 67 CDIR

An application for inspection of files may be submitted as a signed original by fax, post or electronic means (see paragraph 6.5 below).

6.2 Certified or uncertified copies of file documents

The Office shall provide certified or uncertified copies of documents constituting the files (see paragraph 4.2 above) on request, on payment of a fee.

Requests for certified or uncertified copies of documents may be submitted by filing the official 'Application for an Inspection of File' form, available in all languages of the Office or any equivalent request.

Any language version of this form may be used, provided that it is completed in one of the languages referred to in paragraph 6.7 below.

Certified and uncertified copies of the CTM and RCD applications, registration certificates, extracts of the Register and copies of the documents in the file (available only for CTM), may also be requested as an alternative to the downloadable copies available free of charge (see paragraph 6.4 below).

Certified copies of the CTM application or the RCD registration certificate will only be available when a filing date has been accorded (for CTM filing date requirements, see the Guidelines, Part B, Examination, Section 2, Formalities; for RCD filing date requirements, see the Guidelines on Examination of Applications for Registered Community Designs).

In the case of an application for multiple designs, certified copies of the application will only be available for those designs that have been accorded a filing date.

Where the CTM application or RCD registration has not yet been published, a request for certified or uncertified copies of the file documents will be subject to the restrictions listed in paragraphs 4.2.1 to 4.2.4 above.

It should be borne in mind that the certified copy of the application or registration only reflects the data on the date of application/registration. The trade mark or design may have been the subject of a transfer, surrender, partial surrender or other act affecting its scope of protection, which will not be reflected in the certified copy of the CTM application form or CTM/RCD registration certificate. Up-to-date information is available from the electronic database or by requesting a certified extract of the Register (see paragraph 6.1 above).

6.3 Online access to the files

The contents of the files are available in the 'Correspondence' section of the file in the Office's [online tool](#) on the Office's website.

Providing the CTM application or the CD registration (not subject to a deferment) has been published, registered users of the website can consult these files free of charge.

6.4 Downloadable certified copies

Decision No EX-13-2 of the President of the Office of 26 November 2013 concerning electronic communication with and by the Office ('Basic Decision on Electronic Communication'), Article 6.

Certified and uncertified copies of the CTM and RCD applications, registration certificates, extracts of the Register and copies of the documents in the file (available only for CTM) can be automatically generated and downloaded via a direct link from the Office's website via the Office's online tool, from within the Inspection of Files e-filing form and from within the files for a selected CTM or RCD.

In the list of documents, an icon appears next to the document for which a certified or uncertified copy can be downloaded. Clicking on the icon will generate a certified or uncertified copy of the document in PDF format.

The PDF document is composed of a cover page in the five Office languages, introducing the certified document and containing a unique identification code for the original document, followed by the certified document itself (CTM application form, CTM registration certificate or RCD registration certificate). Each page of the document should bear a header and footer containing important elements in order to guarantee the authenticity of the certified copy: a unique identification code, a 'copy' stamp, the signature of the Office staff member responsible for issuing certified copies, the date of the certified copy, the CTM/RCD number and page number. The date indicated is the date when the certified copy was automatically generated.

The automatically generated certified copies have the same value as certified copies sent on paper upon request, and can either be used in electronic format or printed.

When an authority receives a certified copy, it can verify the original document online using the unique identification code given in the certified copy. A link 'Verify certified copies' is available under the 'Databases' section of the Office's website. Clicking on the link will bring up a screen with a box in which the unique identification code can be entered in order to retrieve and display the original document from the Office's online systems.

It should be borne in mind that the certified copy only reflects the data on the date of application/registration. The trade mark or design may have been the subject of a transfer, surrender, partial surrender or other act affecting its scope of protection, which will not be reflected in the certified copy of the CTM application form or CTM/RCD registration certificate. Up-to-date information is available from the electronic database or by requesting a certified extract of the Register or database.

6.5 Online applications for inspection of files

Applications for inspection may be filed online. Users may access the application form by clicking on the icon in the detail page of a selected CTM or RCD. They will then be re-directed to their user account where they will be invited to login and complete the application for inspection of files requesting certified or uncertified copies of specific documents.

6.6 Written applications for inspection of files

Rule 79 CTMIR Article 65 CDIR

Applications for inspection may be submitted by filing the official 'Application for an Inspection of File' form, available in all languages of the Office or any equivalent request.

Any language version of this form may be used, provided that it is completed in one of the languages referred to in paragraph 6.7 below.

Rules 80 and 82 CTMIR
Article 67 CDIR

An application for inspection of files may be submitted as a signed original form by fax, post or electronic means (see paragraph 6.5 above).

6.7 Languages

Applications for inspection of files must be filed in one of the languages indicated below.

6.7.1 For CTM or CD applications

Rule 95(a), Rules 96 and 98 CTMIR
Articles 80, 81, 83 and 84 CDIR

Where the application for an inspection of files relates to a Community trade mark application or Community design application, whether already published or not, it must be filed in the language in which the CTM application or CD application was filed (the 'first' language) or in the second language indicated by the CTM applicant or CD applicant in their application (the 'second' language).

Where the application for inspection is filed in a language other than indicated above, the applicant for inspection must, of its own motion, submit a translation into one of the languages indicated above within one month. If such a translation is not submitted within the deadline, the application for inspection of files will be deemed not to have been filed.

This does not apply where the applicant for inspection could not have been aware of the languages of the CTM application or RCD application (which can be the case only where such information is not available in the online register and the application can immediately be dealt with). In this case, the application for inspection may be filed in any of the five languages of the Office.

6.7.2 For registered CTMs or RCDs

Rule 95(b), Rules 96 and 98 CTMIR
Article 80(b), Rules 81, 83 and 84 CDIR

Where the application for inspection of files relates to a registered CTM or RCD, it must be filed in one of the five languages of the Office.

The language in which the application for inspection was filed will become the language of the inspection proceedings.

Where the application for inspection of files is made in a language other than indicated above, the party requesting inspection must, on its own motion, submit a translation into one of the languages indicated above within one month, or the application for inspection of files will be deemed not to have been filed.

6.8 Representation and authorisation

Representation is not mandatory for filing an application for inspection of files.

Where a representative is appointed, the general rules for representation and authorisation apply. See the Guidelines, Part A, General Rules, Section 5, Professional Representation.

6.9 Contents of the application for inspection of files

The application for inspection of files mentioned in paragraphs 6.5 and 6.6 above must contain the following:

- an indication of the file number or registration number for which inspection is applied for;
- the name and address of the applicant for inspection of files;
- if appropriate, an indication of the document or information for which inspection is applied for (applications may be made to inspect the whole file or specific documents only). In the event of an application to inspect a specific document, the nature of the document (e.g. 'application', 'notice of opposition') needs to be stated. Where communication of information from the file is applied for, the type of information needed must be specified. Where the application for inspection relates to a CTM application that has not yet been published, the application for a registered Community design that has not yet been published or a registered Community design that is subject to deferment of publication in accordance with Article 50 CDR or which, being subject to such deferment, has been surrendered before or on the expiry of that period, and inspection of the files is applied for by a third party, an indication and evidence to the effect that the third party concerned has a right to inspect the file;
- where copies are requested, an indication of the number of copies requested, whether or not they should be certified and, if the documents are to be presented in a third country requiring an authentication of the signature (*legalisation*), an indication of the countries for which authentication is needed;
- the applicant's signature in accordance with Rule 79 CTMIR and Article 65 CDIR.

6.10 Deficiencies

Where an application for inspection of the files fails to comply with the requirements concerning the contents of applications, the applicant for inspection will be invited to remedy the deficiencies. If deficiencies are not remedied within the fixed time limit, the application for inspection will be refused.

6.11 Fees for inspection and communication of information contained in the files

All fees are due on the date of receipt of the application for inspection (see paragraphs 6.5 and 6.6 above).

6.11.1 Communication of information contained in a file

Rule 90 CTMIR
Article 75 CDIR
Article 2(29) CTMFR
Article 2 CDFR in conjunction with Annex(23) CDFR

Communication of information in a file is subject to payment of a fee of EUR 10.

6.11.2 Inspection of the files

Rule 89(1) CTMIR
Article 74(1) CDIR
Article 2(27) CTMFR
Article 2 CDFR in conjunction with Annex(21) CDFR

A request for inspection of the files on the Office premises is subject to payment of a fee of EUR 30.

Rule 89(4) CTMIR
Article 74(4) CDIR
Article 2(28)(a) CTMFR
Article 2 CDFR in conjunction with Annex(22) CDFR

Where inspection of a file is obtained through the issuing of **uncertified** copies of file documents, those copies are subject to payment of a fee of EUR 10 plus EUR 1 for every page exceeding ten.

Rules 24(2), 84(6) and 89(5) CTMIR
Articles 17(2), 69(6) and 74(5) CDIR
Article 2(26)(a) CTMFR
Article 2 CDFR in conjunction with Annex(20) CDFR

An **uncertified** copy of a CTM application or RCD application, an **uncertified** copy of the certificate of registration, an **uncertified** extract from the Register or an **uncertified** extract of the CTM application or RCD application from the database is subject to payment of a fee of EUR 10 per copy or extract.

Rule 89(4) CTMIR
Article 74(4) CDIR
Article 2(28)(b) CTMFR
Article 2 CDFR in conjunction with Annex(22) CDFR

Where inspection of a file is obtained through the issuing of **certified** copies of file documents, those copies are subject to payment of a fee of EUR 30 plus EUR 1 for every page exceeding ten.

Rules 24(2), 84(6) and 89(5) CTMIR
Articles 17(2), 69(6) and 74(5) CDIR
Article 2(26)(b) CTMFR
Article 2 CDFR in conjunction with Annex(20) CDFR

A **certified** copy of a CTM application or RCD application, a **certified** copy of the certificate of registration, a **certified** extract from the Register or a **certified** extract of the CTM application or RCD application from the database is subject to payment of a fee of EUR 30 per copy or extract.

However, registered users of the website can obtain electronic certified copies of CTM or RCD applications or registration certificates free of charge through the website.

6.11.3 Consequences of failure to pay

Rule 89(1) CTMIR
Article 74(1) CDIR

An application for inspection of files will be deemed not to have been filed until the fee has been paid. The fees apply not only where the application for inspection has been filed by a third party, but also where it has been filed by the CTM or RCD applicant or proprietor. The Office will not process the inspection application until the fee has been paid.

However, if the fee is not paid or is not paid in full, the Office will notify the applicant for inspection:

- if no payment is received by the Office for a certified or uncertified copy of a CTM application or RCD application, a certificate of registration or an extract from the Register or from the database;
- if no payment is received by the Office for inspection of the files obtained through the issuing of certified or uncertified copies of file documents;
- if no payment is received by the Office for the communication of information contained in a file.

The Office will issue a letter indicating the amount of fees to be paid. If the exact amount of the fee is not known to the applicant for inspection because it depends on the number of pages, the Office will either include that information in the standard letter or inform the applicant for inspection by other appropriate means.

6.11.4 Refund of fees

Where the application to obtain certified or uncertified copies or information contained in the files is withdrawn before the Office has dealt with it, the fee will be refunded or, in the case of a current account, the account will not be debited.

Where an application for inspection of the files is rejected, the corresponding fee is not refunded. However, where, subsequent to the payment of the fee the Office finds that not all the certified or uncertified copies requested may be issued, any fees is paid in excess of that which is eventually due will be refunded.

6.12 Requirements concerning the right to obtain inspection of files concerning an unpublished CTM application, or a deferred RCD filed by a third party

Article 88(1) and (2) CTMR Article 74 CDR Rule 89(2) CTMIR Article 74(2) CDIR
--

Where an application for inspection of files for a CTM application that has not yet been published, or for files relating to an RCD subject to deferment of publication in accordance with Article 50 CDR, or for those which, subject to such deferment, have been surrendered before or on the expiry of that period, (see paragraphs 4.2.1 and 4.2.2 above) is filed by a third party (*that is by a person other than the CTM or RCD applicant or its representative*), different situations may arise.

If the application by a third party is based on the grounds specified in Rule 89(2) CTMIR (see paragraph 4.2.1 above), or in Article 74(2) CDIR or Article 74(2) CDR (see paragraph 4.2.2 above) it must contain an indication and evidence to the effect that the CTM applicant or RCD applicant or holder has consented to the inspection, or has stated that it will invoke the rights under the CTM or RCD, once registered, against the applicant for inspection.

6.12.1 Consent

The CTM applicant RCD applicant or holder's consent must be in the form of a written statement in which it consents to the inspection of the particular file(s). Consent may be limited to inspection of certain parts of the file, such as the application, etc., in which case the application for inspection of files may not exceed the scope of the consent.

Where the applicant for inspection of files does not submit a written statement from the CTM applicant, RCD applicant or holder consenting to the inspection of the files, the applicant for inspection will be notified and given two months from the date of notification to remedy the deficiency.

If, after expiry of the time limit, no consent has been submitted, the Office will refuse the application for inspection of files. The applicant for inspection will be informed of the decision to refuse the application for inspection.

The decision may be appealed by the applicant for inspection (Articles 59 and 60 CTMR and 56 CDR).

6.12.2 Statement that CTM or RCD rights will be invoked

Rule 89(2) CTMIR Article 74(2) CDR Article 74(2) CDIR

Where the application relies on the allegation that the CTM or RCD proprietor will invoke the rights under the CTM or RCD, once registered, it is up to the applicant for inspection to prove this allegation. The evidence to be submitted must take the form of documents, for example, statements by the CTM applicant or RCD applicant or holder for the CTM application, RCD application or registered and deferred Community design in question, business correspondence, etc. Filing an opposition based on a CTM application against a national mark constitutes a statement that the CTM will be invoked. Mere assumptions on the part of the applicant for inspection of the file will not constitute sufficient proof.

The Office will first examine whether the proof is sufficient.

If so, the Office will send the application for inspection of files and the supporting documents to the CTM applicant or RCD applicant or holder and invite it to comment within two months. If the CTM applicant or RCD applicant or holder consents to an inspection of the files, it will be granted. If the CTM applicant or RCD applicant or holder submits comments contesting inspection of the files, the Office will send the comments to the applicant for inspection. Any further statement by the applicant for inspection will be sent to the CTM applicant or RCD applicant or holder and vice versa. The Office will take into account all submissions made on time by the parties and decide accordingly. The Office's decision will be notified to both the applicant for inspection of the files and the CTM applicant or RCD applicant or holder. It may be appealed by the adversely affected party (Articles 59 and 60 CTMR and 56 CDR).

6.13 Grant of inspection of files, means of inspection

When inspection is granted, the Office will, as appropriate, send the requested copies of file documents, or requested information, to the applicant for inspection or invite it to inspect the files at the Office's premises.

6.13.1 Communication of information contained in a file

Rule 90 CTMIR Article 75 CDIR

The Office may, upon request, communicate information contained in any file relating to CTM or RCD applications or registrations.

Information contained in the files will be provided without an inspection application, *inter alia*, where the party concerned wishes to know whether a given CTM application has been filed by a given applicant, the date of such application, or whether the list of

goods and services has been amended in the period between the filing of the application and publication.

Having obtained this information, the party concerned may then decide whether or not to request copies of the relevant documents, or to apply for inspection of the actual file.

Where the party concerned wishes to know, inter alia, which arguments an opponent has brought forward in opposition proceedings, which seniority documents have been filed, or the exact wording of the list of goods and services as filed, such information will not be provided. Instead the Office will advise the party to apply for inspection of the actual file.

In such cases, the quantity and complexity of the information to be supplied would exceed reasonable limits and create an undue administrative burden.

6.13.2 Copies of file documents

Where inspection of the files is granted in the form of the provision of certified or uncertified copies of file documents, the requested documents will be sent by post.

Where inspection of files is granted on the Office premises, the applicant will be given an appointment to inspect the files.

7 Procedures to Give Access to the Files to Courts or Authorities of the Member States

Article 90 CTMR Article 75 CDR Rules 92 and 93 CTMIR Articles 77 and 78 CDIR

For the purposes of administrative co-operation, the Office will, upon request, assist courts or authorities of the Member States by communicating information or opening files for inspection.

For the purposes of administrative co-operation, the Office will also, upon request, communicate relevant information about the filing of CTM or RCD applications and proceedings relating to such applications and the marks or designs registered as a result thereof to the central industrial property offices of the Member States.

7.1 No fees

Rules 92(3) and 93(1), (2) CTMIR Articles 77(3) and 78(1), (2) CDIR
--

Inspection of files and communication of information from the files requested by the courts or authorities of the Member States are not subject to the payment of fees.

Rule 93(2) CTMIR
Article 78(2) CDIR

Courts or public prosecutors' offices of a Member State may open to inspection by third parties files, or copies thereof that have been transmitted to them by the Office. The Office will not charge any fee for such inspection.

7.2 No restriction as to unpublished applications

Article 90 CTMR
Article 75 CDR
Rule 88 and Rule 92(1) CTMIR
Article 72 and Article 77(1) CDIR

Inspection of files and communication of information from the files requested by the courts or authorities of the Member States is not subject to the restrictions contained in Article 88 CTMR and Article 74 CDR. Consequently, these bodies may be granted access to files relating to unpublished CTM applications (see paragraph 4.2.1 above) and RCD's subject to deferment of publication (see paragraph 4.2.2 above) as well as to parts of the files for which the party concerned has expressed a special interest in keeping confidential. However, documents relating to exclusion and objection, as well as the documents referred to in Rule 88(b) CTMIR and Article 72(b) CDIR, will not be made available to these bodies.

Rule 88 and Rule 93(2) CTMIR
Article 74 CDR and Article 72 and Article 78(2) CDIR

Courts or public prosecutors' offices of the Member States may open to inspection by third parties files or copies that have been transmitted to them by the Office. Such subsequent inspection shall be subject to the restrictions contained in Article 88 and Rule 88 CTMIR or Article 74 CDR, as if the inspection had been requested by a third party.

Rule 93(3) CTMIR
Article 78(4) CDIR

When transmitting files or copies thereof to the courts or public prosecutors' offices of the Member States, the Office will indicate the restrictions imposed on inspection of files relating, on the one hand to CTM applications or registered Community trade marks pursuant to Article 88 CTMR and Rule 88 CTMIR, and on the other hand to CD applications or RCD registrations pursuant to Article 74 CDR and Article 72 CDIR.

7.3 Means of inspection

Rule 93(1) CTMIR
Article 78(1) CDIR

Inspection of the files relating to CTM/RCD applications or registrations by courts or authorities of the Member States may be granted by providing copies of the original documents. As the files contain no original documents as such, the Office will provide printouts from the electronic system.

***GUIDELINES FOR EXAMINATION IN THE
OFFICE FOR HARMONIZATION IN THE
INTERNAL MARKET (TRADE MARKS AND
DESIGNS) ON COMMUNITY TRADE MARKS***

PART E

REGISTER OPERATIONS

SECTION 6

OTHER ENTRIES IN THE REGISTER

CHAPTER 1

COUNTERCLAIMS

Table of Contents

1	Introduction.....	3
2	Application to Register the Filing of a Counterclaim Before a CTM or CD Court.....	3
3	Application to Register a Judgment on a Counterclaim Before a CTM or CD court.....	4

1 Introduction

Counterclaims, as provided for in Article 100 CTMR or Article 84 CDR, are defence claims of the defendant who is sued for the infringement of a Community trade mark (CTM) or Registered Community Design (RCD). By way of such a counterclaim the defendant asks the Community trade mark court or Community design court to declare the revocation or invalidity of the CTM or the invalidity of the RCD which it is supposed to have infringed.

The purpose of recording the filing and the final judgment of the counterclaim in the Register of the Office lies in the general interest of making all the relevant information on counterclaims concerning CTMs and RCDs, in particular the final judgments thereof, publicly available. In this way the Office may implement these final judgments, in particular those which declare the total or partial revocation or invalidity of a CTM as well as those which declare the total invalidity of RCDs.

By entering such counterclaims and their final judgments in the Register, the Office strives to comply with the principles of conformity to truth, public faith and the legal certainty of a public Register.

2 Application to Register the Filing of a Counterclaim Before a CTM or CD Court

Article 100(4) CTMR
Rule 84(3)(n) CTMIR
Article 86(2) CDR
Article 69(3)(p) CDIR
Communication No 9/05 and No 10/05 of the President

According to Article 100(4) CTMR and Article 86(2) CDR, the Community trade mark and Community design court before which a counterclaim for revocation of a CTM or for a declaration of invalidity of the CTM or RCD has been filed shall inform the Office of the date on which the counterclaim was filed.

Communications No 9/05 and No 10/05 of 28/11/2005 concern the designation of Community trade mark and Community design courts of the Member States (hereinafter, 'CTM or CD courts') pursuant to Article 95(2) CTMR.

The Office also allows any party to the counterclaim proceedings to request the entry of a counterclaim in the Register, if not yet communicated by the CTM or CD court.

The recordal applicant (the CTM or CD court or one of the parties in the counterclaim proceedings) must indicate and submit:

- the date on which the counterclaim was filed,
- the number of the CTM or RCD concerned,
- an indication of whether the request is for revocation or for declaration of invalidity,
- if the recordal applicant is one of the parties, official confirmation from the CTM or CD court that has the authority to take the judgment on the counterclaim including, where possible, the case or reference number from the court.

If the recordal applicant does not submit official confirmation from the CTM or CD court, or if the information submitted by the applicant requires clarification, the Office will request confirmation in writing.

The Office will notify the CTM or RCD proprietor and the CTM or CD court that the counterclaim has been entered in the Register. If the request was made by one of the parties to the counterclaim proceedings, the Office will also inform this party.

The entry in the relevant Register will be published in Part C.9.3. of the CTM Bulletin or Part B.3.1 of the RCD Bulletin.

3 Application to Register a Judgment on a Counterclaim Before a CTM or CD court

Article 100(6) CTMR Rule 84(3)(o) CTMIR Article 86(4) CDR Article 69(3)(q) CDIR
--

Where a CTM or CD court has given a judgment, which has become final, on a counterclaim for revocation of a CTM or for invalidity of a CTM or an RCD, a copy of the judgment shall be sent to the Office.

The Office also allows any party to the counterclaim proceedings to request the entry of a judgment on the counterclaim action in the Register, if not yet communicated by the CTM or CD court.

The recordal applicant (the CTM or CD court or one of the parties in the counterclaim proceedings) must indicate and submit:

- a copy of the judgment, together with confirmation from the CTM or CD court that the judgment has become final,
- the date on which the judgment became final,
- the number of the CTM or RCD concerned,
- an indication of whether the request is for revocation or for declaration of invalidity,
- in the event of partial cancellation or invalidity, the list of goods and services affected by the judgment, if relevant.

The Office needs confirmation that the judgment is final (*rechtskräftig/adquirido fuerza de cosa juzgada/passée en force de chose jugée*, etc.). If the Office requires clarification, it will request confirmation in writing.

Where the final judgment partially cancels a CTM, the Office will alter the list of goods and services according to the CTM court judgment and, where necessary, will send the amended list of goods and services for translation.

The Office will notify the CTM or RCD proprietor and the CTM or CD court that the judgment has been entered in the Register. If the request was made by one of the parties to the counterclaim proceedings, the Office will also inform this party.

The entry in the relevant Register will be published in Part C.9.4. of the CTM Bulletin or Part B.3.2. of the RCD Bulletin.

***GUIDELINES FOR EXAMINATION IN THE
OFFICE FOR HARMONIZATION IN THE
INTERNAL MARKET (TRADE MARKS AND
DESIGNS) ON REGISTERED COMMUNITY
DESIGNS***

REGISTERED COMMUNITY DESIGNS

***EXAMINATION OF DESIGN INVALIDITY
APPLICATIONS***

Table of Contents

1	Purpose	5
2	Introduction – General Principles Applying to Invalidation Proceedings	5
2.1	Duty to state reasons	5
2.2	Right to be heard	6
2.3	Scope of the examination carried out by the Invalidation Division.....	6
2.4	Compliance with time limits	7
3	Filing of an Application	8
3.1	Form of the application	8
3.2	Scope of the application	8
3.3	Language of proceedings	8
3.4	Identification of the application.....	9
3.5	<i>Locus standi</i> of the applicant	9
3.6	Representation of the application	10
3.6.1	When representation is mandatory	10
3.6.2	Who may represent	10
3.7	Identification of the contested Community design	10
3.8	Lapsed registrations	11
3.9	Statement of grounds, facts, evidence and arguments	11
3.9.1	Statement of grounds	11
3.9.2	Facts, evidence and arguments	12
3.9.3	Admissibility in respect of one of the grounds relied on	13
3.10	Signing the application	13
3.11	Means of filing	14
3.12	Payment of fees	14
3.13	Treating deficiencies	15
3.14	Communication to the holder	15
3.15	Participation of an alleged infringer	15
4	Adversarial Stage of the Proceedings	16
4.1	Exchange of communications	16
4.1.1	Observations by the holder.....	16
4.1.1.1	Generalities	16
4.1.1.2	Request for proof of use of an earlier trade mark	17
4.1.2	Translation of the holder's observations.....	17
4.1.3	Scope of defence.....	17
4.1.4	Reply by the applicant	18
4.1.4.1	Generalities	18
4.1.4.2	Translation of the applicant's reply	19

4.1.4.3	Submission of evidence of use of an earlier trade mark	19
4.1.5	End of exchange of observations	20
4.1.6	Extension of time limits and suspension	20
4.1.6.1	Extension of time limits	20
4.1.6.2	Suspension	20
4.1.7	Taking of evidence	21
4.1.8	Oral proceedings	22
4.2	Examination	23
4.2.1	Commencement of examination	23
4.2.2	Examination of the grounds for invalidity	23
5	The Different Grounds for Invalidity	24
5.1	Not a design	24
5.1.1	Living Organisms	24
5.1.2	Ideas and methods of use	25
5.2	Lack of entitlement	25
5.3	Technical function	25
5.3.1	Rationale	25
5.3.2	Examination	26
5.3.3	Alternative shapes	27
5.4	Designs of interconnections	27
5.5	Lack of novelty and individual character	27
5.5.1	Disclosure of prior design	27
5.5.1.1	General principles	27
5.5.1.2	Official publications	28
5.5.1.3	Exhibitions and use in trade	29
5.5.1.4	Disclosures derived from the internet	30
5.5.1.5	Statements in writing, sworn or affirmed (affidavits)	31
5.5.1.6	Insufficient disclosure	31
5.5.1.7	Disclosure to a third person under explicit or implicit conditions of confidentiality	32
5.5.1.8	Disclosure within the priority period	32
5.5.1.9	Grace period	33
5.5.2	Assessment of novelty and individual character	33
5.5.2.1	Common principles	34
5.6	Conflict with a prior design right	42
5.7	Use of an earlier distinctive sign	43
5.7.1	Distinctive sign	43
5.7.2	Use in a subsequent design	43
5.7.3	Substantiation of the application under Article 25(1)(e) CDR (earlier distinctive signs)	43
5.7.4	Examination by the Invalidity Division	44
5.8	Unauthorised use of a work protected under the copyright law of a Member State	45
5.8.1	Substantiation of the application under Article 25(1)(f) CDR (earlier copyright)	45
5.8.2	Examination by the Invalidity Division	45
5.9	Partial invalidity	46

5.10	Grounds of invalidity that become applicable merely because of the accession of a new Member State.....	47
6	Termination of the Proceedings.....	47
6.1	Termination of proceedings without a decision on the merits.....	47
6.2	Decision on costs.....	47
6.2.1	Cases where a decision on costs must be taken	47
6.2.2	Cases where a decision on costs is not to be taken	47
6.2.2.1	Agreement on costs	47
6.2.2.2	Apportionment of costs.....	48
6.2.2.3	Fixing of costs	48
6.3	Correction of mistakes and entry in the Register	49
6.3.1	Correction of mistakes.....	49
6.3.2	Entry into the Register	49
7	Appeal.....	50
7.1	Right to appeal	50
7.2	Interlocutory revision.....	50

1 Purpose

The purpose of these Guidelines is to explain how, in practice, the requirements of the Community Design Regulation¹ (CDR), the Community Design Implementing Regulation² (CDIR), and the Fees Regulation³ (CDFR) are applied by the Invalidation Division of OHIM from the receipt of an application for a declaration of invalidity of a Community design ('application') up to the point of closure of the invalidity proceedings. Their purpose is also to ensure consistency among the decisions taken by the Invalidation Division and to ensure coherent practice in the treatment of the files. These Guidelines are not intended to, and cannot, add to or subtract from the legal contents of the Regulations.

2 Introduction – General Principles Applying to Invalidation Proceedings

2.1 Duty to state reasons

The decisions of the Invalidation Division must state the reasons on which they are based (Article 62 CDR). The reasoning must be logical and it must not disclose internal inconsistencies.

The obligation to state reasons has two purposes: to allow interested parties to know the justification for the measure taken so as to enable them to protect their rights and to enable the next instance to exercise its power to review the legality of the decision. Moreover, the obligation to state reasons is an essential procedural requirement, as distinct from the question whether the reasons given are correct, which goes to the substantive legality of the contested measure (judgment of 27/06/2013, T-608/11, Instruments for writing, EU:T:2013:334, § 67-68 and the case-law cited therein).

The Invalidation Division must rule on each head of claim submitted by the parties (judgment of 10/06/2008, T-85/07, Gabel, EU:T:2008:186, § 20). However, the Invalidation Division is not required to give express reasons for its assessment of the value of each argument and each piece of evidence presented to it, in particular where it considers that the argument or evidence in question is unimportant or irrelevant to the outcome of the dispute (see by analogy judgment of 15/06/2000, C-237/98 P, ECLI:EU:C:2000:321, § 51). It is sufficient if the Invalidation Division sets out the facts and legal considerations having decisive importance in the context of the decision (judgment of 12/11/2008, T-7/04, Limoncello, EU:T:2008:481, § 81).

¹ [Council Regulation \(EC\) No 6/2002 of 12 December 2001 on Community Designs](#), by Council Regulation No 1891/2006 of 18 December 2006 amending Regulations (EC) No 6/2002 and (EC) No 40/94 to give effect to the accession of the European Community to the Geneva Act of the Hague Agreement concerning the international registration of industrial designs.

² [Commission Regulation \(EC\) No 2245/2002 of 21 October 2002 implementing Council Regulation \(EC\) No 6/2001 on Community designs](#), as amended by Commission Regulation (EC) No 876/2007 on 24 July 2007 amending Regulation (EC) No 2245/2002 implementing Council Regulation (EC) No 6/2002 on Community designs following the accession of the European Community to the Geneva Act of the Hague Agreement concerning the international registration of industrial designs.

³ [Commission Regulation \(EC\) No 2246/2002 of 16 December 2002 on the fees](#), as amended by Commission Regulation (EC) No 877/2007 of 24 July 2007 amending Regulation (EC) No 2246/2002 concerning the fees payable to the Office for Harmonization in the Internal Market (Trade Marks and Designs) following the accession of the European Community to the Geneva Act of the Hague Agreement concerning the international registration of industrial designs.

Whether the reasoning satisfies those requirements is a question to be assessed with reference not only to its wording, but also to its context and the legal rules governing the matter in question (judgment of 07/02/2007, T-317/05, *Guitar*, EU:T:2007:39, § 57).

The Invalidation Division will apply the principles explained in the Guidelines, Part A, General Rules, Section 2, General Principles to be Respected in the Proceedings, paragraph 1, Adequate reasoning.

2.2 Right to be heard

The decisions of the Invalidation Division will 'be based only on reasons or evidence on which the parties concerned have had an opportunity to present their comments' (Article 62 CDR).

To that end, the Invalidation Division will invite the parties to file observations on communications from the other parties or issued by itself as often as necessary (Article 53(2) CDR).

The right to be heard covers all the factual and legal evidence that form the basis for the act of taking the decision, but it does not apply to the final position that the Invalidation Division intends to adopt (judgment of 20/04/2005, T-273/02, *Calpico*, EU:T:2005:134, § 64-65).

The Invalidation Division may base its analysis on facts arising from practical experience generally acquired from the marketing of general consumer goods that are likely to be known by anyone and are, in particular, known by the informed users of those goods; in such a case the Invalidation Division is not obliged to give examples or evidence of such a practical experience.

The Invalidation Division will apply the principles explained in the Guidelines, Part A, General Rules, Section 2, General Principles to be Respected in the Proceedings, paragraph 2, The right to be heard.

2.3 Scope of the examination carried out by the Invalidation Division

In invalidation proceedings, the examination carried out by the Invalidation Division is restricted to the facts, evidence and arguments provided by the parties (Article 63(1) CDR). However, the Invalidation Division must weigh the facts, evidence and arguments, adjudicate on their conclusiveness, and thereafter draw legal inferences from them without being bound by the points of agreement between the parties. Alleged facts that are not supported by evidence are not taken into account (decision of 22/04/2008, ICD 4 448).

Facts, evidence and arguments are three different items not to be confused with each other. For instance, the date of disclosure of a prior design is a fact. Evidence of that fact could be the date of publication of a catalogue showing the prior design together with evidence proving that the catalogue had been made available to the public before the date of filing or the priority date of the contested Community design. The applicant's argument could be that the prior design forms an obstacle to the novelty of the contested Community design given the similar overall impression they produce on the informed user. Whether a Community design lacks novelty or not is not a fact but a

legal question to be decided by the Invalidity Division on the basis of the facts, evidence and arguments submitted by the parties.

Expert reports or expert opinions and other statements in writing fall within the means of evidence referred to in Article 65(1)(c) and (f) CDR. However, the fact that they are procedurally admissible does not automatically mean that the statement is credible and will serve as proof of the facts to be proven. Rather, such statements must be critically examined as to the accuracy and correctness of the information, as well as whether they come from an independent source and/or are fettered or supported by written information (decision of 22/04/2008, ICD 4 448).

Moreover, the legal criteria for applying a ground for invalidity are naturally part of the matters of law submitted for examination by the Invalidity Division. A matter of law may have to be ruled on by the Invalidity Division, even when it has not been raised by the parties, if it is necessary to resolve that matter in order to ensure a correct application of the CDR. The Invalidity Division will thus examine *ex officio* such matters of law that can be assessed independently of any factual background for the purpose of allowing or dismissing the parties' arguments, even if they have not put forward a view on those matters (see by analogy judgment of 01/02/2005, T-57/03, Hooligan, EU:T:2005:29, § 21). Such matters of law will include, *inter alia*, the definition of the informed user and the degree of freedom of the designer within the meaning of Article 6 CDR.

2.4 Compliance with time limits

The Invalidity Division may disregard facts or evidence that are not submitted in due time by the parties concerned (Article 63(2) CDR).

Parties are reminded that they must file the facts and evidence on which they rely in due time and within the time limits set by the Invalidity Division. Parties that fail to observe the time limits run the risk that the evidence may be disregarded. Parties have no unconditional right to have facts and evidence submitted out of time to be taken into consideration by the Invalidity Division.

Where the Invalidity Division exercises its discretion under Article 63(2) CDR, it must state reasons why the late facts and evidence are admissible or not, taking into consideration whether the material that has been produced late is, on the face of it, likely to be relevant to the outcome of the invalidity proceedings brought before it and, second, whether the stage of the proceedings at which that late submission takes place and the circumstances surrounding it do not argue against such matters being taken into account (judgment of 13/03/2007, C-29/05 P, Arcol, EU:C:2007:162, § 42-44).

Where a party files a submission by fax, it should indicate on the accompanying letter whether a confirmation copy (which, as the case may be, may contain documents in colours) has been sent. Both the fax and the confirmation copy should reach the Office within the time limit set. In accordance with Article 63(2) CDR, the Office may take into account a confirmation copy that was not submitted in due time by the parties concerned.

If the time limit is still running, the party may request an extension of the time limit pursuant to Article 57(1) CDR.

For general information on time limits and continuation of proceedings, see the Guidelines, Part A, General Rules, Section 1, Means of Communication, Time Limits.

As regards incomplete or illegible forms, see paragraph 3.11 below.

However, applicants should be reminded that the one-month time limit, specified under paragraph 3.11 below, only applies to the filing of a request for a declaration of invalidity (for which no time limit is set by the Office), and not to other procedural steps for which the Office sets a time limit.

3 Filing of an Application

3.1 Form of the application

For filing an application (Article 52 CDR) the Office provides a form (Article 68(1)(f) CDIR) that can be downloaded from the Office's website.

The use of the form is strongly recommended (Article 68(6) CDIR), in order to facilitate the processing of the application and to avoid errors.

The application, including the supporting documents, should be submitted in duplicate, in order that one set can be kept in the archive of the Office while the other is sent to the holder without incurring a loss of quality due to copying. If an application is submitted in one set only, the Invalidity Division may invite the applicant to file a second set within a period of one month, or two months if the applicant does not have its domicile or its principal place of business or an establishment within the European Union (Article 57(1) CDIR).

3.2 Scope of the application

In invalidity proceedings, the relief sought by the applicant can only be the declaration of invalidity of the contested Community design as registered (Article 25 CDR).

Where contested Community designs are part of a multiple registration, each of them must be contested individually and identified by reference to their full registration number (Article 37(4) CDR). A single application (and a common statement of grounds) may concern more than one Community design of a multiple registration. In such a case, the fee for the application must be paid for each contested Community design. However, for the sake of clarity the Office recommends that separate applications be lodged for each contested Community design.

3.3 Language of proceedings

The language regime in design invalidity proceedings is not identical to that governing trade mark proceedings.

The language used in filing the application for registering the contested Community design (language of filing) is the language of the invalidity proceedings (language of proceedings), provided the language of filing is one of the five languages of the Office (Article 98 CDR; Article 29 CDIR).

If the language of filing is not one of the five languages of the Office, the language of proceedings is the second language indicated in the application for the contested Community design (Article 98(4) CDR; Article 29(1) CDIR).

The application for a declaration of invalidity must be filed in the language of proceedings. Where the application is not filed in the language of proceedings, the Invalidity Division will notify the applicant requesting it to file a translation within a period of two months from the date of receipt of the notification. Where the applicant does not comply with the request, the application will be rejected as inadmissible (Article 30(1) CDIR).

The parties to the invalidity proceedings may agree on a different language of proceedings provided it is an official language of the European Union. Information as regards the agreement must reach the Office within a period of two months after the holder has been notified of the application. Where the application was not filed in that language, the applicant must file a translation of the application in that language within one month from the date when the Office was informed of the agreement (Article 98(5) CDR; Article 29(6) CDIR).

For the linguistic regime applicable to the supporting documents, see paragraph 3.9.2 below.

3.4 Identification of the application

The application must contain an indication of the name and address of the applicant (Article 28(1)(c) CDIR).

Where the information given in the application does not make it possible to identify the applicant unambiguously, and the deficiency is not remedied within two months of the Invalidity Division's request in that regard, the application must be rejected as inadmissible (Article 30(1) CDIR).

3.5 *Locus standi* of the applicant

Any natural or legal person, as well as a public authority empowered to do so, may submit an application for a declaration of invalidity of a Community design to the Invalidity Division based on Article 25(1)(a) and (b) CDR (Article 52(1) CDR).

However, where the ground for invalidity is the violation of an earlier right, within the meaning of Article 25(1)(c) to (f) CDR, or an improper use of official emblems, within the meaning of Article 25(1)(g) CDR, the admissibility of an application for a declaration of invalidity requires the applicant to be entitled to the earlier right or to be concerned by the use of the official emblem, as the case may be (Article 52(1) CDR). Entitlement will be examined on the basis of the international, national law or the law of the European Union that governs the earlier right or official emblem in question.

For substantiation of the applicant's entitlement, see paragraph 3.9.2 below.

3.6 Representation of the application

3.6.1 When representation is mandatory

As a matter of principle, the rules governing representation in Community trade mark proceedings apply *mutatis mutandis* to invalidity proceedings for Community designs (see the Guidelines, Part A, General Rules, Section 5, Professional Representation).

Persons having their domicile or their principal place of business or a real and effective industrial or commercial establishment in the European Union are not required to be represented in any proceedings before the Office.

Where the applicant does not have its domicile or its principal place of business or a real and effective industrial or commercial establishment in the European Union, it must be represented by a representative, otherwise the applicant will be requested to appoint a representative within a time limit of two months. Where the applicant does not comply with the request, the application will be rejected as inadmissible (Article 77(2) CDR; Article 30(1) and Article 28(1)(c) CDIR).

In examining whether an applicant has a real and effective industrial or commercial establishment in the European Union, the Invalidity Division follows the guidance of the Court of Justice of 22/11/1978, C-33/78, Somafer SA, EU:C:1978:205, § 12 ('The concept of branch, agency or other establishment implies a place of business that has the appearance of permanency, such as the extension of a parent body, has a management and is materially equipped to negotiate business with third parties'). Proof that an applicant has a real and effective industrial or commercial establishment in the European Union may consist inter alia of articles of incorporation, annual reports, statements in writing, and other business documents.

3.6.2 Who may represent

Only a legal practitioner or a professional representative who fulfils the requirements of Article 78(1) CDR can represent third parties before the Office.

A natural or legal person whose domicile, principal place of business, or real and effective industrial or commercial establishment is in the European Union may be represented before the Office by an employee. Employees of such a legal person may also represent another legal person having neither its domicile nor its principal place of business nor a real and effective industrial or commercial establishment within the European Union, provided there exist economic connections between the two legal persons (Article 77(3) CDR).

3.7 Identification of the contested Community design

An application for a declaration of invalidity must contain the registration number of the contested Community design and the name and address of its holder, as entered in the Register (Article 28(1)(a) CDIR).

Where the information given by the applicant does not make it possible to identify the contested Community design unambiguously, the applicant will be requested to supply such information within a period of two months. If the applicant does not comply with this request, the application will be rejected as inadmissible (Article 30(1) CDIR).

3.8 Lapsed registrations

A Community design may be declared invalid even after the Community design has lapsed or has been surrendered (Article 24(2) CDR).

Where the contested Community design has lapsed or has been surrendered on or before the date of filing of the application, the applicant will be requested to submit evidence, within a period of two months, that it has a legal interest in the declaration of invalidity. Where the applicant does not comply with the request, the application is rejected as inadmissible (Article 30(1) CDIR) (decision of 16/06/2011, ICD 8 231).

For instance, legal interest is established where the applicant proves that the holder of the contested Community design has taken steps with the view to invoke rights under the contested Community design against it.

Where the contested Community design has lapsed or has been surrendered in the course of the invalidity proceedings, the applicant will be asked to confirm whether it maintains its application within a period of two months and, if so, to submit reasons in support of its request to obtain a decision on the merits of the case.

3.9 Statement of grounds, facts, evidence and arguments

The application must include an indication of the grounds on which the application is based (Article 52(2) CDR; Article 28(1)(b)(i) CDIR) together with a reasoned statement stating the facts, evidence and arguments in support of those grounds (Article 28(1)(b)(vi) CDIR).

3.9.1 Statement of grounds

Where the applicant uses the form provided by the Office (Article 68(1)(f) CDIR), the indication of the grounds relied on is made by ticking one or several boxes in the field 'Grounds'. The Invalidation Division will examine an application in the light of all grounds put forward in the reasoned statement of grounds, even if the corresponding boxes in the form used to lodge the action were not ticked.

Where the applicant does not use the form provided by the Office, an indication of the relevant subsection of Article 25(1) CDR, such as 'ground of Article 25(1)(a) CDR', is sufficient to establish admissibility of the application in respect of the statement of grounds.

Where the application does not make it possible to identify unambiguously the ground(s) on which the application is based, the applicant will be requested to provide further specifications in this respect within a period of two months. Where the applicant does not comply with the request, the application will be rejected as inadmissible (Article 30(1) CDIR).

Grounds for invalidity other than those specifically relied on in the application will be considered inadmissible when subsequently put forward before the Invalidation Division.

The Office strongly recommends that all grounds for invalidity be put forward in one single application. Where separate applications are lodged against the same contested Community design and based on different grounds, the Invalidity Division may deal with them in one set of proceedings. The Invalidity Division may subsequently decide no longer to deal with them in this way (Article 32(1) CDIR).

3.9.2 Facts, evidence and arguments

The applicant must indicate the facts, evidence and arguments in support of the ground(s) on which the application is based (Article 28(1)(b)(vi) CDIR).

Where the applicant claims that the contested Community design lacks novelty or individual character (Article 25(1)(b) CDR), the application must contain a representation of the prior design(s) that could form an obstacle to the novelty or individual character of the contested Community design, as well as documents proving the disclosure of the prior design(s) (Article 7 CDR; Article 28(1)(b)(v) CDIR).

Where the applicant claims that the holder is not entitled to the contested Community design (Article 25(1)(c) CDR), the application must contain particulars showing that the applicant is entitled to the contested Community design by virtue of a court decision (Article 28(1)(c)(iii) CDIR).

Where the applicant claims that the contested Community design is in conflict with a prior design (Article 25(1)(d) CDR), the application must contain a representation and particulars identifying the prior design. Furthermore, the application must contain evidence proving that the applicant is the holder of the prior design as a ground for invalidity (Article 28(1)(b)(ii) CDIR).

Where the applicant claims that the contested Community design violates an earlier right, namely that it makes unauthorised use of a distinctive sign (Article 25(1)(e) CDR) or a work protected by copyright in a Member State (Article 25(1)(f) CDR), the application must contain a representation and particulars identifying the distinctive sign or the work protected by copyright. Furthermore, the application must contain evidence proving that the applicant is the holder of the earlier right in question (Article 28(1)(b)(iii) CDIR).

Where the earlier right is *registered*, a distinction is made depending on whether the earlier design or trade mark is a RCD or a CTM. If the earlier right is a RCD or a CTM, the applicant does not have to submit any documents. The examination of the substantiation will be done for the data contained in the database of the Office. In all other cases, the applicant must provide the Office with evidence of the filing and registration of the earlier design or registered distinctive sign. The following documents will be accepted to substantiate the existence of an earlier design: (1) certificates issued by the appropriate official body, (2) extracts from official databases (see the Guidelines, Part C, Opposition, Section 1, Procedural Matters, paragraph 4.2.3.2, Extracts from official databases), (3) extracts from official bulletins of the relevant national offices and WIPO.

Where the earlier right is *unregistered*, this condition will be considered to be complied with for the purpose of examining the admissibility of the application, where the applicant submits evidence that the earlier distinctive sign or the earlier work protected by copyright law has been used or disclosed, as the case may be, under the applicant's name before the date of filing or the priority date of the Community design (see

paragraphs 5.7.3 and 5.8.1 below for substantiation of the proprietorship of the earlier right relied on under Article 25(1)(e) and (f) CDR).

Where the applicant claims that the contested Community design makes improper use of any of the items listed in Article 6ter of the Paris Convention or of badges, emblems and escutcheons other than those covered by Article 6ter and which are of particular interest in a Member State (Article 25(1)(g) CDR), the application must contain a representation and particulars of the relevant item and particulars showing that the application is filed by the person or entity concerned by the improper use (Article 28(1)(b)(iv) CDIR).

Where the indications required above are missing, and the deficiency is not remedied by the applicant within a period of two months following a request of the Invalidation Division, the application will be rejected as inadmissible (Article 30(1) CDIR).

Where the evidence in support of the application is not filed in the language of proceedings, the applicant must on its own motion submit a translation of that evidence into that language within two months of the filing of such evidence (Article 29(5) CDIR). The question of whether certain parts of the supporting documents may be considered irrelevant for the application, and therefore not translated, is a matter for the discretion of the applicant. In cases where a translation is not submitted, the Invalidation Division will disregard the text portions of the evidence that are not translated and base its decision solely on the evidence before it that has been translated into the language of proceedings (Article 31(2) CDIR).

Documents in support of an application should be listed in a schedule of annexes appended to the application itself. As best practice, the schedule of annexes should indicate, for each document annexed, the number of the annex (Annex A.1, A.2, etc.), a short description of the document (e.g. 'letter') followed by its date, the author(s) and the number of pages, and the page reference and paragraph number in the pleading where the document is mentioned and its relevance is described.

The documents annexed to a pleading must be paginated. This is to ensure that all pages of the annexes have been duly scanned and communicated to the other parties.

3.9.3 Admissibility in respect of one of the grounds relied on

An application based on more than one ground of invalidity is admissible if the requirements regarding admissibility are satisfied for at least one of these grounds.

3.10 Signing the application

The application for a declaration of invalidity must be signed by the applicant or its representative if it has one (Article 65(1) CDIR).

Where the signature is missing, the Invalidation Division will request the applicant to remedy the deficiency within two months. If the applicant does not comply with the request, the application will be rejected as inadmissible (Article 30(1) CDIR).

3.11 Means of filing

An application for a declaration of invalidity may be filed with the Office by post, personal delivery, or fax (Article 65 CDIR). Electronic filing of applications will be allowed by a subsequent decision of the President once the technical means are available.

Where a communication received by fax is incomplete or illegible, or where the Invalidity Division has reasonable doubts as to the accuracy of the transmission, the Invalidity Division will inform the sender accordingly and will call upon him/her, within a time limit to be specified by the Invalidity Division, to retransmit the original by fax or to submit the original. Where that request is complied with within the time limit specified, the date of the receipt of the retransmission or of the original will be deemed to be the date of the receipt of the original communication. Where the request is not complied with within the time limit specified, the communication will be deemed not to have been received (Article 66(2) CDIR).

Transmission by fax is not recommended for applications for a declaration of invalidity, in particular where lack of novelty and/or lack of individual character are claimed, because the quality of the representation of the prior design(s) may be deteriorated by fax transmission and colour information will be lost.

Where an application is transmitted by fax, the Office recommends that the applicant submits two sets of the original within one month from the date of transmission of the fax. The Invalidity Division will then forward one set to the holder. Where the applicant does not subsequently submit original documents after a fax transmission, the Invalidity Division will proceed with the documents before it.

It is the applicant's responsibility to ensure that the features of earlier designs or other rights, as they appear in the fax received by the Invalidity Division, are sufficiently visible and identifiable in order for the Invalidity Division to make its decision. An application will be dismissed as unsubstantiated if the faxed evidence of the prior designs, or of the earlier rights, without being totally illegible, is not of a sufficient quality allowing all the details to be discerned with a view to a comparison with the contested Community design (decision of 10/03/2008, R 0586/2007-3, Barbecues, § 23-26).

3.12 Payment of fees

The application for a declaration of invalidity will be deemed not to have been filed until the fee has been paid in full (Article 52(2) CDR; Articles 28(2) and 30(2) CDIR).

The methods of payment are via transfer to a bank account held by the Office (Article 5(1) CDFR) or, for current account holders, via current account. In the case of payment via a current account, the fee will be debited automatically from the applicant's current account upon receipt of the application. The date on which the amount of the payment is actually credited to the bank account of the Office will be considered to be the date of payment (Article 7(1) CDFR).

See the Guidelines, Part A, General Rules, Section 3, Payment of Fees, Costs and Charges for further reference.

Payment cannot be made by cheque.

Where the Invalidation Division finds that the fee has not been paid, it will notify the applicant requesting him/her to pay the fee within a period of two months after receipt of the notification. If the applicant does not comply with the request, the application is deemed not to have been filed and the applicant is informed accordingly. If the required fee is paid after the expiry of the time limit specified, it will be refunded to the applicant (Article 30(2) CDIR).

The date of payment of the fee determines the date of filing of the application of a declaration of invalidity (Article 52(2) CDR; Article 30(2) CDIR).

3.13 Treating deficiencies

Where the Invalidation Division finds the application inadmissible and the deficiency is not remedied within the specified time limit, the Invalidation Division will issue a decision rejecting the application as inadmissible (Article 30(1) CDIR). The fee will not be refunded.

3.14 Communication to the holder

The communication of an application for a declaration of invalidity to the RCD holder takes place only after this application has been found admissible (Article 31(1) CDIR). This communication constitutes as such a decision on the admissibility, rather than a simple measure of organisation of procedure. This decision can be appealed together with the final decision (Article 55(2) CDR).

The decision on admissibility may, however, be withdrawn, in accordance with the general principles of administrative and procedural law, if irregularities are detected ex officio by the Office, within a reasonable time, or by the RCD holder in its first observations (Article 31(1) CDIR), and if the applicant for invalidity fails to remedy such irregularities within the time limit prescribed by the Office (Article 30 CDIR) (see Article 68 CDR and, by analogy, judgment of 18/10/2012, C-402/11 P, Redtube, EU:C:2012:3835, § 59).

Where the Invalidation Division does not reject the application as inadmissible, the application is communicated to the holder and a time limit of two months for submitting observations in response to the application is notified (see below under paragraph 4.1.1, Observations by the holder).

3.15 Participation of an alleged infringer

As long as no final decision has been taken by the Invalidation Division, any third party that proves that proceedings for infringement based on the contested Community design have been instituted against it can join as a party in the invalidity proceedings (Article 54 CDR; Article 33 CDIR).

The alleged infringer must file its request to be joined as a party within three months of the date on which the infringement proceedings were instituted. Unless proof is submitted by the holder that another date should be retained according to the national law in question, the Invalidation Division will assume that proceedings are 'instituted' on

the date of service of the action to the alleged infringer. The alleged infringer must submit evidence in respect of the date of service of the action.

Any third party who proves that (i) the right holder of the Community design has requested that it cease an alleged infringement of the design and that (ii) the third party in question has instituted proceedings for a court ruling that it is not infringing the registered Community design (if actions for declaration of non-infringement of Community designs are permitted under national law) may also join as a party in the invalidity proceedings (Article 54 and Article 81(b) CDR).

The request to be joined as a party must be filed in a written reasoned statement and it will not be deemed to have been filed until the invalidity fee has been paid. The rules explained above in paragraphs 3.1 to 3.13 will apply to the alleged infringer (Article 54(2) CDR; Article 33 CDIR).

4 Adversarial Stage of the Proceedings

4.1 Exchange of communications

4.1.1 Observations by the holder

As a matter of principle, the rules governing representation in Community trade marks proceedings apply *mutatis mutandis* to invalidity proceedings for Community designs (see the Guidelines, Part A, General Rules, Section 5, Professional Representation).

When representation is mandatory and the holder is no longer represented, the Invalidity Division will invite the holder to appoint a representative. If the holder does not do so, procedural statements made by the holder will not be taken into account, and the invalidity request will be dealt with on the basis of the evidence that the Invalidity Division has before it.

4.1.1.1 Generalities

The holder's observations will be communicated to the applicant without delay (Article 31(3) CDIR).

Documents in support of observations should be listed in a schedule of annexes (see paragraph 3.9.2 above).

The holder should submit its observations (including the supporting documents) in duplicate, so that one set can be kept in the archive of the Office and the other sent to the applicant. This is done to avoid a loss of quality in the observations material due to copying by the Office. Where the observations are submitted in one set only, the Invalidity Division may invite the holder to file a second set within a period of one month, or two months if the applicant does not have its domicile or its principal place of business or an establishment within the European Union (Article 57(1) CDIR).

Where the holder files no observations within the two-month time limit, the Invalidity Division will notify the parties that the written phase of the proceedings is closed and that it will take a decision on the merits on the basis of the evidence before it (Article 31(2) CDIR).

4.1.1.2 Request for proof of use of an earlier trade mark

A request for proof of use of an earlier trade mark during the period of five years preceding the date of the application for a declaration of invalidity may be submitted by the holder if the following cumulative conditions are complied with:

- the application is based on Article 25(1)(e) CDR;
- the earlier distinctive sign is a (Community, international or national) trade mark having effect in the European Union which, on the date of the application for a declaration of invalidity, has been registered for not less than five years;
- the request for proof of use is submitted together with the holder's first submission in response to the application (judgments of 12/05/2010, T-148/08, Instruments for writing, EU:T:2010:190, § 66-72; 27/06/2013, T-608/11, Instruments for writing, EU:T:2013:334, § 87. See also decision of 15/11/2013, R 1386/2012-3, Cinturones, § 21).

'The date of the completion of the registration procedure' (Article 10(1) of Directive 2008/95/EC) that serves to calculate the starting point for the obligation of use for national and international registrations is determined by each Member State according to their own procedural rules (judgment of 14/06/2007, C-246/05, *Le Chef de Cuisine*, EU:C:2007:340, § 26-28). As regards Community trade marks, that date is the date of registration (Article 15(1) of Council Regulation (EC) No 207/2009 of 26 February 2009 on the Community trade mark, hereafter 'CTMR') as published in the Community Trade Marks Bulletin (Rule 23(5) of Commission Regulation 2868/95 implementing the CTMR, hereafter 'CTMIR'). As regards international registrations designating the European Union, the relevant date is that of the second publication pursuant to Article 152(2) and Article 160 CTMR.

4.1.2 Translation of the holder's observations

Where the language of proceedings is not the language of filing of the contested Community design, the holder may submit its observations in the language of filing (Article 98(4) CDR; Article 29(2) CDIR). The Invalidity Division will arrange to have those observations translated into the language of proceedings, free of charge, and will communicate the translation to the applicant without delay.

4.1.3 Scope of defence

The holder's observations must include an indication regarding the extent to which it defends the contested Community design. Where the holder does not give such an indication, it is assumed that it seeks maintenance of the Community design in the form as originally registered, i.e. in its entirety.

Where the holder requests to maintain the Community design in an amended form, its request must include the amended form. The amended form must comply with the requirements for protection, and the identity of the Community design must be retained. 'Maintenance' in an amended form may include registration accompanied by a partial disclaimer by the holder or entry in the Register of a court decision or a decision by the

Invalidation Division declaring the partial invalidity of the Community design (Article 25(6) CDR) (see paragraph 5.9 below).

The request to maintain the contested Community design in amended form must be submitted during the invalidity proceedings and before the end of the written phase. The applicant will be given the opportunity to comment on whether the Community design in its amended form complies with the requirements for protection and whether the identity of the Community design is retained. The decision on the maintenance of the Community design in an amended form will be included in the decision on the merits terminating the invalidity proceedings.

4.1.4 Reply by the applicant

4.1.4.1 Generalities

Where the parties' submissions allow the Invalidation Division to base its decision on the evidence before it, the Invalidation Division will notify the parties that the written phase of the proceedings is closed.

However, the applicant will be allowed to reply to the holder's observations within a time limit of two months (Article 53(2) CDR; Article 31(3) CDIR) in the following circumstances:

- where the holder's observations contain new facts, evidence and arguments that are *prima facie* relevant for a decision on the merits; or
- where the holder requests to maintain the Community design in an amended form; or
- where the holder requested proof of use of the earlier trade mark relied on under Article 25(1)(e) CDR.

Any reply from the applicant will be communicated to the holder (Article 31(4) CDIR). Where the applicant's reply is considered admissible, the holder will be invited to submit a rejoinder (Article 53(2) CDR).

Where the applicant does not reply within the specified time limit, the Invalidation Division will notify the parties that the written phase of the proceedings is closed and that it will take a decision on the merits on the basis of the evidence before it (Article 31(2) CDIR).

The subject matter of the proceedings must be defined in the application (see paragraphs 3.9 above). Reliance on additional earlier designs and/or rights is inadmissible when submitted at the belated procedural stage of the reply if the effect is to alter the subject matter of the proceedings (decision of 22/10/2009, R 0690/2007-3, Chaff cutters, § 44 et seq.). The admissibility of additional facts, evidence and arguments relating to earlier designs and/or rights already referred to in the application is subject to the discretionary powers conferred on the Invalidation Division under Article 63(2) CDR (see paragraph 2.4 above).

The applicant should submit its reply in duplicate, so that one set can be kept in the archive of the Office and the other can be sent to the holder. This is done to avoid a loss of quality due to copying. If a reply is submitted in one set only, the Invalidation Division may invite the applicant to file a second set within a period of one month, or

two months if the applicant does not have its domicile or its principal place of business or an establishment within the European Union (Article 57(1) CDIR).

4.1.4.2 Translation of the applicant's reply

Any reply of the applicant must be in the language of proceedings. Where the applicant has been invited to reply and its reply is not in the language of proceedings, the applicant must submit, on its own motion, a translation of its reply within one month of the date of the submission of the original reply (Article 81(1) CDIR). The Invalidity Division will not remind the applicant of its duty in this respect. Where the applicant submits the translation on time, it will be communicated to the holder. Where the applicant does not submit the translation on time, its reply will be deemed not to have been filed.

4.1.4.3 Submission of evidence of use of an earlier trade mark

Where the applicant is requested to submit evidence of use of its earlier trade mark, it must submit such evidence (i) in connection with the goods or services in respect of which this trade mark is registered, and which the applicant cites as justification for its application and (ii) in respect of the period of five years preceding the date of the application for a declaration of invalidity, unless there are proper reasons for non-use. Such reasons for non-use must be substantiated.

Evidence of use of an earlier mark must fulfil *all* the cumulative conditions imposed by Rule 22(3) CTMIR, that is, indications concerning the *place, time, extent and nature* of use of the earlier trade mark for the goods and services for which it is registered and on which the application is based.

Use of the trade mark in a form differing in elements that do not alter the distinctive character of the mark in the form in which it was registered is admissible (Article 5(C)2 of the Paris Convention).

Where the language of the documents submitted by the applicant is not the language of the proceedings, the Invalidity Division may require that a translation be supplied in that language, within one month, or two months if the applicant does not have its domicile or its principal place of business or an establishment within the European Union (Articles 81(2) and 57(1) CDIR).

In the absence of proof of genuine use of the earlier trade mark (unless there are proper reasons for non-use), or in the absence of a translation if so required by the Invalidity Division, the application for a declaration of invalidity will be rejected to the extent that it was based on Article 25(1)(e) CDR. If the earlier trade mark has been used in relation to only a part of the goods or services for which it is registered, it will, for the purpose of the examination of the application for a declaration of invalidity, be deemed to be registered in respect of only that part of the goods or services (see by analogy Articles 57(2) and (3) CTMR).

When examining the evidence of use, the Invalidity Division will apply the principles explained in the Guidelines, Part C, Opposition, Section 6, Proof of Use.

4.1.5 End of exchange of observations

Where the parties' observations do not contain new facts, evidence or arguments that are *prima facie* relevant for a decision on the merits, the Invalidation Division will inform both parties that the written proceedings are closed and that a decision will be taken on the basis of the evidence before it (Article 53(2) CDR).

Facts, evidence or arguments submitted after notification to the parties that the written phase of the procedure is closed will be considered inadmissible, save in exceptional circumstances, for example, where the evidence was unavailable at an earlier stage or where a fact came to light in the course of the proceedings (Article 63(2) CDR, see paragraph 2.4 above).

4.1.6 Extension of time limits and suspension

4.1.6.1 Extension of time limits

Requests for an extension of a time limit by any of the parties have to be made before its expiry (Article 57(1) CDR).

As a general rule, a first request for extension of a time limit will be granted. Further extensions will not automatically be granted. In particular, the Invalidation Division may make the extension of a time limit subject to the agreement of the other party or parties to the proceedings (Article 57(2) CDR).

Reasons in support of any further request for extension must be submitted to the Invalidation Division. The request for an extension of the time limit must indicate the reasons why the *parties* cannot meet the deadline. The obstacles faced by the parties' *representatives* do not justify an extension (see, by analogy, order of 05/03/2009, C-90/08 P, *Corpo livre*, EU:C:2009:135, § 20-23).

The extension will not result in a time limit longer than six months (Article 57(1) CDR). Both parties are informed about any extension.

4.1.6.2 Suspension

The Invalidation Division will suspend the proceedings on its own motion after hearing the parties, unless there are special grounds for continuing the proceedings, where it has been brought to the attention of the Invalidation Division that the validity of the contested Community design is already in issue on account of a counterclaim before a competent national court and the national court does not stay its proceedings (Article 91(2) CDR).

The Invalidation Division may suspend the proceedings when it is appropriate in the circumstances, in particular:

- where the request for a declaration of invalidity is based on an earlier design or trade mark for which the registration process is pending, until a final decision is taken in those proceedings (Article 25(1)(d) and (e) CDR);
- where the request for a declaration of invalidity is based on an earlier design or trade mark, the validity of which is challenged in administrative or in court proceedings, until a final decision is taken in those proceedings;

- where the Invalidation Division receives a joint request for suspension signed by both parties with a view to reaching an amicable settlement (Article 31(5) CDR);
- where a number of applications for a declaration of invalidity have been filed relating to the same Community design, and where a preliminary examination reveals that the Community design may be invalid on the basis of one of these applications. The Invalidation Division will deal with this application first and it may suspend the other invalidation proceedings (Article 32(2) CDR).

The Invalidation Division has broad discretionary powers when deciding on the appropriateness of the suspension. The decision on the suspension must take into account the balance between the parties' respective interests, including the applicant's interest to obtain a decision within a reasonable period of time (see by analogy, judgment of 16/05/2011, T-145/08, Atlas, EU:T:2011:213, § 68-77).

The Invalidation Division will notify the parties of its decision to grant or refuse a suspension. Where a suspension is granted for a determined period, the Invalidation Division will indicate in its communication the date of resumption of the proceedings. The proceedings will resume the day after the expiry of the suspension. Where the Invalidation Division decides not to grant the suspension, reasons are given in support of this decision, either at the time of refusing the suspension or in the decision terminating the proceedings.

Where a suspension is granted for an undetermined period, the invalidation proceedings will be resumed when the parties inform the Invalidation Division that the event that justified the stay has occurred, or ceased to exist, as the case may be. The date of resumption will be indicated in the communication of the Invalidation Division or, in the absence of such indication, on the day following the date of that communication.

Where a time limit was running at the time of the suspension, the party concerned will be given two months from the date of resumption of the proceedings to submit its observations.

Where the suspension was requested jointly by the parties, the period will always be one year regardless of the period requested by the parties. Any party can bring an end to the suspension ('opting out'). It is immaterial whether the other party disagrees with this or has consented to it.

If one of the parties opts out, the suspension will end two weeks after informing the parties thereof. The proceedings will resume the day after. Where a time limit was running at the time of the suspension, the party concerned will be given two months from the date of resumption of the proceedings to submit its observations.

4.1.7 Taking of evidence

The parties may submit evidence in the form of documents and items of evidence, opinions by experts and witnesses, and/or statements in writing, sworn or affirmed or having a similar effect under the law of the State in which the statement is drawn up (Article 65(1) CDR).

Where a party offers evidence in the form of witness statements or expert opinions, the Invalidation Division will invite the party to provide the statement of the witness or the

opinion of the expert in writing, except where a hearing is considered expedient (Article 65 CDR; Articles 43 and 46 CDIR).

4.1.8 Oral proceedings

Oral proceedings may be held at the request of the Invalidation Division or of any of the parties (Article 64 CDR; Article 38(1) and Article 42 CDIR).

Where a party requests that they be held, the Invalidation Division enjoys broad discretionary powers as to whether oral proceedings are really necessary. A hearing will not be held when the Invalidation Division has before it all the information needed as a basis for the operative part of the decision on invalidity (decision of 13/05/2008, R 0135/2007-3, Automatic machines for games, § 14).

Where the Invalidation Division has decided to hold oral proceedings and to summon the parties, the period of notice may not be less than one month unless the parties agree to a shorter period.

Since the purpose of any oral proceedings is to clarify all points remaining to be settled before a decision on the merits is taken, it is appropriate that the Invalidation Division, in its summons, should draw the attention of the parties to the points that in its opinion need to be discussed. Insofar as the Invalidation Division considers that certain matters require it, and to facilitate the hearing, it may invite the parties to submit written observations or to produce evidence prior to the oral hearing. The period fixed by the Invalidation Division for the receipt of these observations will take account of the fact that these must reach the Invalidation Division within a reasonable period of time to enable them to be submitted to the other parties.

The parties may likewise produce evidence in support of their arguments on their own initiative. However, should such evidence have been produced at an earlier stage of the proceedings, the Invalidation Division will be the sole judge of the admissibility of these items of evidence, complying with the principle of hearing both parties where appropriate.

Oral proceedings, including delivery of the decision, are public, provided the contested Community design has been published, unless the admission of the public could entail a serious and unjustified disadvantage, in particular for a party to the proceedings. The parties are informed accordingly in the summons.

The parties will be provided with a copy of the minutes that contain the essentials of the oral proceedings and the relevant statements made by the parties (Article 46 CDIR).

The Invalidation Division will apply the principles explained in the Guidelines, Part A, General Rules, Section 2, General Principles to be Respected in the Proceedings, paragraph 5, Oral proceedings.

4.2 Examination

4.2.1 Commencement of examination

The Invalidation Division begins with the examination of the application as soon as the parties are informed that the written phase of the procedure is closed and that no further observations can be submitted (Article 53 CDR).

4.2.2 Examination of the grounds for invalidity

The grounds for declaring a Community design invalid are listed exhaustively in Article 25 CDR. An application for a declaration of invalidity based on a ground other than those listed in the CDR (e.g. a claim that the holder was acting in bad faith when applying for the registered Community design) will be rejected as inadmissible as far as the ground in question is concerned (judgment of 18/03/2010, T-9/07, Metal rappers, EU:T:2010:96, § 30-31).

More than one ground may be relied on in the application without entailing additional fees. Where the applicant uses the form supplied by the Office, it must tick the box corresponding to the ground(s) on which the application is based.

Each ground must be supported by its own set of facts, evidence and arguments.

Article 25(1)(b) CDR includes several grounds, namely the ground of failure to meet the requirements of Article 4 CDR (novelty, individual character and visibility of component parts of complex products), the grounds of Article 8(1) and (2) CDR (functionality and designs of interconnections), and the ground of Article 9 CDR (contrary to public policy or morality).

Where the 'Grounds' box in the application form corresponding to Article 25(1)(b) CDR is ticked, the Invalidation Division will determine which specific ground(s) are relied on by the applicant from the facts, evidence and arguments referred to in the reasoned statement of grounds, and will limit the scope of its examination of the application accordingly (decision of 17/04/2008, R 0976/2007-3, Radiators for heating, § 26).

The same applies to the 'Grounds' box in the application form corresponding to Article 25(1)(c), (d), (e), (f) or (g) CDR.

The Invalidation Division must examine an application in the light of all grounds put forward in the original statement of grounds, even if the corresponding boxes in the application form were not ticked. Therefore, where the applicant indicated in the statement of grounds that the contested Community design was 'not novel', that indication constitutes a valid statement of grounds even if the 'Grounds' box concerning the requirements of Articles 4 to 9 CDR was not ticked (decision of 02/08/2007, R 1456/06-3, Saucepan handle, § 10).

Where an applicant expressly challenges the novelty of a Community design and provides evidence of an earlier disclosure, it is assumed that it seeks a declaration of invalidity on the ground of Article 25(1)(b) CDR in conjunction with Article 4 CDR. Therefore, the Invalidation Division will also examine the individual character of the contested Community design (decision of 22/11/2006, R 0196/2006-3, Underwater motive device). Accordingly, if the applicant bases its application on a lack of individual

character, the Invalidation Division may examine the novelty of the contested Community design.

The applicant cannot raise new grounds for invalidity after the date of filing of the application. However, the applicant may file another application for a declaration of invalidity based on different grounds.

Where the application can be upheld on the basis of one of several grounds put forward by the applicant, the Invalidation Division will not take a decision on the others (decision of 15/12/2004, ICD 321). Where an application can be upheld on account of the existence of one of the earlier designs or rights relied on by the applicant, the remaining earlier designs or rights will not be examined (see by analogy judgment of 16/09/2004, T-342/02, Moser Grupo Media, S.L., EU:T:2004:268 and order of 11/05/2006, T-194/05, Teletel International, EU:T:2006:124).

5 The Different Grounds for Invalidation

5.1 Not a design

According to Article 25(1)(a) CDR, a Community design may be declared invalid if the design does not correspond to the definition under Article 3(a) CDR. This would be the case where the views of the Community design are inconsistent and represent different products (other than forming a 'set of products', see Article 3 CDR and the Guidelines, Examination of Applications for Registered Community Designs, Additional requirements regarding the reproduction of the design, paragraph 5.2.3, Sets of articles), or where the graphical representation consists of mere representations of nature (landscapes, fruits, animals etc.) that are not products within the meaning of Article 3(1)(b) CDR.

5.1.1. Living Organisms

A design that discloses the appearance of a living organism in its natural state, in principle, has to be refused. Even if the shape at issue deviates from that of the common corresponding living organism, the design should be refused if nothing suggests *prima facie* that the shape is the result of a manual or industrial process (see by analogy decision of 18/02/2013, R 0595/2012-3, Groente en fruit, § 11).



Community design No 1 943 283-0001 for 'Groente en fruit' (3rd Board of Appeal, decision of 18/02/2013, R 0595/2012-3)

A Community design will not be declared invalid if it is apparent from the representation that the product does not show a living organism or if the indication of the product specifies that this product is artificial (see in particular Class 11-04 of the Locarno Classification).

5.1.2. Ideas and methods of use

The law relating to designs protects the appearance of the whole or a part of a product, but does not protect the underlying idea of a design (judgment of 06/06/2013, T-68/11, Watch-dials, EU:T:2013:298, § 72). Nor is the method of use or operation protected by a design (judgment of 21/11/2013, T-337/12, Sacacorchos, EU:T:2013:601, § 52).

5.2 Lack of entitlement

According to Article 25(1)(c) CDR, a Community design may be declared invalid if, by virtue of a court decision, the right holder is not entitled to the Community design under Article 14 CDR.

It is clear from the words ‘by virtue of a court decision’ in Article 25(1)(c) CDR that the Invalidation Division has no jurisdiction to determine who is entitled to a Community design under Article 14 CDR. Such jurisdiction belongs to any national court that is competent under Article 27, Articles 79(1) and (4) CDR in conjunction with Article 93 CDR. In the absence of a court decision, the Invalidation Division cannot declare the contested Community design invalid under Article 25(1)(c) CDR (decision of 11/02/2008, R 0064/2007-3, Loudspeaker, § 15).

Article 15(1) CDR, which deals with claims to become recognised as the legitimate holder of a Community design, is also irrelevant in relation to the ground of Article 25(1)(c) CDR.

Such a claim falls within the category of ‘actions relating to Community designs other than those referred to in Article 81 CDR’ and therefore lies within the jurisdiction of a national court under Article 93(1) CDR rather than within the competence of the Invalidation Division. This is confirmed by the wording of Article 27(3) CDR, which refers to such a claim being ‘brought before a court’.

5.3 Technical function

Article 8(1) CDR provides that ‘a Community design shall not subsist in features of appearance of a product that are solely dictated by its technical function’.

5.3.1 Rationale

‘Article 8(1) CDR denies protection to those features of a product’s appearance that were chosen exclusively for the purpose of allowing a product to perform its function, as opposed to features that were chosen, at least to some degree, for the purpose of enhancing the product’s visual appearance’, as was held by the 3rd Board of Appeal (decision of 22/10/2009, R 0690/2007-3, Chaff cutters, § 35 et seq.).

The fact that a particular feature of a product’s appearance is denied protection by Article 8(1) CDR does not mean that the whole design must be declared invalid, pursuant to Article 25(1)(b) CDR. The design as a whole will be invalid only if *all the essential features* of the appearance of the product in question were solely dictated by its technical function (decision of 29/04/2010, R 0211/2008-3, Fluid distribution equipment, § 36).

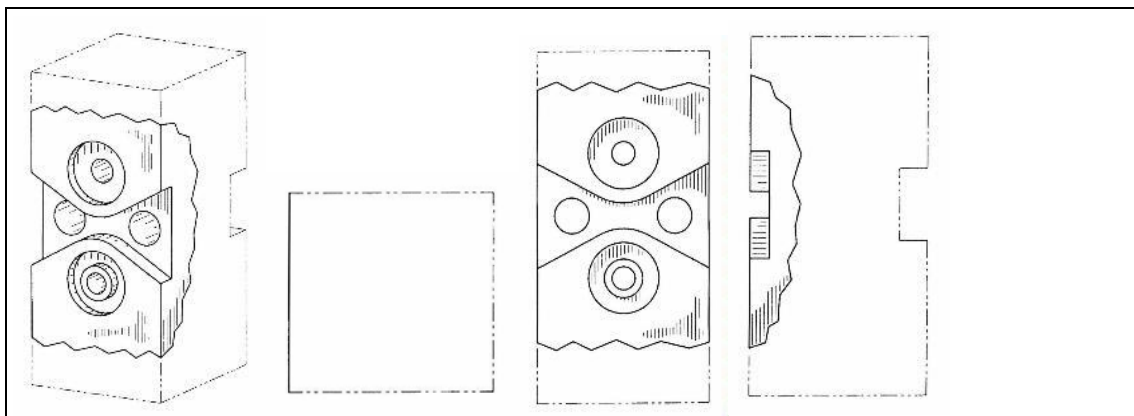

Community design No 232996-0008 for 'Fluid distribution equipment' (3rd Board of Appeal, decision of 29/04/2010, R 0211/2008-3)

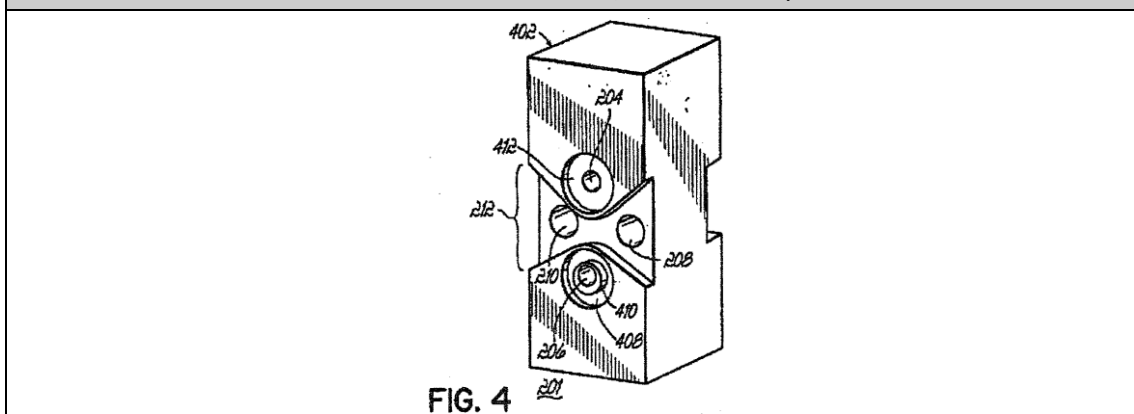

FIG. 4

Drawing taken from the earlier European patent application (EP 1 568 418 A2) for a 'method and system for supporting and/or aligning components of a liquid dispensing system'

5.3.2 Examination

In order to determine whether the essential features of the appearance of the product into which the contested Community design will be incorporated are solely dictated by the technical function of the product, it is first necessary to determine what the technical function of that product is. The relevant indication in the application for registration of the design (Article 36(2) CDR) should be taken into account, but also the design itself, insofar as it makes clear the nature of the product, its intended purpose or its function (see by analogy, judgment of 18/03/2010, T-9/07, Metal rappers, EU:T:2010:96, § 56).

Whether Article 8(1) CDR applies must be assessed objectively, not in the perception of the informed user who may have limited knowledge of technical matters.

The technical functionality of the features of a design may be assessed, inter alia, by taking account of the documents relating to patents describing the functional elements of the shape concerned.

Depending on the case, and in particular in view of its degree of difficulty, the Invalidation Division may appoint an expert (Article 65(3) CDR and Article 44 CDIR).

The Invalidation Division will apply the principles explained in the Guidelines, Part A, General Rules, Section 2, General Principles to be Respected in Proceedings, paragraph 4.3, Commissioning of experts.

5.3.3 Alternative shapes

Article 8(1) CDR does not require that a given feature must be the only means by which the product's technical function can be achieved. Article 8(1) CDR applies where the need to achieve the product's technical function was the only relevant factor when the feature in question was selected (decisions of 22/10/2009, R 0690/2007-3, Chaff cutters, § 31-32; 10/06/2013, R 2466/2011-3, Blades, § 15-16).

The examination of Article 8(1) CDR must be carried out by analysing the Community design, and not designs consisting of other shapes.

5.4 Designs of interconnections

Features of a Community design are excluded from protection if they must necessarily be reproduced in their exact form and dimensions, in order to permit the product in which the design is incorporated or to which it is applied to be mechanically connected to, or placed in, around or against another product so that either product may perform its function. If Article 8(2) CDR applies to all the essential features of the Community design, the latter must be declared invalid (decision of 20/11/2007, ICD 2 970).

Proof that a Community design may be objected to based on Article 8(2) CDR rests on the applicant. The applicant must substantiate the existence of the product whose form and dimensions dictate those of the Community design and submit facts, evidence and arguments demonstrating the functions performed by this product and by this Community design individually and/or in combination.

As an exception, Article 8(2) CDR does not apply to a Community design that serves the purpose of allowing the multiple assembly or connection of mutually interchangeable products within a modular system (Article 8(3) CDR). Proof that the Community design serves such a purpose rests on the holder.

5.5 Lack of novelty and individual character

5.5.1 Disclosure of prior design

5.5.1.1 General principles

Challenging the validity of a Community design on account of its lack of novelty or of individual character requires proof that an earlier design that is identical or that produces a similar overall impression has been made available to the public before the date of filing the application for registration or, if a priority is claimed, the date of priority (Articles 5 and 6 CDR).

The public in question is made up of the members of the circles specialised in the sector concerned, operating within the European Union (Article 7(1) CDR).

The term '*circles specialised in the sector concerned*' in the meaning of Article 7(1) CDR is not limited to persons that are involved in creating designs and developing or manufacturing products based on those designs within the sector concerned. Article 7(1) CDR lays down no restrictions relating to the nature of the activity of natural or legal persons who may be considered to form part of the '*circles specialised in the sector concerned*'. Consequently, traders may also form part of the '*specialised circles*' in the meaning of Article 7(1) CDR (see, by way of analogy, judgment of 13/02/2014, C-479/12, Gartenmöbel, EU:C:2014:75, § 27).

For the purpose of Article 7 CDR, a 'design' means the appearance of the whole or a part of a product resulting from the features of, in particular, the lines, contours, colours, shape, texture and/or materials of the product itself and/or its ornamentation (Article 3(a) CDR). Whether or not an earlier 'design' within the meaning of Article 3(a) CDR enjoys legal protection (as a design, as a trade mark, as a copyrighted work, as a utility model or otherwise) is immaterial.

The applicant must substantiate the disclosure of an earlier design.

It is assumed that a design that has been made available to the public anywhere in the world and at any point in time, as a result of publication following registration or otherwise, exhibition, use in trade or otherwise, has been disclosed for the purpose of applying Articles 5 and 6 CDR (Article 7(1) CDR).

However, acts of disclosure of an earlier design will not be taken into consideration where the holder submits convincing facts, evidence and arguments in support of the view that these events could not reasonably have become known in the normal course of business to the circles specialised in the sector concerned, operating within the European Union (Articles 7(1) and 63(1) CDR) (decision of 22/03/2012, R 1482/2009-3, Insulation blocks, § 38).

Other exceptions will be addressed in paragraphs 5.5.1.7 and 5.5.1.8 below.

5.5.1.2 Official publications

Publication of an earlier design in the bulletin of any industrial property office worldwide constitutes disclosure and it is only ('except') where this publication cannot reasonably become known to the circles specialised in the sector concerned within the European Union that the said rule is affected by an exception. Therefore, once proof of publication has been provided by the applicant, disclosure is assumed to have taken place and, considering the globalisation of the markets, it is incumbent on the holder to provide facts, arguments or evidence to the contrary, namely that publication of the earlier design could not reasonably have become known to the circles specialised in the sector concerned, operating within the European Union (decisions of 27/10/2009, R 1267/2008-3, Watches, § 35 et seq; 07/07/2008, R 1516/2007-3, Cans, § 9).

Publications in trademark and patent bulletins could equally have become known in the normal course of business to the circles in the sector concerned operating within the European Union. Therefore, where the appearance of a product has been applied for and published as a trade mark, it is to be considered as a disclosure of a 'design' for the purpose of Article 7 CDR (judgment of 16/12/2010, T-513/09, Ornamentación, EU:T:2010:541, § 20). The same applies where the representations contained in a patent application show the appearance of an industrial or handicraft item (decision of 22/03/2010, R 0417/2009-3, Drinking straws, § 21). However, the presence of a

document kept by a patent and trade mark office, which is available to the public only by means of an application for inspection of files, may not be considered to have become known in the normal course of business to the specialised circles in the sector concerned and therefore does not prove the disclosure of a prior design in the meaning of Article 7 CDR (decisions of 22/03/2012, R 1482/2009-3, Insulation blocks, § 39-43; 15/04/2013, R 0442/2011-3, Skirting Boards, § 26).

In order to substantiate the disclosure, a registration certificate must specify the date of publication independently of the date of filing or the date of registration. The publication in the Official Bulletin of a national Patent Office must be considered as having been disclosed and made available to the public in accordance with Article 7(1) CDR (judgment of 07/11/2013, T-666/11, Gatto domestico, EU:T:2013:584, § 25). Whether or not the publication takes place before or after registration is irrelevant (decision of 15/04/2013, R 0442/2011-3, Skirting Boards, § 24).

Moreover, it is enough that the date of publication can be identified by the mention of an INID code ('Internationally agreed Numbers for the Identification of (bibliographic) Data' as standardised by WIPO Standard ST.9. See decision of the Invalidation Division of 14/11/2006, ICD 2 061).

5.5.1.3 Exhibitions and use in trade

Disclosure of a design at an international exhibition anywhere in the world is an event that may become known in the normal course of business to the circles in the sector concerned, operating within the European Union, except where evidence to the contrary is provided (decisions of 26/03/2010, R 0009/2008-3, Footwear, § 73-82; 01/06/2012, R 1622/2010-3, Lamps, § 24). The question whether events taking place outside the European Union could reasonably have become known to persons forming part of those circles is a question of fact. The answer to that question has to be assessed by OHIM on the basis of the particular circumstances of each individual case (judgment of 13/02/2014, C-479/12, Gartenmöbel, EU:C:2014:75, § 34).

Use in trade is another example given in Article 7(1) CDR as a means for disclosure of a design, irrespective of whether this use is made within or outside the EU (decision of 26/03/2010, R 0009/2008-3, Footwear, § 63-71).

Disclosure of a design can be the result of use in trade even where there is no proof on file that the products in which the earlier design is incorporated have actually been put on the market in Europe. It suffices that the goods have been offered for sale in distributed catalogues (decision of 22/10/2007, R 1401/2006-3, Ornamentation, § 25) or imported from a third country to the European Union (judgment of 14/06/2011, T-68/10, Watches, EU:T:2011:269, § 31-32) or have been the object of an act of purchase between two European operators (judgment of 09/03/2012, T-450/08, Phials, EU:T:2012:117, § 30-45).

As regards the submission of catalogues, their evidential value does not depend on their being distributed to the public at large. Catalogues that are made available to specialised circles only can also be valid means of evidence, bearing in mind that the relevant public for assessing disclosure is the 'circles specialised in the sector concerned' (Article 7(1) CDR).

The extent of, or the circumstances surrounding the distribution of the catalogues can be relevant factors (judgment of 13/02/2014, C-479/12, Gartenmöbel, EU:C:2014:75,

§ 35-36). However, what matters, in the context of Article 7 CDR, is whether the European specialised circles, taken as a whole, have had a reasonable opportunity to have access to the design irrespective of the actual number who seized this opportunity and were eventually confronted with the disclosed design.

The Office makes an overall assessment of all the documents submitted by the invalidity applicant for the purpose of assessing whether disclosure has been made, and including whether a catalogue is genuine and has been disseminated in the interested circles.

It is enough that the disclosure took place at a point in time that can be identified with reasonable certainty prior to the filing date or priority date of the contested Community design even if the exact date of disclosure is unknown (judgment of 14/06/2011, T-68/10, *Watches*, EU:T:2011:269, § 31-32).

5.5.1.4 Disclosures derived from the internet

Information disclosed on the internet or in online databases is considered to be publicly available as of the date the information was published. Internet websites often contain highly relevant information. Certain information may even be available only on the internet from such websites. This includes, for example, online publications of design registrations by industrial property offices.

The nature of the internet can make it difficult to establish the actual date on which information was in fact made available to the public. For instance, not all web pages mention when they were published. In addition, websites are easily updated, yet most do not provide any archive of previously displayed material, nor do they display records that enable members of the public to establish precisely what was published and when.

In this context, the date of disclosure on the internet will be considered reliable in particular where:

- the web site provides time stamp information relating to the history of modifications applied to a file or web page (for example, as available for Wikipedia or as automatically appended to content, e.g. forum messages and blogs); or
- indexing dates are given to the web page by search engines (e.g. from the Google cache); or
- a screenshot of a web page bears a given date; or
- information relating to the updates of a web page is available from an internet archiving service.

Neither restricting access to a limited circle of people (e.g. by password protection) nor requiring payment for access (analogous to purchasing a book or subscribing to a journal) prevents a design on a web page from being found to have been disclosed. When assessing whether such a disclosure could not reasonably have become known in the normal course of business to the circles specialised in the sector concerned, operating within the European Union, aspects such as accessibility and search-ability of that web page can be taken into account.

5.5.1.5 Statements in writing, sworn or affirmed (affidavits)

As a matter of principle, affidavits in themselves are not sufficient to prove a fact such as the disclosure of an earlier design. They may, however, corroborate and/or clarify the accuracy of additional documents (decision of 14/10/2009, R 0316/2008-3, Fireplaces, § 22. See by analogy judgment of 13/05/2009, T-183/08, Jello Schuhpark II, EU:T:2009:156, § 43).

In order to assess the evidential value of an affidavit, regard should be had first and foremost to the credibility of the account it contains. It is then necessary to take account, in particular, of the person from whom the document originates, the circumstances in which it came into being, the person to whom it was addressed and whether, on its face, the document appears sound and reliable (judgment of 09/03/2012, T-450/08, Phials, EU:T:2012:117, § 39-40).

Affidavits and other documentary evidence originating from parties having an interest in having a Community design being declared invalid have a lower probative value compared to documents having a neutral source (judgment of 14/06/2011, T-68/10, Watches, EU:T:2011:269, § 33-36).

The Invalidation Division will apply the principles explained in the Guidelines, Part C, Opposition, Section 6, Proof of Use, paragraph 3.3.2.3, Declarations.

5.5.1.6 Insufficient disclosure

The issue of the disclosure of the prior design is preliminary to that of whether the two designs produce the same overall impression on the informed user. If the prior design has not been made available to the public or it has been made so but in a manner inconsistent with the requirements of Article 7(1) CDR, then there is sufficient reason for rejecting the application to the extent that it is based on Articles 5 and 6 CDR (decision of 10/03/2008, R 0586/2007-3, Barbecues, § 22 et seq).

Neither the CDR nor the CDIR provides for any specific form of evidence required for establishing disclosure, Article 28(1)(b)(v) CDIR only provides that 'documents proving the existence of those earlier designs' must be submitted. Likewise, there are no provisions as to any compulsory form of evidence that must be furnished. Article 65 CDR lists possible means of giving evidence before the Office, but it is clear from its wording that this list is not exhaustive ('shall include the following'). Accordingly, the evidence in support of disclosure is a matter for the discretion of the applicant and, in principle, any evidence able to prove disclosure can be accepted.

The Invalidation Division will carry out an overall assessment of such evidence by taking account of all the relevant factors in the particular case. Disclosure cannot be proven by means of probabilities or suppositions, but must be demonstrated by solid and objective evidence of effective and sufficient disclosure of the earlier design (judgment of 09/03/2012, T-450/08, Phials, EU:T:2012:117, § 21-24).

A global examination of the items of evidence implies that these items must be assessed in the light of each other. Even if some items of evidence are not conclusive of disclosure in themselves, they may contribute to establishing the disclosure when examined in combination with other items (judgment of 09/03/2012, T-450/08, Phials, EU:T:2012:117, § 25 and 30-45).

The Invalidation Division is not required to determine through assumptions and deductions which earlier designs among those represented in the applicant's documentary evidence may be relevant where the applicant does not provide further specifications in this respect (see paragraph 3.9.2 above). Earlier designs, other than those specifically cited as relevant prior designs by the applicant, will therefore be disregarded (decision of 04/10/2006, ICD 2 228).

Where the representation of the prior design fails to represent it adequately, thereby rendering any comparison with the contested design impossible, this does not amount to disclosure for the purpose of Article 7(1) CDR (decision of 10/03/2008, Barbecues, R 0586/2007-3, § 22 et seq.).

It is possible for a disclosure to one undertaking to disclose the design sufficiently to the circles specialised in the sector concerned operating within the European Union. Whether it does or not is a question to be assessed on a case by case basis (judgment of 13/02/2014, C-479/12, Gartenmöbel, EU:C:2014:75, § 35-36).

5.5.1.7 Disclosure to a third person under explicit or implicit conditions of confidentiality

Disclosure of the Community design to a third person under explicit or implicit conditions of confidentiality will not be deemed to have been made available to the public (Article 7(1) CDR).

Therefore, disclosure of a design to a third party in the context of commercial negotiations is ineffective if the parties concerned agreed that the information exchanged should remain secret (decision of 20/06/05, ICD 172, para. 22).

The burden of proof for facts establishing confidentiality lies with the holder of the contested Community design.

5.5.1.8 Disclosure within the priority period

An application for a Community design may claim the priority of one or more previous applications for the same design or utility model in or for any State party to the Paris Convention, or to the Agreement establishing the World Trade Organisation (Article 41 CDR; Article 8 CDIR). The right of priority is six months from the date of filing of the first application.

The effect of the right of priority shall be that the date of priority will count as the date of filing of the application for a registered Community design for the purpose of Articles 5, 6, 7 and 22; Article 25(1)(d) and Article 50(1) CDR (Article 43 CDR).

A priority claim relating to the 'same design or utility model' requires identity with the corresponding Community design without addition or suppression of features. A priority claim is however valid if the Community design and the previous application for a design right or a utility model differ only in immaterial details.

When examining an application for a Community design, the Office does not verify whether this application concerns the 'same design or utility model' whose priority is claimed.

The examination of a priority claim will, however, be carried out by the Office if the applicant challenges its validity or if the holder challenges the effects of the disclosure of a design, for the purpose of Articles 5, 6 and 7 CDR, where this disclosure occurred within the priority period.

Where the validity of the priority claim is determinative of the outcome of the application, the Office may either take position on the validity of this claim in the decision on the merits of the case, or stay the proceedings on its own motion to allow the holder to remedy possible deficiencies within a given time limit (Article 45(2)(d) CDR; Articles 1(1)(f) and 10(3)(c), and Article 10(7) and (8) CDR).

The invalidity proceedings are resumed once the deficiencies are remedied or a final decision is taken on the loss of the right of priority (Article 46(1)(4) CDR) (see paragraph 4.1.6.2 above for the resumption of the proceedings).

5.5.1.9 Grace period

Article 7(2) CDR provides for a 'grace period' of 12 months preceding the date of filing or the priority date of the contested Community design. Disclosure of the Community design within such period will not be taken into consideration if it was made by the designer or its successor in title.

As a matter of principle, the holder must establish that it is either the creator of the design upon which the application is based or the successor in title to that creator, failing which Article 7(2) CDR cannot apply (judgment of 14/06/2011, T-68/10, Watches, EU:T:2011:269, § 26-29).

However, acts of disclosure made by a third person as a result of information provided or action taken by the designer or its successor in title are also covered by Article 7(2) CDR. This can be so where a third party made public a design copied from a design that was previously disclosed within the grace period by the holder itself (decision of 02/05/2011, R 0658/2010-3, Lighting devices, § 37-39).

Article 7(2) CDR also provides for immunity against the loss of *individual character* pursuant to Article 6 CDR (decision of 02/05/2011, R 0658/2010-3 – 'Lighting devices', § 40). The exception provided in Article 7(2) CDR may therefore apply where the previously disclosed design is either identical to the contested Community design, within the meaning of Article 5 CDR, or the previously disclosed design does not produce a different overall impression.

The 'grace period' also applies where the disclosure of a design is the result of an abuse in relation to the designer or its successor in title (Article 7(3) CDR). Whether the disclosure is the result of fraudulent or dishonest behaviour will be assessed on a case-by-case basis on the basis of the facts, arguments and evidence submitted by the parties (decision of 25/07/2009, R 0552/2008-3, MP3 player recorder, § 24-27).

5.5.2 Assessment of novelty and individual character

A design will be protected as a Community design to the extent that it is new and has individual character (Article 4(1), 5 and 6 CDR). The novelty and individual character of a Community design must be examined on its date of filing or, as the case may be, on

its date of priority, in the light of the relevant prior designs. The relevant prior designs are made up of the earlier designs whose disclosure, according to Article 7 CDR, was substantiated by the applicant (Article 63 CDR).

5.5.2.1 Common principles

Global comparison

The Community design must be compared with each and every earlier design relied on by the applicant, individually. Novelty and individual character of a Community design cannot be defeated by combining features taken in isolation and drawn from a number of earlier designs, but by one or more earlier designs, taken individually (judgments of 19/06/2014, C-345/13, Karen Millen Fashions, EU:C:2014:2013, § 23-35; 22/06/2010, T-153/08, Communications equipment, EU:T:2010:248, § 23-24).

A combination of already disclosed features is, therefore, eligible for protection as a Community design provided this combination, as a whole, is novel and has individual character.

As a matter of principle, all the features of a Community design must be taken into consideration when examining its novelty and individual character. There are, however, a number of exceptions to this general principle.

Features dictated by a function and features of interconnection

Features that are solely dictated by a technical function and features that must necessarily be reproduced in their exact form and dimensions in order to allow interconnection with another product cannot contribute to the novelty and individual character of a Community design. Such features must therefore be disregarded when comparing the Community design with the relevant prior designs (Article 8 CDR, see paragraph 5.3.1 above).

The visibility requirement

Features of a Community design applied to, or incorporated in a 'component part of a complex product', will be disregarded if they are invisible during normal use of the complex product in question (Article 4(2) CDR).

'Complex product' means a product that is composed of multiple components that can be replaced, permitting disassembly and reassembly of the product (Article 3(c) CDR). For instance, the visibility requirement does not apply to a Community design representing the appearance of a garbage container as a whole since garbage containers may be complex products as such, but not component parts of complex products (decision of 23/06/2008, ICD 4 919).

'Normal use' means use by the end user, excluding maintenance, servicing or repair work (Article 4(3) CDR). 'Normal use' is the use made in accordance with the purpose for which the complex product is intended.

For instance, for safety reasons, an electrical connector is a component part that is normally incorporated in a casing in order to be shielded from any contact with potential

users when a complex product, such as a train or electric vehicle, is in operation. The fact that such a component part of a complex product can theoretically be made visible when inserted in a transparent casing or cover constitutes a purely hypothetical and random criterion that must be disregarded (decision of 03/08/2009, R 1052/2008-3, Electrical contractors, § 42-53).

Where none of the features of a Community design applied to a component part (e.g. a sealing ring) is visible during normal use of the complex product (e.g. a heat pump system), this Community design will be invalidated as a whole (judgments of 20/01/2015, T-616/13, Heat exchanger inserts, EU:T:2015:30, § 14-16).

However, Article 4(2) CDR does not require a component part to be clearly visible in its entirety at every moment of the use of the complex product. It is sufficient if the whole of the component can be seen some of the time in such a way that all its essential features can be apprehended (decision of 22/10/2009, R 0690/2007-3, Chaff cutters, § 21).

Where the features of a Community design applied to a component part are only partially visible during normal use of the complex product, the comparison with the relevant prior designs invoked must be limited to the visible parts.

Clearly discernible features

Features of the Community design that are not clearly discernible in its graphical representation cannot contribute to its novelty or its individual character (Directive 98/71/EC of the European Parliament and the Council of 13 October 1998 on the legal protection of designs, Recital 11). Likewise, features of the prior design that are not of a sufficient quality allowing all the details to be discerned in the portrayal of the prior design cannot be taken in consideration for the purpose of Articles 5 and 6 CDR (decision of 10/03/2008, R 0586/2007-3, Barbecues, § 23-26).

Features of a prior design can be supplemented by additional features that were made available to the public in different ways, for instance, first, by the publication of a registration and, second, by the presentation to the public of a product incorporating the registered design in catalogues. These representations must however relate to one and the same earlier design (judgment of 22/06/2010, T-153/08, Communication equipment, § 25-30).

Disclaimed features

Features of a Community design that are disclaimed are disregarded for the purposes of comparing the designs. This applies to the features of a Community design represented with dotted lines, boundaries or colouring or in any other manner making clear that protection is not sought in respect of such features (judgment of 14/06/2011, T-68/10, Watches, EU:T:2011:269, § 59-64).

In contrast, disclaimed features of an earlier registered design are taken into account when assessing the novelty and individual character of a contested Community design. In the context of Articles 5 and 6 CDR, it is immaterial whether the holder of the earlier registered design can claim protection for such disclaimed features, provided they have been disclosed together with the earlier design as a whole.

5.5.2.2 Novelty

A Community design will be considered to be new if it is not predated by an identical design disclosed pursuant to Article 7 CDR. Designs will be deemed to be identical if their features differ only in immaterial details (Article 5(2) CDR).

There is identity between the Community design and an earlier design where the latter discloses each and every element constituting the former. The framework of the comparison is limited to the features making up the Community design. It is therefore irrelevant whether the earlier design discloses additional features. A Community design cannot be new if it is included in a more complex earlier design (decision of 25/10/11, R 0978/2010-3, Part of a sanitary napkin, § 20-21).

However, the additional or differentiating features of the Community design may be relevant to decide whether this Community design is new, unless such elements are so insignificant that they may pass unnoticed.

An example of an immaterial detail is a slight variation in the shade of the colour pattern of the compared designs (decision of 28/07/2009, R 0921/2008-3, Nail files, § 25). Another illustration is the display, in one of the two compared designs, of a label that is so small in size that it is not perceived as a relevant feature (decision of 08/11/2006, R 0216/2005-3, Cafetera, § 23-26), as in the following example:

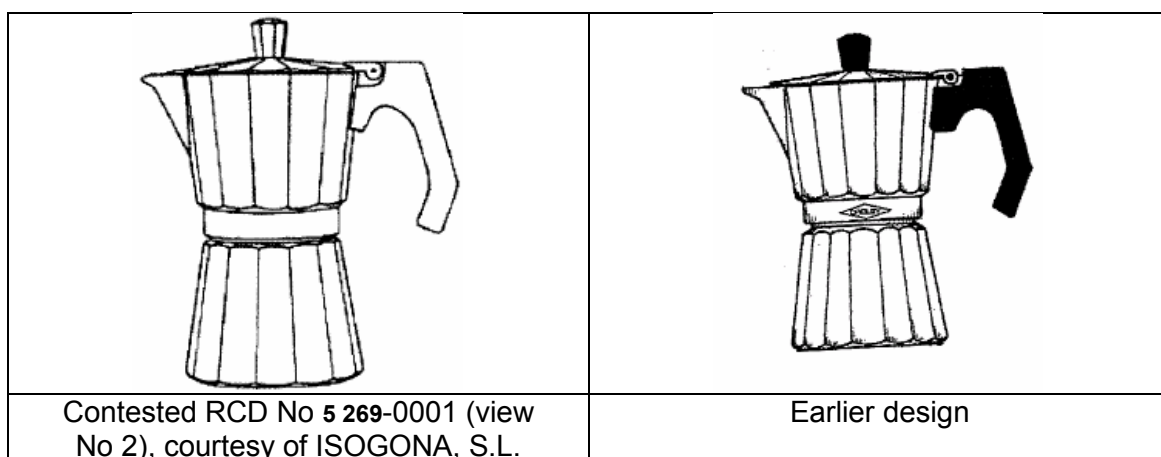

5.5.2.3 Individual character

A design will be considered to have individual character if the overall impression it produces on the informed user differs from the overall impression produced on such a user by any design that has been made available to the public before the date of filing the application for registration or, if a priority is claimed, the date of priority (Article 6(1) CDR).

In assessing individual character, the degree of freedom of the designer in developing the design will be taken into consideration (Article 6(2) CDR).

The informed user

The status of ‘user’ implies that the person concerned uses the product in which the design is incorporated, in accordance with the purpose for which that product is intended (judgments of 22/06/2010, T-153/08, Communications equipment, EU:T:2010:248, § 46; 09/09/2011, T-10/08, Internal combustion engine, EU:T:2011:446, § 24; 06/06/2013, T-68/11, Watch-dials, EU:T:2013:298, § 58).

The concept of ‘informed user’, which refers to a fictitious person, lies somewhere between that of the average consumer, applicable in trade mark matters, who need not have any specific knowledge, and the sectorial expert, who is an expert with detailed technical expertise. Without being a designer or a technical expert (and therefore without necessarily knowing which aspects of the product concerned are dictated by technical function, as found in judgment of 22/06/2010, T-153/08, Communication equipment, EU:T:2010:248, § 48) the informed user is aware of the various designs that exist in the sector concerned, he possesses a certain degree of knowledge with regard to the features that those designs normally include, and, as a result of his interest in the products concerned, he shows a relatively high degree of attention when he uses them (judgments of 20/10/2011, C-281/10 P, Metal rappers, EU:C:2011:679, § 53 and 59; T-153/08, Communications equipment, EU:T:2010:248, § 47; 06/06/2013, T-68/11, Watch-dials, EU:T:2013:298, § 59).

In other words, the informed user is neither a designer nor a technical expert. Therefore, an informed user is a person having some awareness of the existing designs in the sector concerned, without necessarily knowing which aspects of that product are dictated by technical function.

The informed user is neither a manufacturer nor a seller of the products in which the designs at issue are intended to be incorporated (judgment of 09/09/2011, T-10/08, Internal combustion engine, EU:T:2011:446, § 25-27).

However, depending on the nature of the product in which the Community design is incorporated (e.g. promotional items), the concept of informed user may include, firstly, a professional who acquires such products in order to distribute them to the final users and, secondly, those final users themselves (judgment of 20/10/2011, C-281/10 P, Metal rappers, EU:C:2011:679, § 54). The fact that one of the two groups of informed users perceives the designs at issue as producing the same overall impression is sufficient for a finding that the contested design lacks individual character (judgment of 14/06/2011, T-68/10, Watches, EU:T:2011:269, § 56).

When the nature of the product in which the compared designs are incorporated makes it possible, the overall impression left by these designs will be assessed on the assumption that the informed user can make a direct comparison between them (judgment of 18/10/2012, joint cases C-101/11 P and C-102/11 P, Ornamentation, EU:C:2012:641, § 54-55).

The overall impression

Unless the compared designs include functional or invisible or disclaimed features (see paragraph 5.5.2.1 above), the two designs must be compared globally. That does not mean, however, that the same weight should be given to all the features of the compared designs.

First, the informed user uses the product in which the design is incorporated, in accordance with the purpose for which that product is intended. The relative weight to give to the features of the compared designs may therefore depend on how that product is used. In particular, the role played by some features may be less important depending on their reduced visibility when the product is in use (judgments of 22/06/2010, T-153/08, EU:T:2010:248, § 64-66 and 72; 21/11/2013, T-337/12, Sacacorchos, EU:T:2013:601, § 45-46; 04/02/2014, T-339/12, Armchairs, EU:T:2014:54, § 30; 04/02/2014, T-357/12, Armchairs, EU:T:2014:55, § 57).

Second, when appraising the overall impression caused by two designs, the informed user will only give minor importance to features that are totally banal and common to the type of product in issue and will concentrate on features that are arbitrary or different from the norm (judgments of 18/03/2010, T-9/07, Metal rappers, EU:T:2010:96, § 77; 28/11/2006, R 1310/2005-3, Galletas, § 13; decision of 30/07/2009, R 1734/2008-3, Forks, § 26 et seq.).

Third, similarities affecting features in respect of which the designer enjoyed a limited degree of freedom will have only minor importance in the overall impression produced by those designs on the informed user (judgment of 18/03/2010, T-9/07, Metal rappers, EU:T:2010:96, § 72).

Fourth, when familiar with a saturation of the prior art due to the density of the existing design corpus, the informed user may be more sensitive to even minor differences between the designs that thus may produce a different overall impression (judgments of 13/11/2012, T-83/11 & T-84/11, Radiatori per riscaldamento, EU:T:2012:592, § 81; 12/03/2014, T-315/12, Radiatori per riscaldamento, EU:T:2014:115, § 87). In order to prove an actual impact of such saturation on the informed user's perception, the holder of the contested RCD must present sufficient evidence of the existing design corpus and its density at the date of filing of the contested RCD or its priority date (decisions of 10/10/2014, R 1272/2103-3, Radiator I, § 36, 47; 9/12/2014, R 1643/2014-3, § 51).

As illustration, it was held that the RCD No 1 512 633-0001 created an overall impression that is different from that produced by the earlier design (RCD No 52 113-0001). In an area in which the designer's degree of freedom in developing his or her design is not limited by any technical or legal restraints, the General Court upheld the decision of the Board of Appeal, which found that the differentiating features of the two designs below prevailed over their common points. In particular, the fact that the armchair of the prior design has a rectangular rather than square shape, that its seat is placed lower and that the arms are broader, was considered decisive in support of the conclusion that the contested RCD had individual character (judgment of 04/02/2014, T-339/12, Armchairs, EU:T:2014:54, § 23-37).

According to the GC, account must be taken of the difference between the designs at issue as regards the angle of the backrest and the seat of the armchair represented in the contested design, bearing in mind that the overall impression produced on the informed user must necessarily be determined in the light of the manner in which the product in question is used. Since an inclined backrest and seat will give rise to a different level of comfort from that of a straight back and seat, the use that will be made of that armchair by the circumspect user is liable to be affected thereby (judgment of 04/02/2014, T-339/12, Armchairs, EU:T:2014:54, § 30).

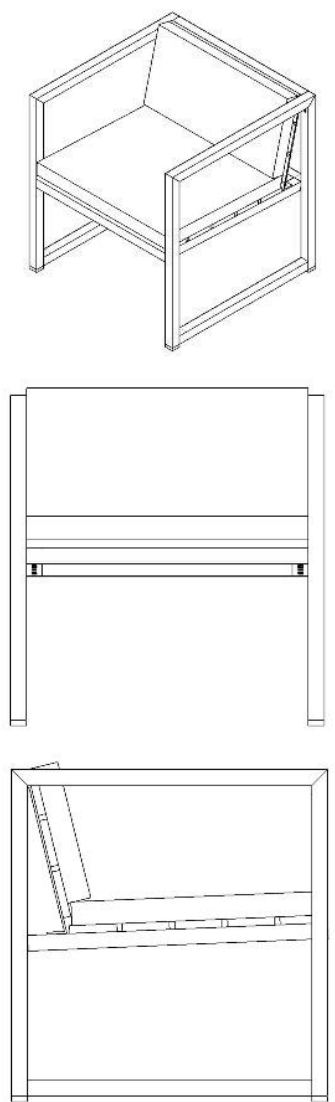
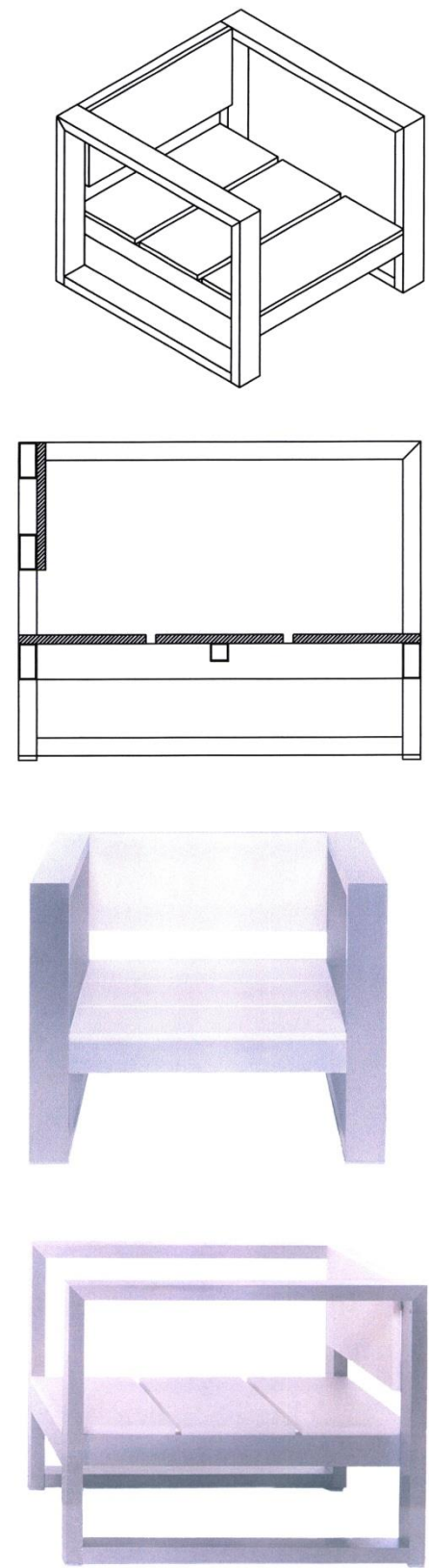
	
<p>Contested RCD No 1 512 633-0001, courtesy of Sachi Premium – Outdoor Furniture, Lda.</p>	<p>Earlier RCD No 52 113-0001, courtesy of Mr Esteve Cambra (Designer: Mr Jose Ramón Esteve Cambra)</p>

By contrast, the GC found that the RCD No 1512633-0003 lacked individual character in respect of the same earlier design. It was held that the differentiating features between the designs, including the presence in the contested RCD of three cushions, were outweighed by their common characteristics (the rectangular shape, the flat back and seat, the seats positioned below the mid-section of the armchairs' structure etc.) (judgment of 04/02/2014, T-357/12, Armchairs, EU:T:2014:54, § 44-60).

The GC confirmed the view taken by the Board of Appeal (decision of 27/04/2012, R 0969/2011-3, Armchairs) that the cushions are less important than the structure of the armchairs when assessing the overall impression caused by the designs because the cushions are not a fixed element but can be easily separated from the main product and because they are often sold and purchased separately, at a relatively low cost compared to that of the structure of an armchair. The informed user perceives the cushions as a mere optional accessory. They can hardly be considered to be 'a significant part of the design'. Consequently the overall impression produced by the designs at issue is dominated by the structure of the armchairs itself and not by the cushions, which could be regarded as secondary elements (judgment of 04/02/2014, T-357/12, Armchairs, EU:T:2014:54, § 37-38).

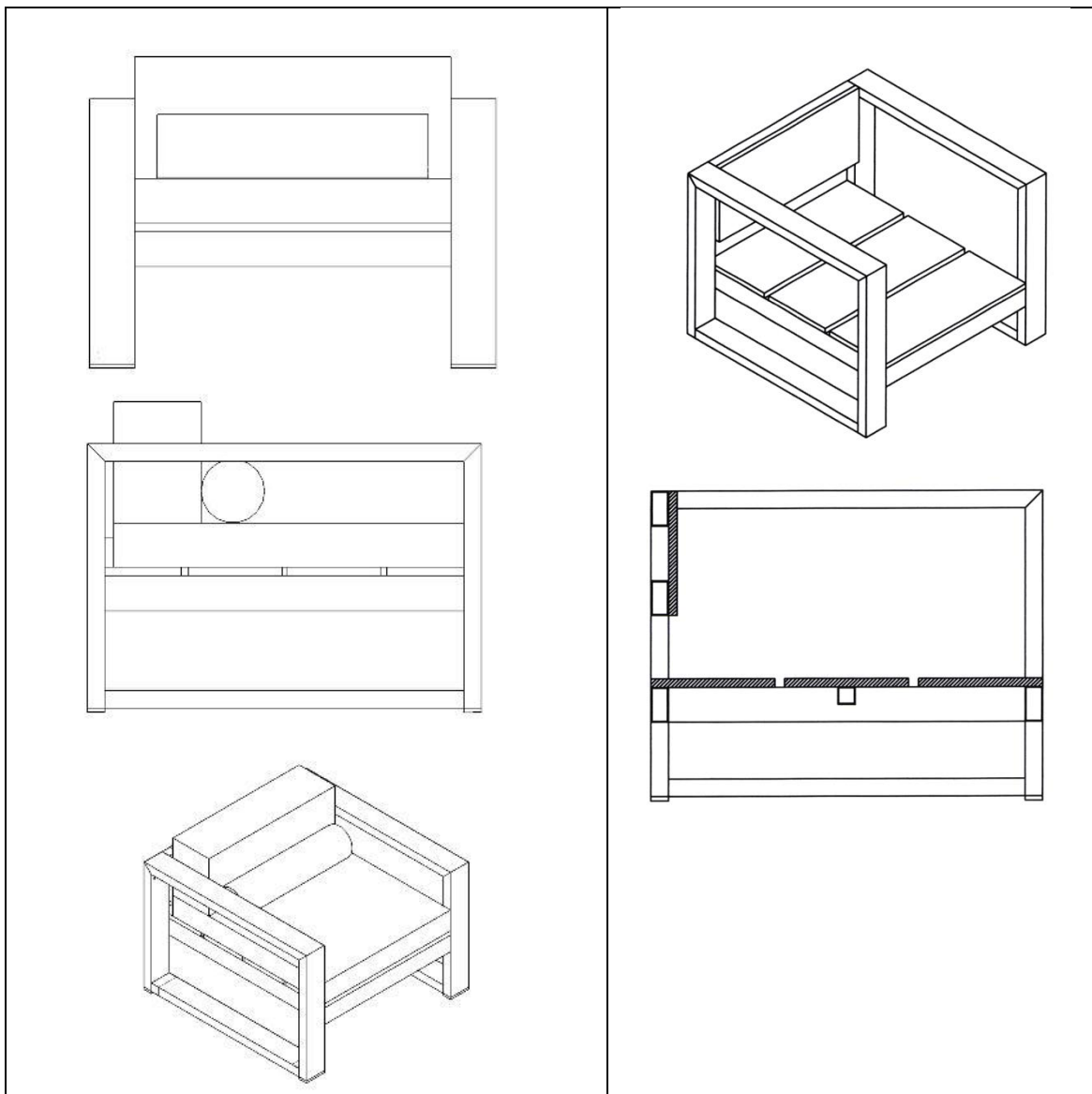

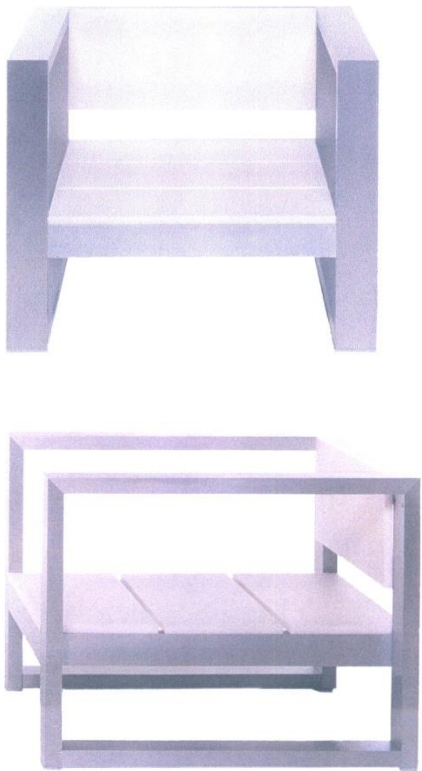
	
<p>Contested RCD No 1 512 633-0003, courtesy of Sachi Premium – Outdoor Furniture, Lda.</p>	<p>Earlier RCD No 52 113-0001, courtesy of Mr Esteve Cambra (Designer: Mr Jose Ramón Esteve Cambra)</p>

The degree of freedom of the designer

The designer’s degree of freedom depends on the nature and intended purpose of the product in which the design will be incorporated, as well as on the industrial sector to which this product belongs. The Invalidity Division will take into account the indication of the products in which the design is intended to be incorporated or to which it is intended to be applied (Article 36(2) CDR), but also the design itself, in so far as it makes clear the nature of the product, its intended purpose or its function (judgment of 18/03/2010, T-9/07, Metal rappers, EU:T:2010:96, § 56).

The designer’s degree of freedom in developing its design is established, inter alia, by the constraints of the features imposed by the technical function of the product or an element thereof, or by statutory requirements applicable to the product. Those constraints result in a standardisation of certain features, which will thus be common to the designs applied to the product concerned (judgments of 13/11/2012, T-83/11 & T-84/11, Radiatori per riscaldamento, EU:T:2012:592, § 44).

The greater the designer’s freedom in developing the challenged design, the less likely it is that minor differences between the designs at issue will be sufficient to produce a different overall impression on an informed user. Conversely, the more the designer’s freedom in developing the Community design is restricted, the more likely minor differences between the designs at issue will be sufficient to produce a different overall impression on the informed user (judgment of 18/03/2010, T-9/07, Metal rappers, EU:T:2010:96, § 67 and 72). Therefore, if the designer enjoys a high degree of

freedom in developing a design, that reinforces the conclusion that the designs that do not have significant differences produce the same overall impression on an informed user (judgment of 09/09/2011, T-10/08, Internal combustion engine, EU:T:2011:446, § 33).

The fact that the intended purpose of a given product requires the presence of certain features may not imply a restricted degree of freedom of the designer where the parties submit evidence that there are possibilities of variations in the positioning of such features and in the general appearance of the product itself (judgments of 14/06/2011, T-68/10, Watches, EU:T:2011:269, § 69; 06/10/2011, T-246/10, Reductores, EU:T:2011:578, § 21-22; 09/09/2011, T-10/08, Internal combustion engine, EU:T:2011:446, § 37).

The degree of freedom of the designer is not affected by the fact that similar designs co-exist on the market and form a 'general trend' or co-exist on the registers of Industrial Property Offices (judgment of 22/06/2010, T-153/08, Communications equipment, EU:T:2010:248, § 58; decision of 01/06/2012, R 0089/2011-3, Corkscrews, § 27).

5.6 Conflict with a prior design right

Pursuant to Article 25(1)(d) CDR, a Community design will be declared invalid if it is in conflict with a prior design that has been made available to the public after the date of filing of the application or, if priority is claimed, the date of priority of the Community design, and which is protected from a date prior to the said date:

1. by a registered Community design or an application for such a design; or
2. by a registered design right of a Member State or by an application for such a right; or
3. by a design right registered under the Geneva Act of the Hague Agreement concerning the international registration of industrial designs, adopted in Geneva on 02/07/1999, hereinafter referred to as 'the Geneva Act', which was approved by Council Decision 954/2006 and which has effect in the Community, or by an application for such a right.

Article 25(1)(d) CDR must be interpreted as meaning that a Community design is in conflict with a prior design when, taking into consideration the freedom of the designer in developing the Community design, that design does not produce on the informed user a different overall impression from that produced by the prior design relied on (judgment of 18/03/2010, T-9/07, Metal rappers, EU:T:2010:96, § 52).

When dealing with an application based on Article 25(1)(d) CDR, the Invalidity Division will therefore apply the same test as for the assessment of individual character under Article 25(1)(b) read in combination with Article 6 CDR.

The Invalidity Division will assume that the prior design is valid unless the holder submits proof that a decision that has become final declared the prior design invalid before the adoption of the decision (see by analogy, judgment of 29/03/2011, C-96/09P, Bud, EU:C:2011:189, § 94-95) (see paragraph 4.1.6.2, Suspension, above).

5.7 Use of an earlier distinctive sign

A Community design will be declared invalid if a distinctive sign is used in a subsequent design, and the law of the Union or the law of the Member State governing that sign confers on the holder of the sign the right to prohibit such use (Article 25(1)(e) CDR).

5.7.1 Distinctive sign

The notion of 'distinctive sign' encompasses registered trade marks as well as all signs that could be relied on in the context of Article 8(4) CTMR (see the Guidelines, Part C, Opposition, Section 4, Rights under Article 8(4) CTMR, paragraph 3.2, Types of rights falling under Article 8(4) CTMR).

5.7.2 Use in a subsequent design

The notion of 'use in a subsequent design' does not necessarily presuppose a full and detailed reproduction of the earlier distinctive sign in a subsequent Community design. Even though the Community design may lack certain features of the earlier distinctive sign or may have different additional features, this may constitute 'use' of that sign, particularly where the omitted or added features are of secondary importance and are unlikely to be noticed by the relevant public. It is enough that the Community design and the earlier distinctive sign be similar (judgments of 12/05/2010, T-148/08, Instruments for writing, EU:T:2010:190, § 50-52; 25/04/2013, T-55/12, Cleaning device, EU:T:2013:219, § 23; decision of 09/08/11, R 1838/2010-3, Instrument for writing, § 43).

Where a Community design includes a distinctive sign without any disclaimer making clear that protection is not sought in respect of such feature, it will be considered that the Community design makes use of the earlier distinctive sign even if the latter is represented in only one of the views (decision of 18/09/2007, R 0137/2007-3, Containers, § 20).

5.7.3 Substantiation of the application under Article 25(1)(e) CDR (earlier distinctive signs)

Apart from the elements mentioned above under paragraph 3.9.2, pursuant to Article 28(1)(b)(vi) CDR an application must contain:

- particulars establishing the content of the law of the national law of which the applicant is seeking application including, where necessary, court decisions and/or academic writings (the principles established in the Guidelines, Part C, Opposition, Section 4, Rights under Article 8(4) CTMR, paragraph 4, Proof of the Applicable Law Governing the Sign, will apply). Where an application for invalidity is based on the rights held on an earlier Community trade mark, the submission of the law and case-law relating to Community trade marks is not a requirement for the substantiation of this earlier right; the same applies if the applicant invokes a likelihood of confusion with an earlier national registered mark; and

- where the earlier distinctive sign is unregistered, particulars showing that rights have been acquired on this unregistered distinctive sign pursuant to the law relied on, as a result of use or otherwise, before the filing date or the priority date of the Community design (see, by analogy, judgment of 18/01/2012, T-304/09, BASmALI, EU:T:2012:13, § 22); and
- particulars showing that the applicant satisfies the necessary conditions, in accordance with that law, in order to be able to have the use of a Community design prohibited by virtue of its earlier right (see by analogy, judgment of 05/07/2011, C-263/09 P, Elio Fiorucci, EU:C:2011:452, § 50).

The applicant must establish only that it has available a right to prohibit use of the subsequent Community design and that it cannot be required to establish that that right has been exercised, in other words that the applicant has actually been able to prohibit such use (see by analogy, judgment of 29/03/2011, C-96/09 P, BUD / Bud, EU:C:2011:189, § 191).

5.7.4 Examination by the Invalidation Division

Where the national provision relied on by the applicant represents the transposition of a corresponding provision of Directive 2008/95/EC of 22 October 2008 to approximate the laws of the Member States relating to trade marks (codified version), the former will be interpreted in the light of the case-law relating to the interpretation of the latter (judgment of 12/05/2010, T-148/08, Instruments for writing, EU:T:2010:190, § 96).

Furthermore, where the national provision relied on represents the transposition of Article 5(1) and (2) of Directive 2008/95/EC, the Invalidation Division will apply the principles established in the Guidelines, Part C, Opposition, Section 2, Double identity and Likelihood of Confusion, and Section 5, Trade Marks with Reputation, since Article 5(1) and (2) of Directive 2008/95/EC is identical in substance to Article 8(1) and (5) CTMR.

For the purpose of applying these provisions, the Invalidation Division will assume that the contested Community design will be perceived by the relevant public as a sign capable of being used 'for' or 'in relation to' goods or services (judgments of 12/05/2010, T-148/08, Instruments for writing, EU:T:2010:190, § 107; 25/04/2013, T-55/12, Cleaning devices, EU:T:2013:219, § 39 and 42).

The Invalidation Division will also assume that the earlier distinctive sign is valid unless the holder submits proof that a decision that has become final declared this earlier distinctive sign invalid before the adoption of the decision (judgment of 25/04/2013, T-55/12, Cleaning devices, EU:T:2013:219, § 34) (see above paragraph 4.1.6.2, Suspension).

As distinctive signs are protected for certain goods or services, the Invalidation Division will examine for which goods the contested Community design is intended to be used (judgment of 12/05/2010, T-148/08, Instruments for writing, EU:T:2010:190, § 108). For the purpose of determining whether these goods and services are identical or similar, the Invalidation Division will take into account the indication of the products in which the design is intended to be incorporated or to which it is intended to be applied (Article 36(2) CDR), and also the design itself, insofar as it makes clear the nature of the product, its intended purpose or its function (judgment of 18/03/2010, T-9/07, Metal rappers, EU:T:2010:96, § 56; decision of 07/11/11, R 1148/2010-3, Packaging,

§ 34-37). The assessment of the similarity of the goods will be made on the basis of the principles defined in the Guidelines, Part C, Opposition, Section 2, Identity and Likelihood of Confusion, Chapter 2, Comparison of Goods and Services).

Where the Community design is intended to be incorporated in two-dimensional 'logos', the Invalidation Division will consider that such logos may be applied to an infinite range of products and services, including the products and services in respect of which the earlier distinctive sign is protected (decision of 03/05/2007, R 0609/2006-3, logo MIDAS, § 27).

5.8 Unauthorised use of a work protected under the copyright law of a Member State

A Community design will be declared invalid if it constitutes an unauthorised use of a work protected under the copyright law of a Member State.

5.8.1 Substantiation of the application under Article 25(1)(f) CDR (earlier copyright)

Apart from the elements mentioned under paragraph 3.9.2 above, pursuant to Article 28(1)(b)(vi) CDR an application must contain:

- particulars establishing the content of the national law of which the applicant is seeking application including, where necessary, court decisions and/or academic writings (see, by analogy, judgment of 05/07/2011, C-263/09 P, Elio Fiorucci, EU:C:2011:452, § 50; decision of 11/02/2008, R 0064/2007-3, Loudspeakers, § 20); and
- particulars showing that rights have been acquired on the work pursuant to the copyright law relied on, to the benefit of the author or its successors in title, before the filing date or the priority date of the Community design (see, by analogy, judgment of 18/01/2012, T-304/09, BASmALI, EU:T:2012:13, § 22); and
- particulars showing that the applicant satisfies the necessary conditions, in accordance with that law, in order to be able to have the Community design invalidated or its use prohibited by virtue of its earlier right.

An invalidity applicant relying on copyright infringement has to prove its entitlement to the right to invoke copyright against the RCD as well as the existence and scope of the copyright under national law (decision of 17/10/2013, R 0951/2012-3, Children's chairs).

5.8.2 Examination by the Invalidation Division

Given that copyright protection may not, according to the national law relied on, depend on the publication or disclosure of the work, the Invalidation Division will only declare a Community design invalid under Article 25(1)(f) CDR in the clearest of cases.

In particular, it would not be appropriate to use Article 25(1)(f) CDR when the applicant's essential argument is that the Community design was created, not by the

registered holder, but by the applicant or by an employee of the applicant (decision of 11/02/2008, R 0064/2007-3, Loudspeakers, § 20). Article 25(1)(f) CDR cannot be used as a means to circumvent the exclusive competence of national courts regarding the entitlement to the Community design (Article 15 and 25(1)(c) CDR).

The object of the examination is to ascertain whether an unauthorised use of a work protected by the copyright legislation of a member state has occurred and not to establish whether the design possesses novelty or individual character in the sense of Articles 5 and 6 CDR (see by analogy judgments of 23/10/2013, T-566/11 & T-567/11, Vajilla, EU:T:2013:549, § 73).

5.9 Partial invalidity

According to Article 25(6) CDR, a registered Community design that has been declared invalid pursuant to any of the grounds under Article 25(1)(b), (e), (f) or (g) CDR may be maintained in an amended form, if in that form it complies with the requirements for protection and the identity of the design is retained.

The request for maintenance in an amended form of a registered Community design must be made by the holder before the end of the written procedure. The request must include the amended form. The proposed amended form may consist of an amended representation of the Community design from which some features are removed or making clear by means inter alia of dotted lines or colouring that protection is not sought in respect of such features. The amended representation may include a partial disclaimer not exceeding 100 words (Article 25(6) CDR; Article 18(2) CDR).

The applicant will be given an opportunity to comment on whether the Community design in its amended form complies with the requirements for protection and whether the identity of the design is retained (see paragraph 4.1.4.1 above).

The identity of the Community design must be retained. Maintenance in an amended form will therefore be limited to cases in which the features removed or disclaimed do not contribute to the novelty or individual character of a Community design, in particular:

- where the Community design is incorporated in a product that constitutes a component part of a complex product and the removed or disclaimed features are invisible during normal use of this complex product (Article 4(2) CDR); or
- where the removed or disclaimed features are dictated by a technical function or by interconnection purposes (Article 8(1) and (2) CDR); or
- where the removed or disclaimed features are so insignificant in view of their size or importance that they are likely to pass unnoticed in the perception of the informed user.

The decision to maintain the Community design in an amended form will be included in the decision on the merits terminating the invalidity proceedings.

5.10 Grounds of invalidity that become applicable merely because of the accession of a new Member State

See the Guidelines, Examination of Applications for Registered Community Designs, paragraph 13, Enlargement and the Registered Community Design.

6 Termination of the Proceedings

6.1 Termination of proceedings without a decision on the merits

The invalidity proceedings are terminated without a decision on the merits, where:

1. the applicant withdraws its application as a result of an amicable settlement or otherwise; or
2. the holder surrenders the Community design in its entirety and the applicant did not request the Office to adopt a decision on the merits of the case (Article 24(2) CDR; see paragraph 3.8); or
3. the contested Community design has lapsed and the applicant did not request the Office to adopt a decision on the merits of the case (Article 24(2) CDR; see paragraph 3.8 above); or
4. the Invalidation Division suspended a number of applications for a declaration of invalidity, relating to the same registered Community design. These applications will be deemed to be disposed of once a decision declaring the invalidity of the Community design has become final (Article 32(3) CDIR).

The Invalidation Division informs the parties that the proceedings are terminated without a decision on the merits.

6.2 Decision on costs

6.2.1 Cases where a decision on costs must be taken

If a decision on the merits of the case is taken, the decision on apportionment of costs is given at the end of the decision (Article 79(1) CDIR).

In all other cases where the Invalidation Division closes the case without a decision on the merits, a separate decision on costs is issued on request by any of the parties. In such a case, the Invalidation Division informs both parties when it will render a decision on costs. The parties may submit arguments on the apportionment of the costs.

6.2.2 Cases where a decision on costs is not to be taken

6.2.2.1 Agreement on costs

Whenever the parties inform the Invalidation Division that they have settled the invalidity proceedings with an agreement that includes the costs, the Invalidation Division will not issue a decision on costs (Article 70(5) CDR).

If no indication is given as to whether the parties have agreed on the costs, the Invalidity Division will take a decision on costs, together with the confirmation of the withdrawal of the application. If the parties inform the Invalidity Division that they had reached an agreement on costs after the withdrawal of the application, the already issued decision on costs will not be revised by the Invalidity Division. It is, however, left to the parties to respect the agreement and not to enforce the Invalidity Division's decision on costs.

6.2.2.2 Apportionment of costs

The general rule is that the losing party, or the party who terminates the proceedings by surrendering the Community design or by maintaining it in an amended form or by withdrawing the application, must bear the fees incurred by the other party as well as all costs incurred by it essential to the proceedings (Article 70(1) and (3) CDR).

If both parties lose in part, a 'different apportionment' has to be decided (Article 70(2) CDR). As a general rule, it is equitable for each party to bear its own costs.

Where a number of applications for a declaration of invalidity relating to the same registered Community design have been suspended, they are deemed to be disposed of once a decision declaring the invalidity of the Community design has become final. Each applicant whose application is deemed to have been disposed of will bear its own costs (Article 70(4) CDR). In addition, the Office will refund 50 % of the invalidity fee (Article 32(4) CDIR).

6.2.2.3 Fixing of costs

Recoverable costs regarding representation and fees

Where the costs are limited to representation costs and the application fee, the decision fixing the amount of costs will be included in the decision on the apportionment of the costs.

The amount to which the winning party is entitled to claim is mentioned in Article 70(1) CDR and Article 79(6) and (7) CDIR.

As regards fees, the recoverable amount is limited to the invalidity fee of EUR 350 if the applicant wins.

As regards representation costs, the recoverable amount is limited to EUR 400. This applies both to the applicant and the holder, under the condition that it was represented in the invalidity proceedings by a professional representative within the meaning of Article 77 CDR. The winning party who is no longer represented by a professional representative at the time of taking a decision is also entitled to an award of costs regardless of the stage of the proceedings when professional representation ceased. This is without prejudice to the need to appoint a professional representative where it is mandatory. The amount to be borne by the losing party is always fixed in euros, regardless of the currency in which the winning party had to pay its representative.

Representation costs for employees, even from another company with economic connections, are not recoverable.

Other recoverable costs

Where the costs include expenses in relation to an oral hearing or the taking of evidence, the registry of the Invalidation Division will, on request, fix the amount of the costs to be paid (Article 70(6) CDR). A bill of costs, with supporting evidence, must be attached to the request for the fixing of costs (Article 79(3) CDIR).

The amount of recoverable costs may be reviewed by a decision of the Invalidation Division on a reasoned request filed within one month of the date of notification of the awarding of costs (Article 70(6) CDR; Article 79(4) CDIR).

Fixing of costs after remittance of the case to the Invalidation Division for further prosecution

When the invalidity decision has been annulled, wholly or partly, and the case is remitted by the Boards of Appeal, the situation will be as follows:

- the first decision (which was appealed) has not become final, even not as regards apportionment or fixing of costs;
- as regards the costs of the invalidity proceedings, one single decision on the apportionment and on the fixing of costs must be taken for the invalidity procedure as a whole;
- as regards the costs of the appeal procedure, it has to be ascertained whether the Boards adjudicated on them. The notion of 'winning party' has to be applied to the outcome of the appeal proceedings with the result that the decision can be different for the two instances. The amount of reimbursable representation costs for the appeal procedure is EUR 500, which apply in addition to the representation costs for the invalidity proceedings.

6.3 Correction of mistakes and entry in the Register

6.3.1 Correction of mistakes

In decisions of the Invalidation Division, only linguistic errors, errors of transcription and obvious mistakes may be corrected. They will be corrected by the Invalidation Division, acting of its own motion or at the request of an interested party (Article 39 CDIR).

6.3.2 Entry into the Register

The date and content of the decision on the application or any other termination of proceedings will be entered into the Register once it is final (Article 53(3) CDR, Article 69(3)(q) CDIR).

7 Appeal

7.1 Right to appeal

Any party to invalidity proceedings has the right to appeal against a decision that affects this party adversely. A decision that does not terminate proceedings as regards one of the parties can only be appealed together with the final decision, unless the decision allows separate appeal. Any written communication of such a decision will include a notice that the decision may be appealed within two months from the date of receipt of the notification of the decision. Appeals have suspensive effect (Article 55 CDR).

7.2 Interlocutory revision

Revision can be granted where an appeal has been lodged against a decision for which the Boards of Appeal are competent pursuant to Article 55 CDR.

If the department whose decision is appealed considers the appeal to be admissible and well founded, it shall rectify its decision. However, this shall not apply where the appellant is opposed by other parties to the proceedings (Article 58(1) CDR). Therefore, a revision can only be granted if the application for declaration of invalidity is rejected as inadmissible (or deemed not to have been filed) pursuant to Article 30 CDR.

If the decision is not rectified within one month after receipt of the statement of grounds of the appeal, the appeal will be remitted to the Boards of Appeal without delay, and without comment as to its merits (Article 58(2) CDR).

The principles applying to revision in respect of decisions adopted by the Opposition Division apply *mutatis mutandis* to the decisions adopted by the Invalidation Division in the admissibility examination of the application (see the Guidelines, Part A, General Rules, Section 7, Revision).